

CARDOSO  
2521-23(S.ÁGY)+  
4010(FIX)+  
2021-23(AT)

**D** MONTAGEANLEITUNG  
BEDIENUNGSANLEITUNG

**NL** HANDLEIDING VOOR DE MONTAGE  
GEBRUIKSAANWIJZING

**TR** MONTAJ TALIMATI  
KULLANIM KLAVUZU

**RO** INSTRUCȚIUNI DE INSTALARE  
INSTRUCȚIUNI DE UTILIZARE

**FR** NOTICE DE MONTAGE  
MANUEL INSTRUCTIONS

**HU** SZERELÉSI UTASÍTÁSOK  
KEZELÉSI UTASÍTÁS

**SI** NAVODILA ZA MONTAŽO  
NAVODILA ZA UPORABO

**ES** INSTRUCCIONES DE MONTAJE  
MANUAL DEL USUARIO

**GB** ASSEMBLY INSTRUCTIONS  
INSTRUCTION MANUAL

**PL** INSTRUKCJA MONTAŻU  
INSTRUKCJA OBSŁUGI

**RU** ИНСТРУКЦИЯ ПО МОНТАЖУ  
ИНСТРУКЦИЯ ПО ЭКСПЛУАТАЦИИ

**IT** ISTRUZIONI DI MONTAGGIO  
MANUALE DI ISTRUZIONI

**SK** MONTÁŽNY NÁVOD  
NÁVOD NA POUŽITIE

**CZ** MONTÁŽNÍ NÁVOD  
NÁVOD K POUŽITÍ

**PT** INSTRUÇÕES DE MONTAGEM  
MANUAL DO USUÁRIO

**HR** UPUTE ZA MONTAŽU  
UPUTE ZA UPOTREBU

Service · Dienstverlening · Servis · Servis · Сервисная служба · Serviciu · Services · Servizio  
 ·Servisný list · Szolgáltatás · Servisní list

Name · Naam · Nazwa · İsim · Название · Nume · Nome · Názov · Názov ·  
 Název · Neve  
**CARDOSO**  
 Typ · Type · Tip · Тип · Tipo · Típus

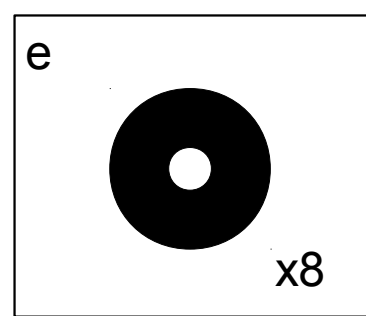
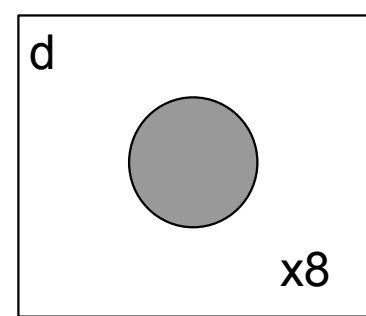
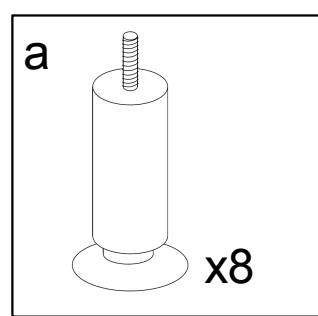
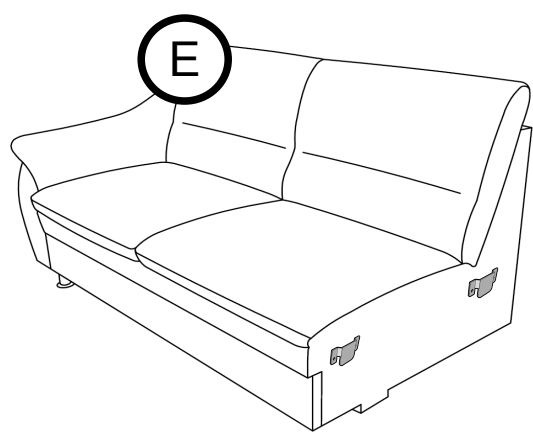
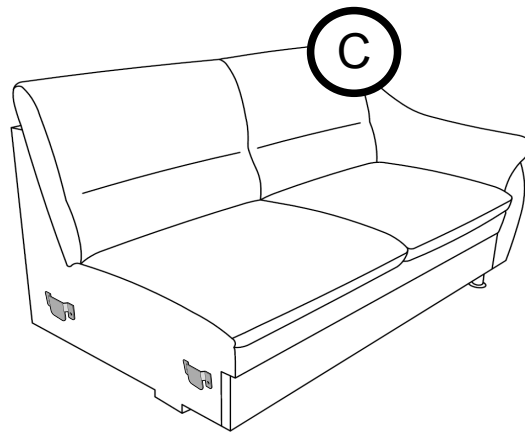
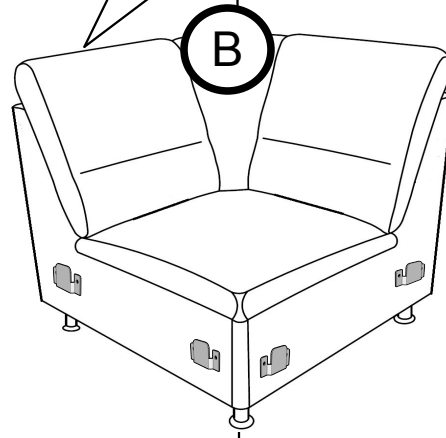
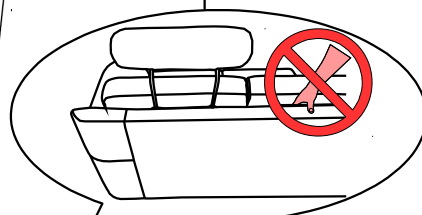
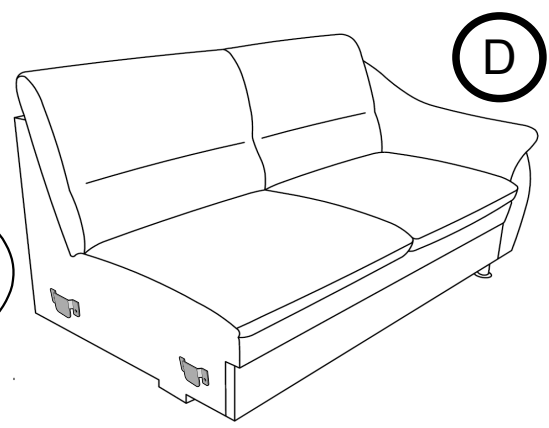
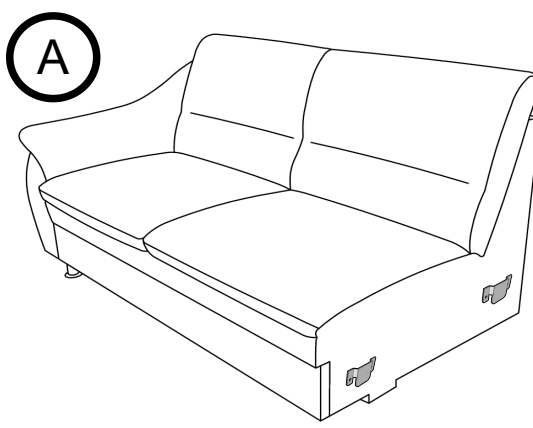
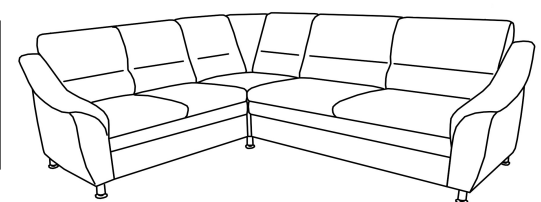
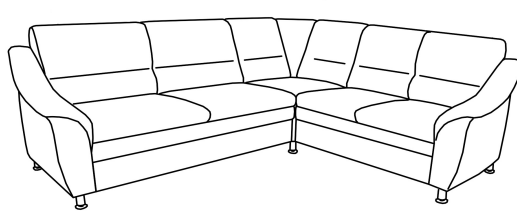
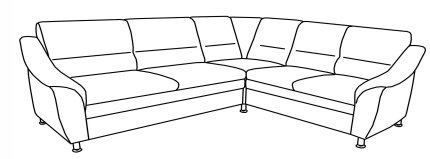
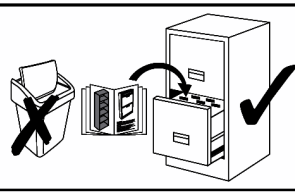

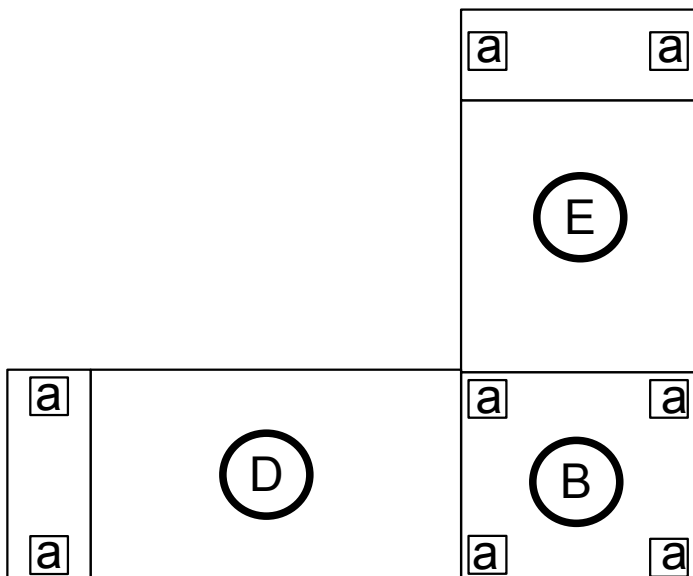
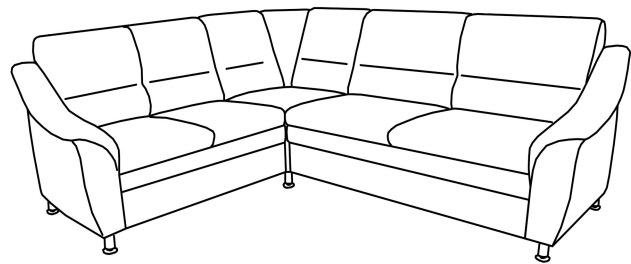
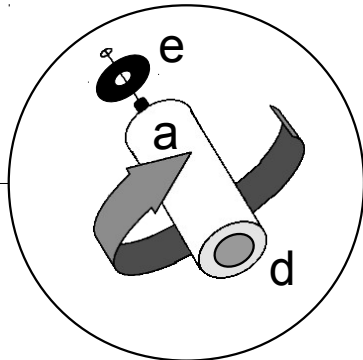
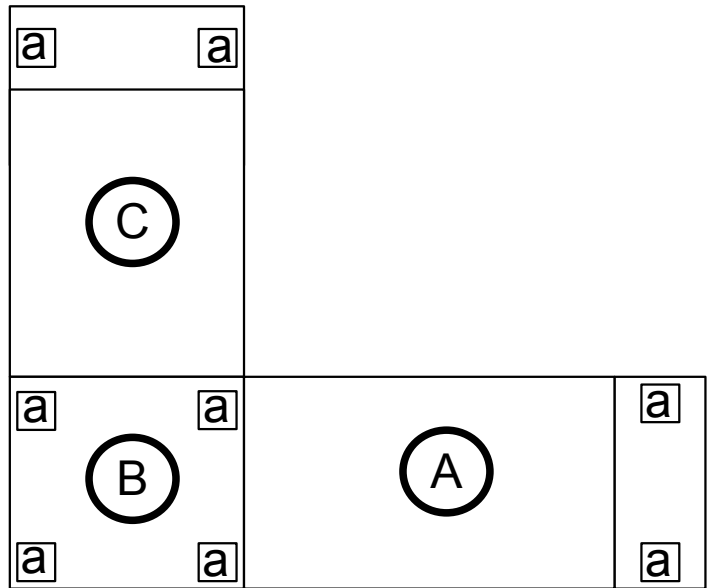
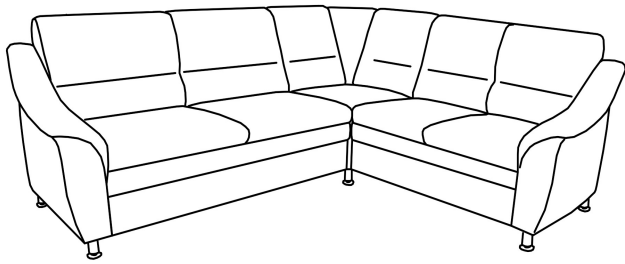
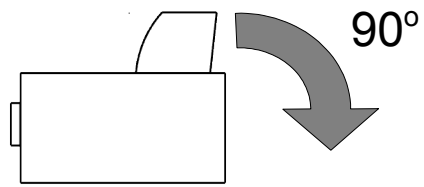

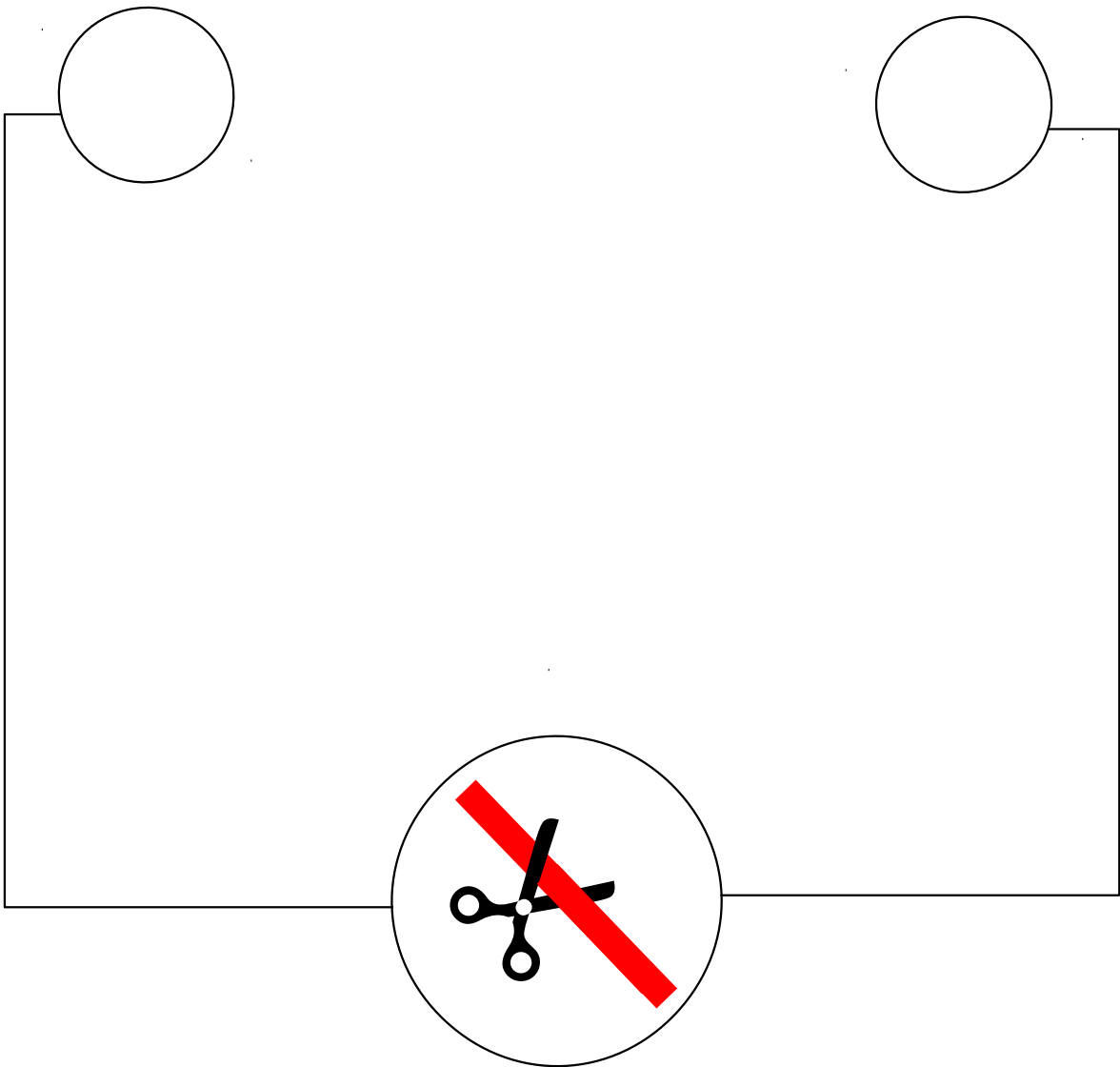
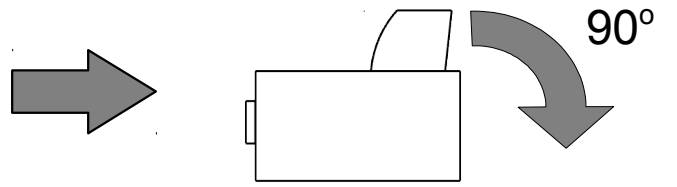

1

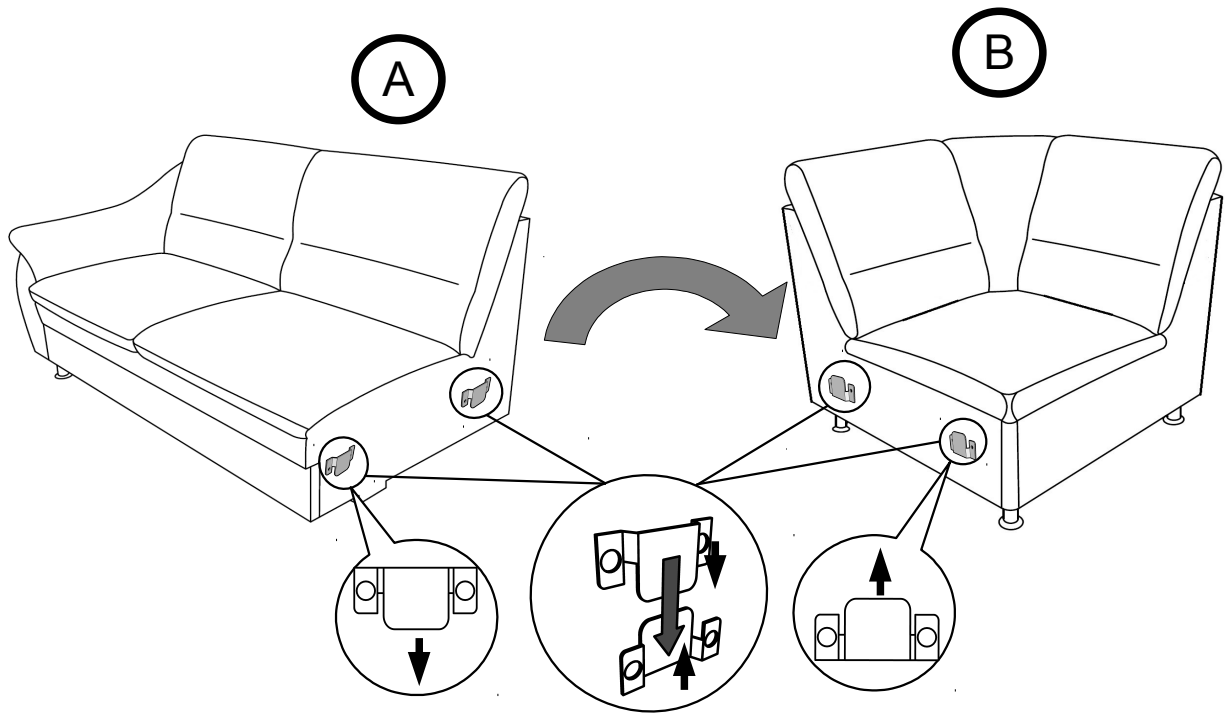

2

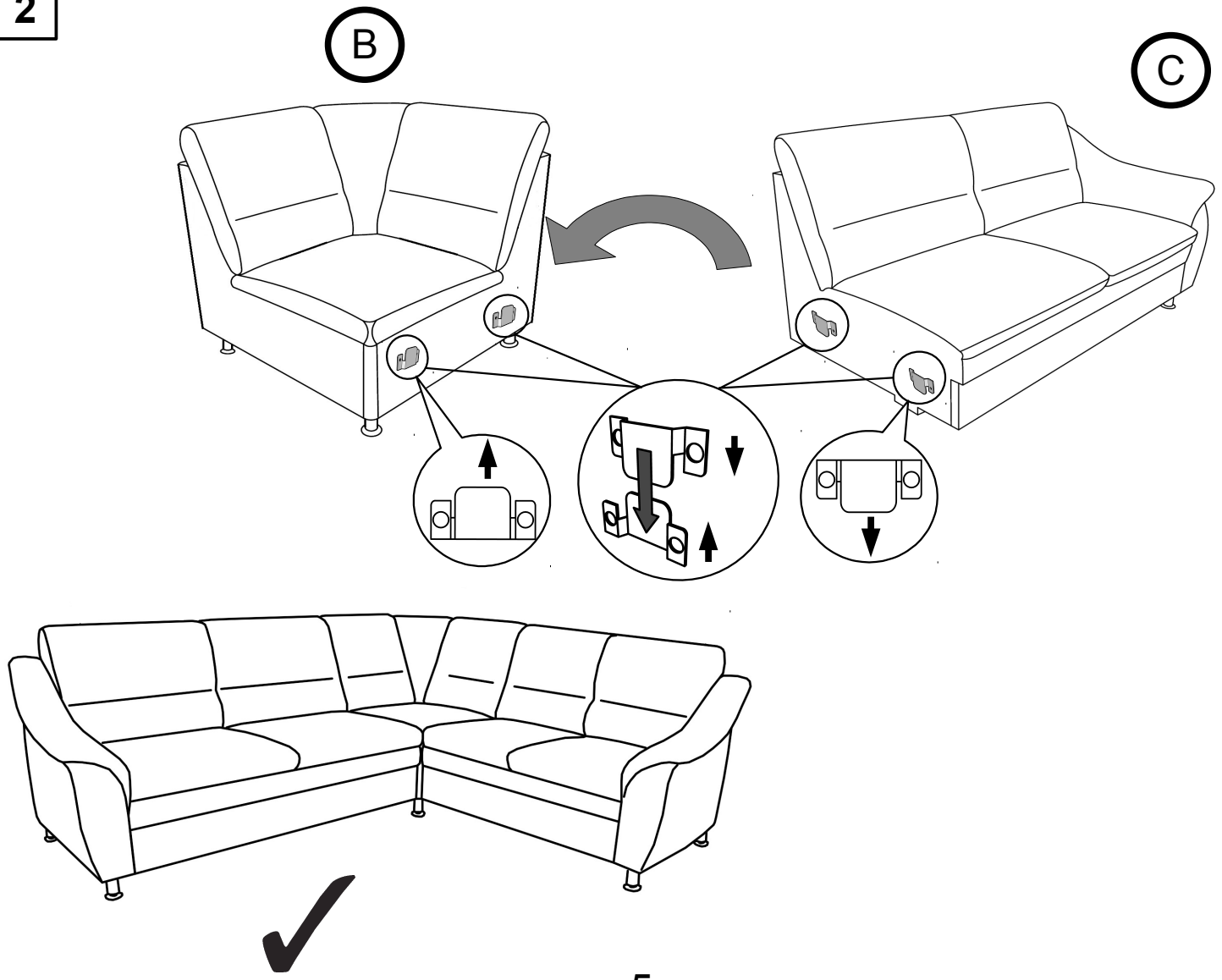

3

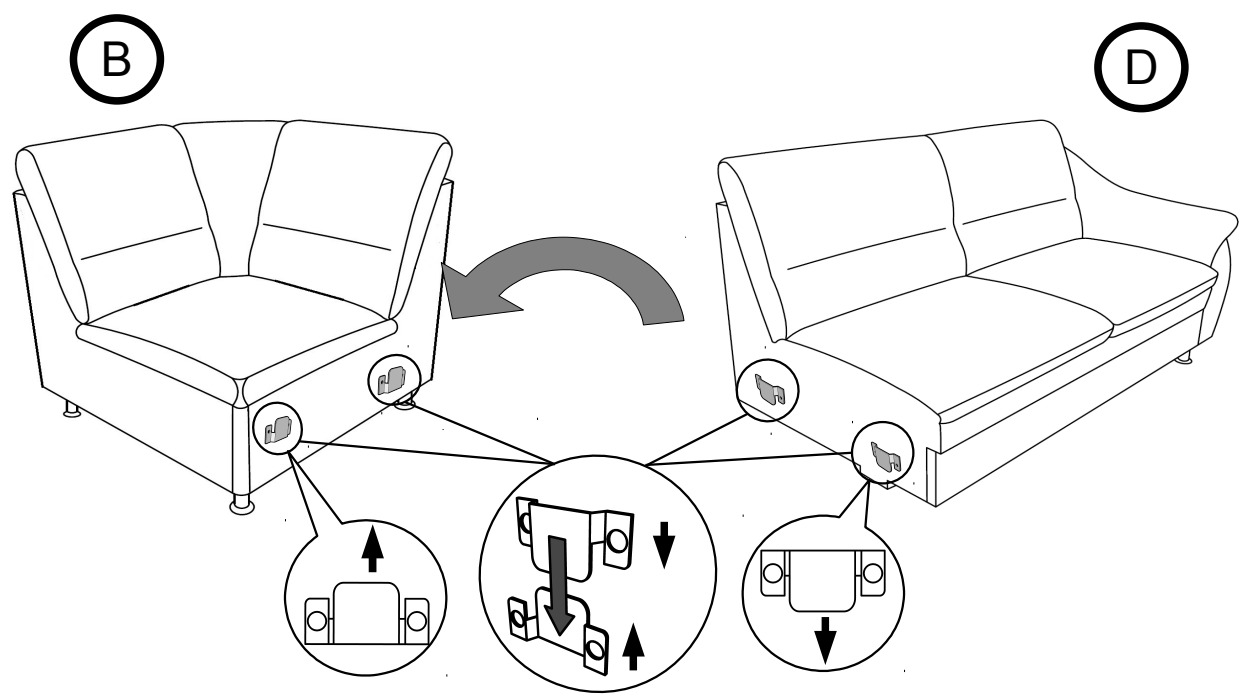

4

