

**D** Montageanleitung

**GB** Assembly instructions

**CZ** Montážní návod

**SK** Návod na montáž

**FR** Notice de montage

**IT** Istruzioni di montaggio

**HU** Szerelési útmutató

**RO** Instrucțiuni de montaj

**NL** Handleiding voor de montage

**PL** Instrukcja montażu

**TR** Montaj talimatı

**RU** Инструкция по монтажу

# CORNELIA

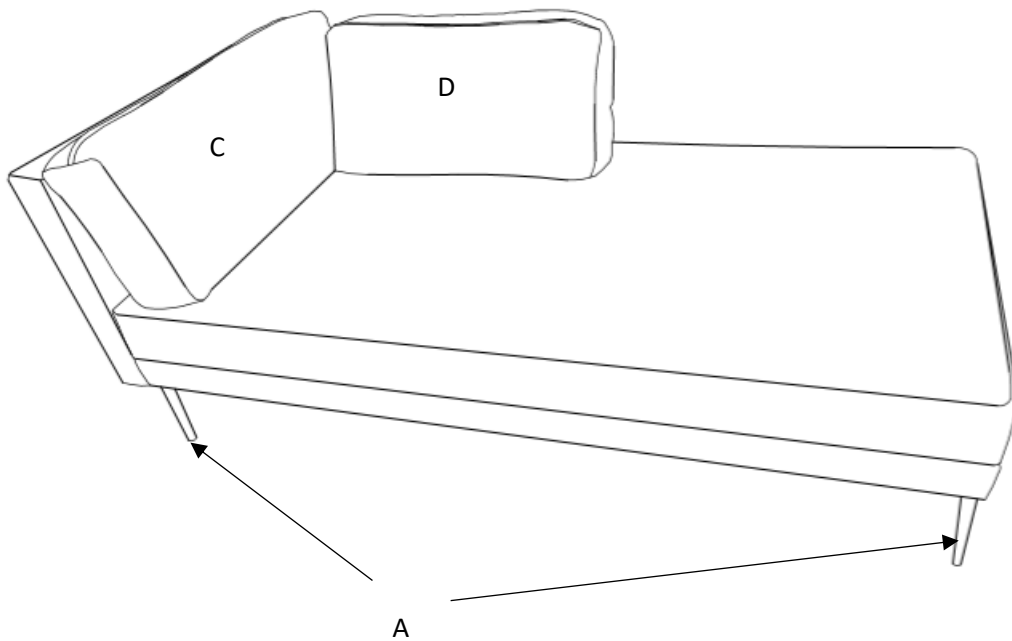

			8 Stücke M8x35 8x				
A	4x	B		C	1x	D	1x

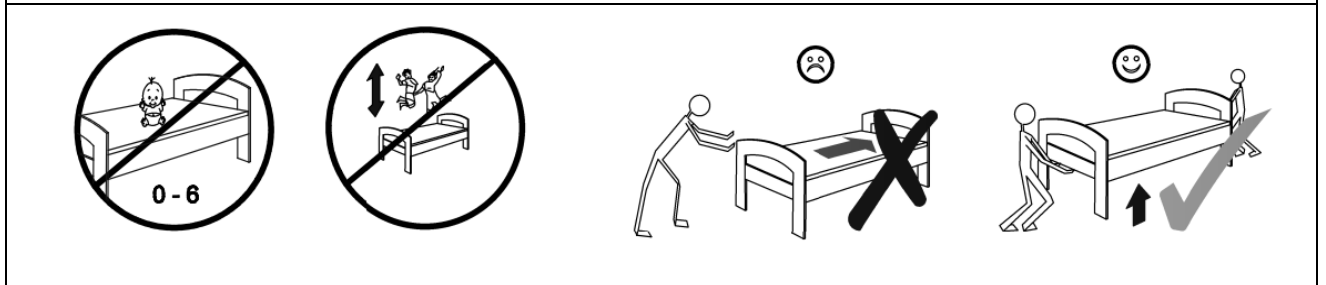
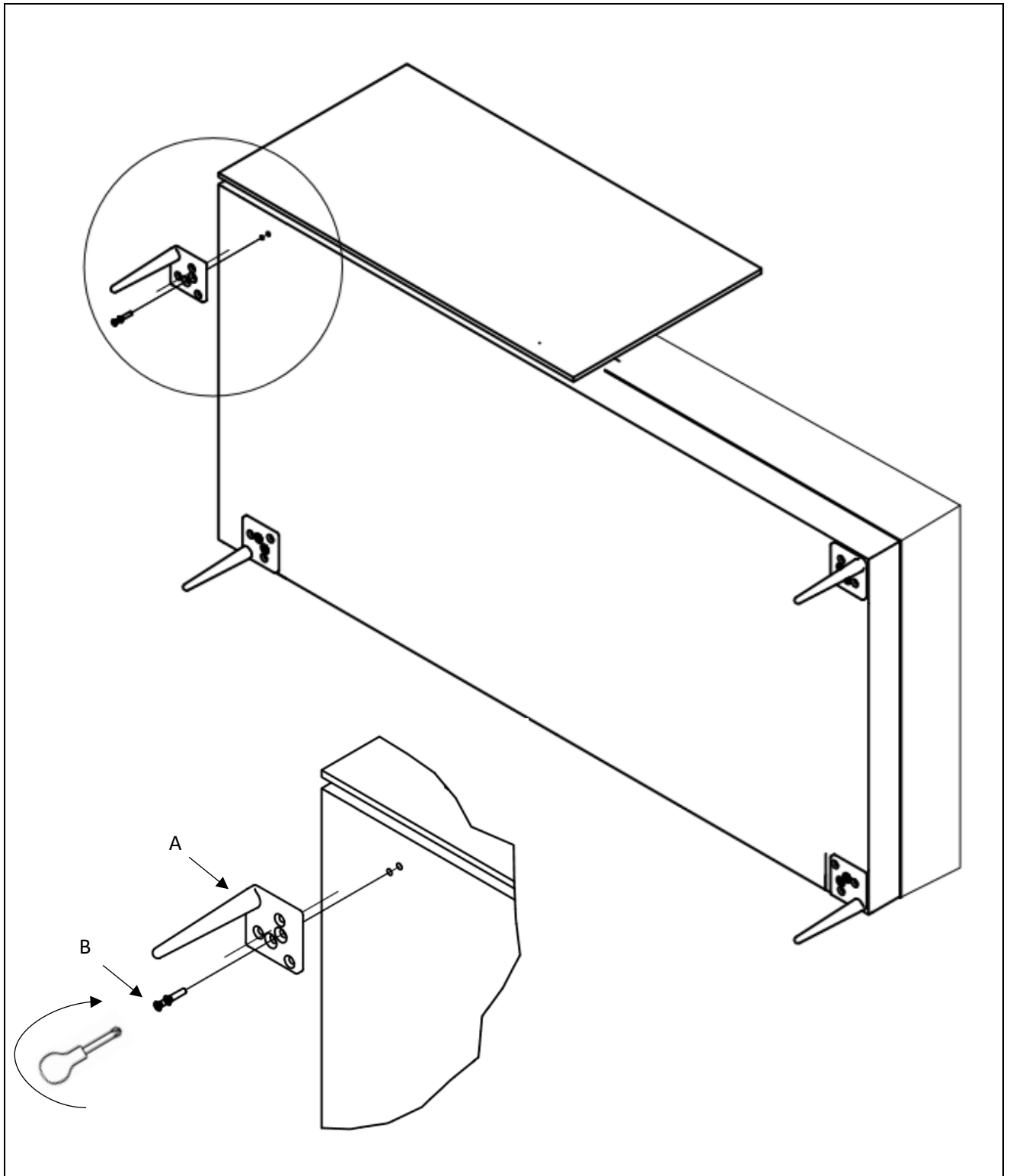

**Service • Assistenza • Dienstverlening • Serwis  
Servis • Szerviz • Сервисная служба**

Name • Naam • Nazwa • İsim • Название

**CORNELIA**

Nr. • No. • Номер

Тур • Туре • Тір • Тип

**DAYBED**

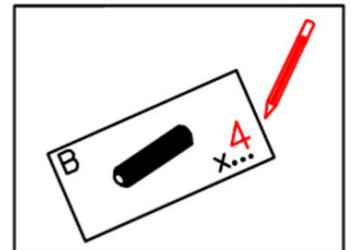
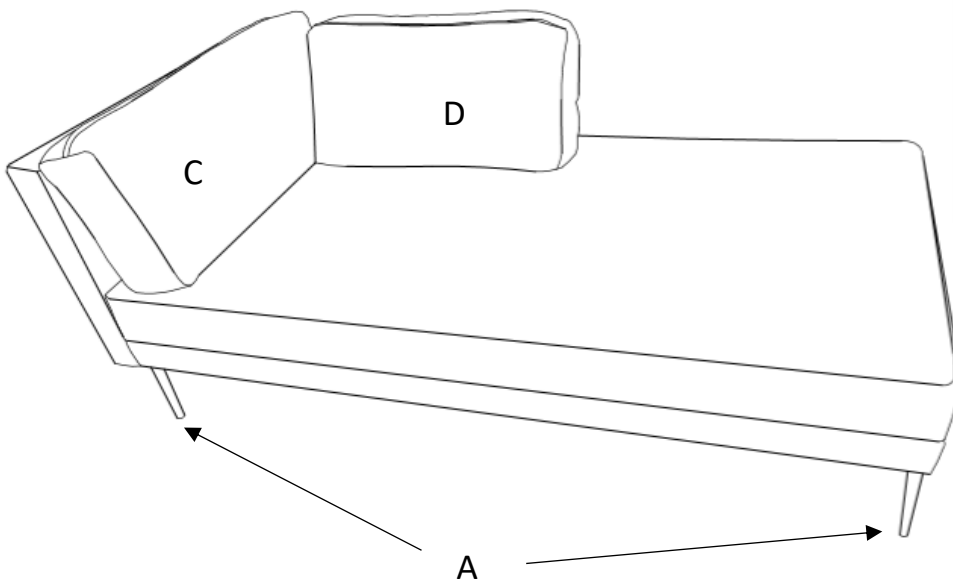
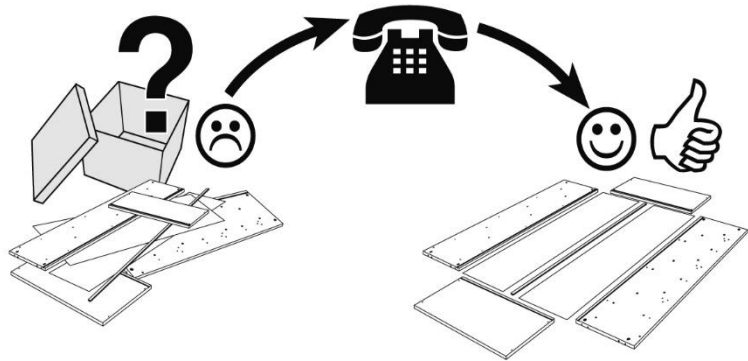
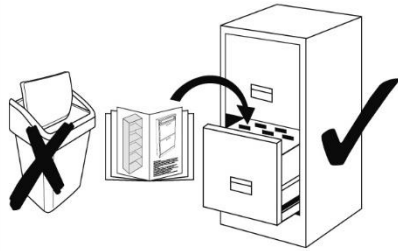

<p>A</p>	<p>B M8x35</p>	<p>C</p>	<p>D</p>