

1YYASC14/1PPASC14

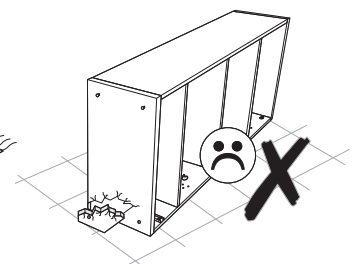

150 min

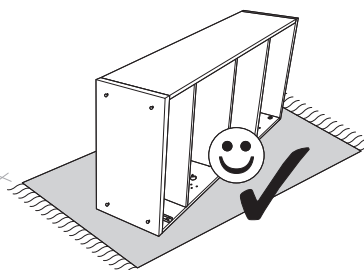

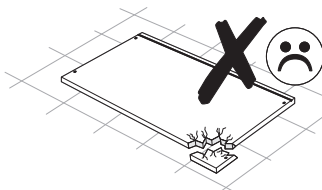
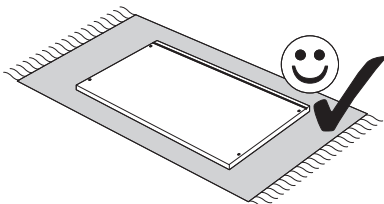
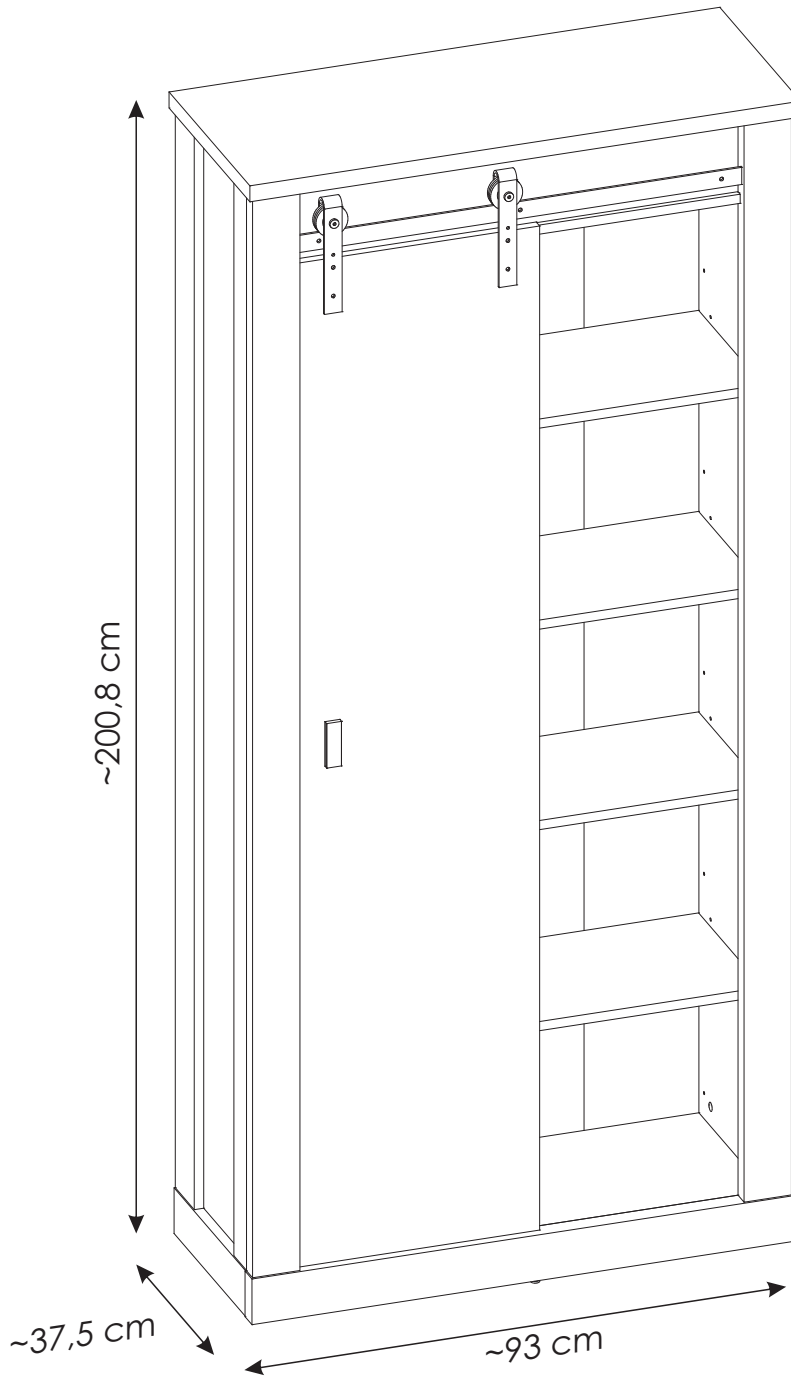
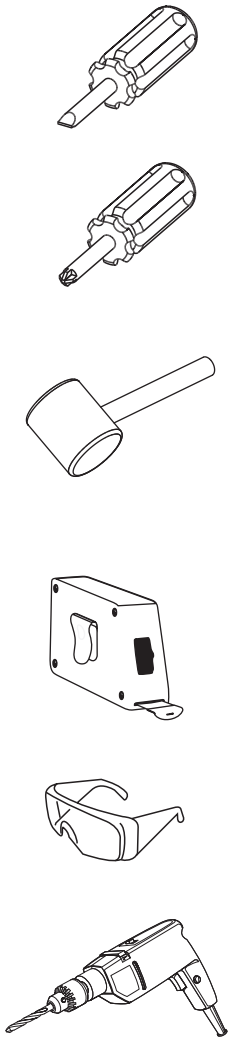
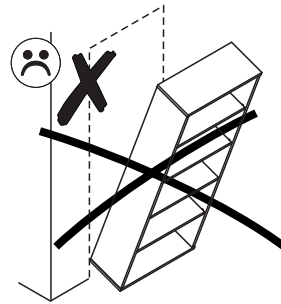
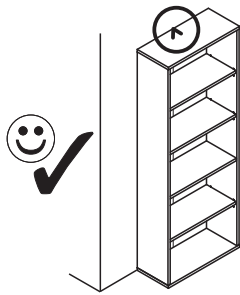

PL.

UWAGA! Mebel należy trwale zamocować do ściany, aby uniknąć ryzyka związanego z przewróceniem się mebla. W paczce nie ma śrub mocujących, ponieważ rodzaj mocowania należy odpowiednio dobrać do rodzaju ściany. Dobierz właściwe do Twojego rodzaju ściany.

D.

ACHTUNG! Um alle mit dem Umkippen des Möbels verbundenen Risiken auszuschließen, muss das Möbel fest an der Wand verankert werden. Beschläge für die Wandbefestigung sind nicht beige packt, da diese von der jeweiligen Wandbeschaffenheit abhängig sind. Bitte solche Befestigungschläge wählen, die für die heimischen Wände geeignet sind.

FR.

ATTENTION! Ce meuble doit être fixé en permanence au mur pour éviter les risques de chute. Les vis de fixation ne sont pas livrées car le type de fixation doit être choisi en fonction du type de mur. Sélectionnez les fixations adaptées au mur.

I.

ATTENZIONE! Il mobile deve essere permanentemente fissato alla parete per evitare i rischi derivanti da un ribaltamento del mobile. La confezione non include le viti di fissaggio, in quanto il tipo di fissaggio deve essere scelto in base al tipo di parete. Utilizzare viti appropriate in base al materiale della parete.

HR.

NAPOMENA! Namještaj mora biti trajno pričvršćen za zid, kako bi se izbjegao rizik od njegovog prevrtanja. U paketu nema vijaka za pričvršćivanje, jer se vrsta montaže mora prilagoditi vrsti zida. Odaberite pravu vrstu prema Vašoj vrsti zida.

EN.

WARNING! To prevent this furniture from tripping over, fix it to the wall permanently. Fixing devices are not included since different wall materials require different types of fixing devices. Please make sure you chose the correct ones for your type of wall.

SK.

POZOR! Nábytok musí byť trvalo pripevnený k stene tak, aby sa zamedzilo riziku prevrátenia. Balík neobsahuje upevňovacie skrutky, pretože typ upevnenia je treba vybrať podľa typu steny. Vyberte typ vhodný pre Vašu stenu.

CZ.

POZOR! Nábytek je nutné pevně připevniť ke zdi, abychom se vyhnuli riziku spojenému s jeho převrnutím. Součástí balení nejsou připevňovací šrouby, protože způsoby připevnění je nutné zvolit podle druhu stěny. Vyberte správný pro Váš typ stěny.

RU.

ПРИМЕЧАНИЕ! Эту мебель необходимо всегда прикреплять к стене, чтобы избежать рисков, связанных с переворотом мебели. В пакете нет крепежных винтов, потому что тип крепления должен быть выбран в соответствии с типом стены. Выберите, пожалуйста, правильные винты к вашей стене.

RO.

ATENȚIE! Mobila trebuie ancorată permanent în perete pentru a evita riscul de răsturnare a mobilei. În pachet nu sunt incluse șuruburile de fixare, deoarece tipul de ancoraj trebuie ales în funcție de tipul de perete. Alegeți șuruburile potrivite pentru tipul Dvs. de perete.

TR.

DİKKAT! Devrilme riskini önlemek için mobilya duvara sabitlenmelidir. Sabitleme civataları pakete dahil değil, çünkü sabitleme tertibatının tipi, duvara tipine uygun olarak seçilmelidir. Onu duvarınızın tipine göre seçiniz.

AR.

ملاحظة!

يجب تثبيت الأثاث بإحكام إلى الحائط أو الجدار لتجنب خطر إنقلابه. لا تحتوي العلبة على مسامير التثبيت، إذ إنه ينبغي إستعمال المسامير المخصصة لنوعية الحائط أو الجدار. اختر المسامير التي تناسب جدارك.

E.

¡ATENCIÓN! El mueble debe ser fijado permanentemente a la pared para evitar el riesgo relacionado con el vuelco del mueble. En el paquete no hay tornillos de fijación, ya que se debe elegir el tipo de fijación adecuado para el tipo de pared. Elija el apropiado para su tipo de pared.

CN.

注意！本家具需要固定在墙上以免倒塌。箱子里没有安装螺钉。因为安装方式需要根据墙的类型调整。请按照您的墙类型选择合适的安装方式。

SLO.

POZOR! Pohištvo trajno pritrdite na steno, da preprečite tveganje, da se prevrne. V paketu ni pritrdilnih vijakov, saj je treba način pritrditve ustrezno izbrati glede na vrsto stene. Izberite način, ki je ustrezen za vašo steno.

HU.

FIGYELEM! Rögzítse a bútorokat a falhoz, hogy elkerülje a bútor felborulásának kockázatát. A készletben nem találhatóék rögzítőcsavarok, mivel a rögzítés típusa a fal típusától függ. Válassza ki a fal típusának megfelelő kötőelemeket.





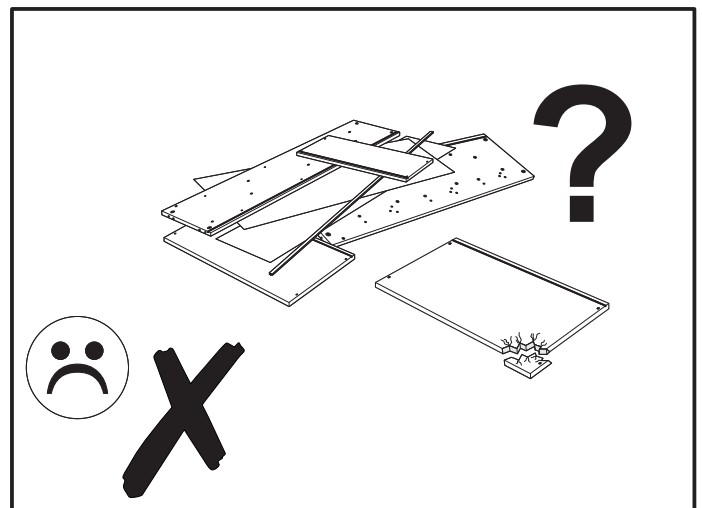
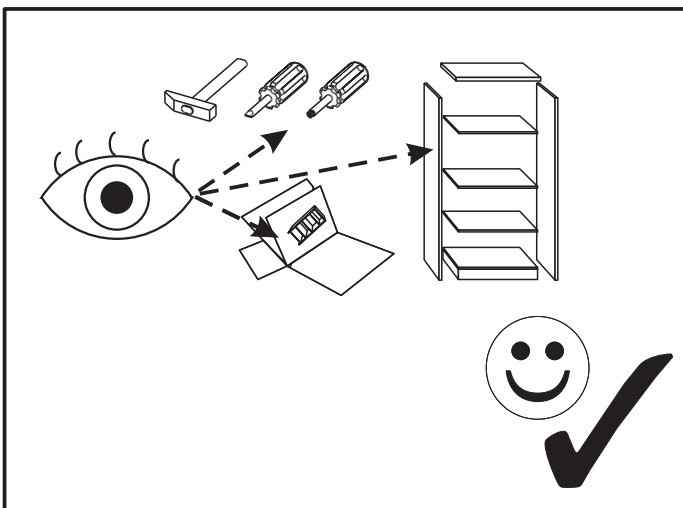
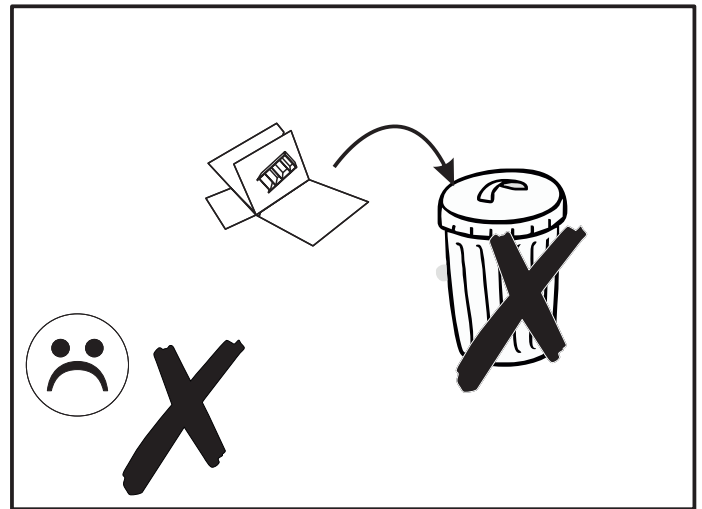
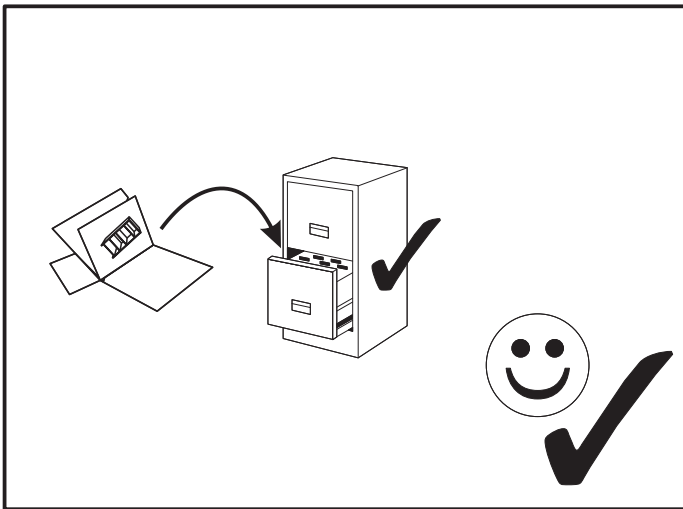
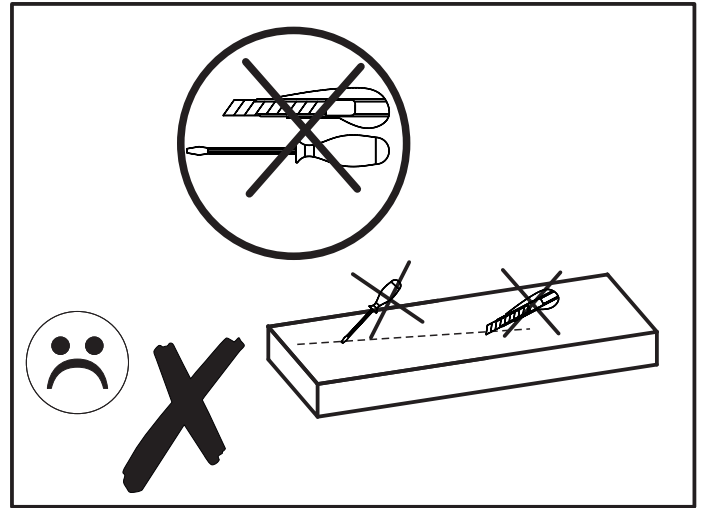
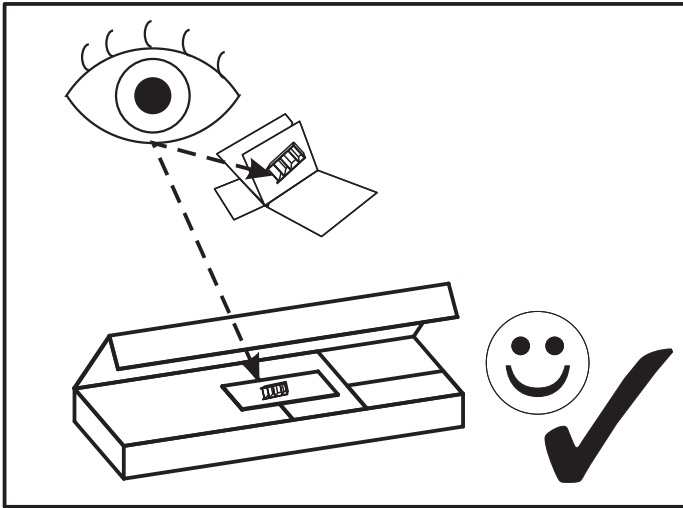



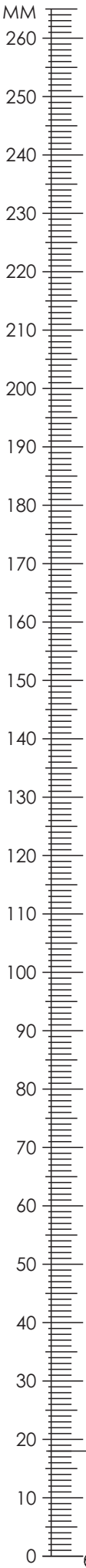



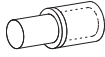

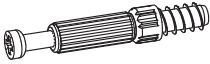

NL.

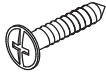
OPMERKING! De meubelen moeten permanent aan de muur worden bevestigd om te voorkomen dat de meubelen kantelen. Er zitten geen bevestigingsschroeven in het pakket, omdat het type bevestiging moet worden gekozen op basis van het type muur. Kies de juiste voor uw type muur.

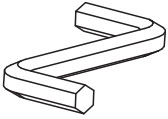
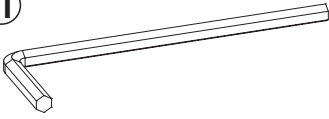

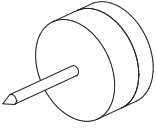
1YYASC14/1PPASC14

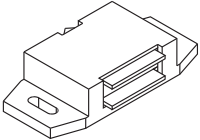
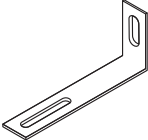
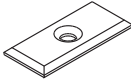
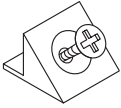
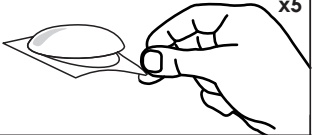

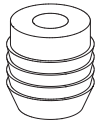
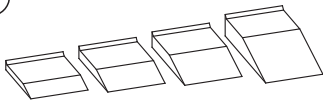
A0	8 x 20 mm	x16	A1	8 x 35 mm	x60	D2		x32
								
E0	Ø16	x18	E1	15 x 12 mm	x46	F1	6 x 34 mm	x46
								
G1	7 x 50 mm	x2	H2	L - 78 mm	x1	I0	3 x 13 mm	x2
								
I2	4 x 16 mm	x2	I4	4 x 27 mm	x4	K4	M4 x 35 mm	x2
								
M		x1	M1		x1	N1	3 x 16 mm	x25
								
N14	4 x 30 mm	x24	O2		x7	P16		x20
								
Q1		x1	Q9		x2	R1		x11
								
R4		x8	R8		x5	R10		x1
								
S17		x4	Z		x1			
								

1YYASC14/1PPASC14

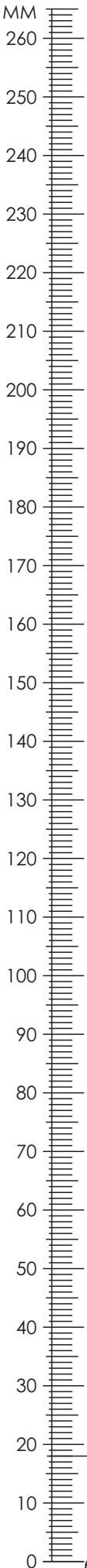

BE SC 07 48 00

x1

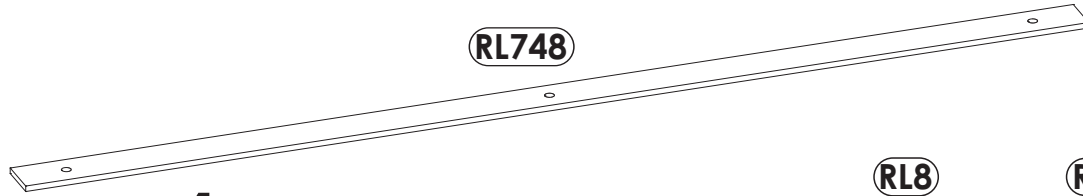

x1

RL748



x3



x3



x4

RL1



x2

RL3



x2

RL2

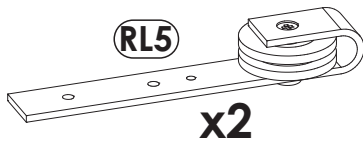

x2

RL5



x2

RL6



x1

RL7

1YYASC14/1PPASC14

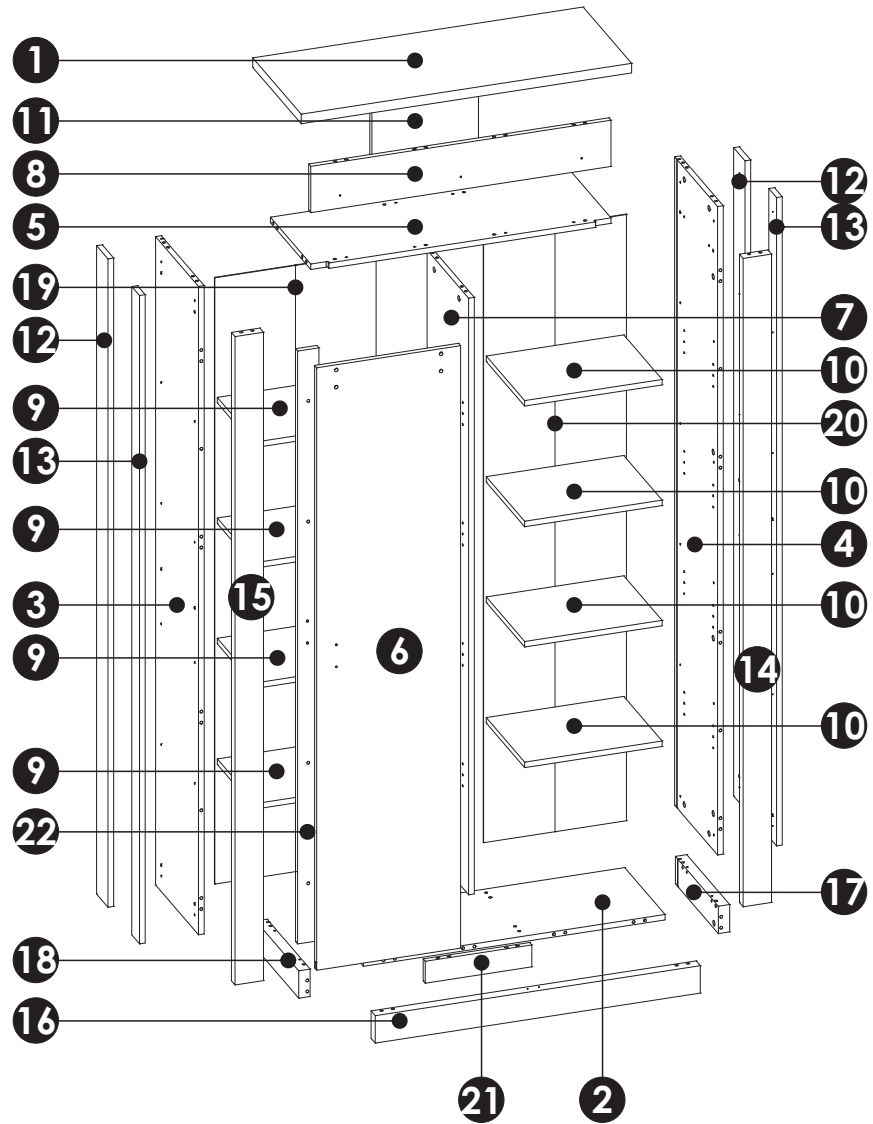
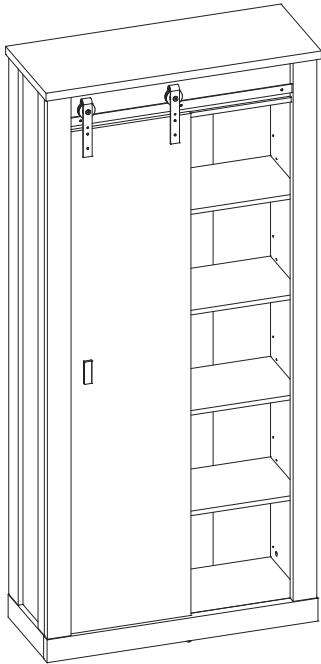

1	930	375	28	x1	2/3
2	849	312	16	x1	1/3
3	1892	332	16	x1	3/3
4	1892	332	16	x1	3/3
5	845	320	16	x1	1/3
6	1758	405	16	x1	2/3
7	1741	316	16	x1	2/3

8	845	135	16	x1	2/3
9	440	292	16	x4	1/3
10	387	292	16	x4	1/3
11	300	135	16	x1	2/3
12	1892	88	16	x2	3/3
13	1892	60	16	x2	3/3
14	1892	80	28	x1	3/3

15	1892	80	28	x1	3/3
16	915	80	32	x1	3/3
17	332	80	32	x1	3/3
18	332	80	32	x1	3/3
19	1769	454	3	x1	2/3
20	1769	402	3	x1	2/3
21	300	64	16	x1	2/3
22	1680	60	16	x1	2/3



1 ▶

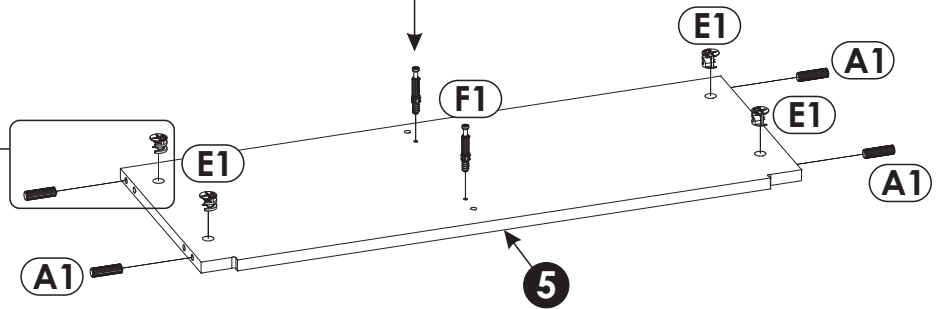
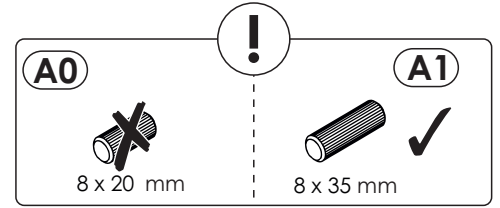
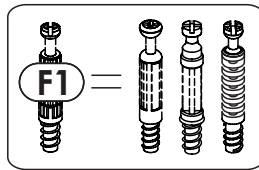
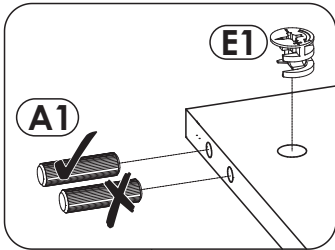
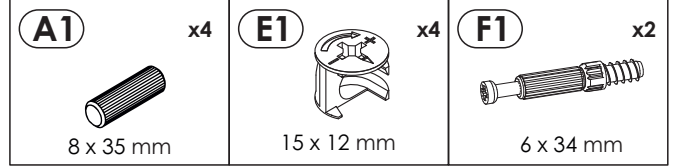
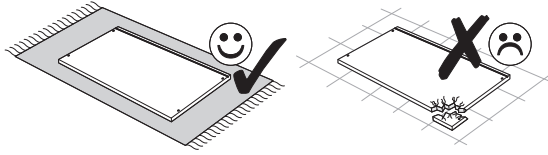

2 ▶

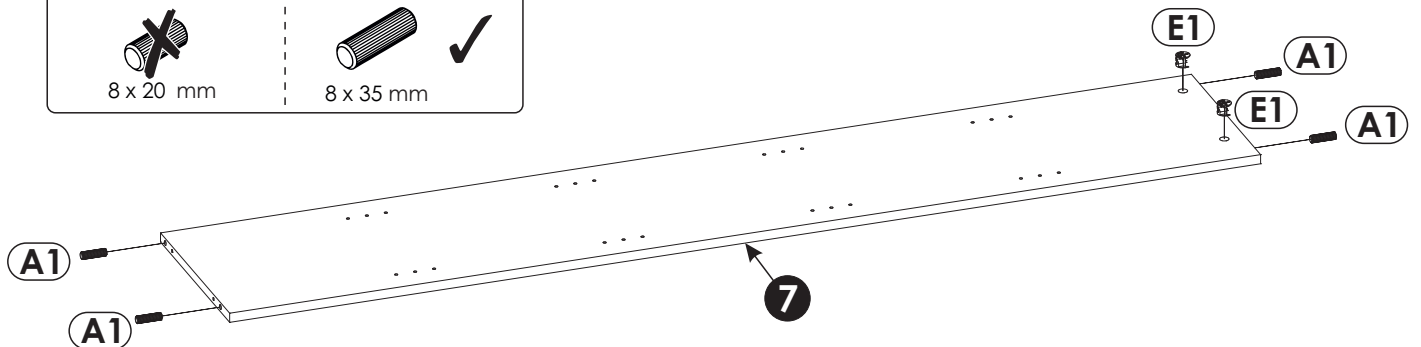
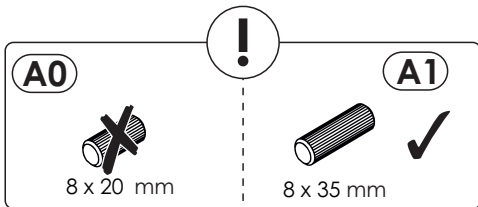
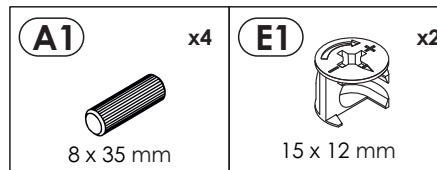
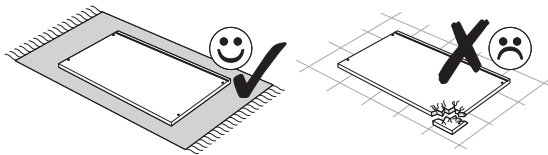

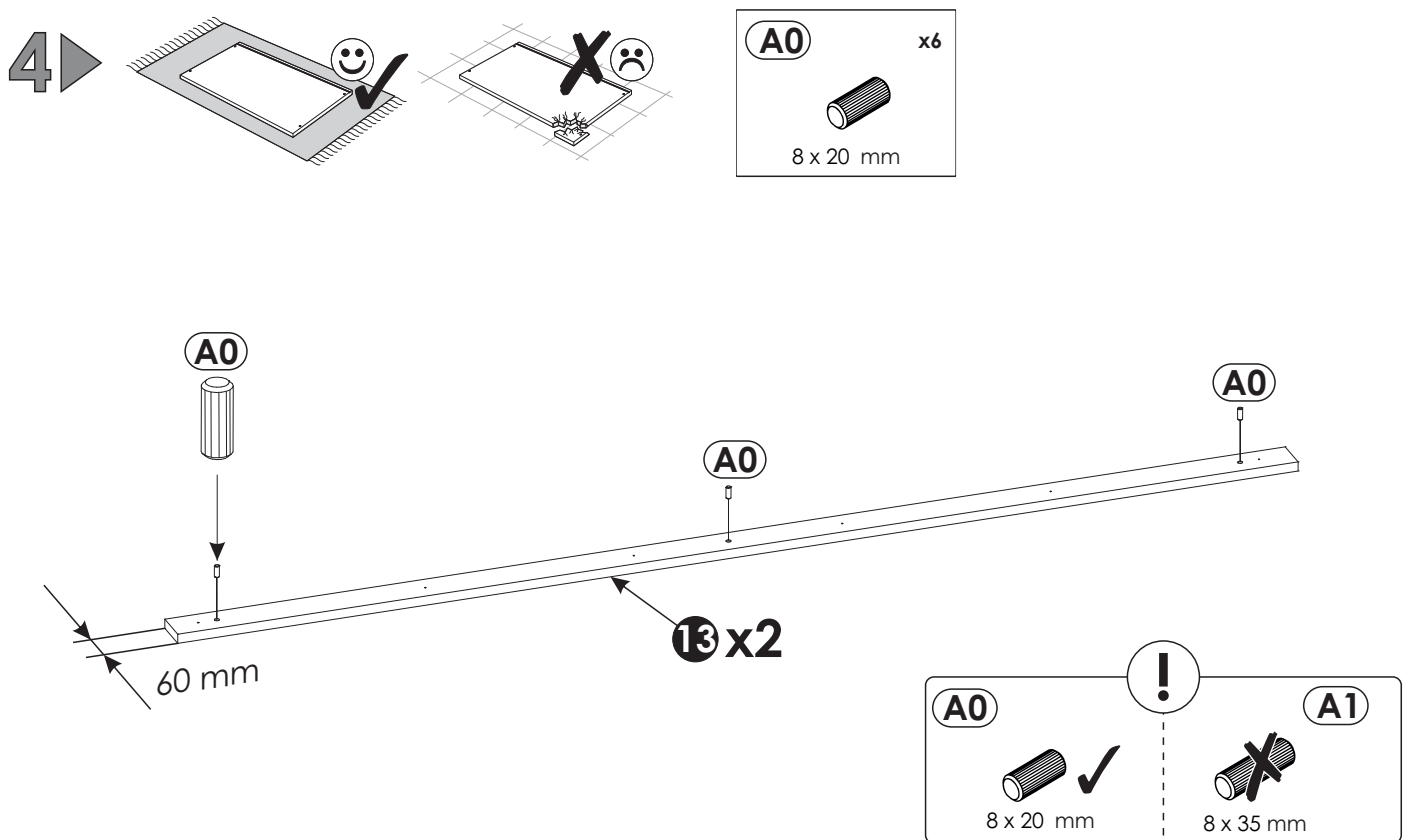
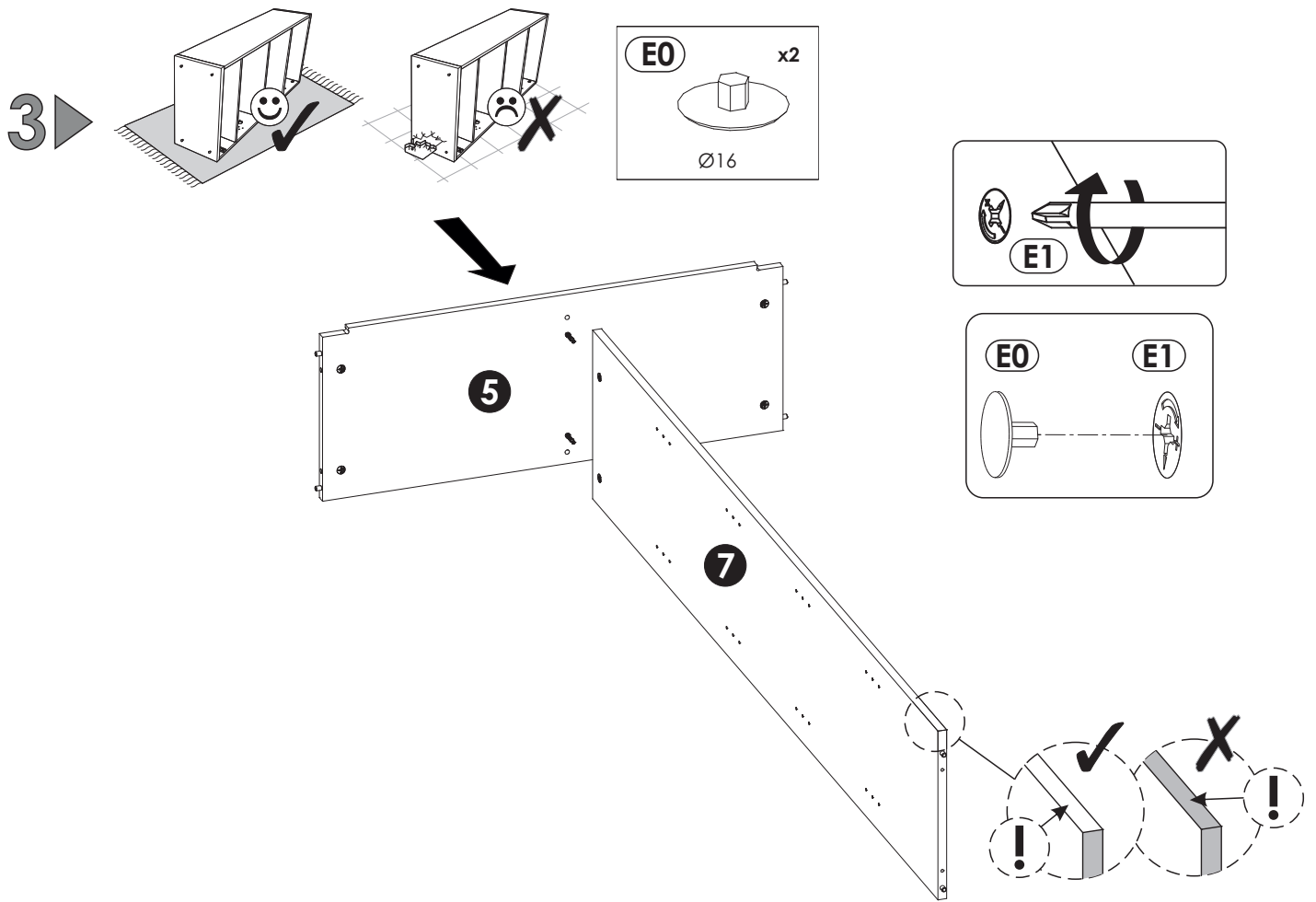

5 ▶

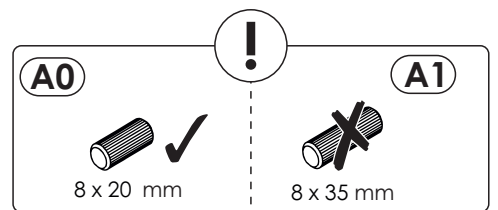
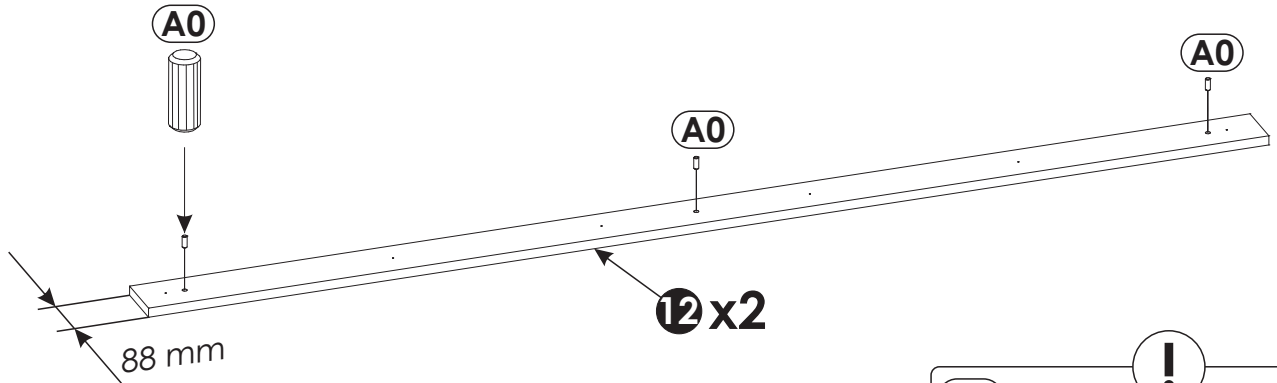
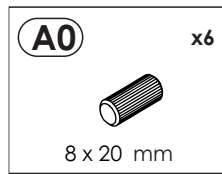
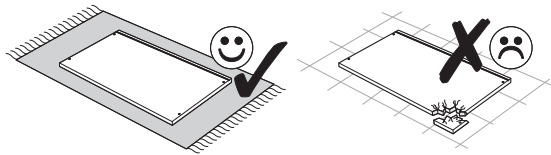

6 ▶

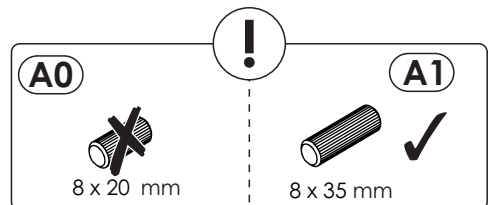
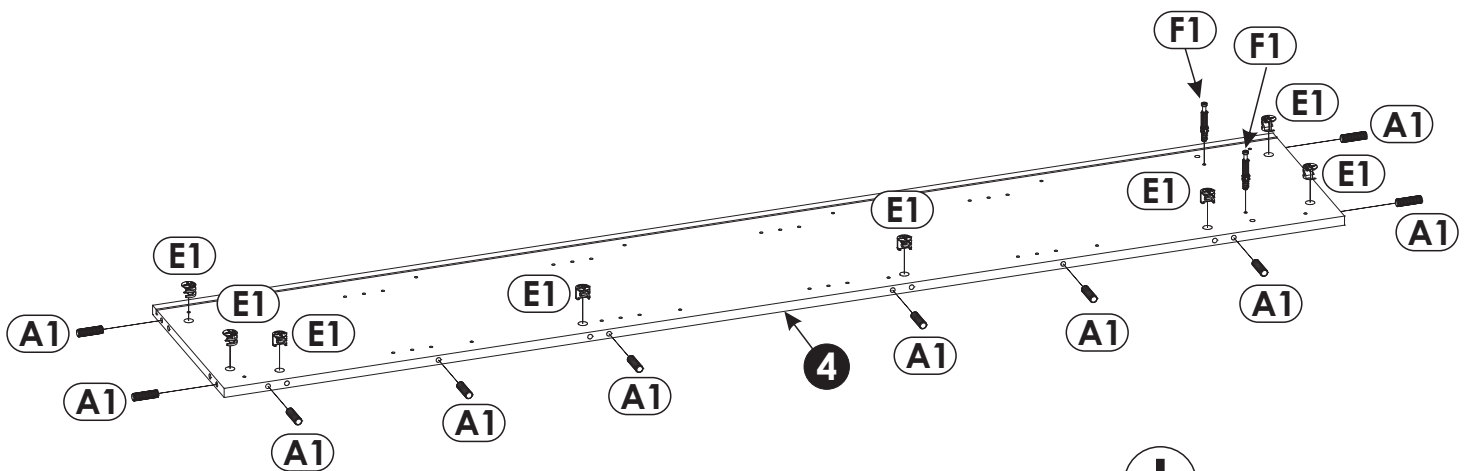
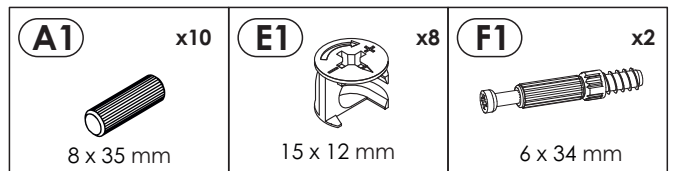
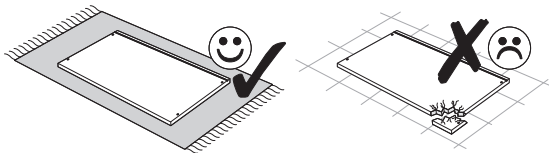

7 ▶

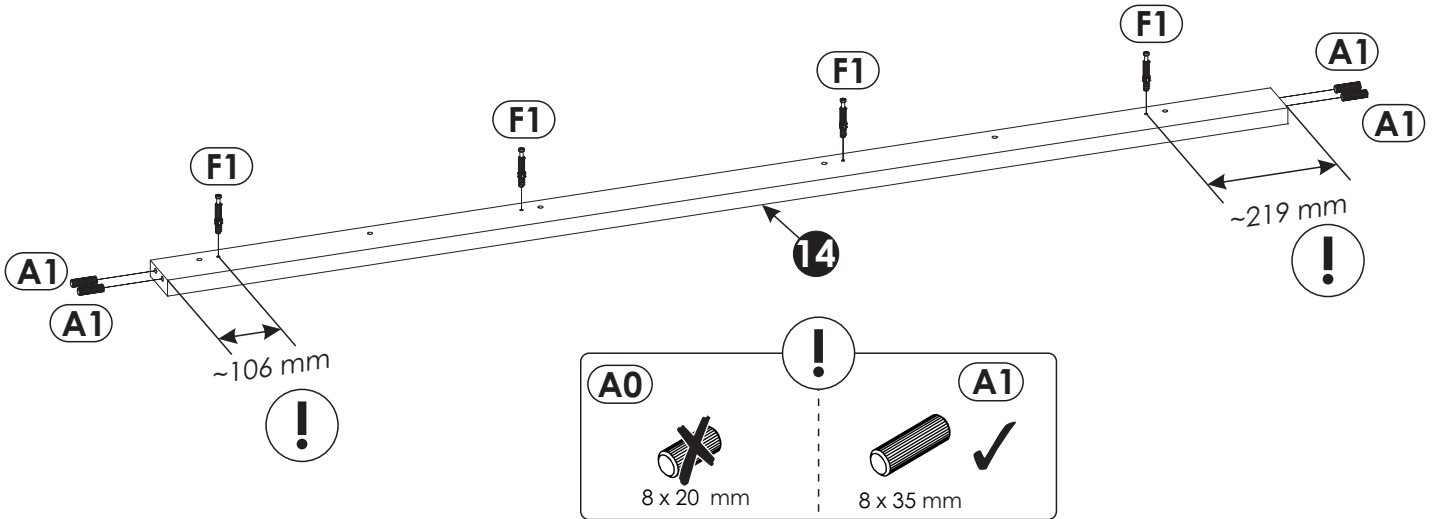
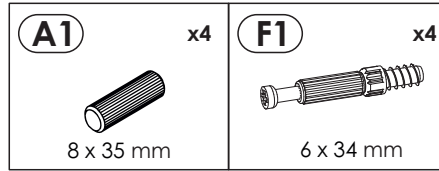
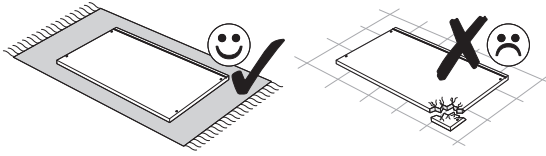

8 ▶

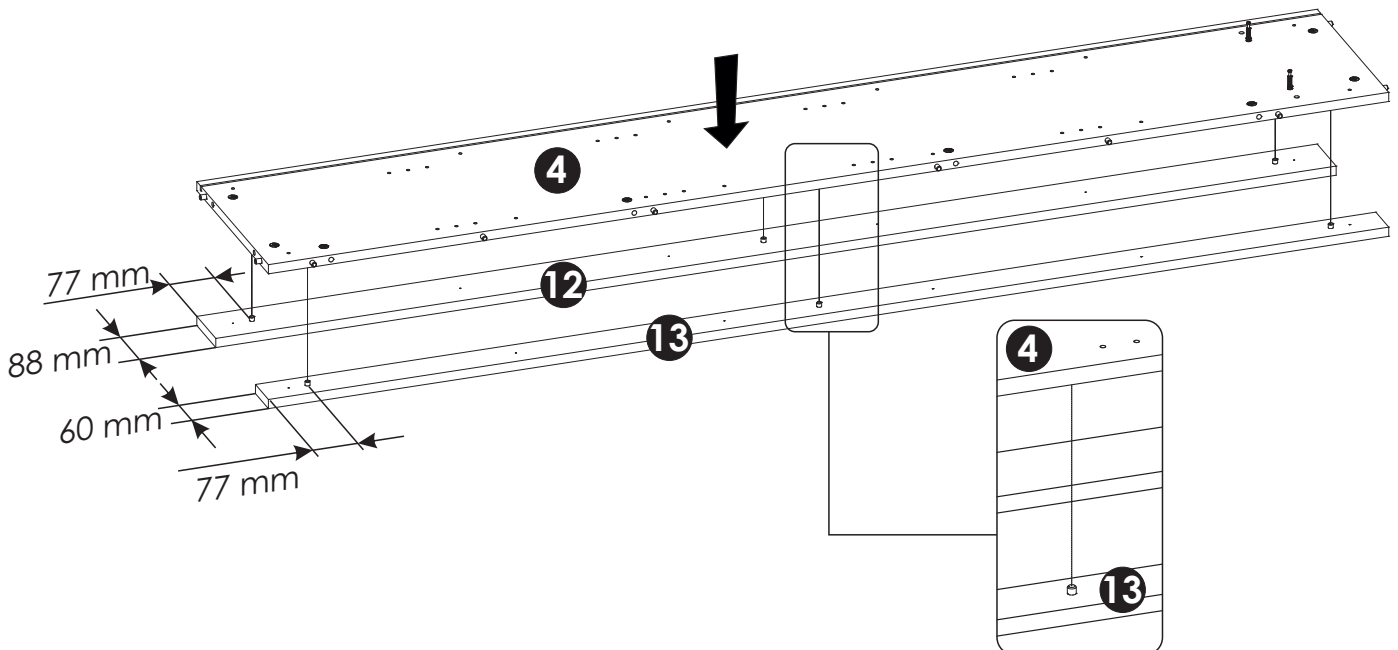
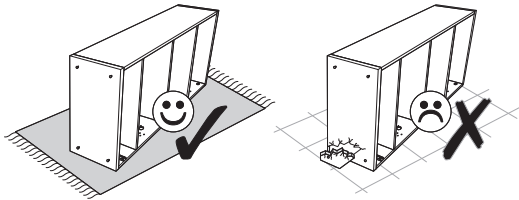

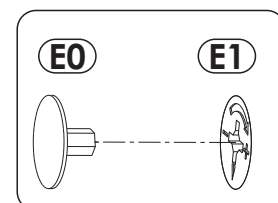
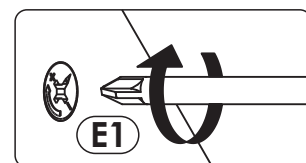
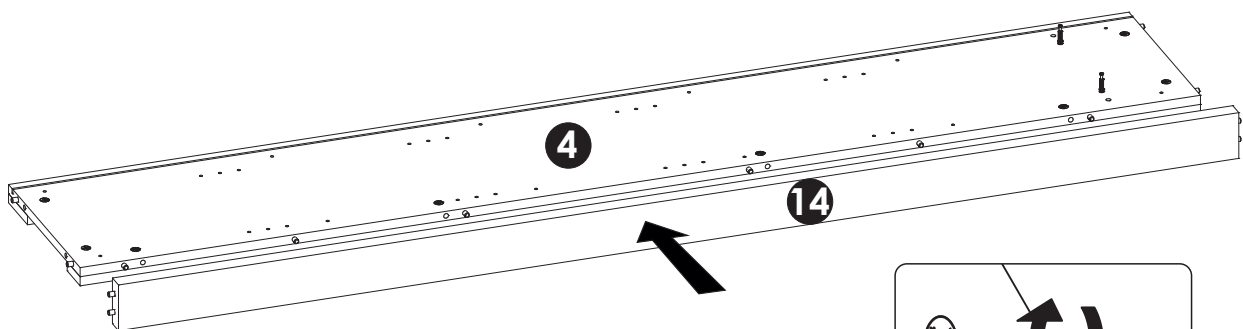
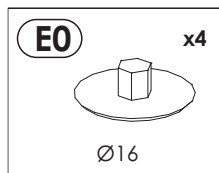
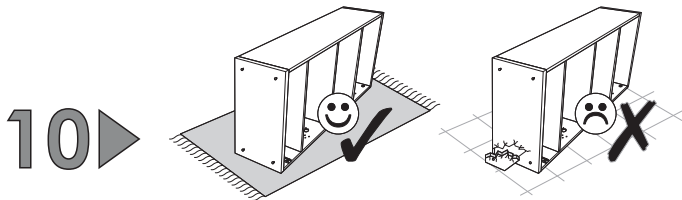
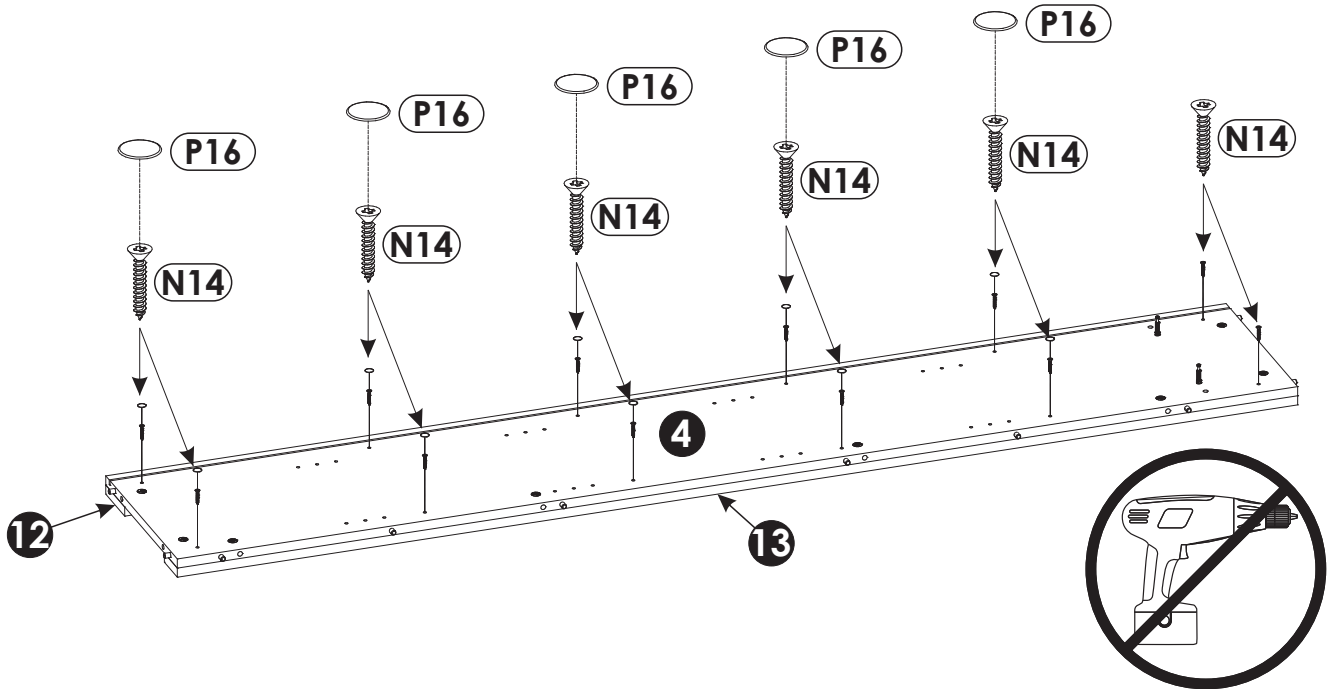
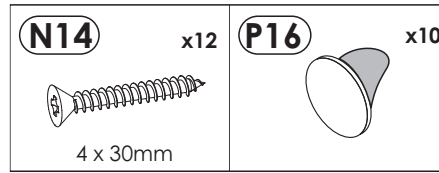
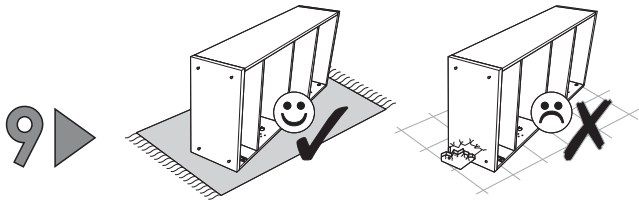

13▶

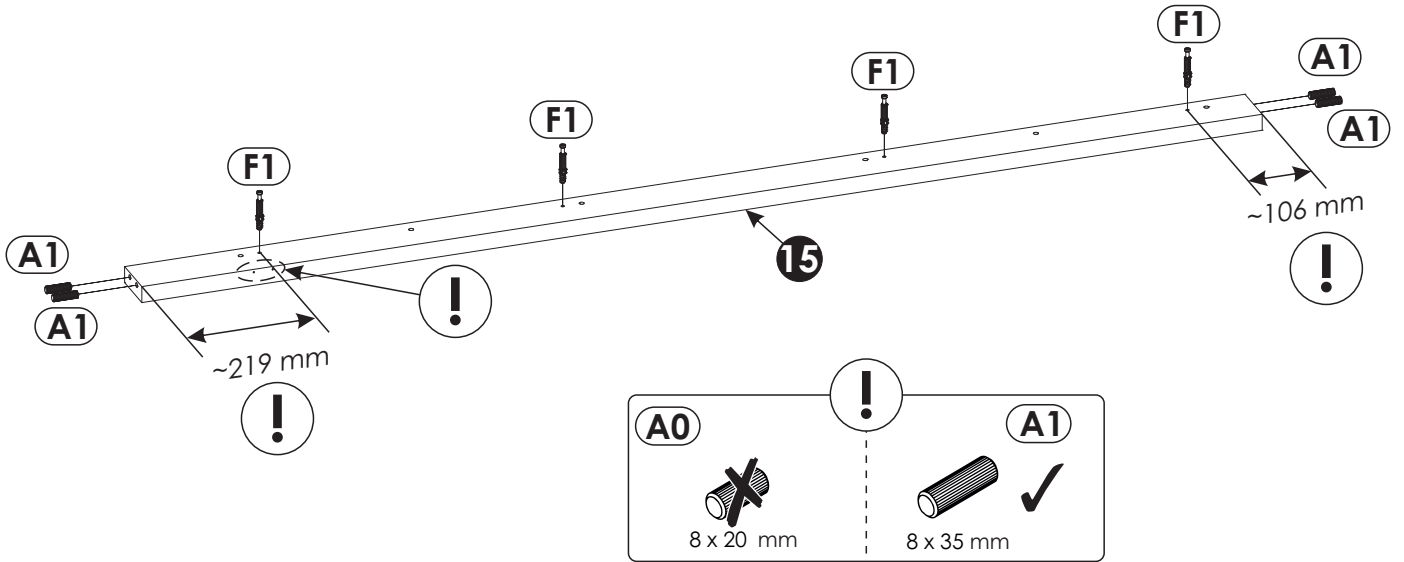
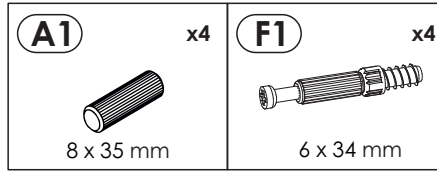
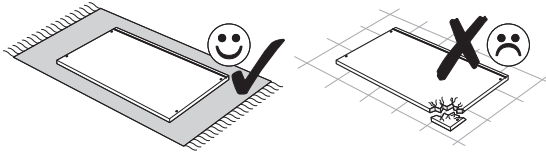

14▶

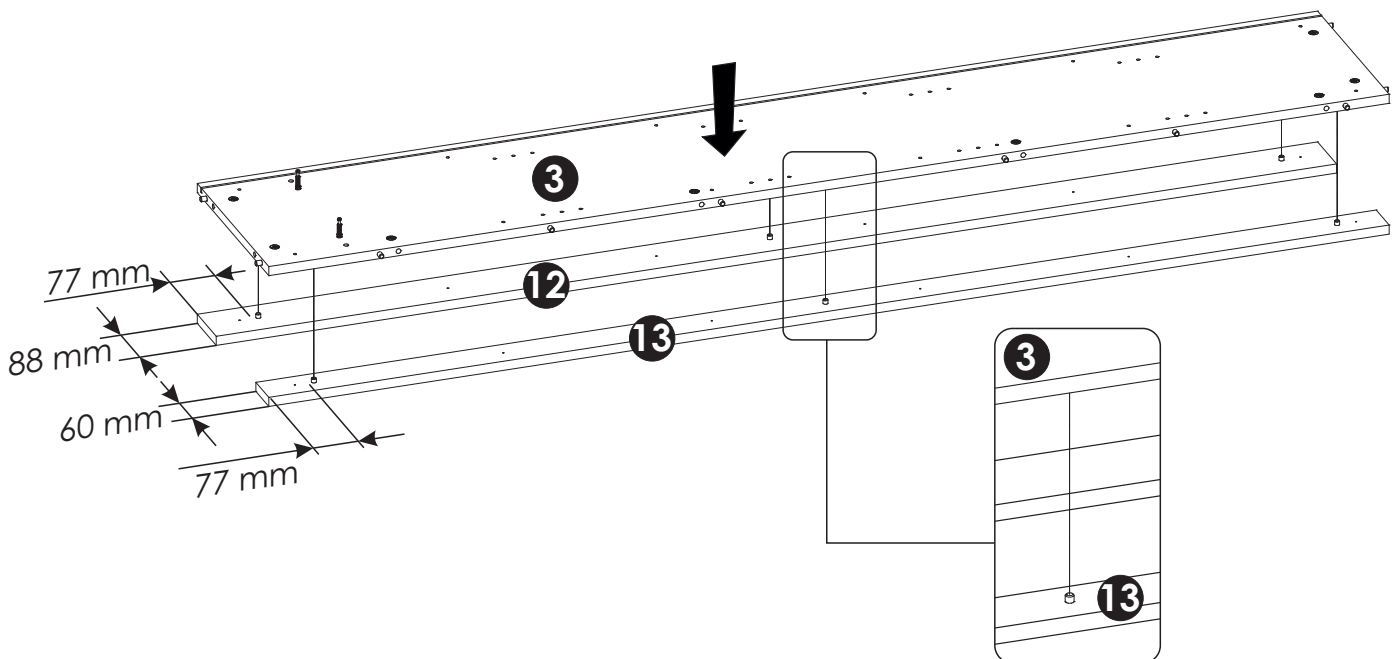
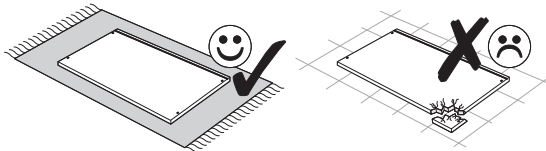

15▶

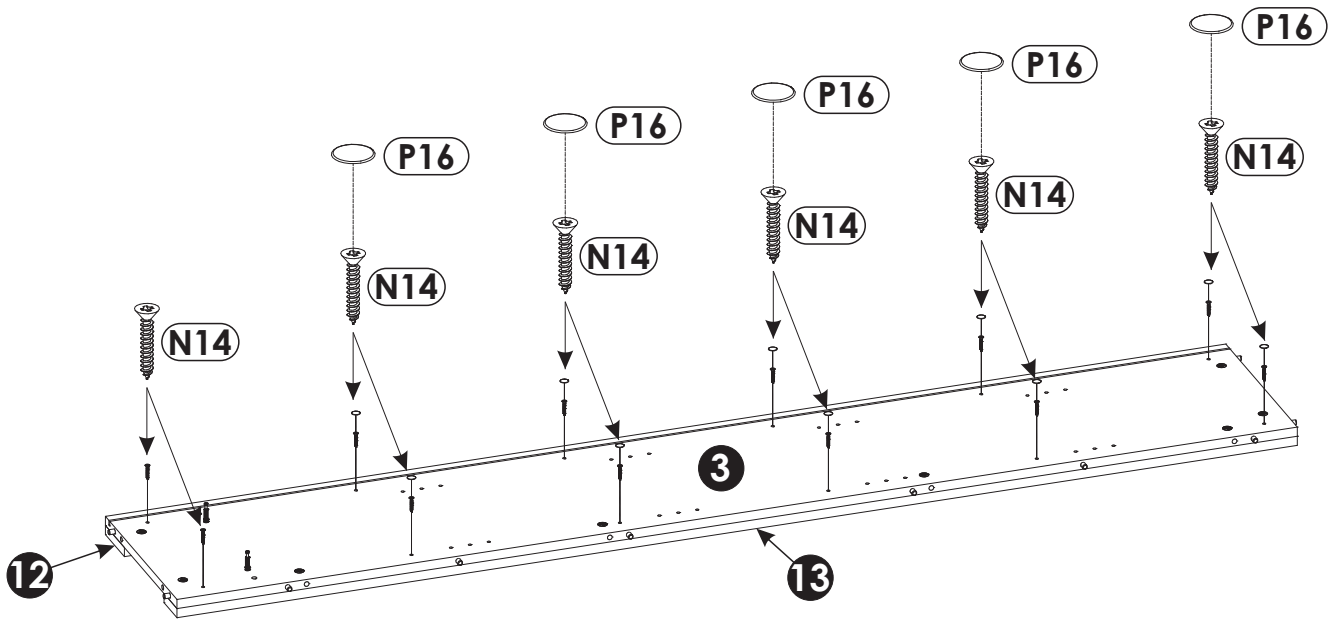
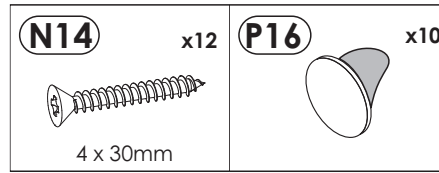
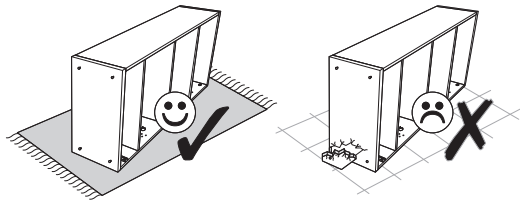

16▶

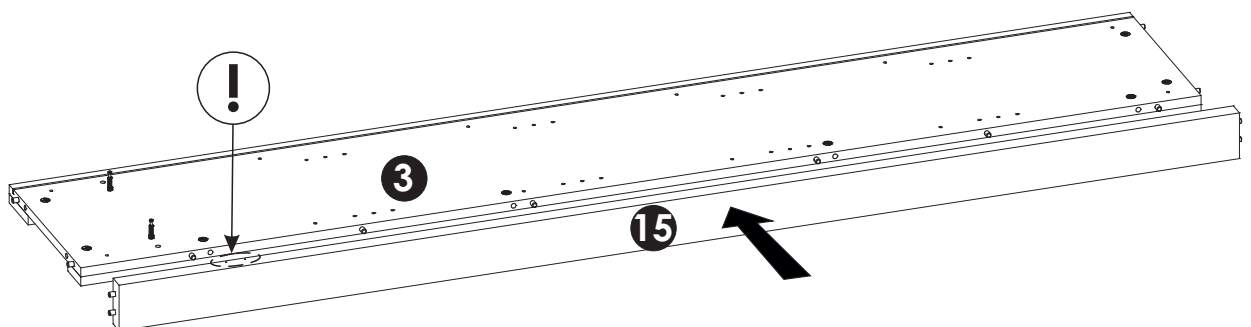
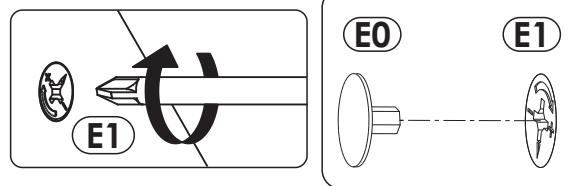
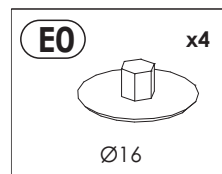
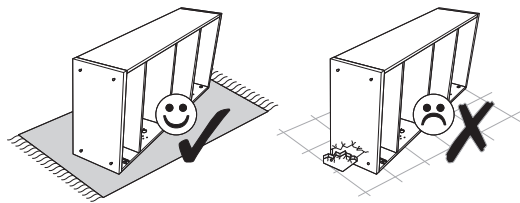

17 ▶

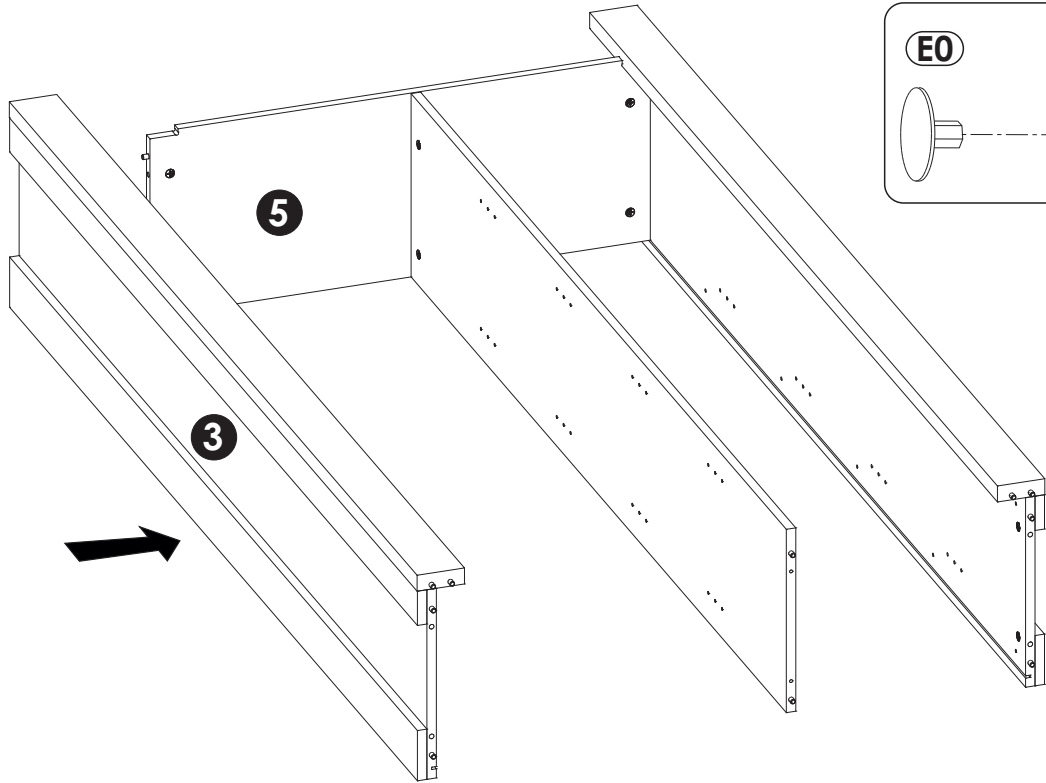
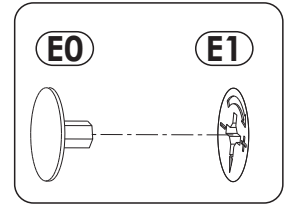
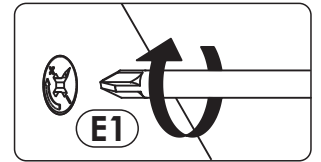
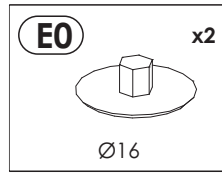
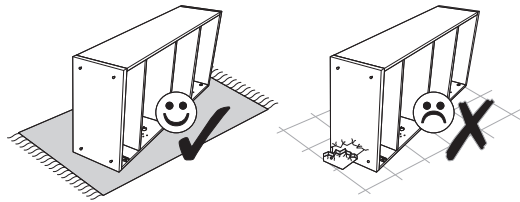

18 ▶

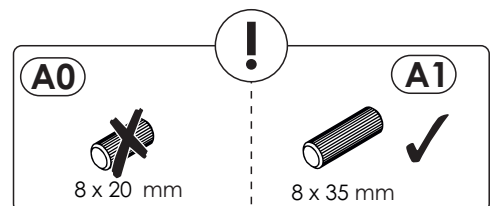
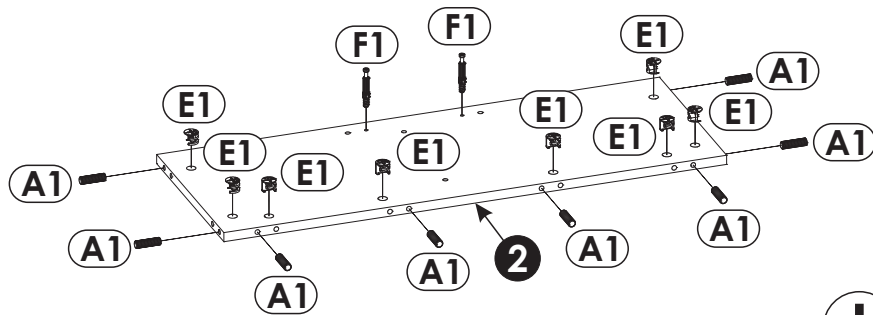
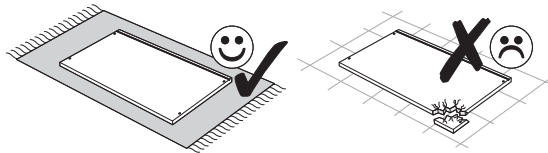

19 ▶

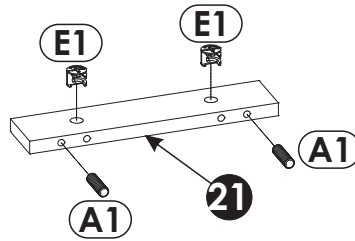
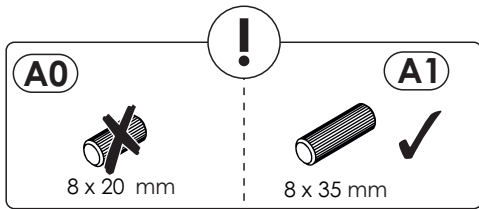
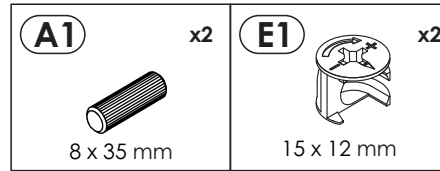
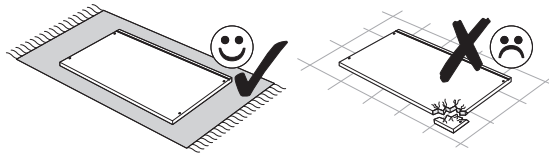

20 ▶

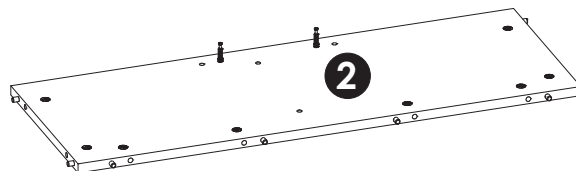
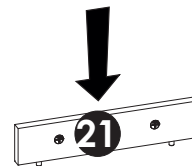
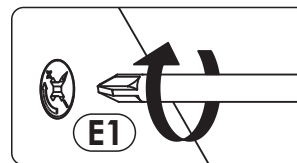
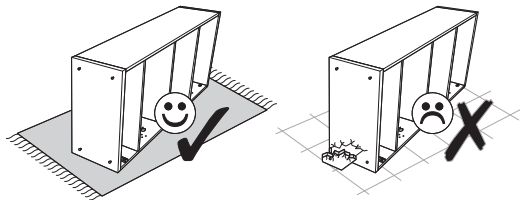

21 ▶

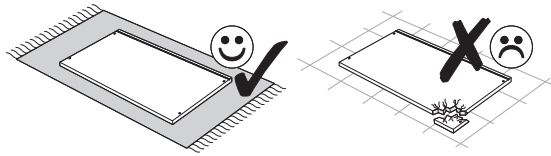

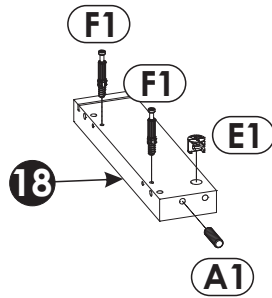
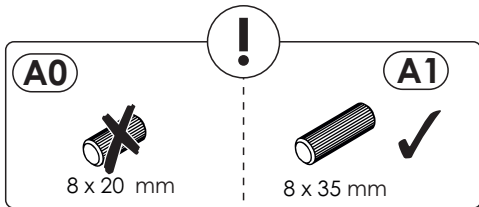

A1	x1	E1	x1	F1	x2
					
8 x 35 mm		15 x 12 mm		6 x 34 mm	

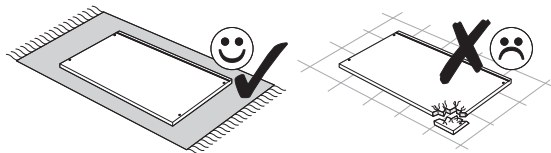

22 ▶

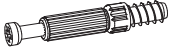

A1	x1	E1	x1	F1	x2
					
8 x 35 mm		15 x 12 mm		6 x 34 mm	

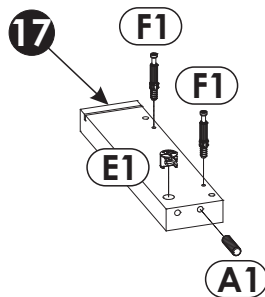
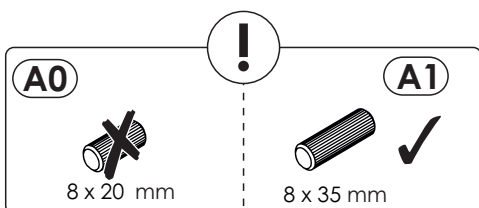

23 ▶

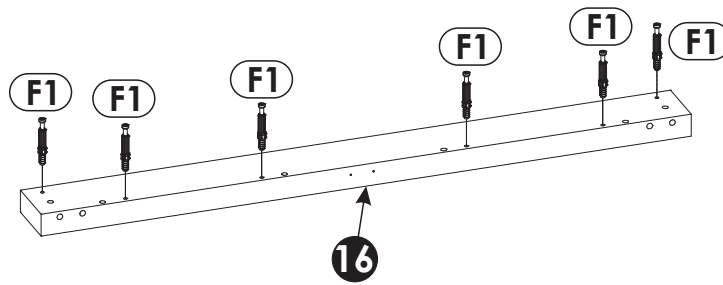
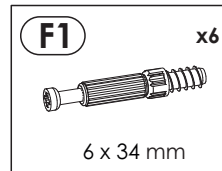
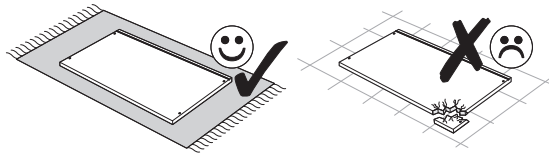

24 ▶

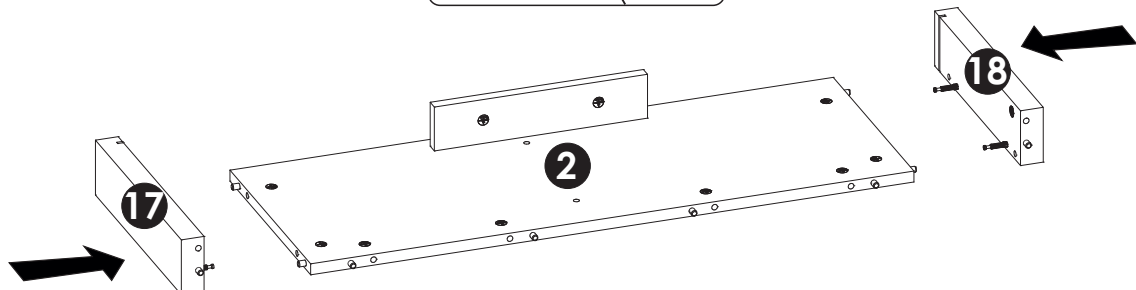
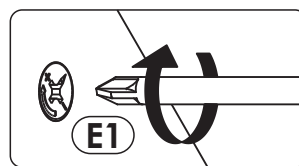
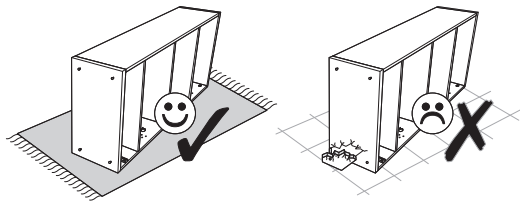

25 ▶▶

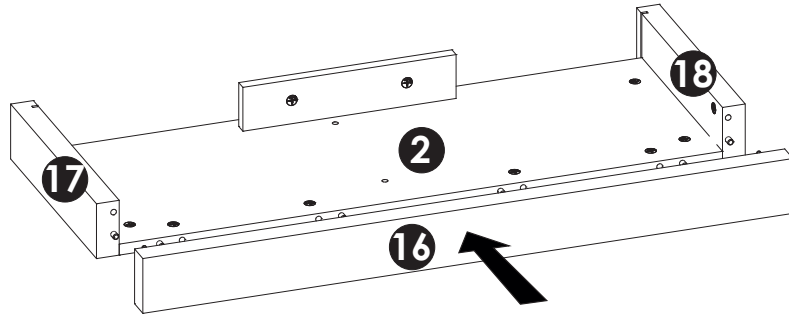
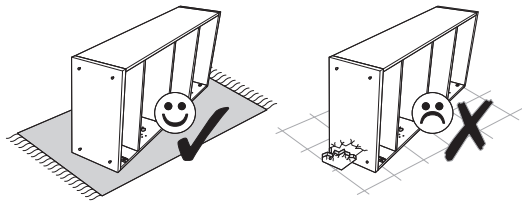

26 ▶▶

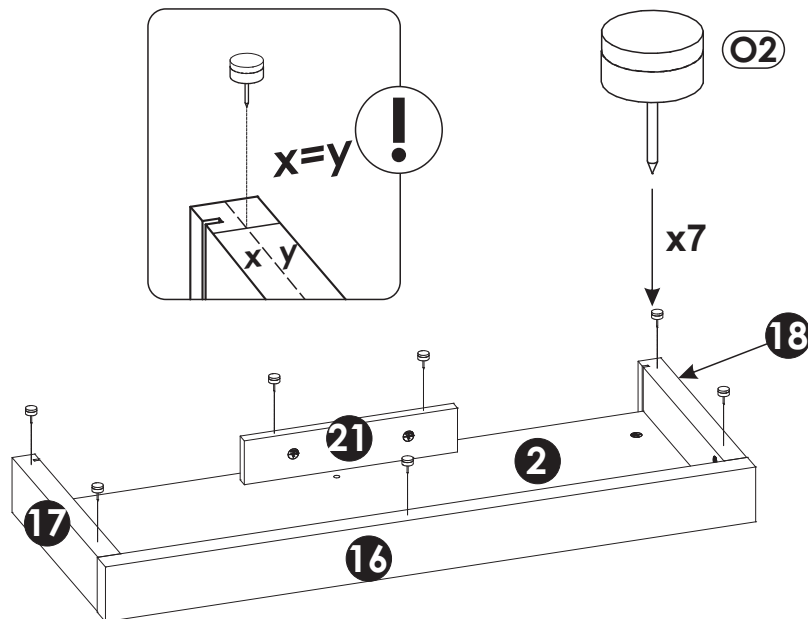
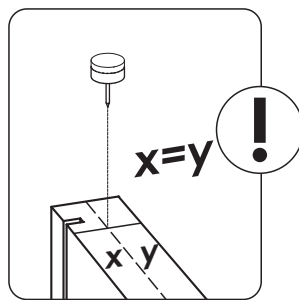
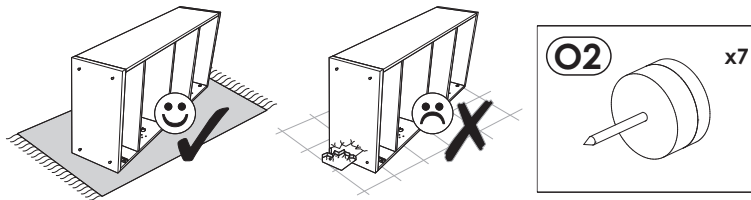

27 ▶

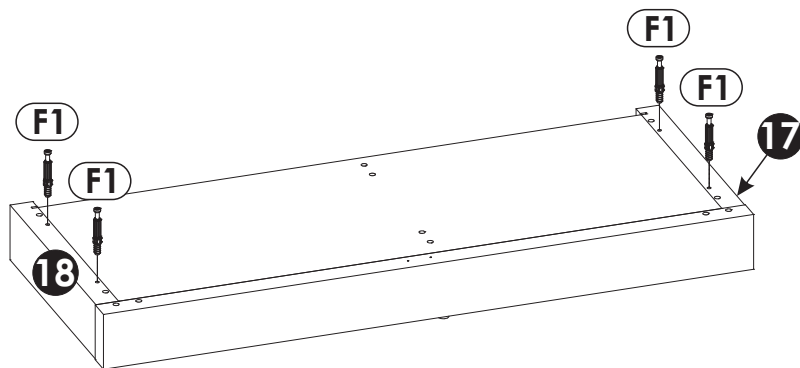
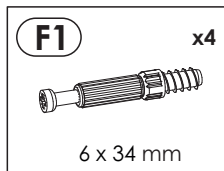
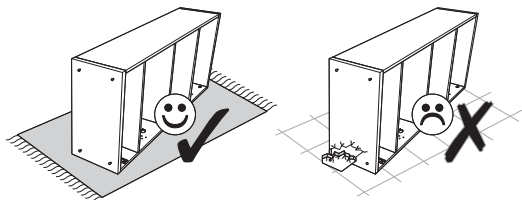

28 ▶

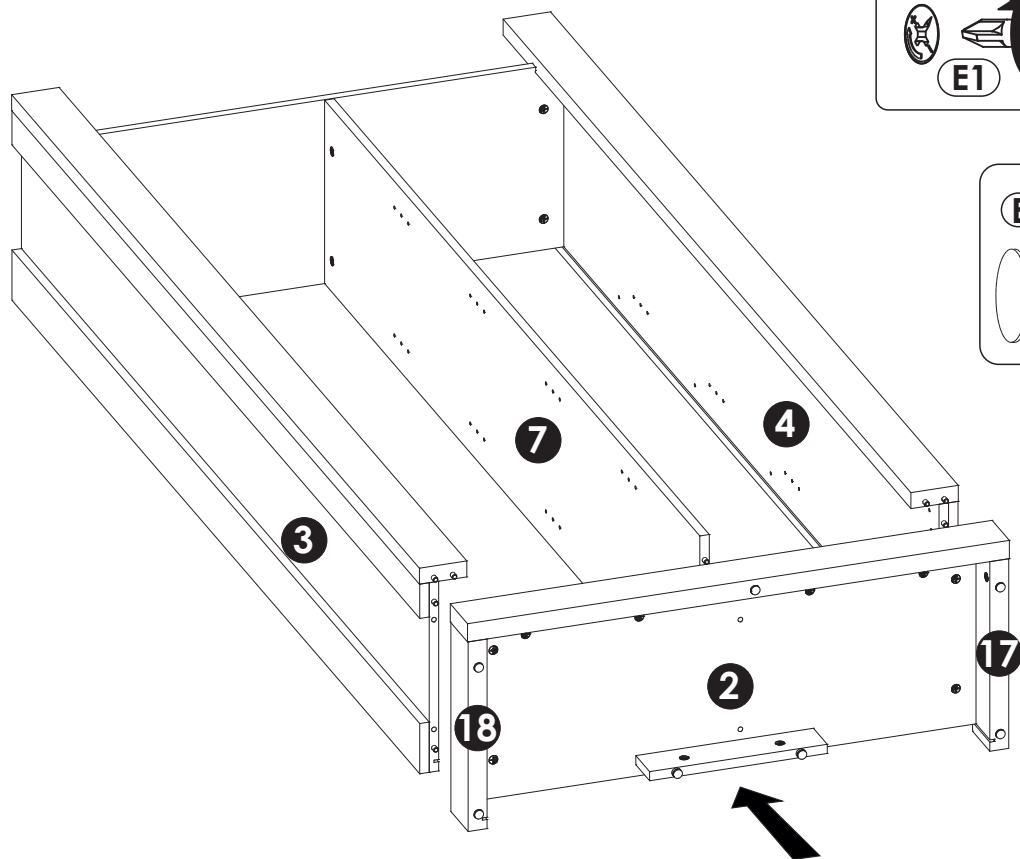
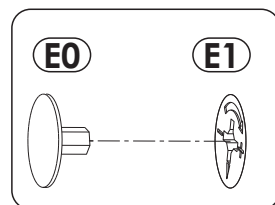
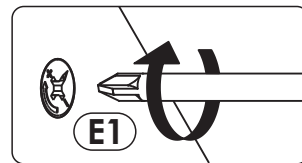
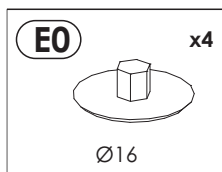
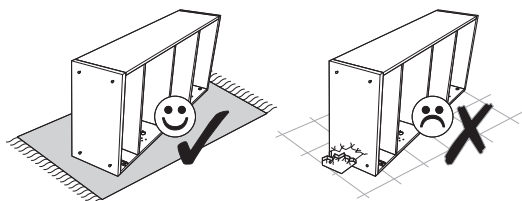

29 ▶▶

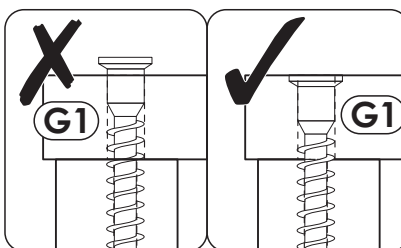
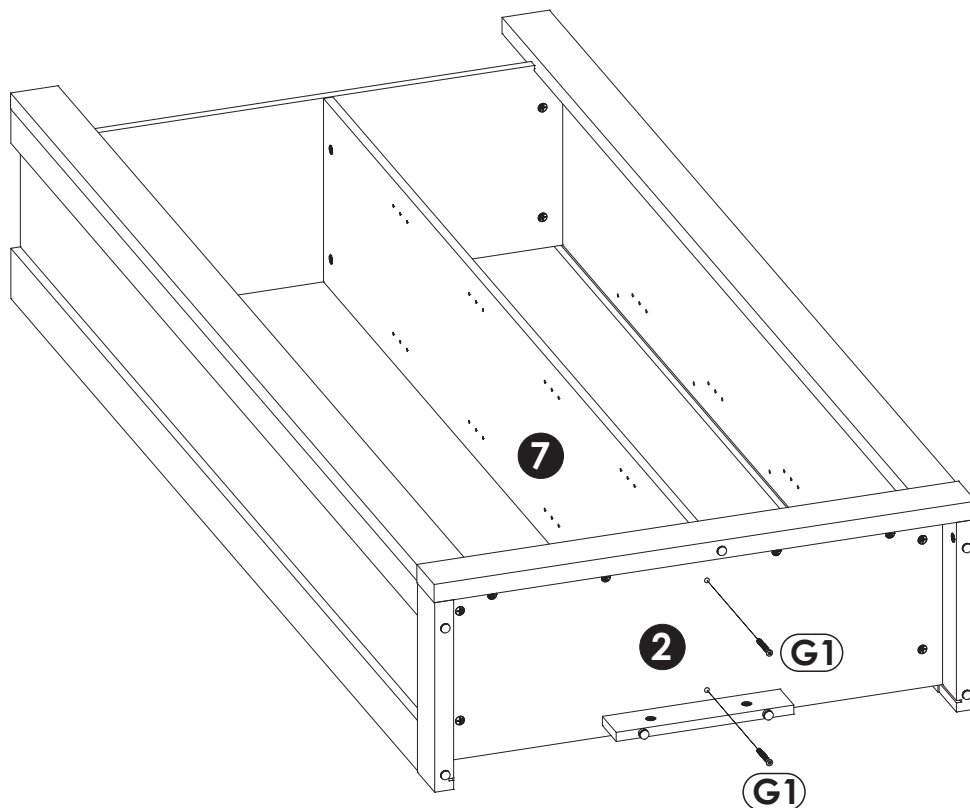
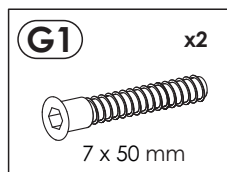
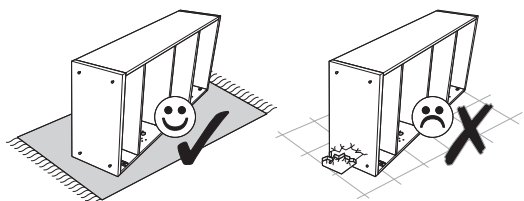

30 ▶▶

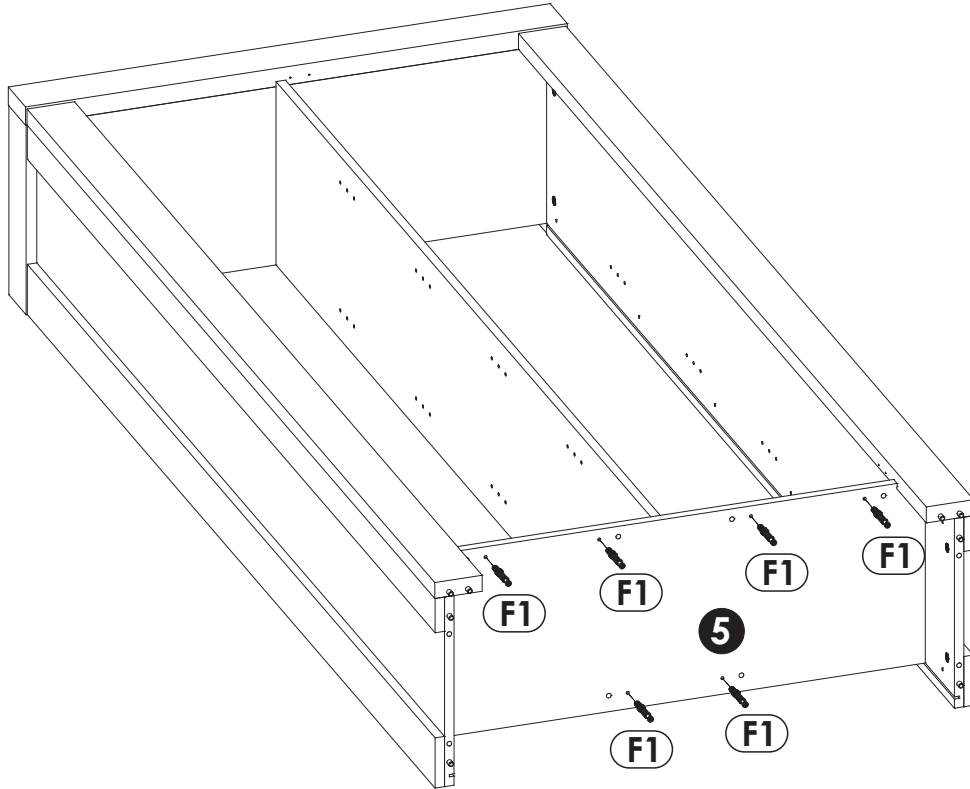
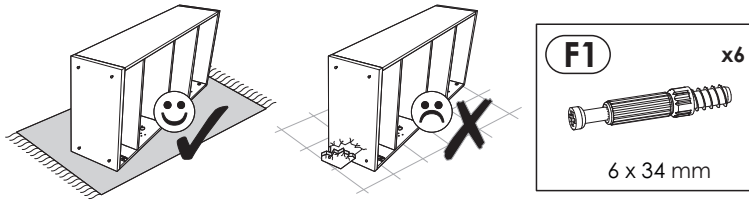

31.a ▶▶

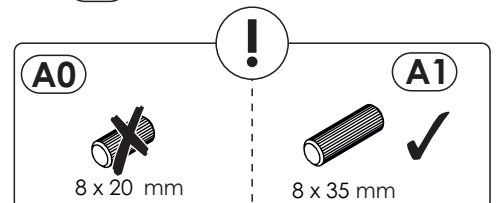
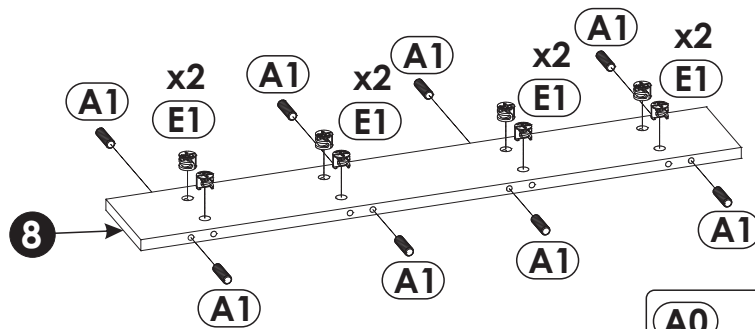
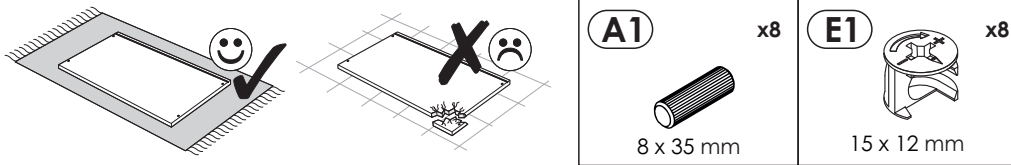

31.b ▶

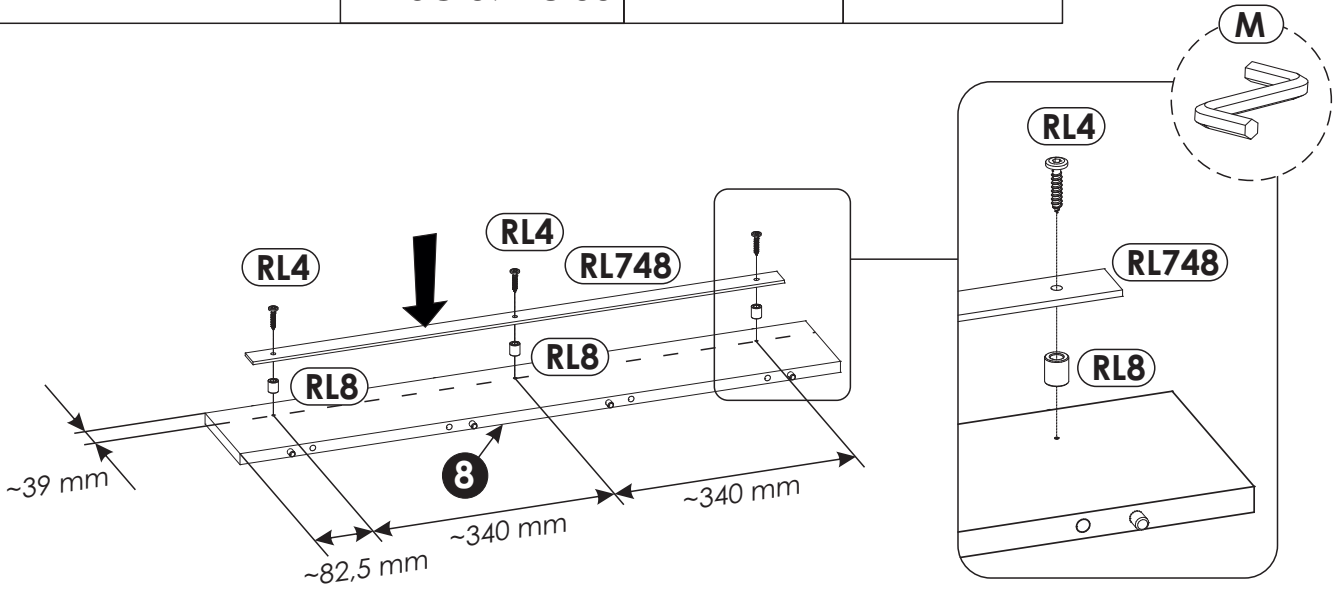
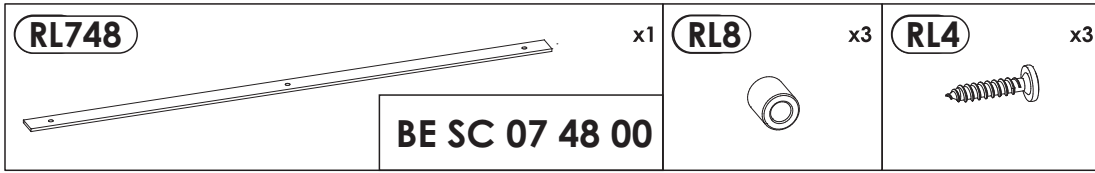
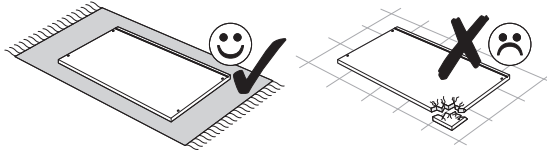

32 ▶

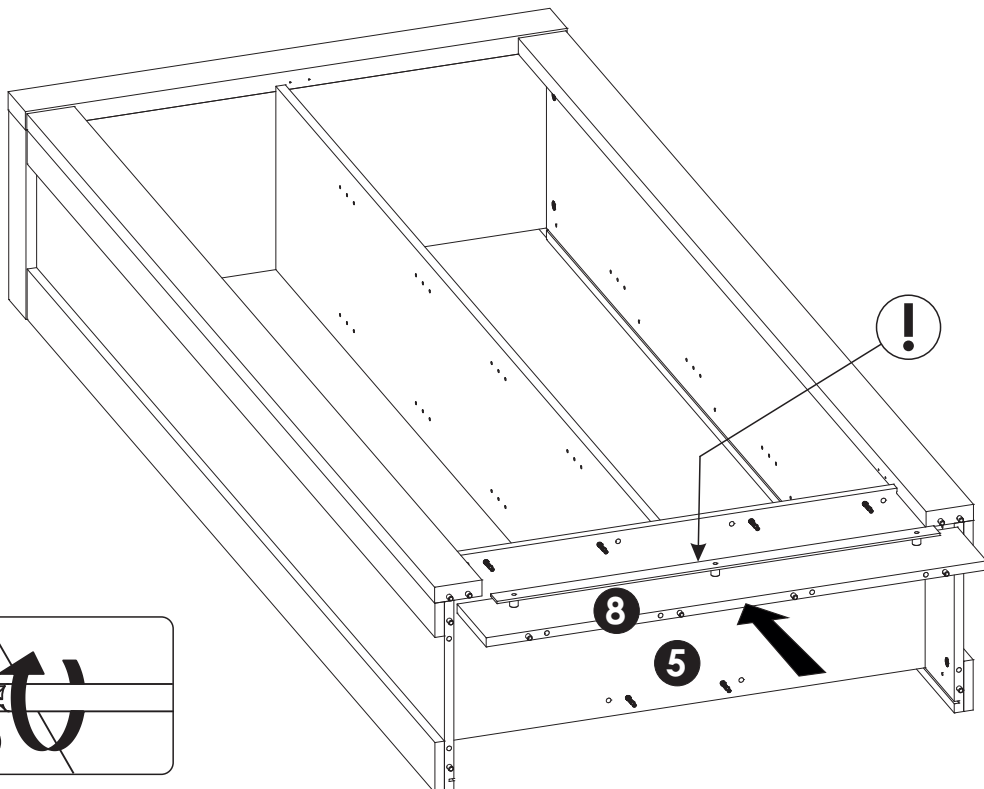
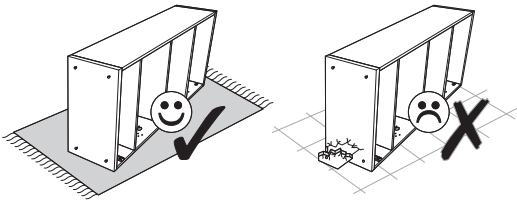

33 ▶

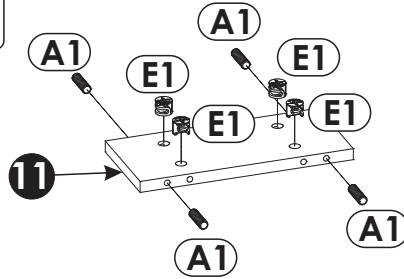
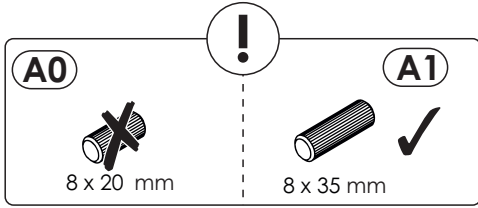
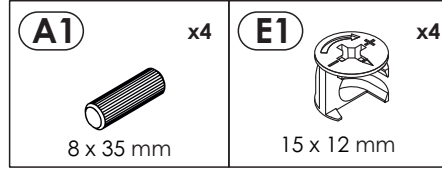
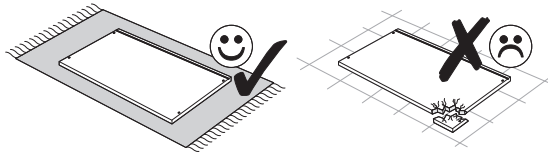

34 ▶

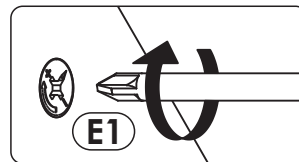
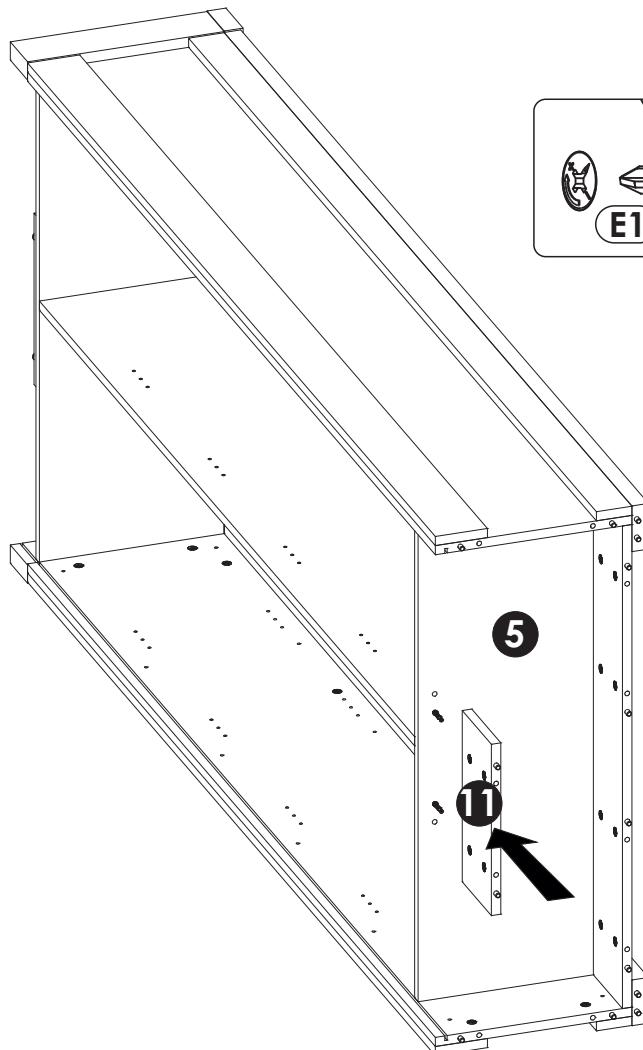
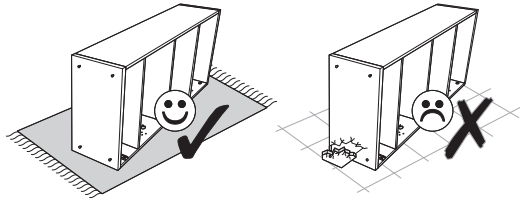

35 ▶

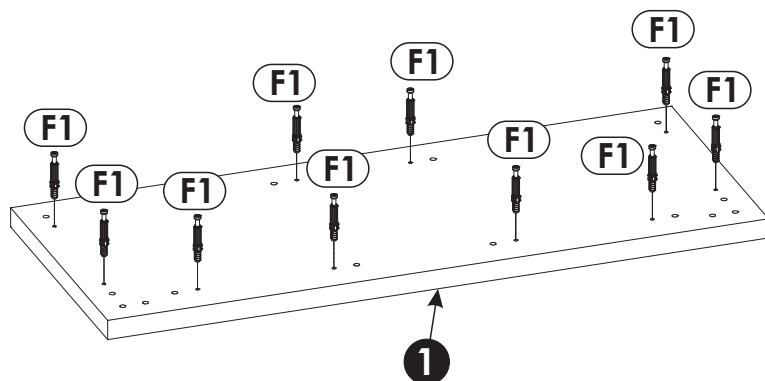
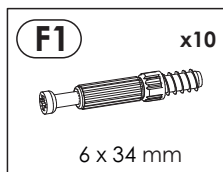
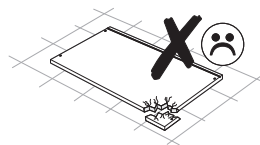
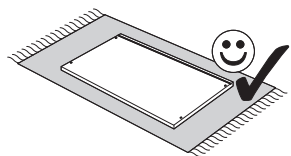

36 ▶

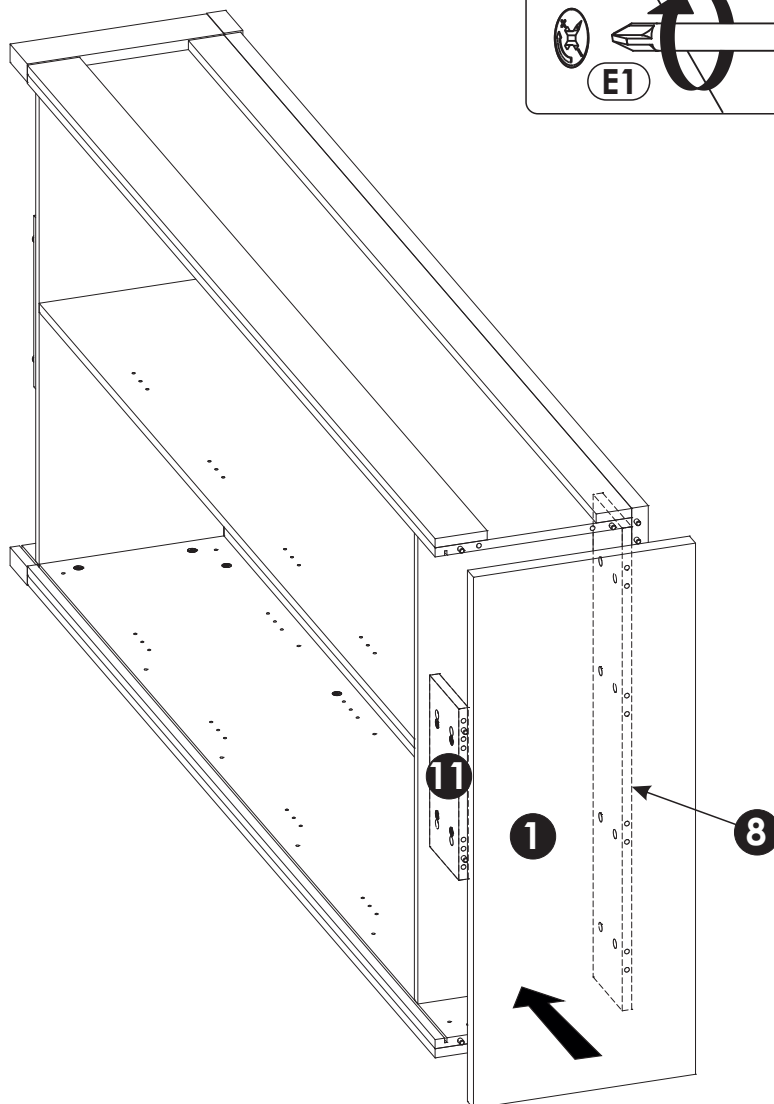
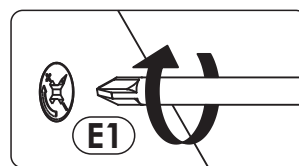
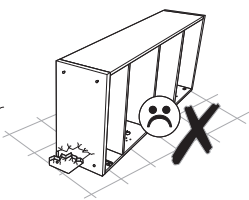
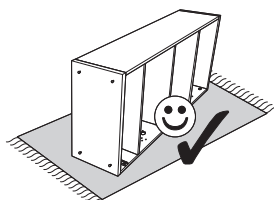

37 ▶

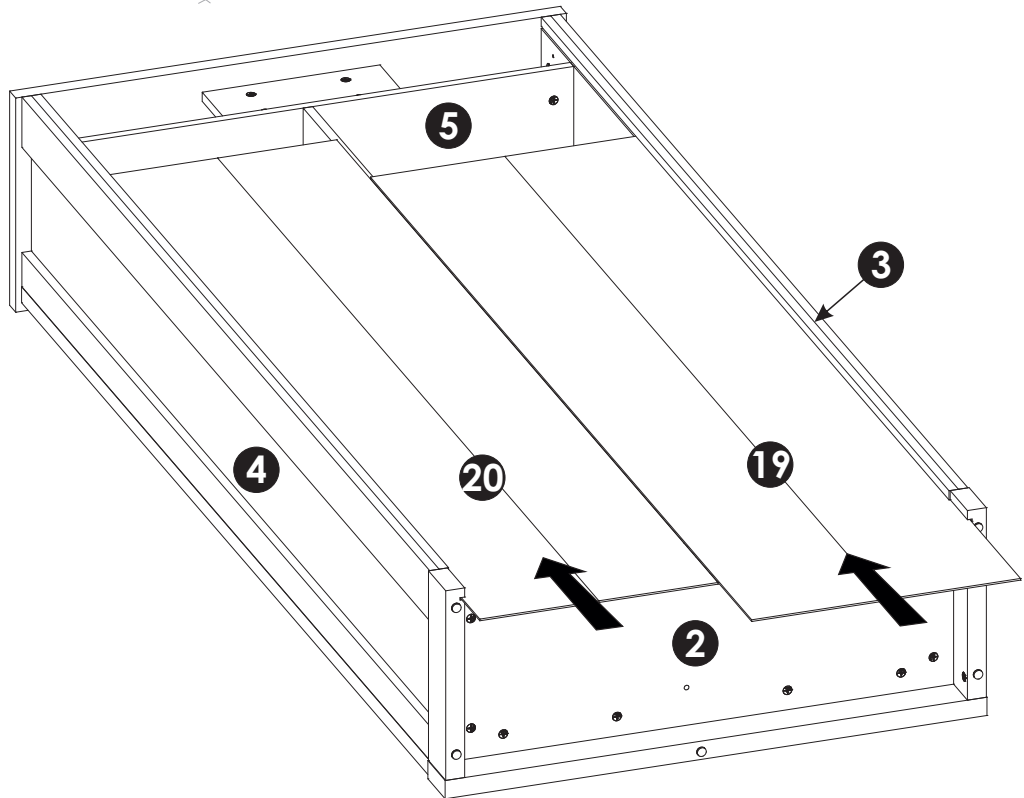
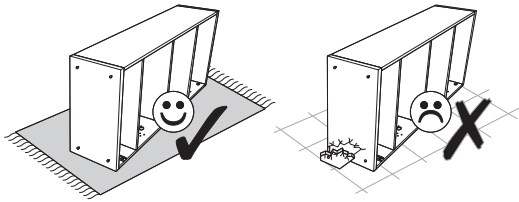

38 ▶

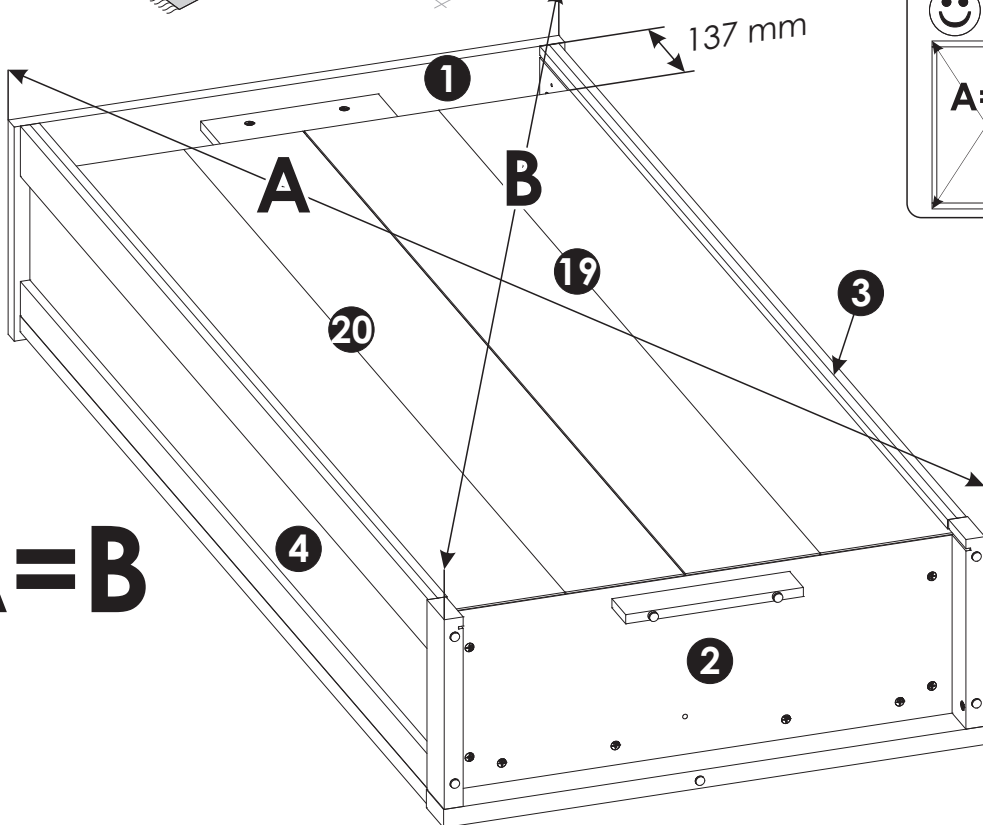
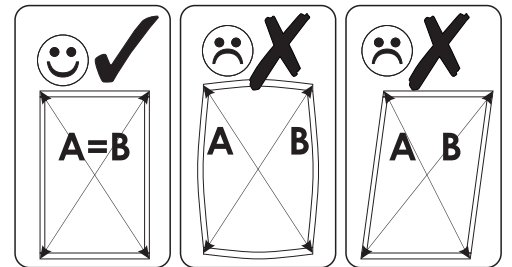
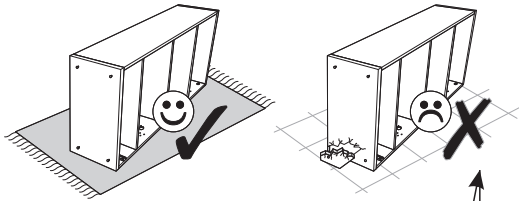

39 ▶

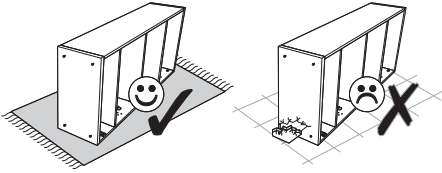

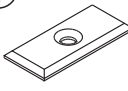
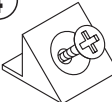
N1  3 X 16 mm	x23	R1 	x11	R4 	x8
-------------------------------------------------------------------------------------------------------------	-----	-------------------------------------------------------------------------------------------------	-----	--------------------------------------------------------------------------------------------------	----

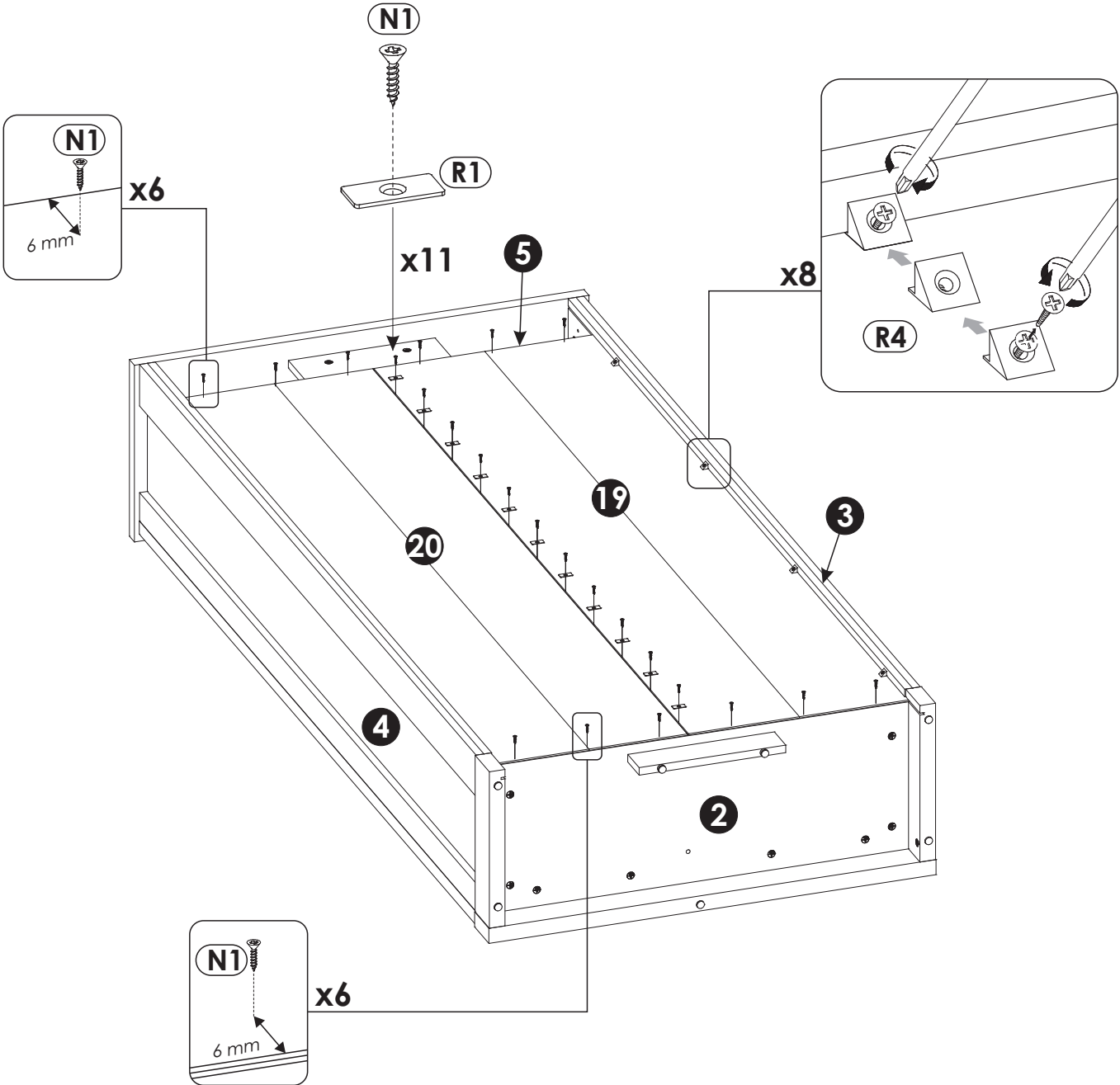

40 ▶

- I2** x2
4 x 16 mm
- Q9** x2
- Z** x1

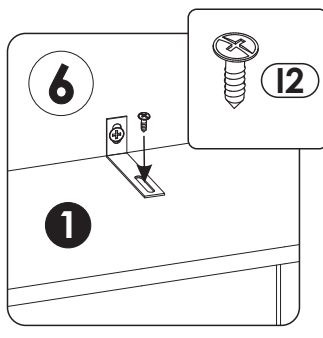
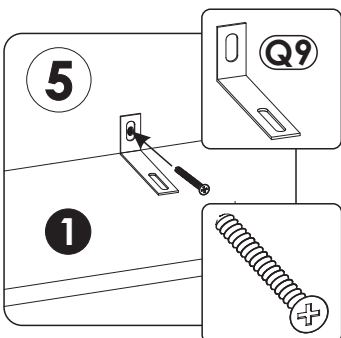
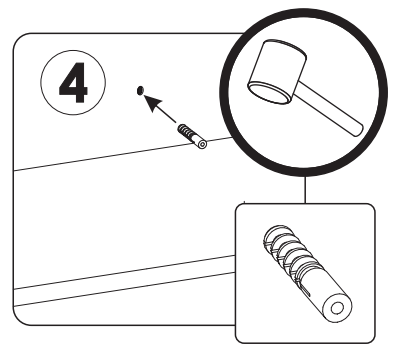
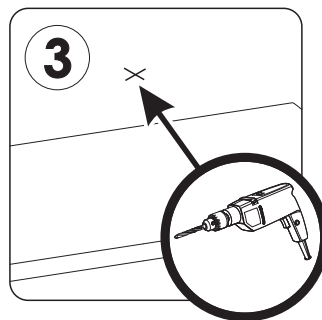
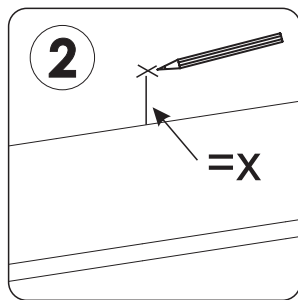
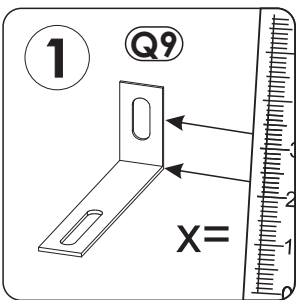
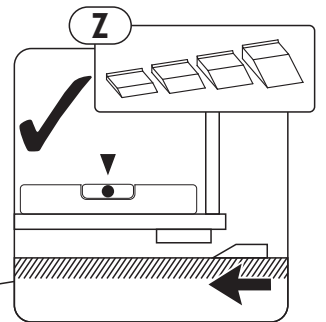
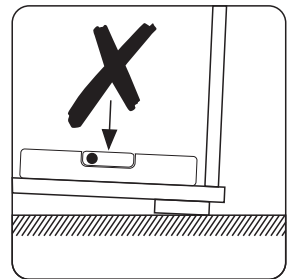
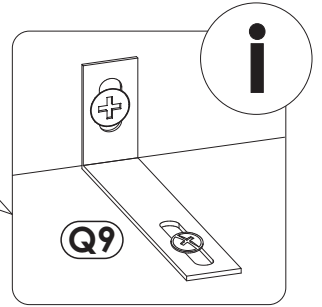
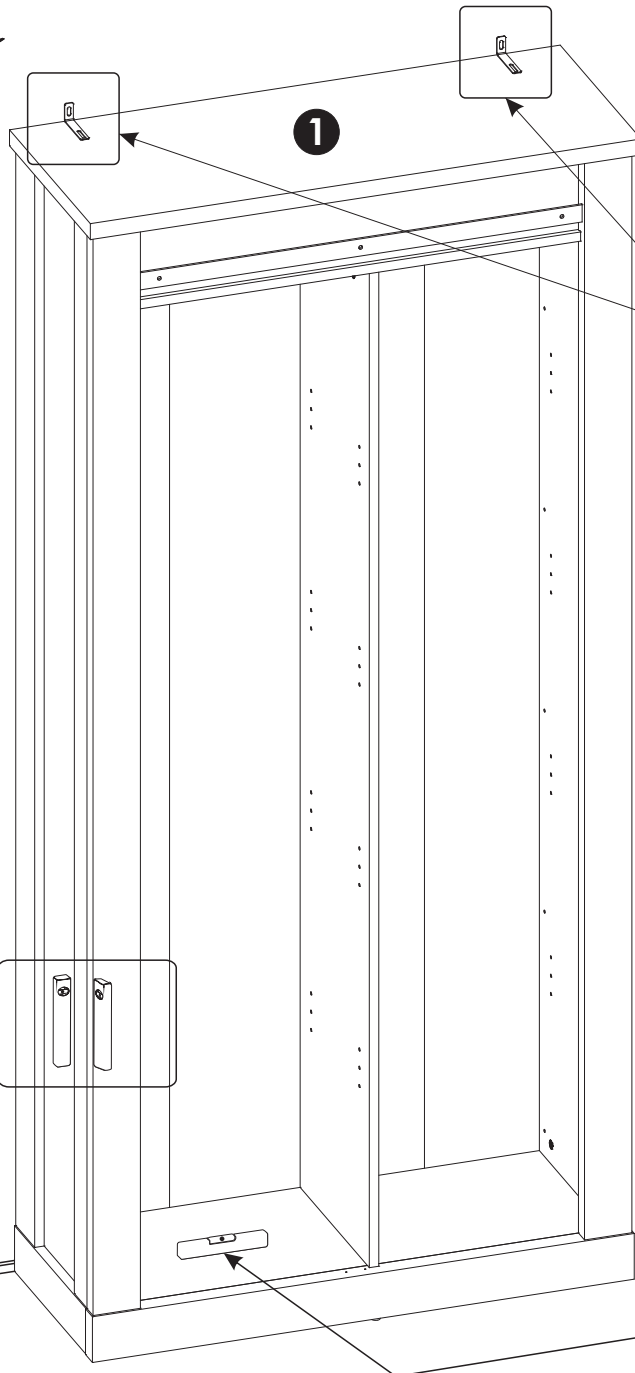
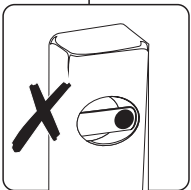
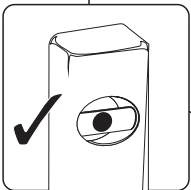

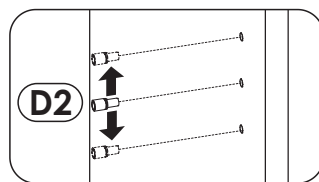
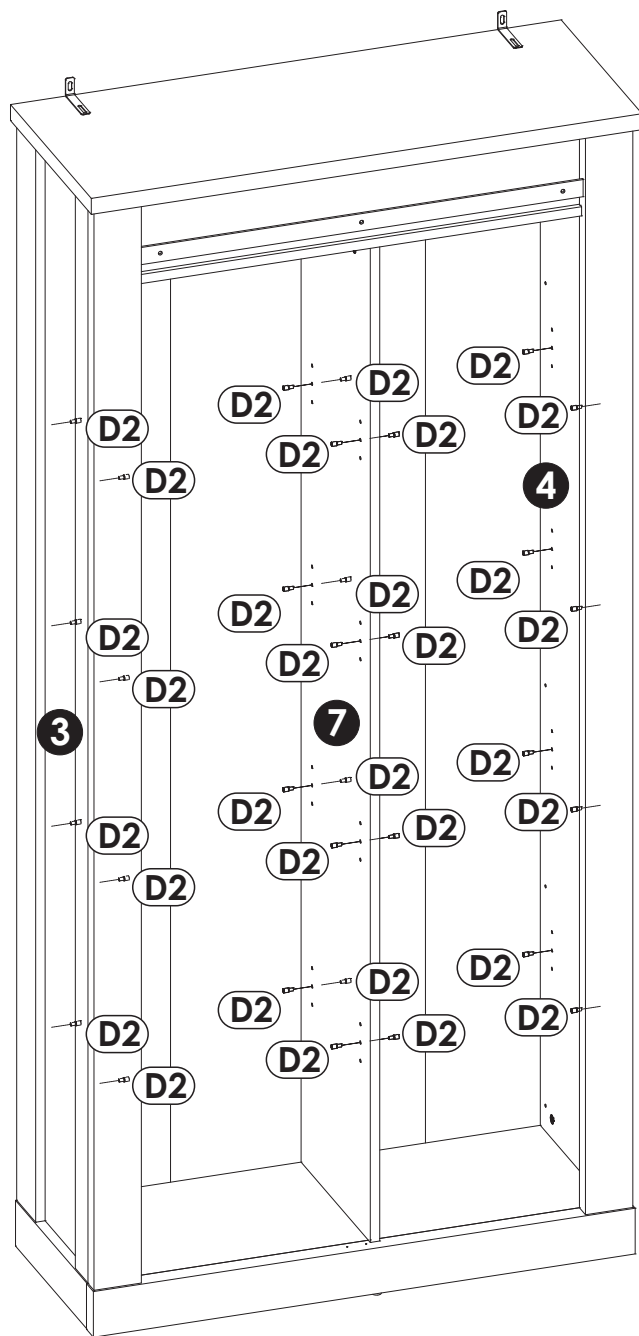
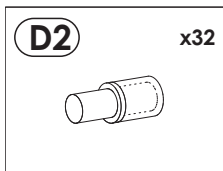

41 ▶

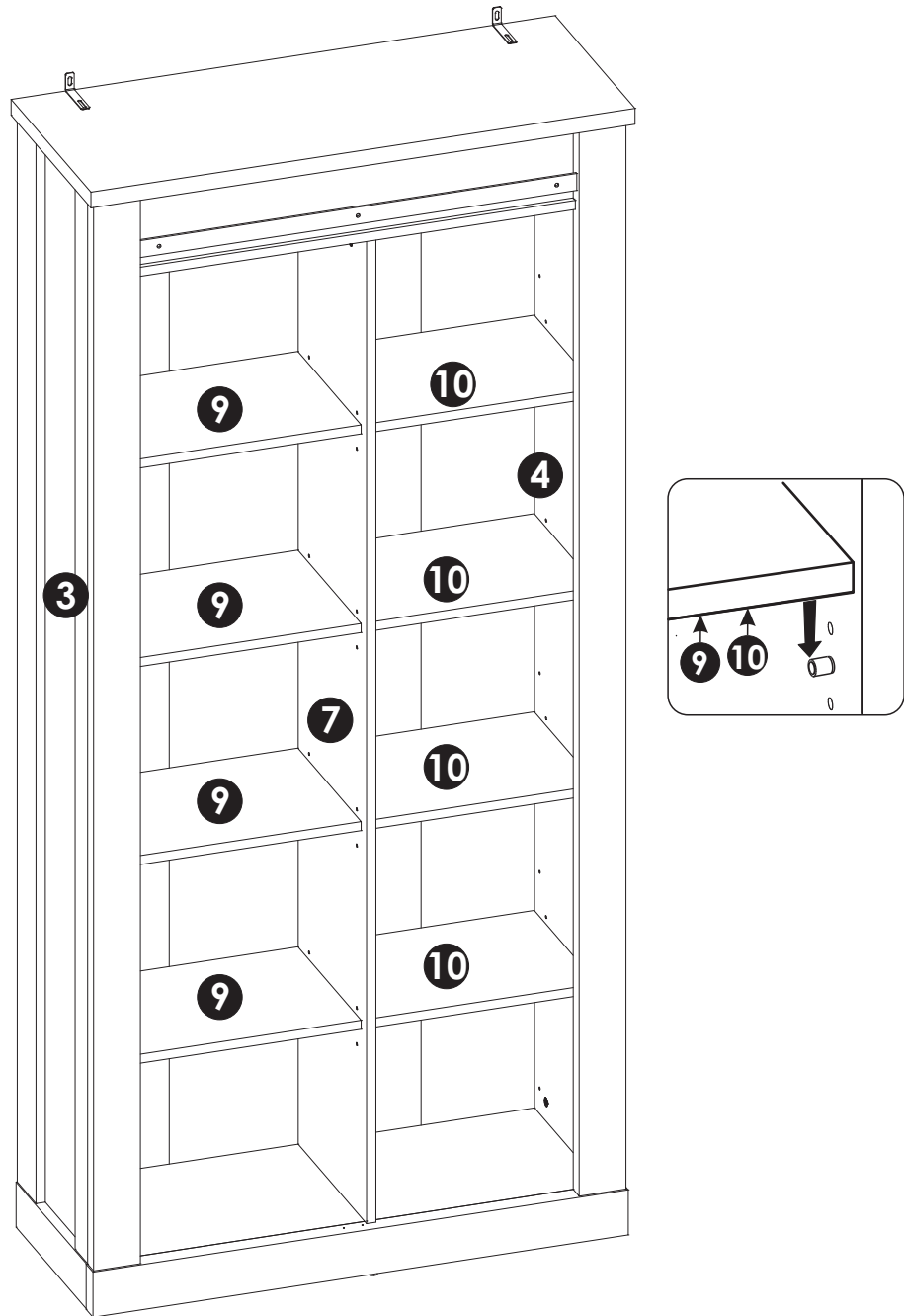

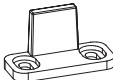

43 ▶

I0	x2	R10	x1	RL2	x2	RL7	x1
							
3 x 13 mm							

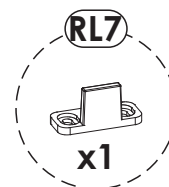
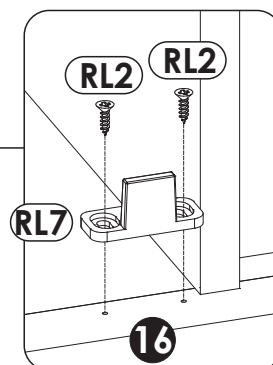
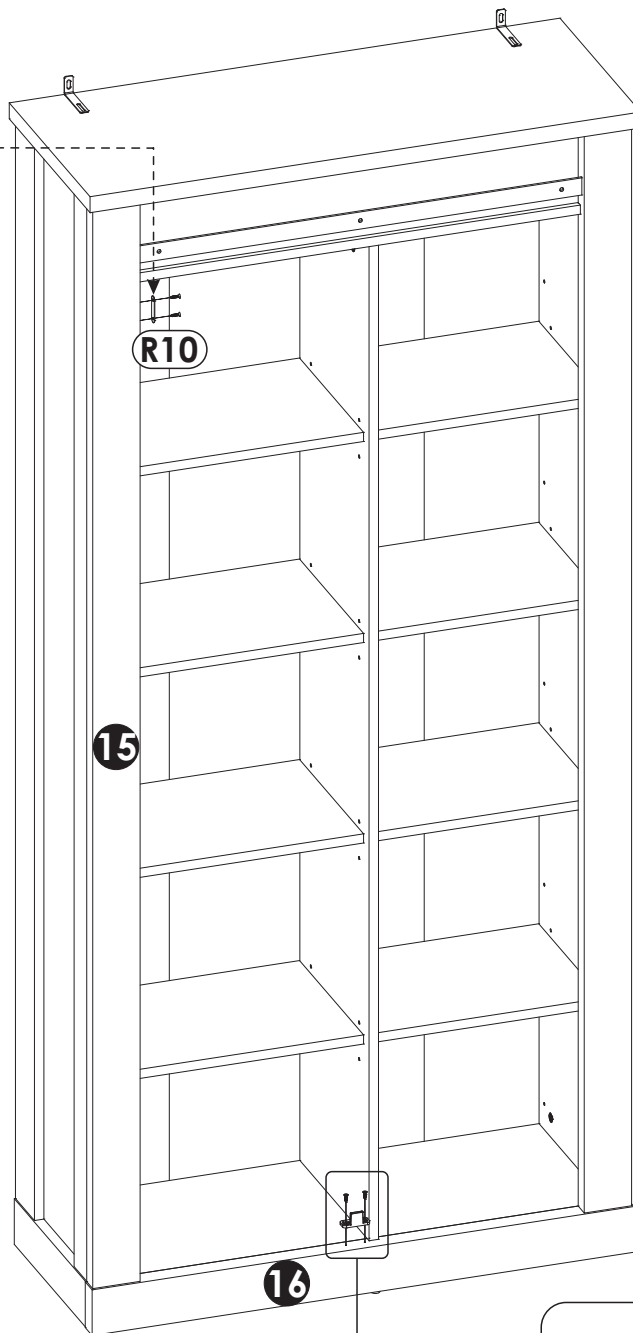
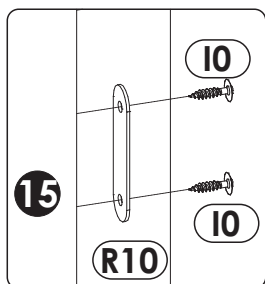

44 ▶

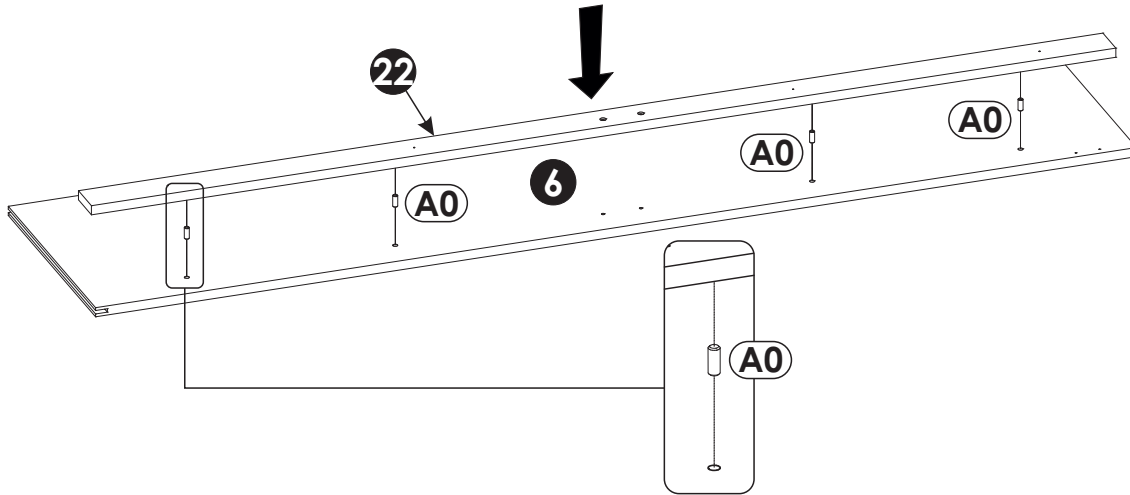
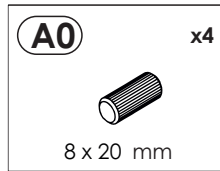
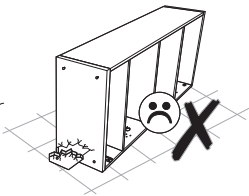
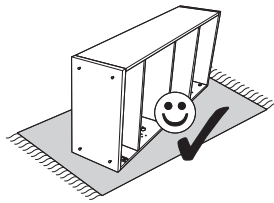

45 ▶

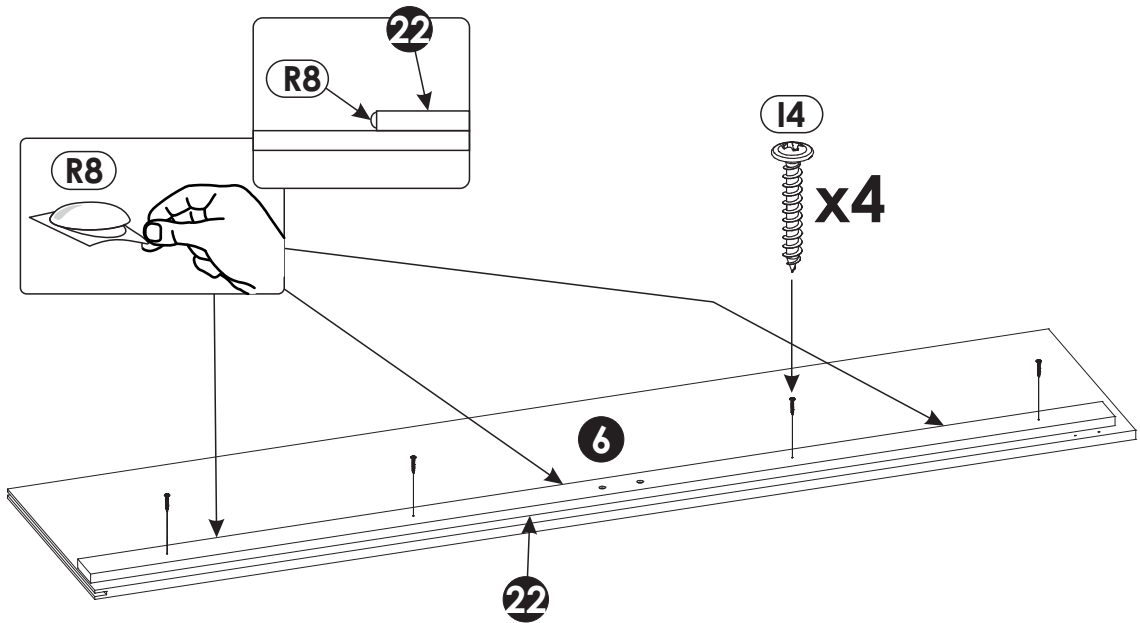
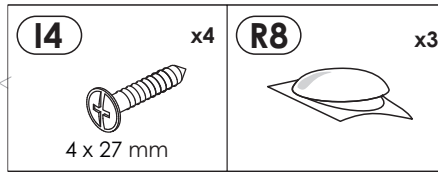
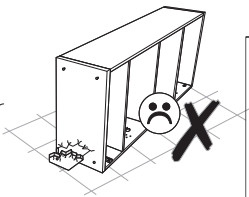
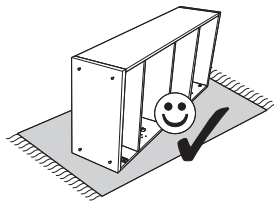

46 ▶

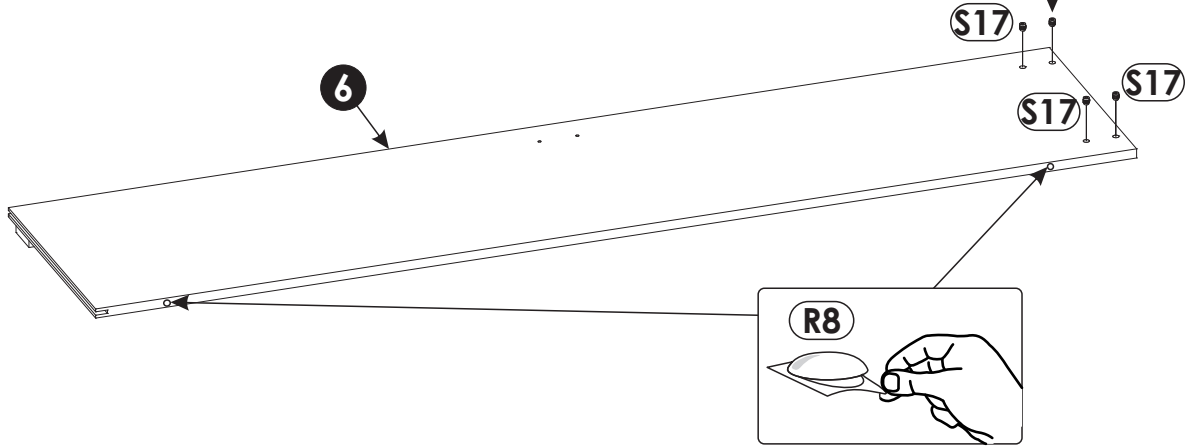
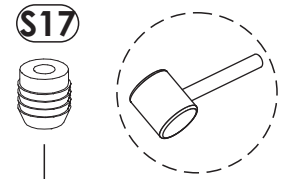
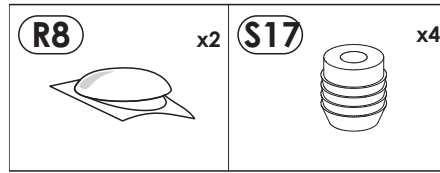
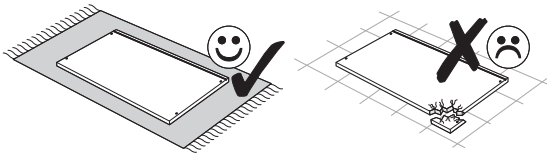

47 ▶

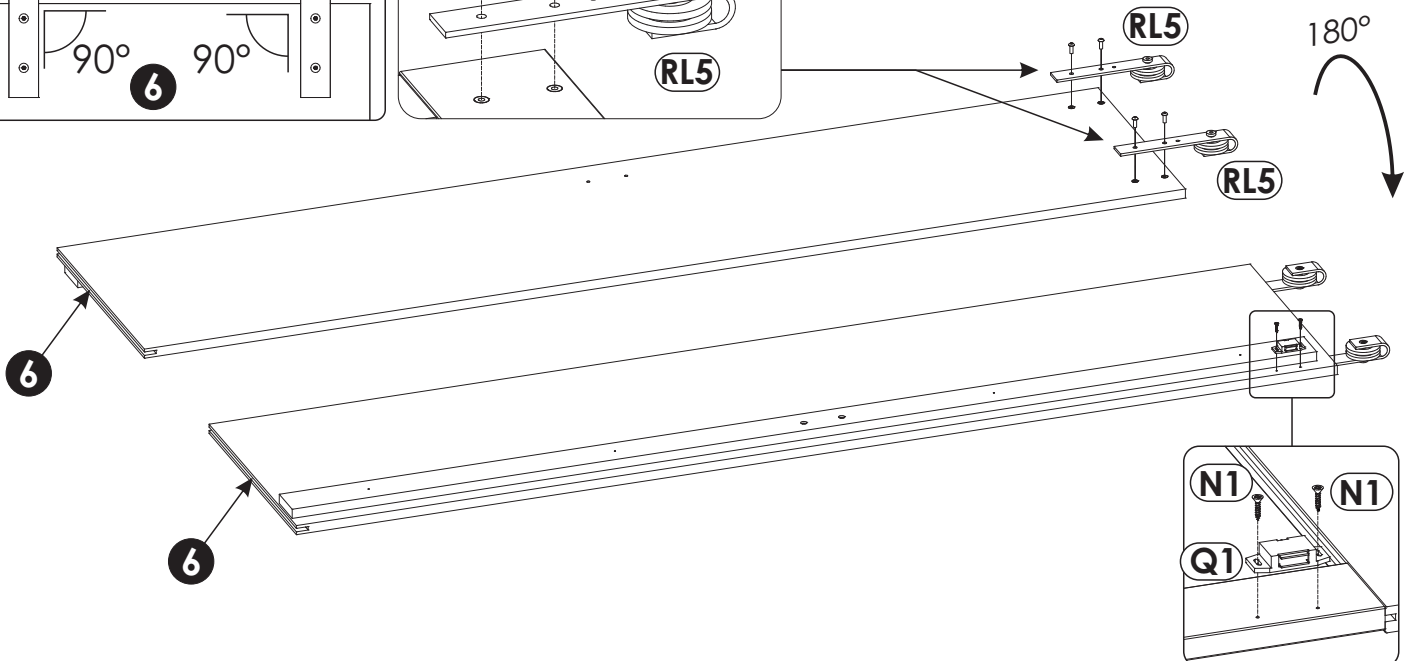
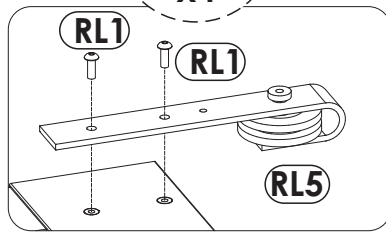
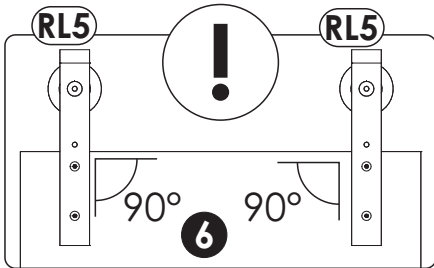
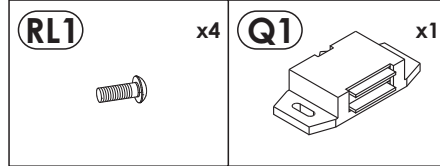
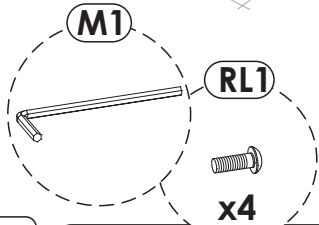
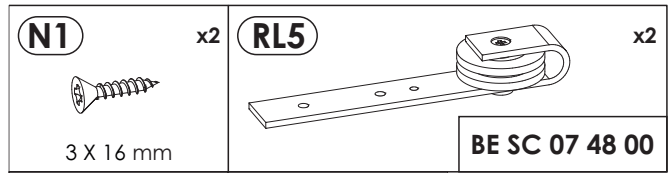
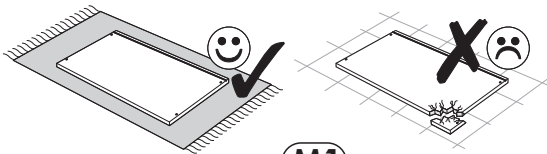

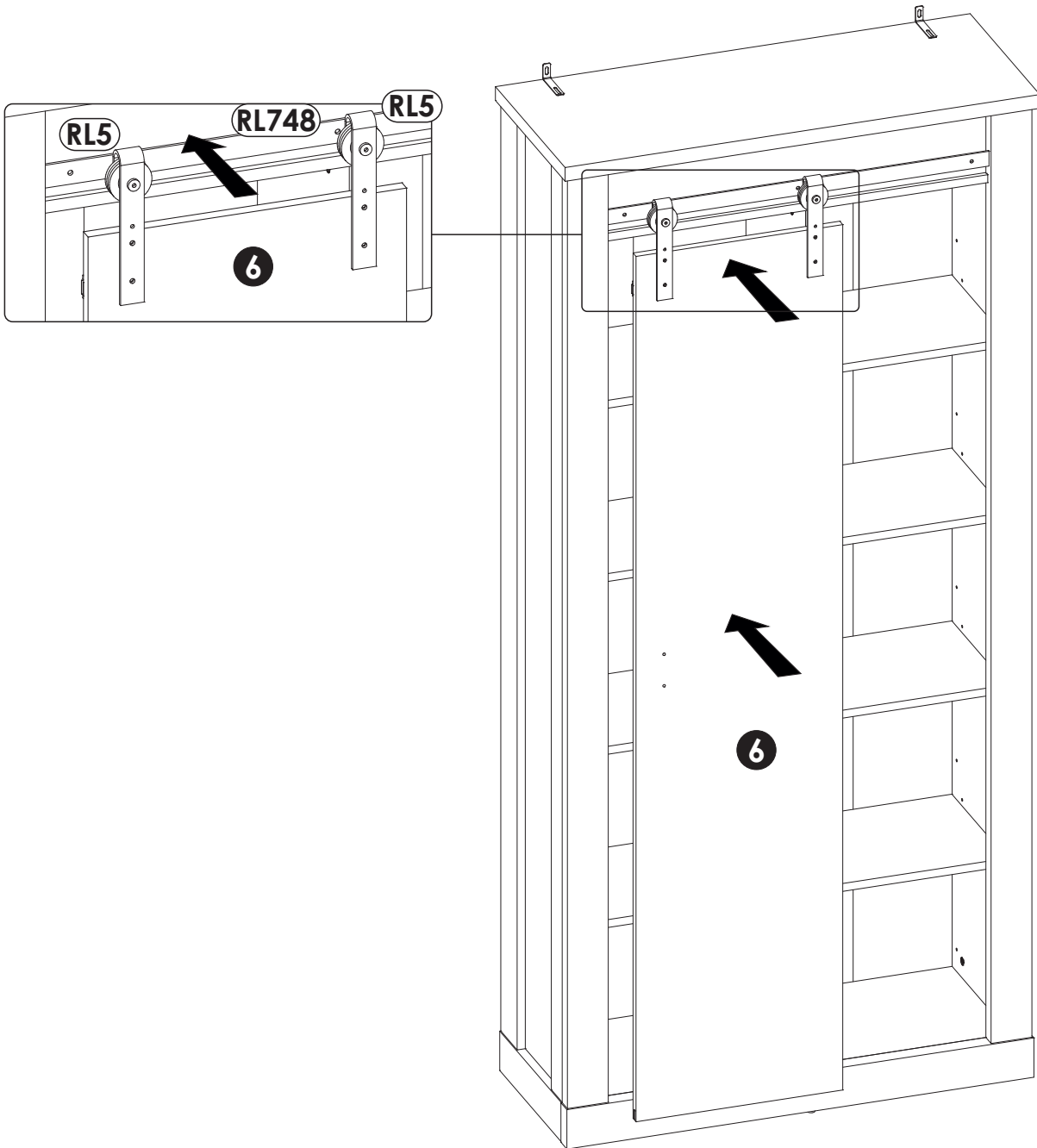

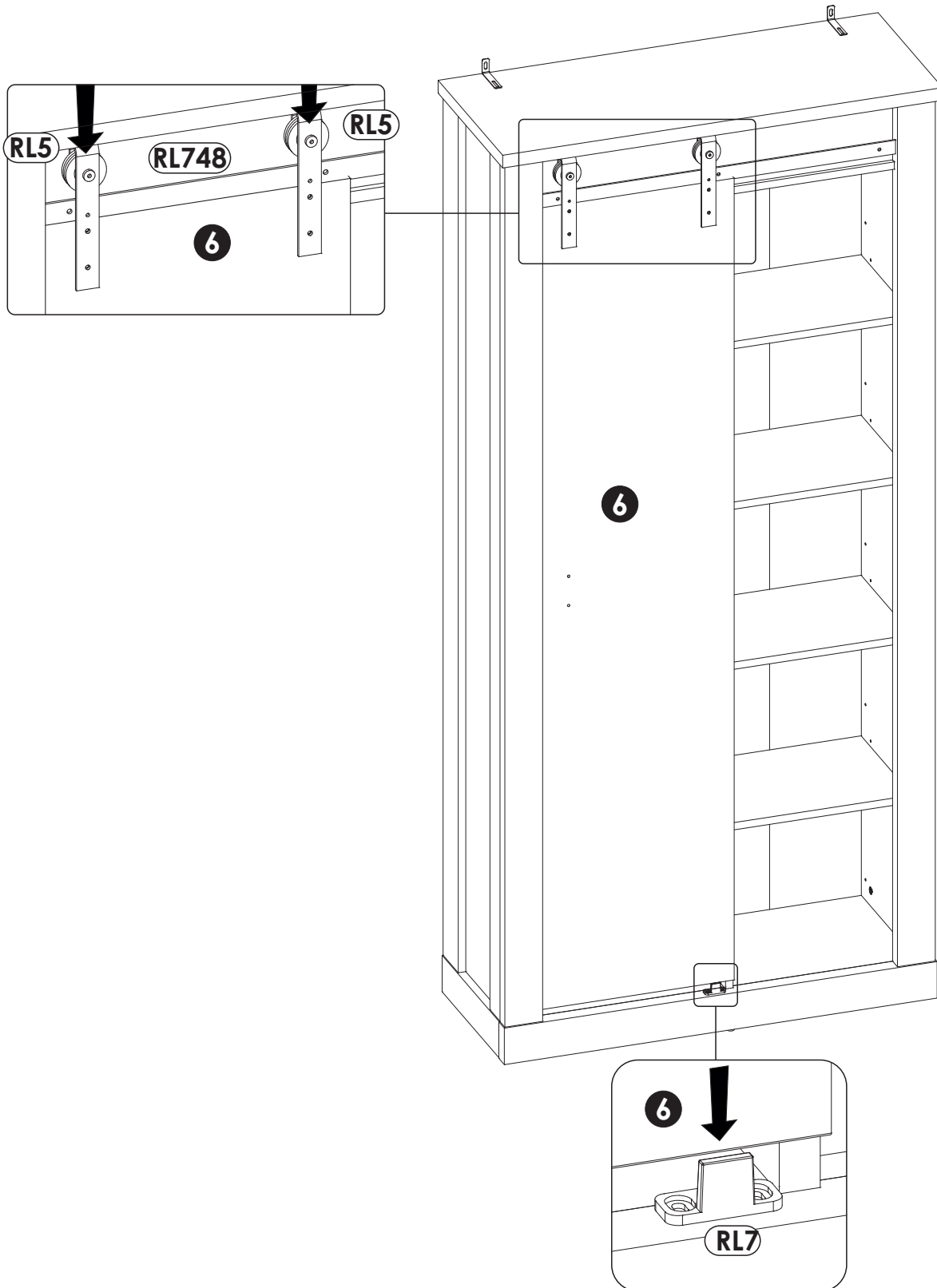

50 ▶

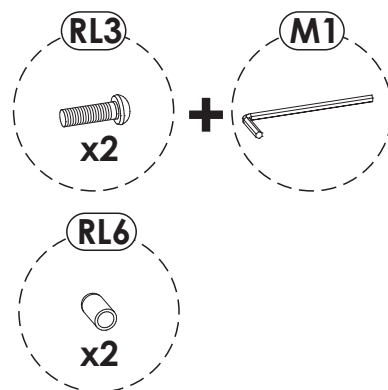
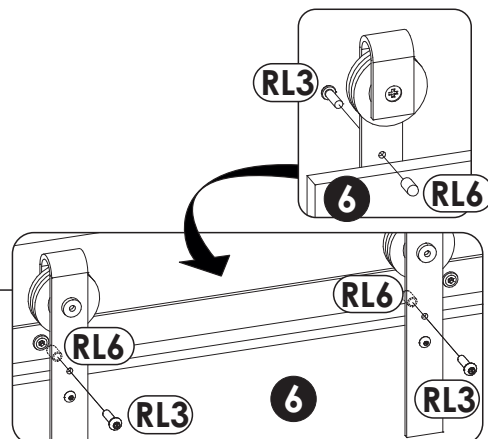
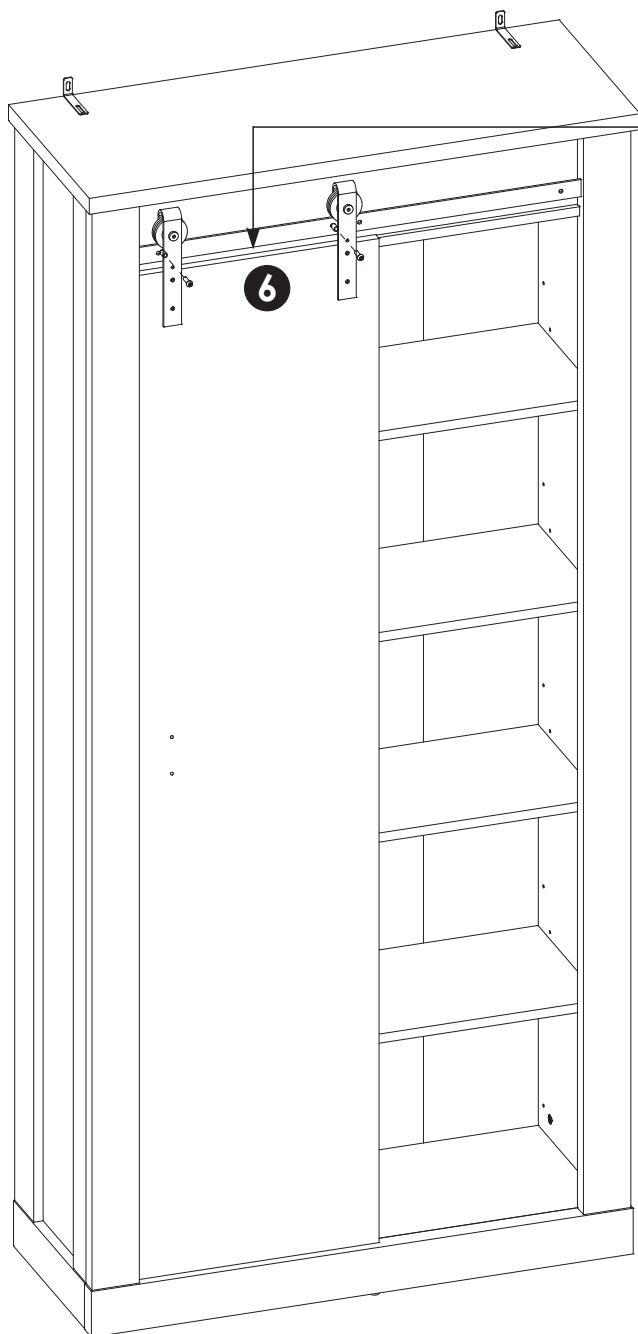
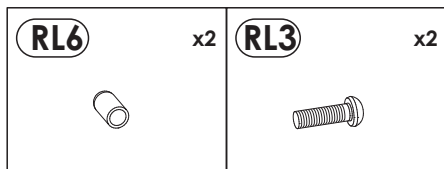

51 ▶

