

KONIFERA

13 tlg Belluno

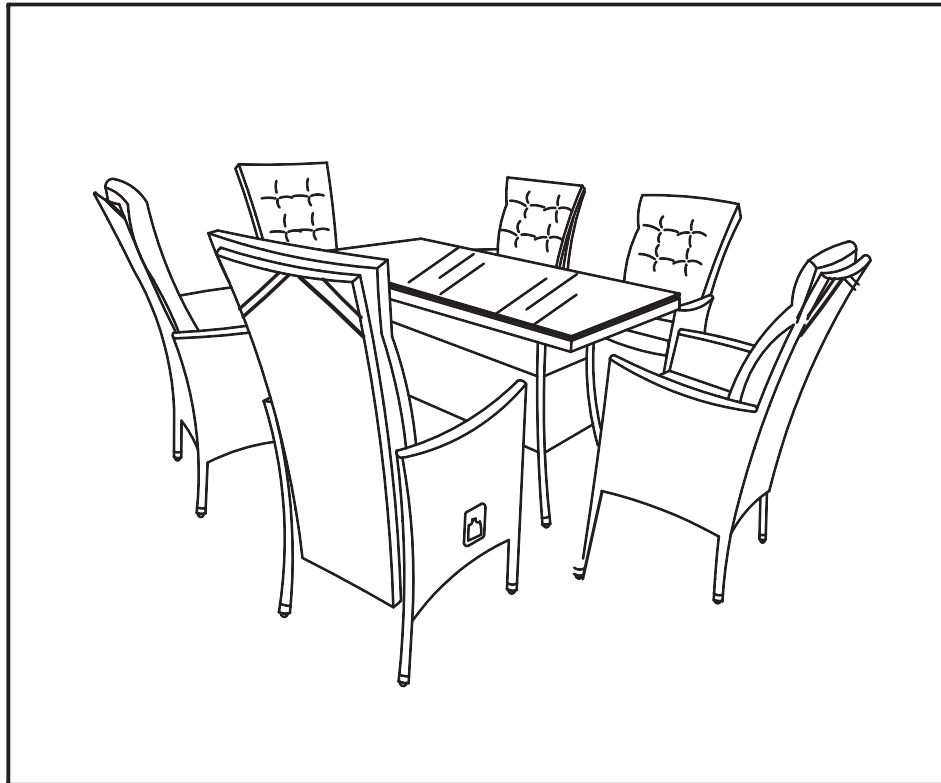

- | | | | |
|----|-----------------------------|----|-------------------------|
| ⒹⒺ | Montageanleitung | ⒸⒺ | Assembly instructions |
| ⒻⒻ | Notice de montage | ⒾⒹ | Istruzioni di montaggio |
| ⒶⒻ | Handleiding voor de montage | ⓅⒻ | Instrukcja montażu |
| ⒸⒿ | Montážní návod | ⒶⒾ | Návod na montáž |
| Ⓗ⒰ | Szerelési utmutato | ⓇⒺ | Instrucțiuni de montaj |
| ⓉⓇ | Montaj talimatı | Ⓡ⒰ | Инструкция по монтажу |

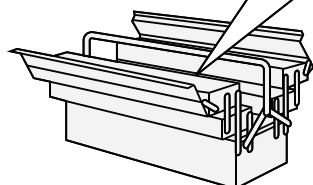
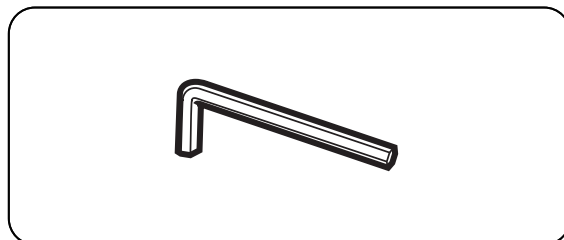
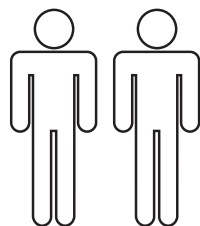

DE

- Befolgen Sie stets die Anleitungen des Herstellers.
- Sorgen Sie dafür, dass Glasflächen genügend Abstand zu heißen oder sehr kalten Gegenständen haben.
- Stoßen Sie nicht mit harten Gegenständen an die Glasflächen oder -kanten.
- Setzen, stellen oder stützen Sie sich nie auf die Glasflächen.
- Der Artikel ist kein Kinderspielzeug! Lassen Sie Kinder auch nicht mit der Verpackung spielen. Sie könnten an der Folie ersticken oder sich an der Umverpackung verletzen.
- Achten Sie darauf, dass Kinder keine kleinen Teile, wie z. B. Muttern, Abdeckkappen oder Ähnliches in den Mund nehmen. Sie könnten sie verschlucken und daran ersticken.
- Um Verletzungen und Quetschungen zu vermeiden, verstellen, falten, öffnen oder schließen Sie den Artikel vorsichtig.
- Nur wenn alle Teile ordnungsgemäß arretiert sind, kann eine sichere Benutzung des Artikels gewährleistet werden.
- Ziehen Sie alle Schrauben sowie tragende Verbindungsteile nach ca. 5 Wochen nach, um eine dauerhafte Standsicherheit zu gewährleisten.

GB

- Always follow the instructions of the manufacturer.
- Ensure that glass surfaces are situated at an adequate distance from hot or very cold objects.
- Do not bump glass surfaces or edges with hard objects.
- Never sit, stand, or lean on the glass surfaces.
- This product is not a toy! Do not allow children to play with the packaging. They could suffocate in the foil or injure themselves on the packaging.
- Ensure that children do not put any small parts such as nuts, caps, or the like in their mouth. They could swallow and choke on them.
- To avoid injury and crushing, adjust, fold, open or close the item carefully.
- Safe use of the item can only be guaranteed if all parts are properly locked in place.
- After approx. 5 weeks, tighten all screws and load-bearing connecting parts to ensure permanent stability.

FR

- Suivez toujours les instructions du fabricant.
- Le remplacement des vérins pneumatiques ou les travaux effectués dessus ne pourront être réalisés que par du personnel spécialisé formé.
- Faites en sorte que les surfaces vitrées soient à distance suffisante d'objets chauds ou très froids.
- Ne frappez pas sur la surface ou le bord de la vitre avec un objet dur.
- Ne vous asseyez pas, ne montez pas ou ne vous appuyez pas sur les surfaces vitrées.
- L'article n'est pas un jouet ! Ne laissez pas non plus les enfants jouer avec la feuille d'emballage en plastique. Ils peuvent s'asphyxier avec le film plastique ou se blesser avec les moyens d'emballage.
- Veillez à ce que les enfants ne mettent aucune petite pièce, comme p. ex. des écrous, des capuchons ou similaires, dans la bouche. Ils peuvent les avaler et s'étouffer.
- Une utilisation sûre de l'article ne peut être garantie que si toutes les pièces sont correctement bloquées.
- Resserrez toutes les vis ainsi que les pièces de fixation au bout d'environ 5 semaines pour garantir une sécurité de fixation durable.

IT

- Seguire sempre le istruzioni del produttore.
- La sostituzione dei pistoncini o eventuali interventi sui pistoncini possono essere eseguiti solo da personale qualificato addestrato.
- Assicurarsi che le superfici vetrate si trovino a distanza sufficiente da oggetti molto caldi o molto freddi.
- Evitare di colpire con oggetti contundenti le superfici o gli spigoli di vetro.
- Non sedersi, appoggiarsi o sorreggersi sulle superfici vetrate.
- L'articolo non è un giocattolo! Non permettere ai bambini neanche di giocare con l'imballaggio. Rischio di soffocamento per via della pellicola o di lesioni per via dell'imballaggio esterno.
- Assicurarsi che i bambini non portino alla bocca le parti piccole, ad es. dadi, coperchietti e simili. Potrebbero ingerirle e soffocare.

- L'uso sicuro dell'articolo può essere garantito solo se tutte le parti sono correttamente bloccate in posizione.
- Ristringere tutte le viti e giunture dopo ca. 5 settimane, al fine di garantire una durevole solidità.

NL

- Volg steeds de instructies van de fabrikant.
- De vervanging van de gasdrukveer resp. het werk eraan mag alleen gebeuren door geschoolde vaklui.
- Zorg ervoor dat de glazen oppervlakken op voldoende afstand staan van hete of zeer koude voorwerpen.
- Stoot niet met harde voorwerpen tegen de glazen oppervlakken of randen.
- Ga niet zitten, staan op of leunen tegen de glazen oppervlakken.
- Het artikel is geen speelgoed voor kinderen! Zorg ervoor dat kinderen ook niet met de verpakking spelen. Ze kunnen stikken door de folie of zich verwonden aan de verpakking.
- Zorg ervoor dat kinderen geen kleine stukken, zoals moeren, afdekkapjes of dergelijke in de mond nemen. Ze kunnen ze inslikken en daardoor stikken.
- Alleen als alle onderdelen correct zijn vergrendeld, kan een veilig gebruik van het artikel worden gegarandeerd.
- Draai alle schroeven en ook dragende verbindingstukken na ca. 5 weken nog eens vast, zodat een continue stabiliteit wordt gegarandeerd.

PL

- Zawsze należy przestrzegać instrukcji producenta.
- Wymiana lub inne prace wykonywane przy amortyzatorach gazowych mogą być przeprowadzane tylko przez przeszkolony personel.
- Powierzchnie szklane powinny znajdować się w znacznej odległości od przedmiotów za gorących lub bardzo zimnych.
- Nie uderzać twardymi przedmiotami w szklane powierzchnie i krawędzie.
- Na szklanych powierzchniach nie wolno siadać, stawać i opierać się.

- Produkt nie służy do zabawy! Dzieci nie powinny bawić się opakowaniem produktu, gdyż mogą się udusić się folią lub skaleczyć opakowaniem.
- Należy dopilnować, aby dzieci nie bawiły się lub też brały do ust żadnych drobnych części mebla, takich jak np. nakrętki, zatyczki itp. Mogłyby je połknąć i udusić się nimi.
- Bezpieczne użytkowanie przedmiotu można zagwarantować tylko wtedy, gdy wszystkie części są prawidłowo zablokowane.
- Prosimy po ok. 5 tygodniach dokręcić wszystkie śruby i elementy łączeniowe. Zagwarantuje to Państwu trwałość i stabilność połączeń.

CZ

- Vždy se řiďte pokyny výrobce.
- Výměnu plynových pružin, popř. práci na nich smí provádět jen zaškolení specialisté.
- Postarejte se o to, aby se skleněné plochy nacházely v dostatečné vzdálenosti od horkých nebo velmi studených předmětů.
- Nenarážejte tvrdými předměty do skleněných ploch nebo hran.
- Na skleněné plochy si nikdy nesedejte, nestoupejte na ně ani se o ně neopírejte.
- Výrobek není hračkou pro děti! Nenechávejte děti ani hrát si s obalem. Mohly by se udusit fólií nebo se poranit o přebal.
- Dbejte na to, aby děti nedávaly do úst žádné drobné díly jako např. matice, krytky a podobně. Mohly by je spolknout a udusit se.
- Bezpečné používání výrobku může být zaručeno jen tehdy, pokud jsou všechny jeho části řádně zajištěny.
- Dotáhněte všechny šrouby a nosné spojovací díly přibližně po 5 týdnech, aby se zaručila trvalá stabilita.

SK

- Vždy dodržiavajte pokyny výrobcu.
- Výmenu pneumatickej pružiny, príp. práce na nej, smie vykonať len vyškolený odborný personál.
- Postarajte sa, aby sklené plochy boli v dostatočnej vzdialenosti od horúcich alebo veľmi studených predmetov.

- Nendarazte s tvrdými predmetmi na sklené plochy alebo hrany.
- Nikdy si nesadnite, nepostavte sa alebo sa neoprite na sklené plochy.
- Tento výrobok nie je žiadnou hračkou pre deti! Nedovoľte deťom, aby sa hrali s obalovou fóliou. Mohli by sa s fóliou zadusiť alebo sa na vrchnom obale poraniť.
- Dbajte, aby si deti nemohli dať do úst drobné diely, ako napr. matice, krytky alebo podobne. Mohli by ich prehltnúť a zadusiť sa.
- Bezpečné používanie výrobku je možné zaručiť iba vtedy, ak sú všetky časti správne zaaretované.
- Po cca 5 týždňoch dotiahnite skrutky, aby bola zaručená ich trvalá stabilita.

HU

- Kövesse a gyártó utasításait.
- A gáزرúgót kizárólag képzett szakember cserélheti és javíthatja.
- Biztosítson megfelelő távolságot az üvegfelületek és a túl meleg vagy túl hideg tárgyak között.
- Védje az üvegfelületeket és azok éleit az ütődésektől.
- Soha ne üljön, álljon, támaszkodjon az üvegfelületre.
- A termék nem gyermekek számára készült játékszer! Ne hagyja a gyermekeket a csomagolófóliával játszani. A fóliába tekeredve megfulladhatnak vagy sérülést szenvedhetnek.
- Gondoskodjon arról, hogy a gyerekek ne vehessék a szájukba a kis alkatrészeket, pl. az anyákat, a fedőkupakokat stb. Ezeket lenyelve megfulladhatnak.
- A termék biztonságos használata csak az összes alkatrész szabályszerű rögzítése esetén szavatolható.
- Húzza utána – kb. 5 hét múlva – az összes csavart és a teherhordó összekötő alkatrészeket a biztonság érdekében.

RO

- Urmați instrucțiunile producătorului.
- Înlocuirea arcurilor comprimate cu gaz sub presiune, respectiv toate lucrările aferente, se efectuează numai de către personal de specialitate instruit.

- Asigurați suprafețelor din sticlă o distanță suficientă față de obiectele prea fierbinți sau foarte reci.
- Evitați impactul suprafețelor sau a marginilor din sticlă cu obiecte dure.
- Nu vă așezați și nu vă sprijiniți niciodată pe suprafețele din sticlă.
- Produsul nu constituie un obiect de joacă pentru copii! Nu lăsați copiii să se joace cu folia ambalajului. Există pericolul de asfixiere cu folia sau de rănire cu ambalajul.
- Supravegheați copiii pentru că pot să introducă în gură piesele mici, cum ar fi de exemplu piulițe, capace sau altele similare. Ei pot să le înghită și se pot asfixia.
- Doar dacă toate piesele componente sunt blocate în mod corespunzător, se poate garanta utilizarea în siguranță a articolului.
- Pentru a asigura o stabilitate de durată, strângeți după cca. 5 săptămâni toate șuruburile, precum și toate elementele portante de legătură.

TR

- Daima üreticinin talimatlarına uyunuz.
- Gazlı basınç yayının değiştirilmesi veya onunla ilgili çalışmalar yalnızca bu konuda eğitim almış uzman personel tarafından yapılmalıdır.
- Cam yüzeylerin çok soğuk veya çok sıcak nesnelere yeteri kadar uzakta olmasına dikkat ediniz.
- Cam yüzeylere veya cam kenarlara sert cisimlerle temas etmemeye dikkat ediniz.
- Asla cam yüzeylerinin üzerine çıkmayınız, üzerine oturmayınız ve onlardan destek almayınız.
- Bu ürün bir çocuk oyuncakı değildir! Çocukların ürün ambalajlarıyla oynamalarına asla müsaade etmeyiniz. Çocuklar, folyo nedeniyle boğulabilir veya ambalaj nedeniyle yaralanabilirler.
- Çocukların somun, muhafaza kapakçıkları ve benzeri küçük parçaları ağızlarına almamalarına dikkat ediniz. Bunları yutabilirler ve boğulabilirler.
- Ancak tüm parçalar usulüne uygun bir şekilde yerine oturduğunda ürünün güvenli bir şekilde kullanımı garanti edilebilir.
- Tüm vida ve taşıyıcı bağlantı parçalarını kalıcı bir duruş güvenliğini sağlamak için yaklaşık 5 hafta sonra tekrar sıkınız.

RU

- Строго соблюдайте инструкции производителя.
- Замену газовой пружины и работы над ней должен осуществлять квалифицированный персонал, прошедший соответствующий инструктаж.
- Стеклопакетные поверхности должны находиться на достаточном расстоянии от горячих или слишком холодных предметов.
- Не допускайте ударов твердыми предметами по стеклянным поверхностям или по их краям.
- Никогда не садитесь, не становитесь и не опирайтесь на стеклянные поверхности.
- Не допускается игра детей с изделием! Не разрешайте детям играть с упаковочным материалом. Дети могут задохнуться в упаковочной пленке или пораниться упаковочным материалом.
- Следите, чтобы мелкие детали, например гайки, крышки и т. п., не попали в рот ребенка. Дети могут их проглотить и задохнуться.
- Использование изделия может быть безопасным только в том случае, если все его элементы зафиксированы надлежащим образом.
- Подкрутите все болты, а также несущие соединительные детали прибл. через 5 недель для обеспечения устойчивости в течение длительного времени.

**D: WICHTIG, FÜR SPÄTERE BEZUGNAHME
DIESES DOKUMENT AUFBEWAHREN!
SORGFÄLTIG LESEN!**

Dieses Außenmöbel ist nur zur Verwendung im privaten Wohnbereich vorgesehen.

**GB: IMPORTANT, HOLD ON TO THIS DOCUMENT
FOR LATER REFERENCE! READ CAREFULLY!**

This outdoor furniture is only intended for use in private residential areas.

**FR: IMPORTANT, CONSERVER CE DOCUMENT
POUR VOUS Y RÉFÉRER ULTÉRIEUREMENT! LE
LIRE ATTENTIVEMENT!**

Ce meuble d'extérieur n'est prévu que pour une utilisation dans le domaine privé.

**IT: IMPORTANTE, CONSERVARE LE PRESENTI
ISTRUZIONI PER OGNI ULTERIORE
CONSULTAZIONE! LEGGERE CON ATTENZIONE!**

Il presente mobile da esterno è previsto solo per l'uso in ambito domestico.

**NL: BELANGRIJK, BEWAAR DIT DOCUMENT ALS
REFERENTIE IN DE TOEKOMST!**

ZORGVULDIG LEZEN! Dit buitenmeubel is alleen bedoeld voor het gebruik in
privéwoningen.

**PL: WAŻNE, DOKUMENT PRZECHOWAĆ NA
PRZYSZŁOŚĆ JAKO MATERIAŁ REFERENCYJNY!
DOKŁADNIE PRZECZYTAĆ!**

Ten mebel zewnętrzny jest przewidziany jedynie do użytku w prywatnych strefach
mieszkalnych.

**RO: IMPORTANT! PĂSTRĂȚI ACEST DOCUMENT
PENTRU CONSULTAREA ULTERIOARĂ! CITITI CU
ATENTIE!**

Acest mobilier de exterior este destinat doar utilizării în zonele de locuit private.

**RU: ВАЖНО СОХРАНИТЬ ЭТОТ ДОКУМЕНТ ДЛЯ ИСПОЛЬЗОВАНИЯ В ДАЛЬНЕЙШЕМ!
ВНИМАТЕЛЬНО ОЗНАКОМЬТЕСЬ С НИМ!**

Этот предмет уличной мебели предназначен только для использования в частных жилых зонах.

SK: DÔLEŽITÉ, USCHOVAJTE SI TENTO DOKUMENT PRE BUDÚCE POUŽITIE! ČÍTAJTE POZORNE!

Tento vonkajší nábytok je určený len na použitie v súkromnom obytnom priestore.

CZ: DŮLEŽITÉ! TENTO DOKUMENT SI USCHOVEJTE PRO POZDĚJŠÍ POUŽITÍ. ČTĚTE POZORNĚ!

Tento venkovní nábytek je určený pouze k použití v soukromém obytném prostoru.

**HU: FONTOS – KÉSŐBBI FELHASZNÁLÁSRA ŐRIZZE MEG EZT A DOKUMENTUMOT!
GONDOSAN OLVASSA EL!**

Ez a kültéri bútor csak magán lakóterületen történő használatra szolgál.

TR: ÖNEMLİ, DAHA SONRA FAYDALANMAK İÇİN BU DOKÜMANI SAKLAYIN! DİKKATLİCE OKUYUN!

Bu dış mekan mobilyası sadece özel oturma alanında kullanılması için tasarlanmıştır.

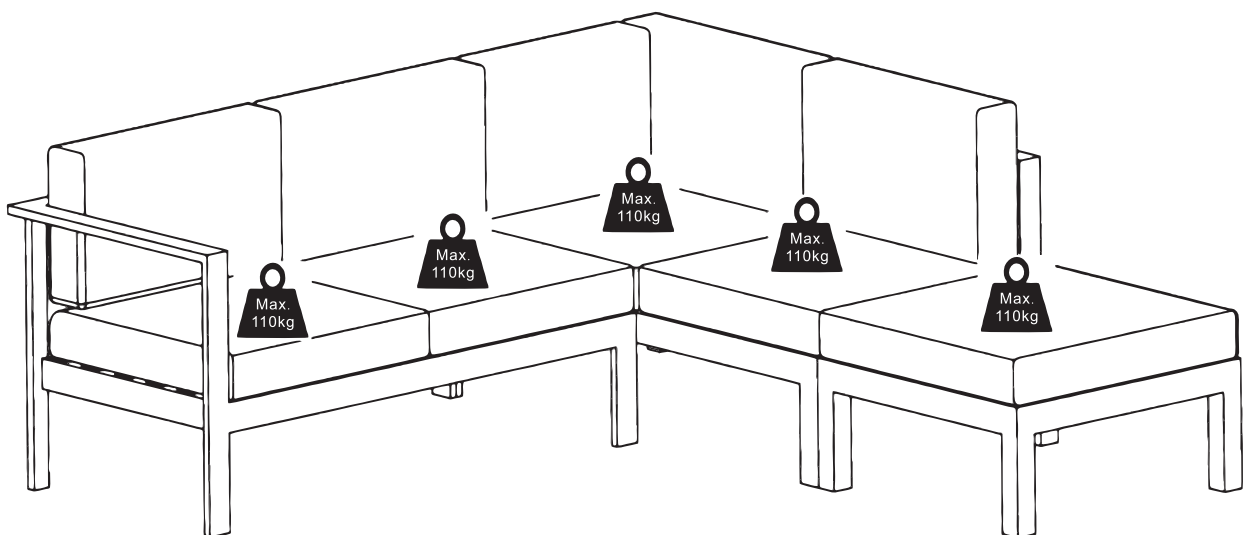

0
10
20
30
40
50
60
70
80
90
100
110
120
130
140
150
160
170
180
190
200

**Service • Assistenza • Dienstverlening • Serwis Servis • Szerviz •
Сервисная служба**

Name • Nom • Nome • Naam • Nazwa • Jméno • Názov • Név • Denumire • Ísim • Название	Belluno
Nr. • No. • N° • Номер • Č • Sz	98290242,93313252
Typ • Type • Tip • Típus • Тиро • Тип	

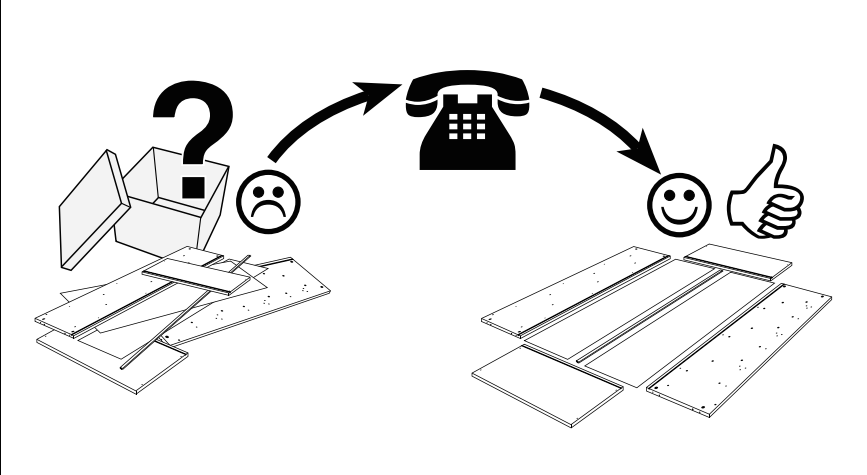
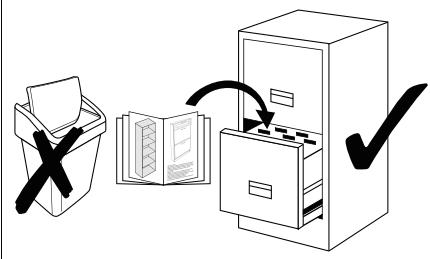

AproductZ GmbH
Werner-Otto-Straße 1-7, 22179 Hamburg, Germany

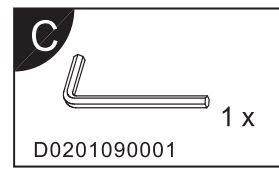
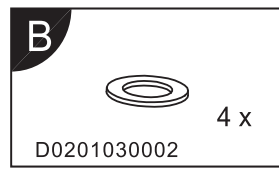
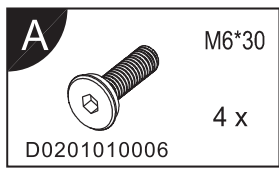
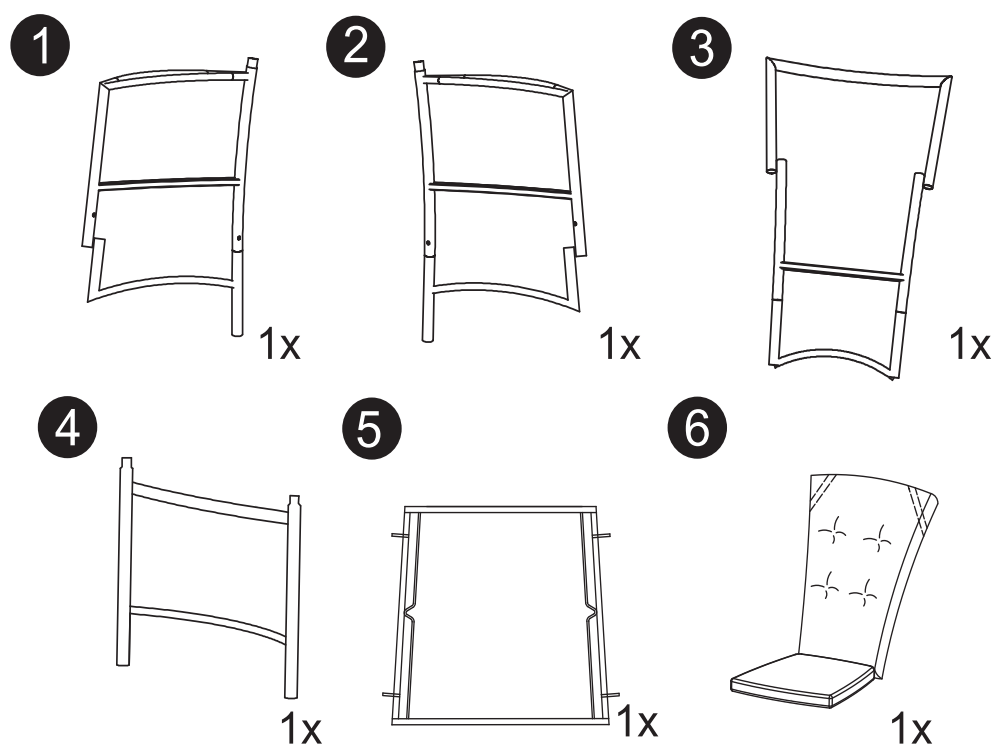

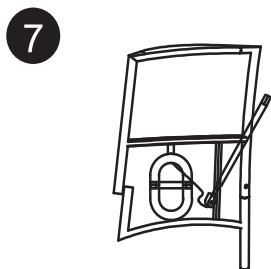

1x

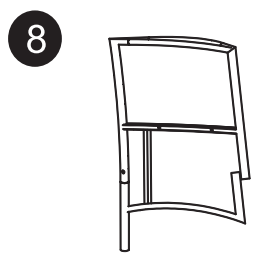

1x

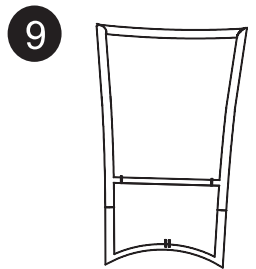

1x

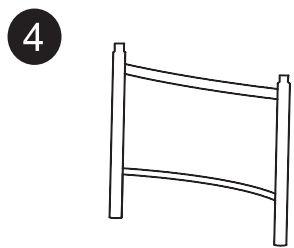

1x

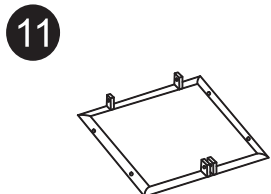

1x

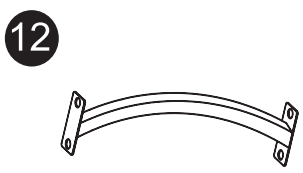

1x

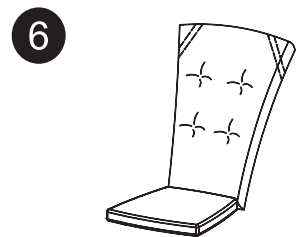

1x

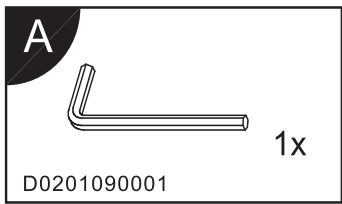

D0201090001

1x

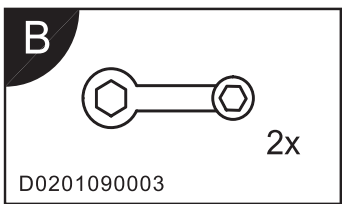

D0201090003

2x

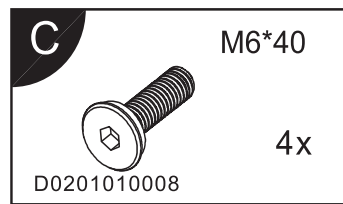

D0201010008

M6*40

4x

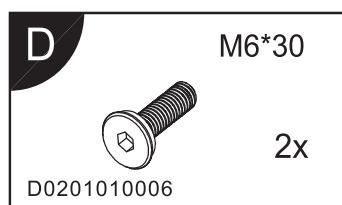

D0201010006

M6*30

2x

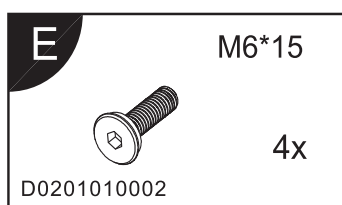

D0201010002

M6*15

4x

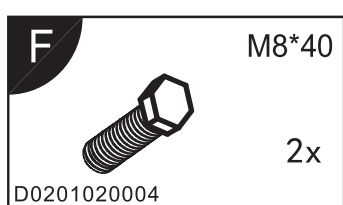

D0201020004

M8*40

2x

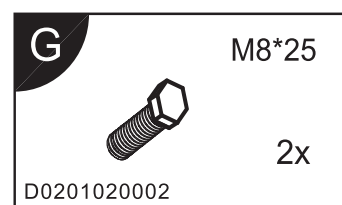

D0201020002

M8*25

2x

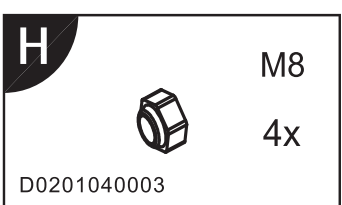

D0201040003

M8

4x

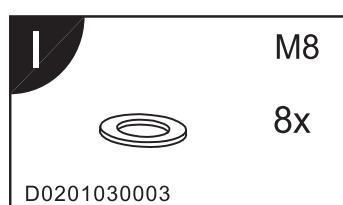

D0201030003

M8

8x

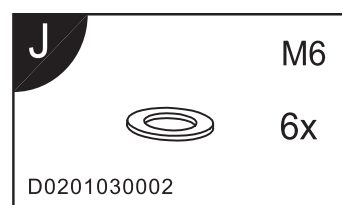

D0201030002

M6

6x

14

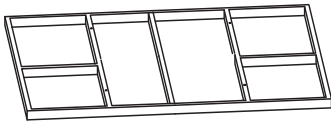

1x

15

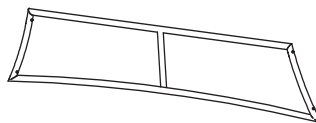

2x

16

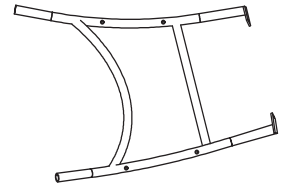

2x

17

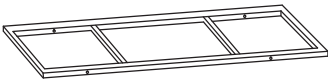

1x

18

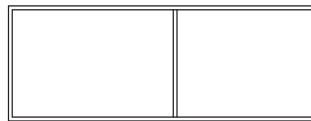

1x

19

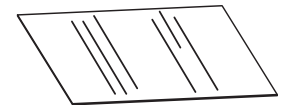

1x

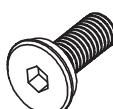
A M6*15

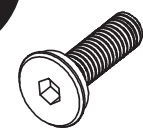
 4x
 D0201010002

B M6*35

 12x
 D0201010007

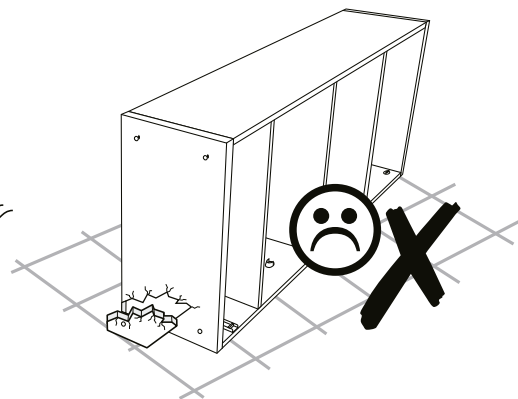
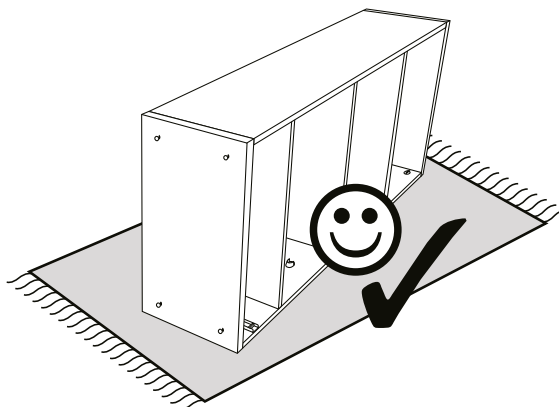
C

 16x
 D0201090001

D

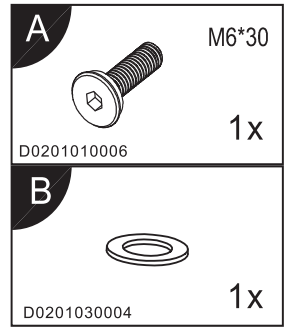
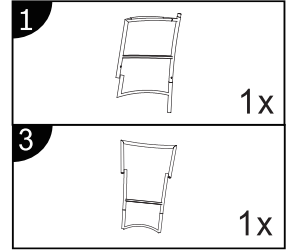
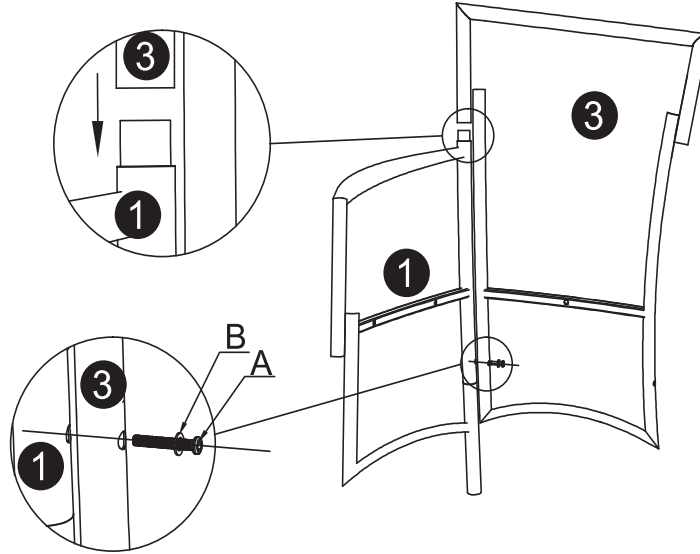
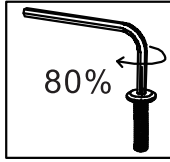
 1x
 D0201030004



1

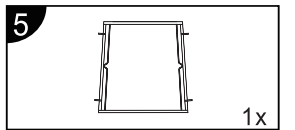
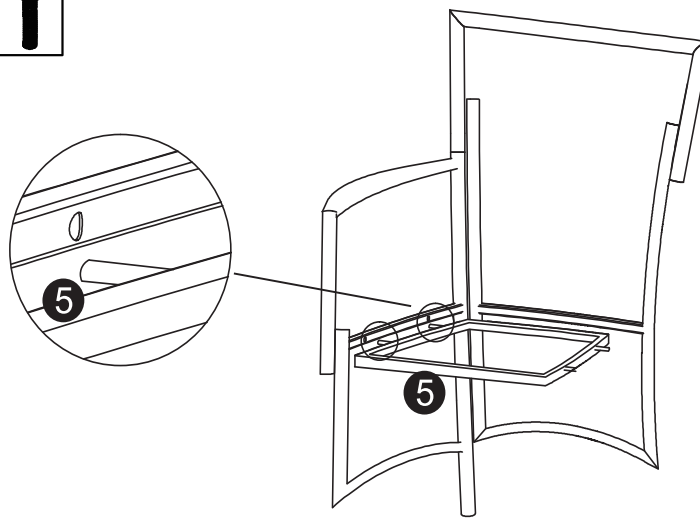
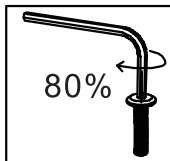

2



3

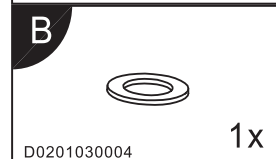
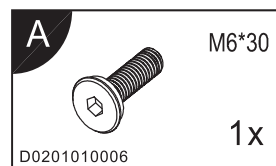
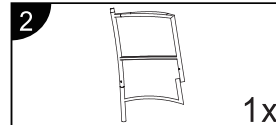
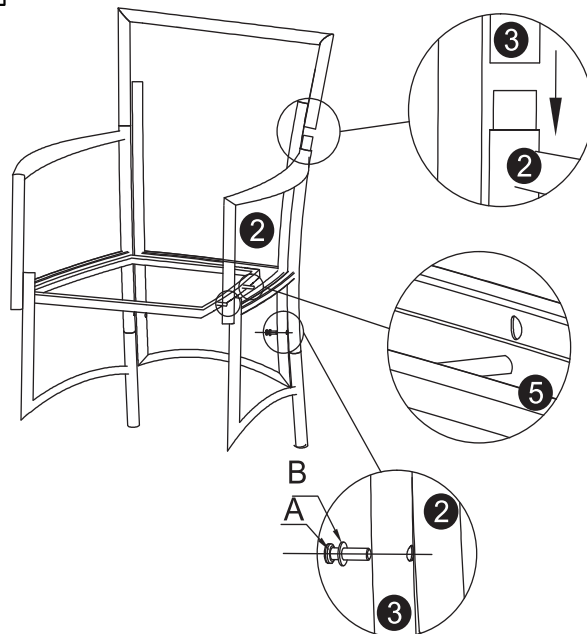
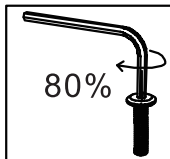

4

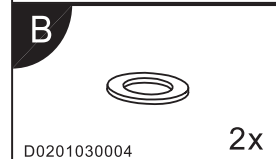
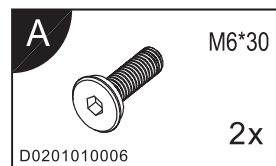
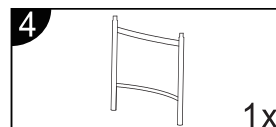
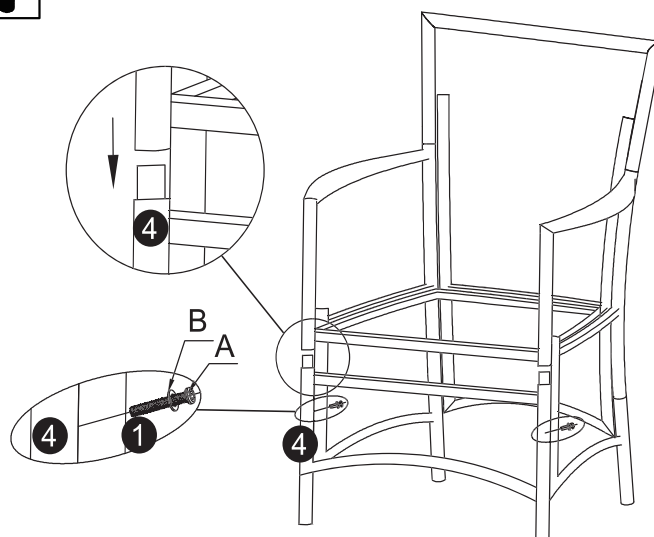
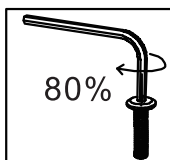

5

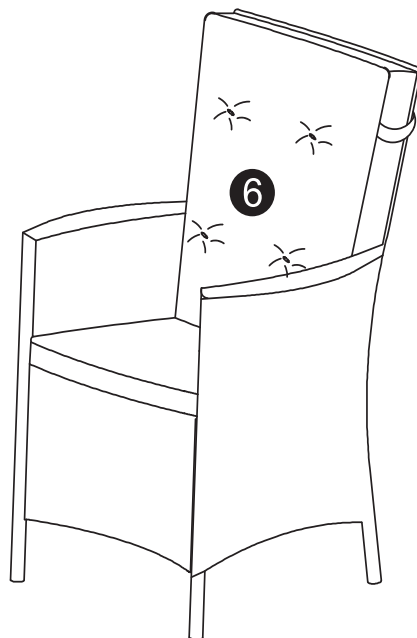
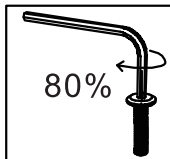

6

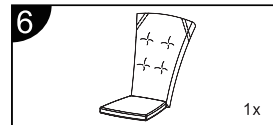

6

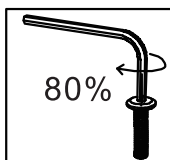

X2

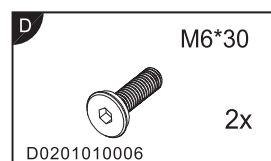
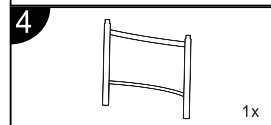
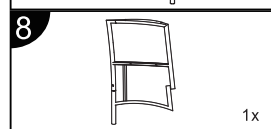
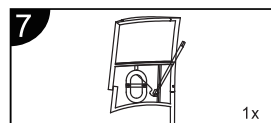
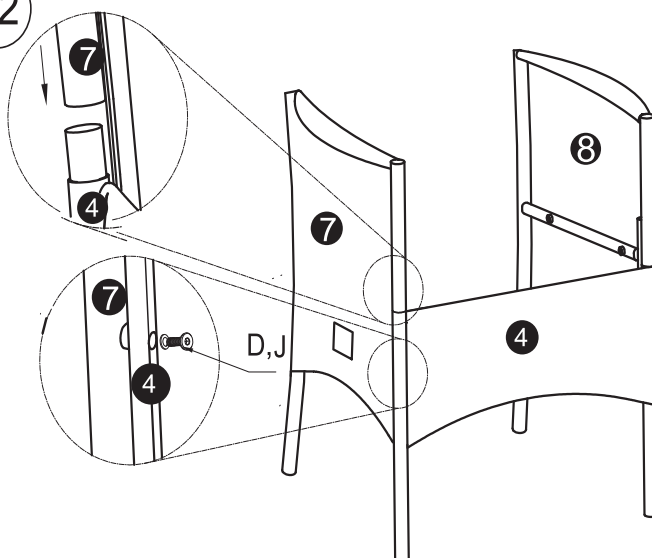

7

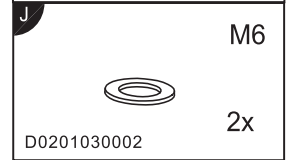
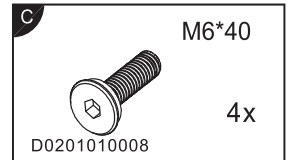
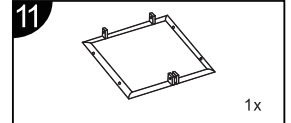
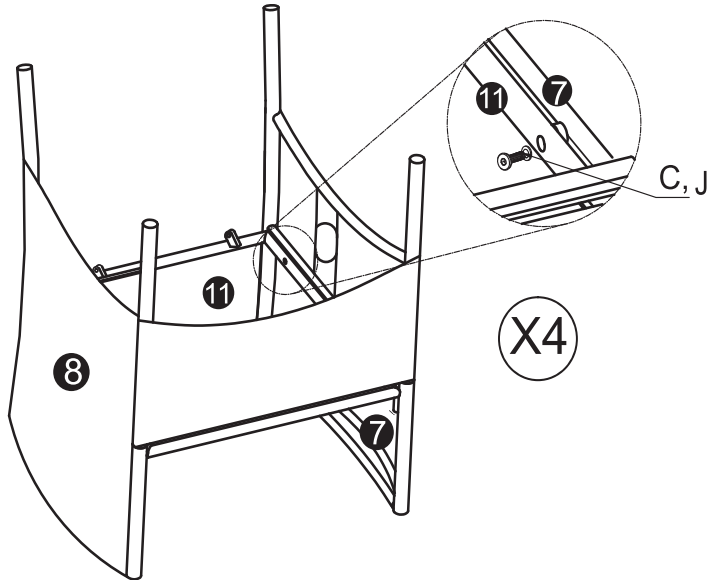
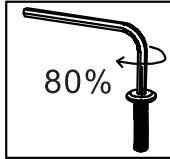

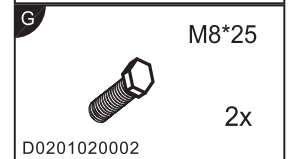
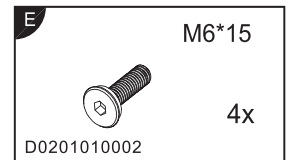
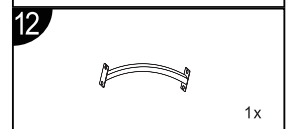
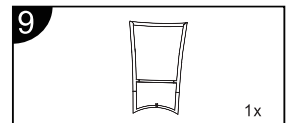
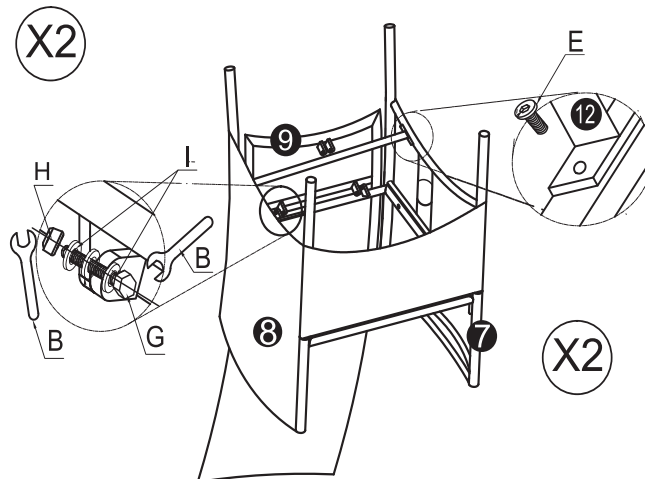
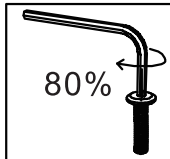

8

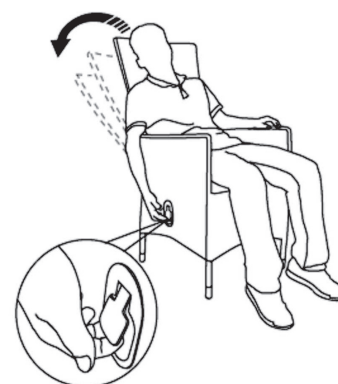
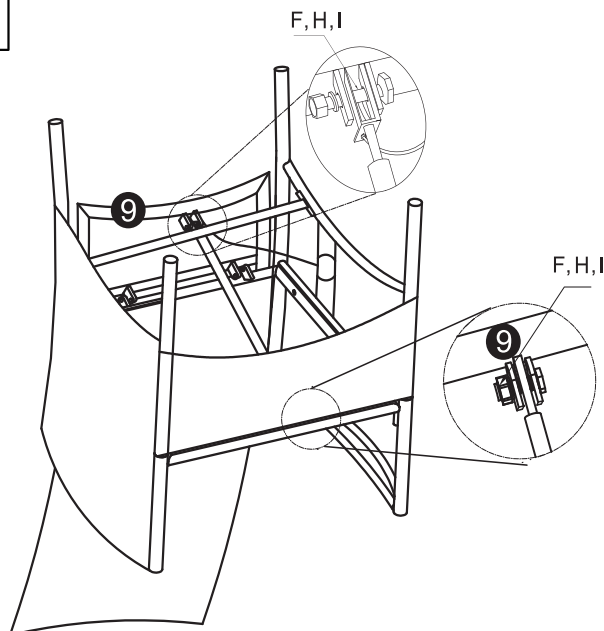
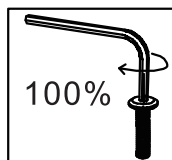

9



F	M8*40
	2x
D0201020004	
H	M8
	4x
D0201040003	

DE	Um Verletzungen und Quetschungen zu vermeiden, verstellen, falten, öffnen oder schließen Sie den Artikel vorsichtig.
GB	To avoid injury and crushing, adjust, fold, open or close the item carefully.
FR	Ajustez, pliez, ouvrez ou fermez l'article avec précaution afin d'éviter les blessures et les écrasements.
IT	Per evitare lesioni e schiacciamenti, regolare, piegare, aprire o chiudere l'articolo con cautela.
NL	Om letsel en kneuzingen te voorkomen, moet u het artikel voorzichtig verstellen, vouwen, openen of sluiten.
PL	Aby uniknąć obrażeń ciała i zgniecenia, należy podczas przestawiania, składania, otwierania lub zamykania produktu zachować ostrożność.
CZ	Abyste předešli zranění a pohmoždění prstů, přemísťujte, skládejte, otevírejte nebo zavírejte výrobek opatrně.
SK	Aby ste predišli zraneniam a pomliaždeniam, výrobok prestavujte, skladajte, otvárajte alebo zatvárajte opatrne.
HU	A sérülések és zúzódások megelőzése érdekében óvatosan állítsa be, hajtsa össze, nyissa ki vagy zárja le a terméket.
RO	Pentru a evita rănirea și strivirea, reglați, pliați, deschideți sau închideți articolul cu atenție.
TR	Yaralanmaları ve ezilmeleri önlemek için dikkatli bir şekilde ürünün yerini değiştirin, katlayın, açın veya kapatın.
RU	Во избежание получения травм, в том числе защемлений, следует соблюдать меры предосторожности при перемещении, складывании, открывании или закрывании изделия.

10

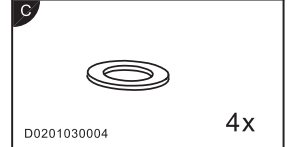
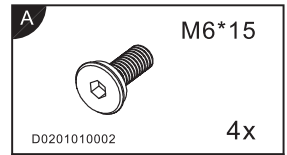
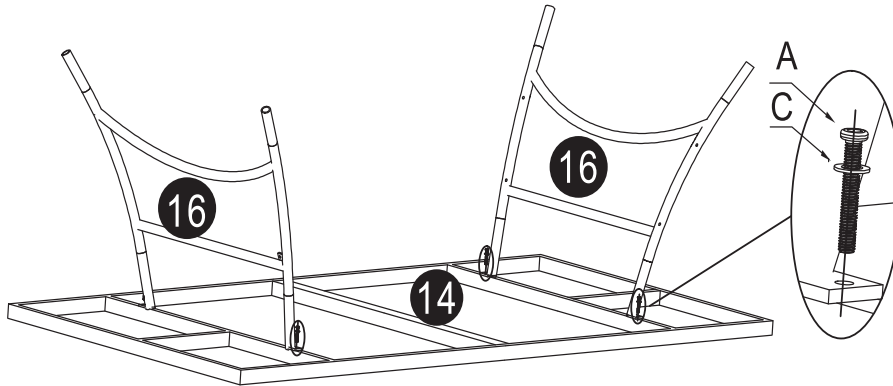
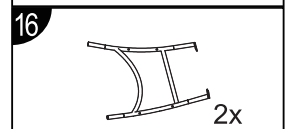
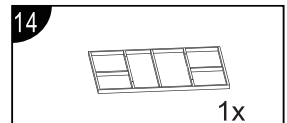
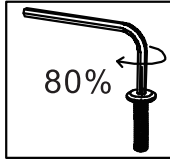

11

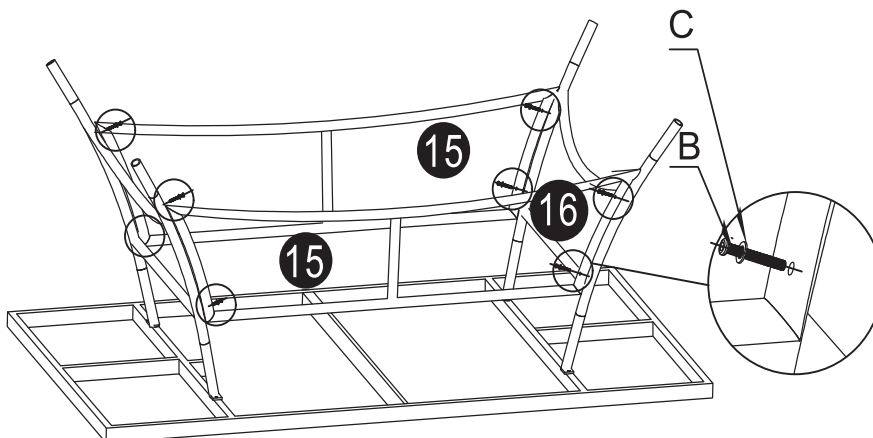
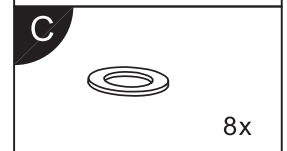
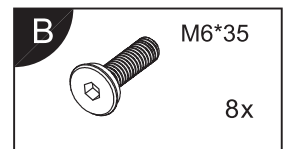
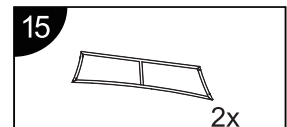
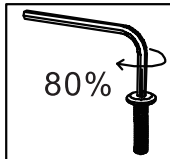

12

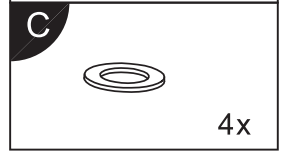
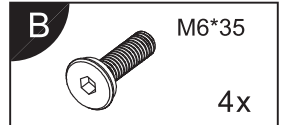
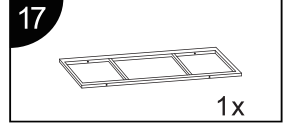
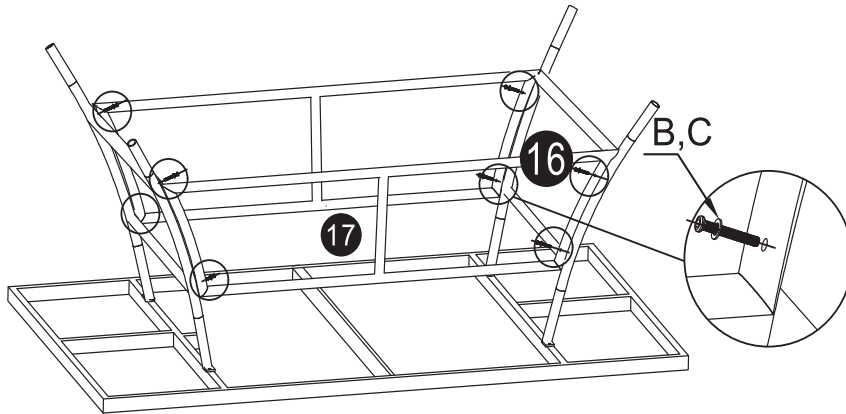
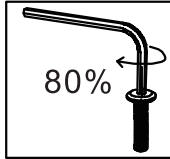

13

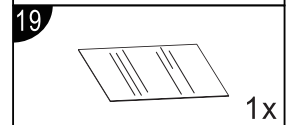
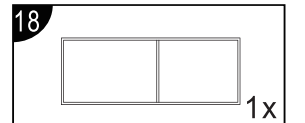
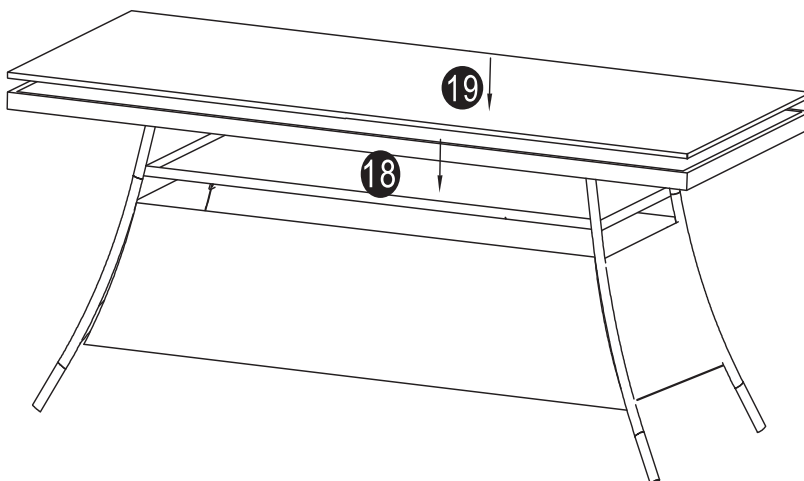
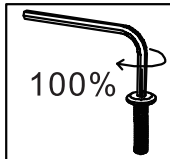

14

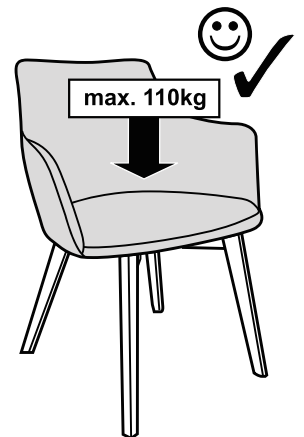
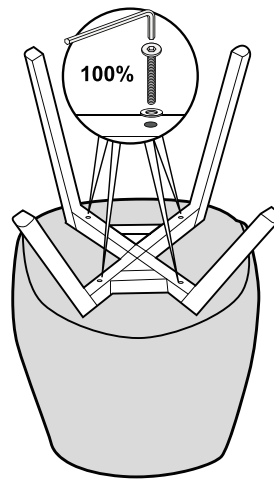
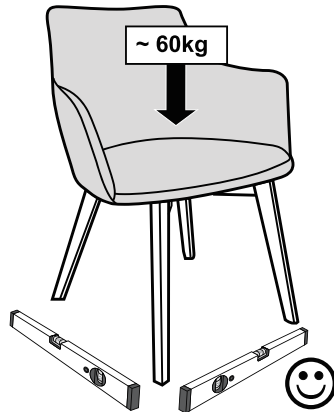
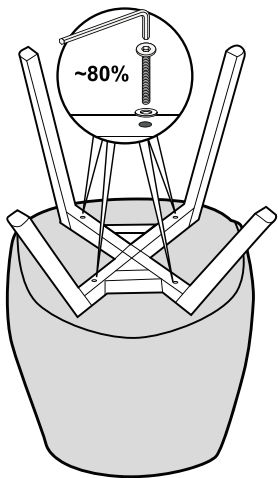
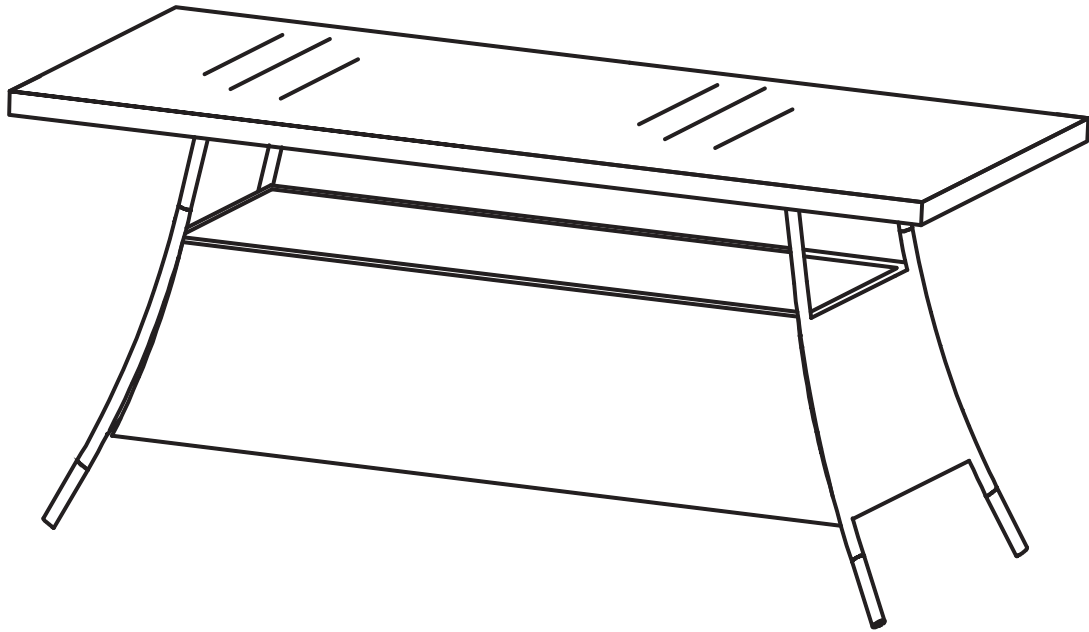

Colli 1:

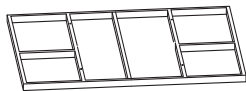

1x

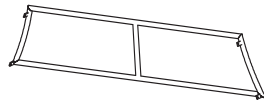

2x

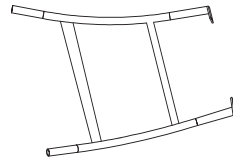

2x

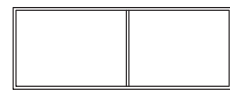

1x

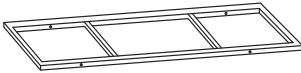

1x

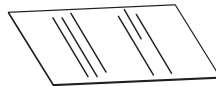

1x

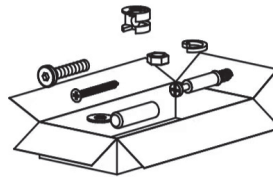

Colli 2:

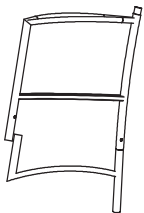

4x

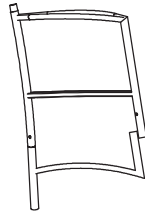

4x

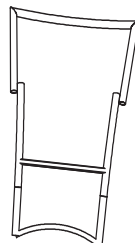

4x

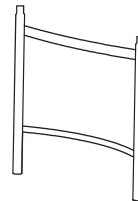

4x

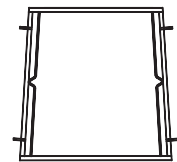

4x

Colli 3:

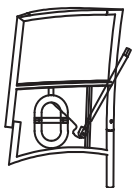

2x

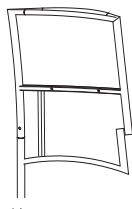

2x

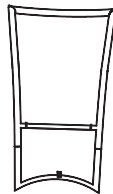

2x

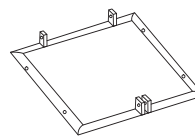

2x

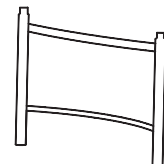

2x



2x

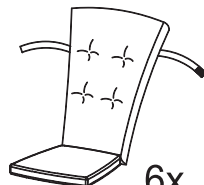

6x

