

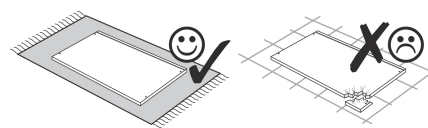

87259.350

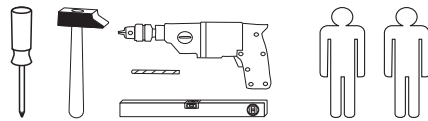

1 10 x 2827	2 10 x	3 8 x 30 22 x 2861	4 6,3 x 11 30 x 2815	5 4 x
6 2 x	7 4 x 45 1 x 2814	8 6 x 34 1 x 2844	9 1 x 2845	10 3,5 x 15 41 x 2804
11 4 x 9 2 x	12 5 x 30 1 x	13 Leim 1 x 2863	14 5 x R 5283.500	15 5 x L 5283.500
16 4 x 2865	17 3 x 13,5 20 x 1123	18 5mm 4 x 2855	19 4 x 15 1 x 2810	

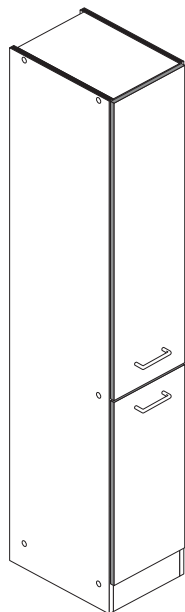
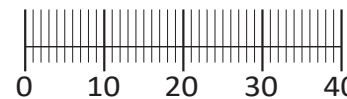

Das beigefügte Wandbefestigungsmaterial (Dübel und Schrauben) eignet sich nur für festes Mauerwerk (z.B.: Beton- oder Ziegelwände). Für andere Wandaufbauten sind eventuell Spezialdübel und andere Schrauben notwendig. Ziehen Sie gegebenenfalls eine Fachkraft zu Rate.

De begeleidende wandmontage hardware (pluggen en schroeven) is alleen geschikt voor massief metselwerk (bijvoorbeeld beton of bakstenen muren). Voor andere muur structuren zijn eventueel bijzondere ankerbouten en andere noodzakelijke. Draai indien nodig, een deskundige.

Приложенный материал для крепления к стене (дюбели и винты) пригоден только для жестких кладок (например, бетонные или кирпичные стены). Для других настенных конструкций необходимы смотря по обстоятельствам специальные дюбели и другие винты. При необходимости проконсультируйтесь у специалиста.

Le mur d'accompagnement matériel de montage (chevilles et les vis) ne convient que pour la maçonnerie solide (par exemple en béton ou des murs de briques). Pour les structures de mur d'autres sont peut-être spéciale boulons d'ancrage et d'autres nécessaires. Serrer le cas échéant, un expert.

Załączony materiał do mocowania do ściany (kolki rozprężne i wkręty) nadaje się tylko do ścian murowanych (np. z betonu lub cegiel). Do ścian wykonanych w innych technologiach konieczne być mogą specjalne kolki rozprężne i inne wkręty. W razie potrzeby skorzystaj z fachowej pomocy

Il muro di accompagnamento hardware di montaggio (tasselli e viti) è'e adatto solo per muratura piena (ad esempio calcestruzzo o muratura). Per le altre strutture murarie sono forse speciali bulloni di ancoraggio e necessari di altri. Serrare se necessario, un esperto.

The accompanying wall mounting hardware (anchors and screws) is suitable only for solid masonry (eg concrete or brick walls). For other wall structures are possibly special anchor bolts and other necessary. Tighten if necessary, an expert.

Ekteki duvarlar sabit montaj malzemeleri (dübel ve vidalar), sadece sağlam duvarlar için (örnek: beton veya tuğla) elverişlidir. Başka duvarlar için özel dübeller ve farklı vidalar gerekebilir. Gerekliğinde bir uzmana danışınız.

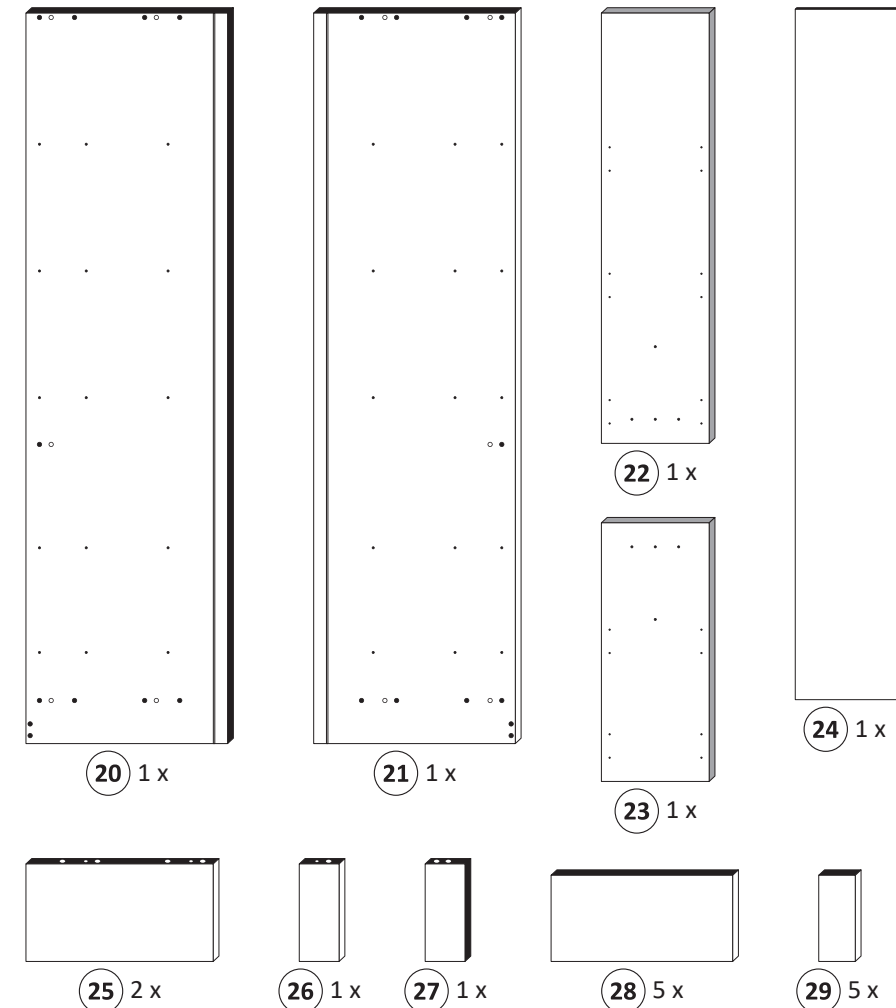

1

4 6,3 x 11 30 x 2815	15 5 x R 5283.500	15 5 x L 5283.500
----------------------------	-------------------------	-------------------------

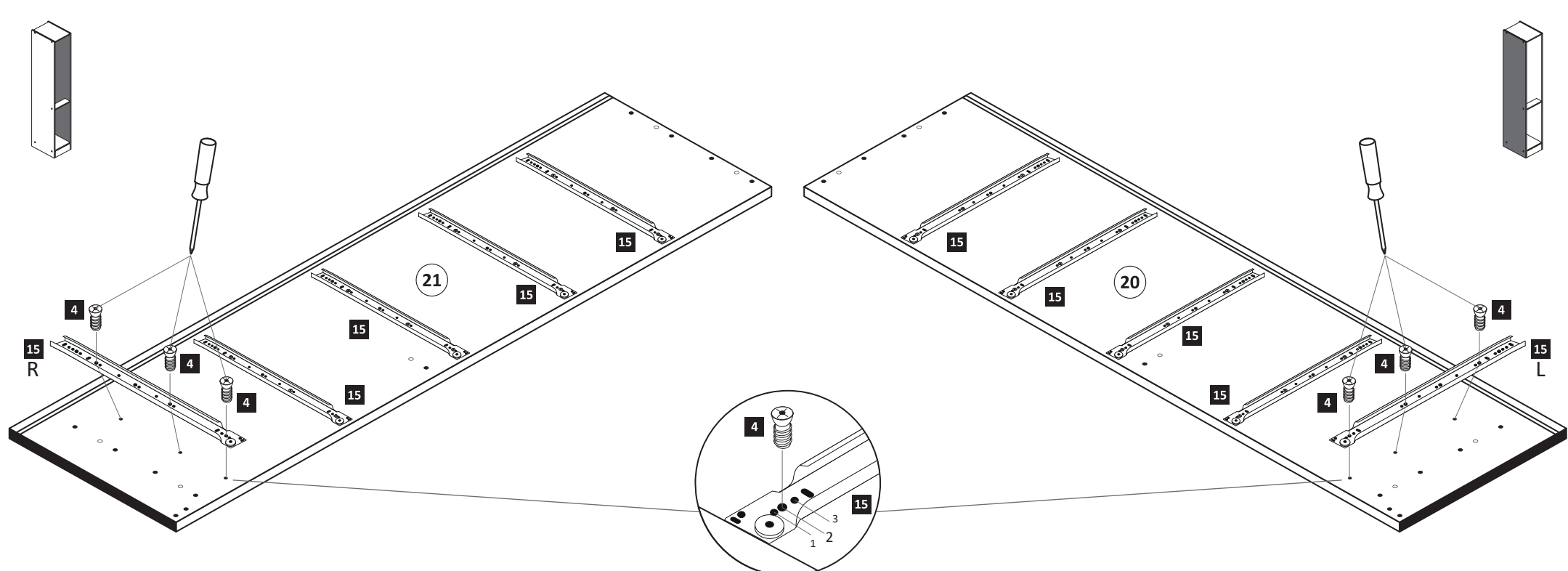

2

3 8 x 30 22 x 2861	13 Leim 1 x 2863
--------------------------	------------------------

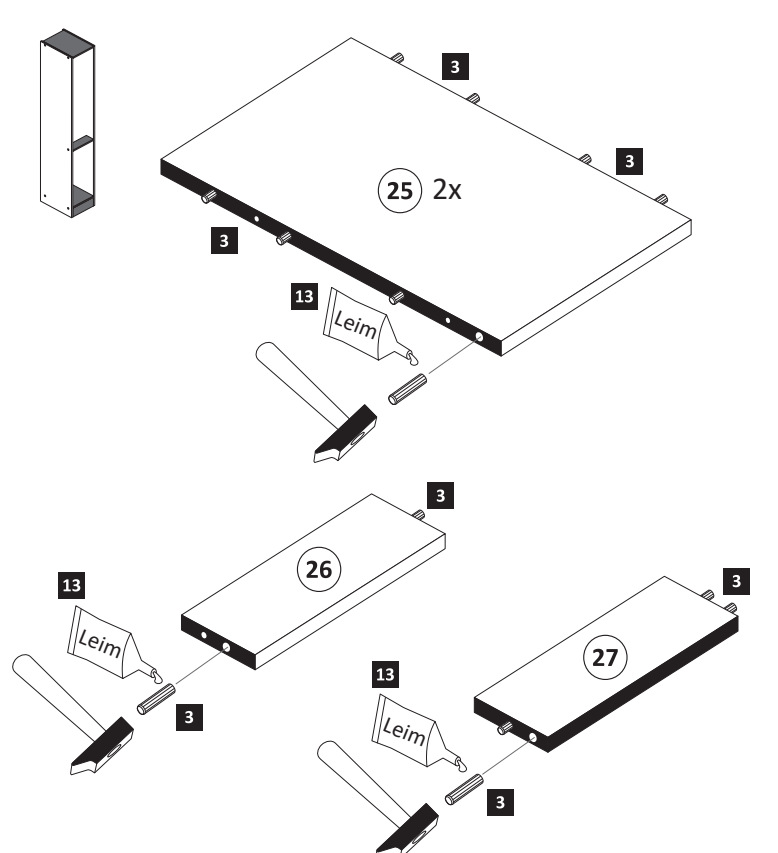



**D****Wichtige Pflegehinweise**

Bitte beachten Sie die wichtigen Pflegehinweise auf unserer Internetseite

[www.till-hilft.de](http://www.till-hilft.de)

Pflegehinweise

**PL****Ważne instrukcje dotyczące pielęgnacji**

Zwróć uwagę na ważną instrukcję dotyczącą pielęgnacji na naszej stronie internetowej

[www.till-hilft.de](http://www.till-hilft.de)

Pflegehinweise

**GB****Important care instructions**

Please note the important care instructions on our website

[www.till-hilft.de](http://www.till-hilft.de)

Pflegehinweise

**SK****Dôležité pokyny na starostlivosť**

Dbajte na dôležité pokyny týkajúce sa starostlivosti na našich webových stránkach

[www.till-hilft.de](http://www.till-hilft.de)

Pflegehinweise

**FR****Instructions d'entretien importantes**

S'il vous plaît noter les instructions de soins importants sur notre site Web

[www.till-hilft.de](http://www.till-hilft.de)

Pflegehinweise

**HU****Fontos kezelési utasítások**

Kérjük, vegye figyelembe a honlapunkon található fontos kezelési útmutatót

[www.till-hilft.de](http://www.till-hilft.de)

Pflegehinweise

**IT****Importanti istruzioni per la cura**

Si prega di notare le importanti istruzioni per la cura sul nostro sito web

[www.till-hilft.de](http://www.till-hilft.de)

Pflegehinweise

**RO****Instrucțiunile importante de îngrijire**

Rețineți instrucțiunile importante de îngrijire de pe site-ul nostru

[www.till-hilft.de](http://www.till-hilft.de)

Pflegehinweise

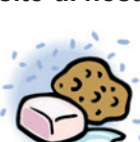
**NL****Belangrijke zorginstructies**

Let op de belangrijke zorginstructies op onze website

[www.till-hilft.de](http://www.till-hilft.de)

Pflegehinweise

**TR****Önemli bakım talimatları**

Lütfen web sitemizdeki önemli bakım talimatlarını dikkate alınız

[www.till-hilft.de](http://www.till-hilft.de)

Pflegehinweise

**CZ****Důležité pokyny pro péči**

Vezměte prosím na vědomí důležité pokyny pro péči na našich webových stránkách

[www.till-hilft.de](http://www.till-hilft.de)

Pflegehinweise

**RU****Важные инструкции по уходу**

Обратите внимание на важные инструкции по уходу на нашем веб-сайте

[www.till-hilft.de](http://www.till-hilft.de)

Pflegehinweise

