

Montageanleitung Kojenbett BONY	Mountinginstruction stapelbedden bed BONY
Mounting instructions Bunk bed BONY	Instructions d'utilisation de couchettes lit

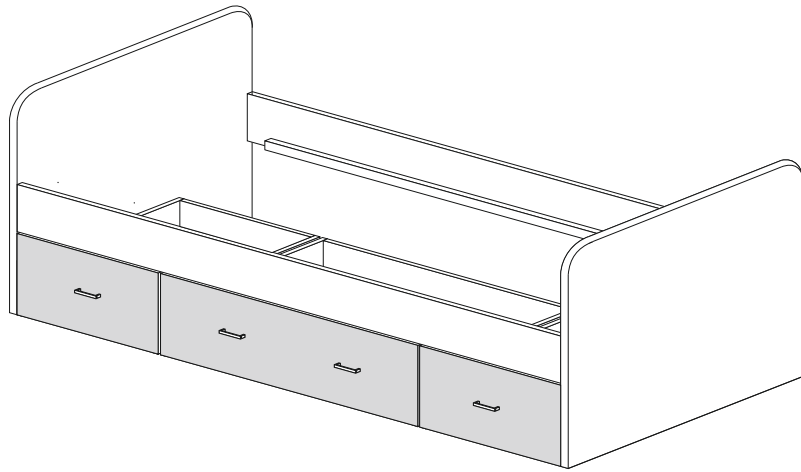

Notwendiger Hinweis: Important information: Belangrijke informatie: Information importante:

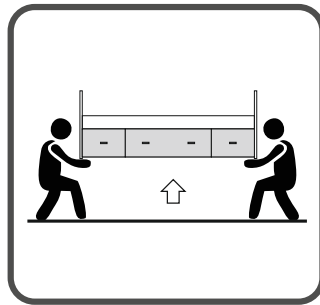
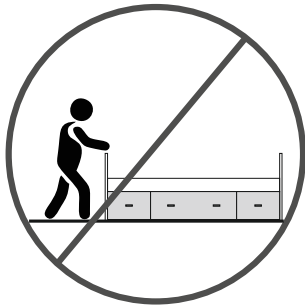

Bett nicht verschieben,
nur angehoben verstellen.

Move not only raises
bed adjusted

Bed niet verschuiven,
men moet het bed opheffen
om te verplaatsen

Ne pas pousser le lit,
il faut le porter pour déplacer

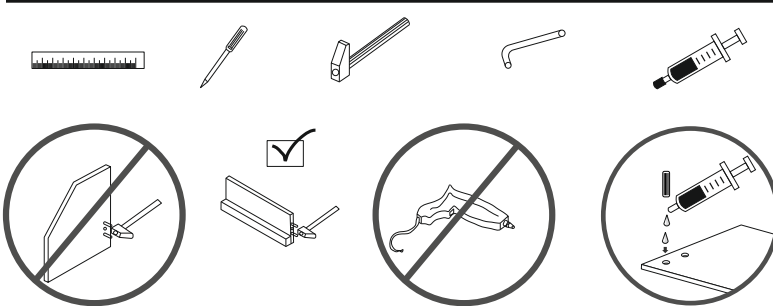
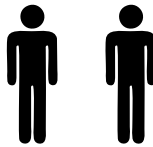













Anleitungen für die Montage

Instructions for the assembly

Instructies voor de montage

Instructions de montage

A	B	C	D	E	H	I	J	R
								
EURO SHTRAF x 14	∅ 4 x 20 /x 14	∅ 6 x 30 /x 32	∅ 4 x 16 /x 24	M 6 x 70 /x 8	M 4 x 20 /x 8	∅ 3 x 16 /x 8	glue /x 1	IMBUS x 1
K	L	M	N					
								
x 12	x 4	x 2	x 1					

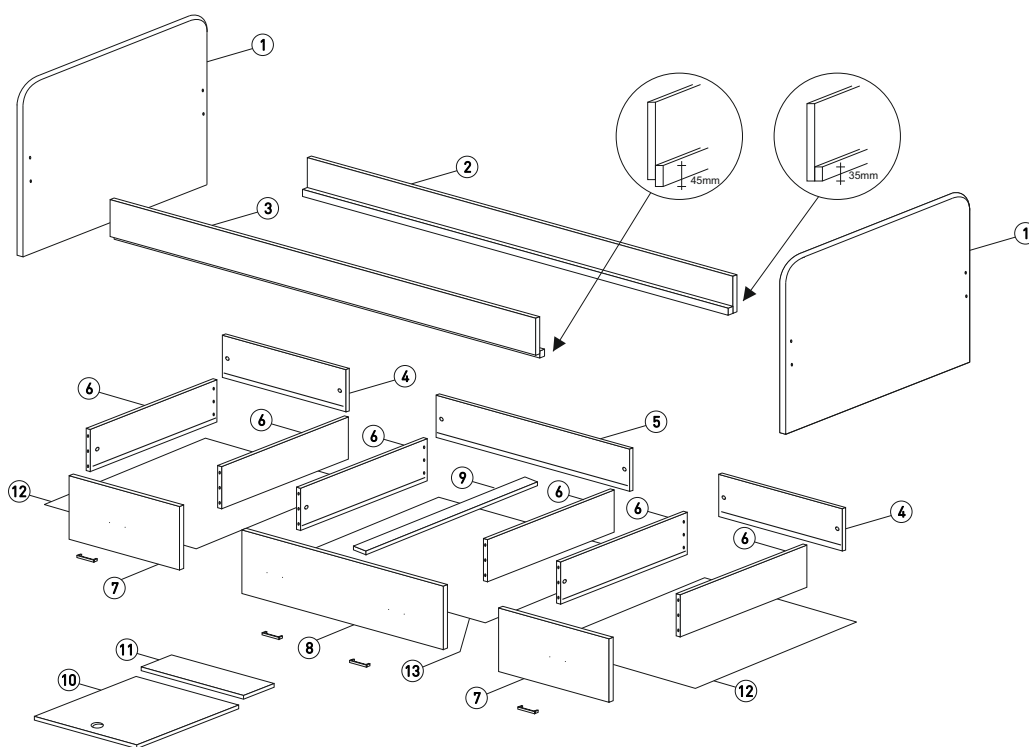
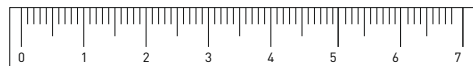

Ⓧ ACHTUNG bei einer Beanstandung !!
Um eine zügige Beanstandungsabwicklung zu gewährleisten, bitte bei Beschlägen den Buchstaben und die Menge angeben,
Beispiel: A M6x95
bei Möbelteilen die Zahl angeben
Beispiel: 1 1960x160x20

Ⓧ if you have a COMPLAINT !!
in order to enable us to deal with any complaints quickly, in the case fittings please state the letter and the quantity,
Example: A M6x95
For furniture items please state the number
Example: 1 1960x160x20

Ⓧ OPGELET bij een klacht !!
Om een vlotte klachtenafwerking te waarborgen, bij beslag de letters, het codenumber, en het aai,
bvb: A M6x95
bij meubeldelenhet kengetal aangeven
bvb: 1 1960x160x20

F ATTENTION en cas de réclamation !!
Pour assurer un traitement rapide des réclamations, veuillez indiquer, pour les ferrures, la lettre, le n,
Exemple: A M6x95
Pour les parties de meubles indiquer le nombre
Exemple: 1 1960x160x20



KOJENBETT BONY

1

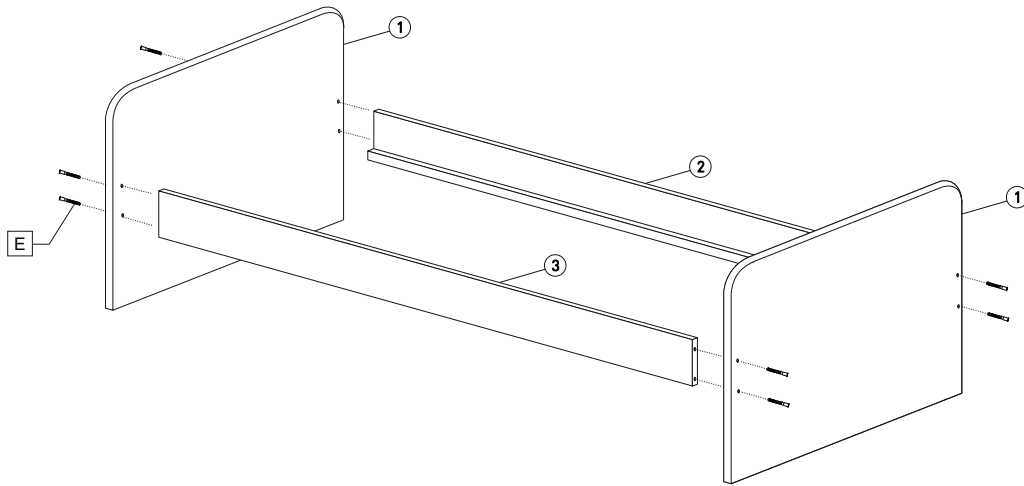
E  8 st.



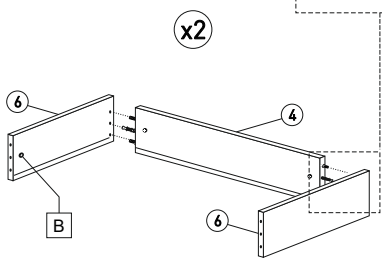
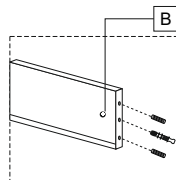

2

A  4 st.
C  8 st.
B  8 st.





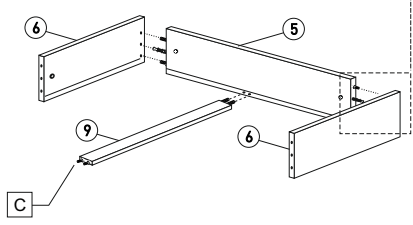
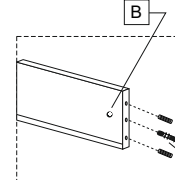

3

A  4 st.
C  8 st.
B  8 st.





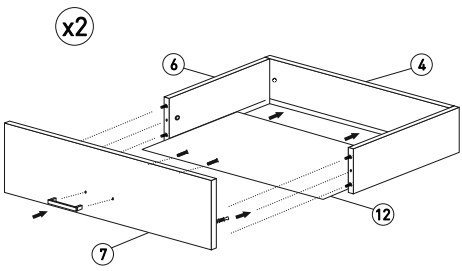

4

A  4 st.
C  8 st.
B  4 st.
H  4 st.
L  2 st.



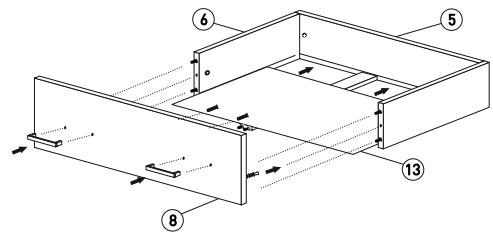

5

A  2 st.
C  4 st.
B  2 st.
H  4 st.
L  2 st.





KOJENBETT BONY

5

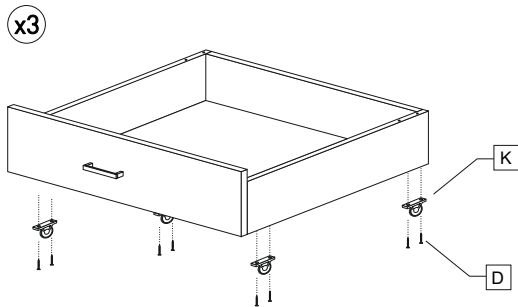
D		24 st.
K		12 st.



6

I		8 st.
M		2 st.

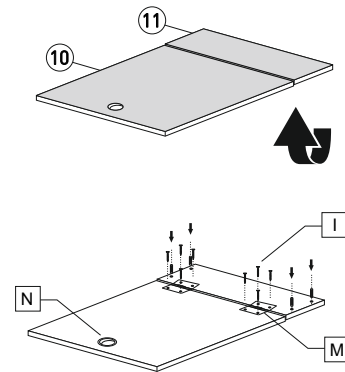

7

