

**D** Montageanleitung

**GB** Assembly Instructions

**CZ** Montážní návod

**SK** Návod na montáž

**FR** Notice de montage

**IT** Istruzioni di montaggio

**HU** Szerelési útmutató

**RO** Instrucțiuni de montaj

**NL** Handleiding voor de montage

**PL** Instrukcja montażu

**TR** Montaj talimatı

**RU** Инструкция по монтажу

# ALEGRA 3

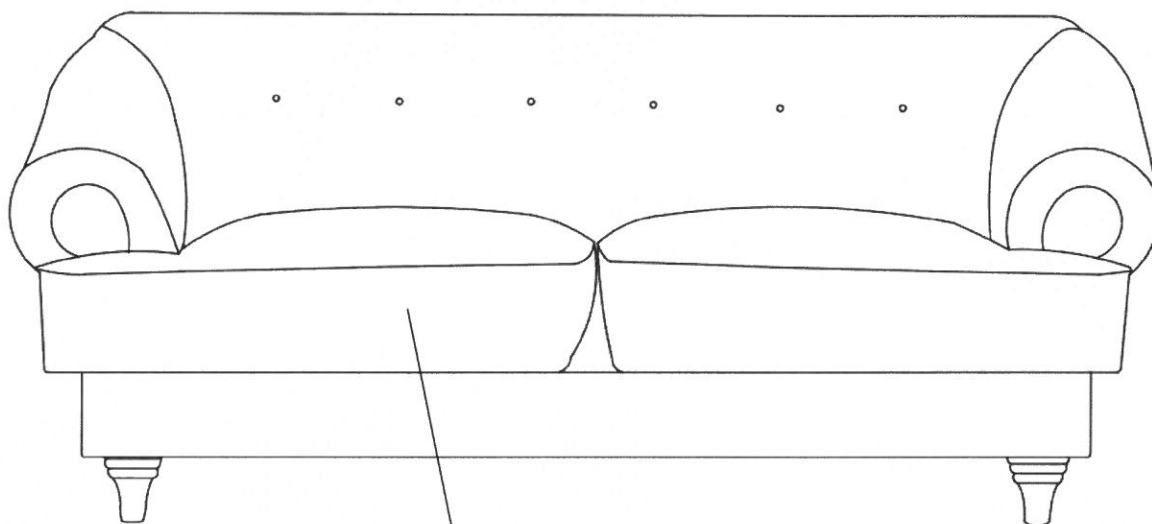
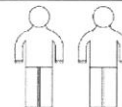

D

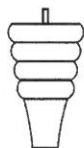

A

2x

B

4x

C

4x

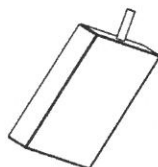
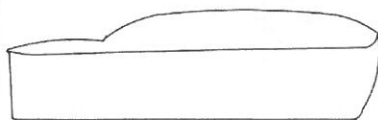

D

2x

E

2x

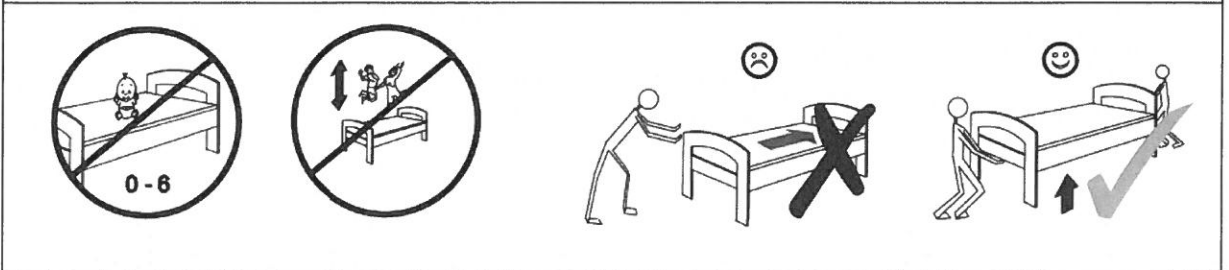
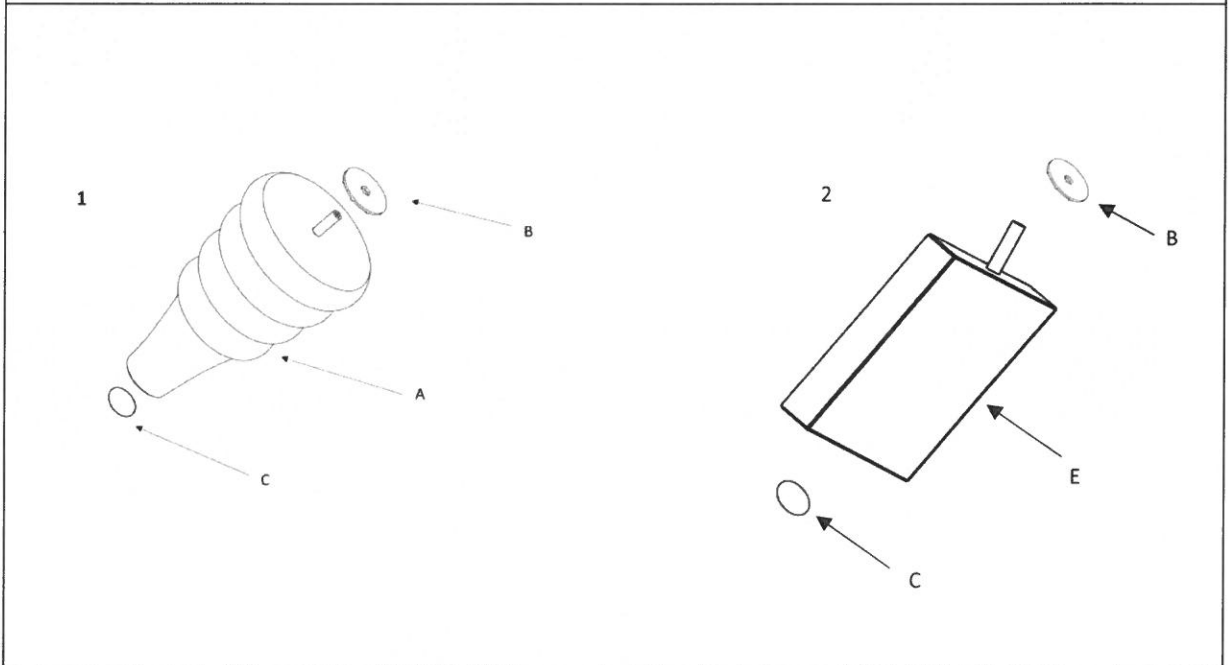
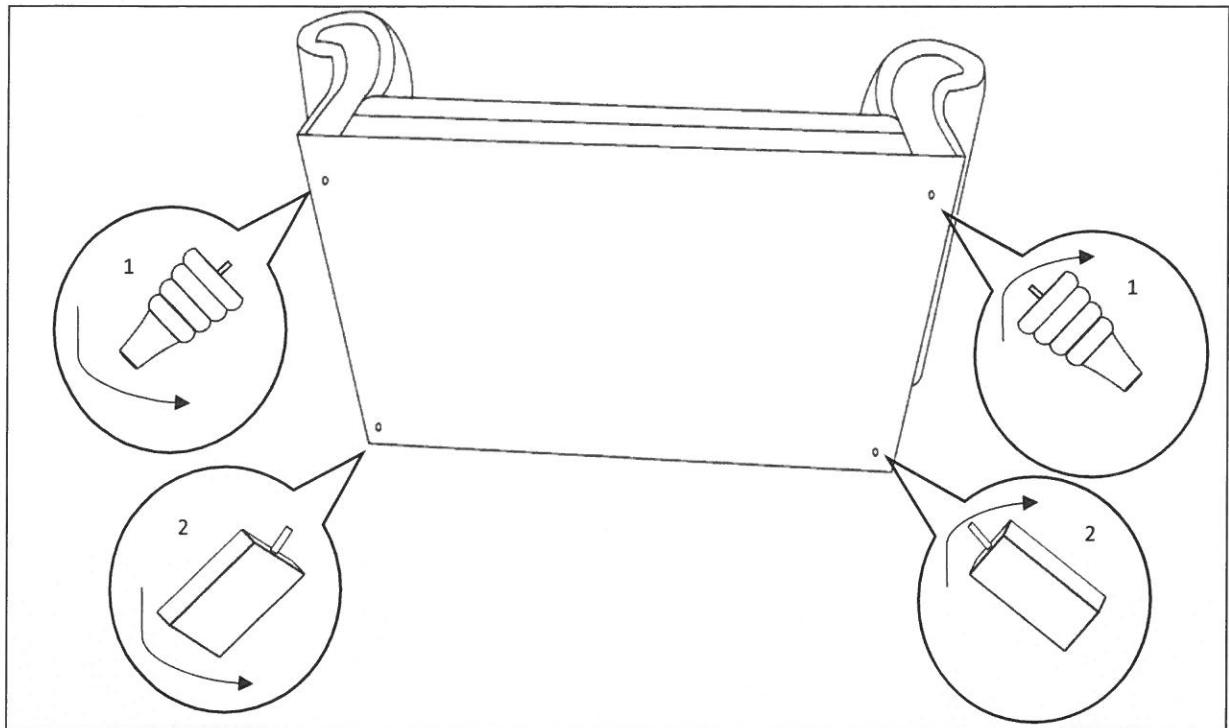

**Service • Assistenza • Dienstverlening • Serwis  
Servis • Szerviz • Сервисная служба**

Name • Naam • Nazwa • Isim • Название

**ALEGRA**

Nr. • No. • Номер

Typ • Type • Тип • Тип

**3**

