

Art. Nr. 2816001  
1/1H

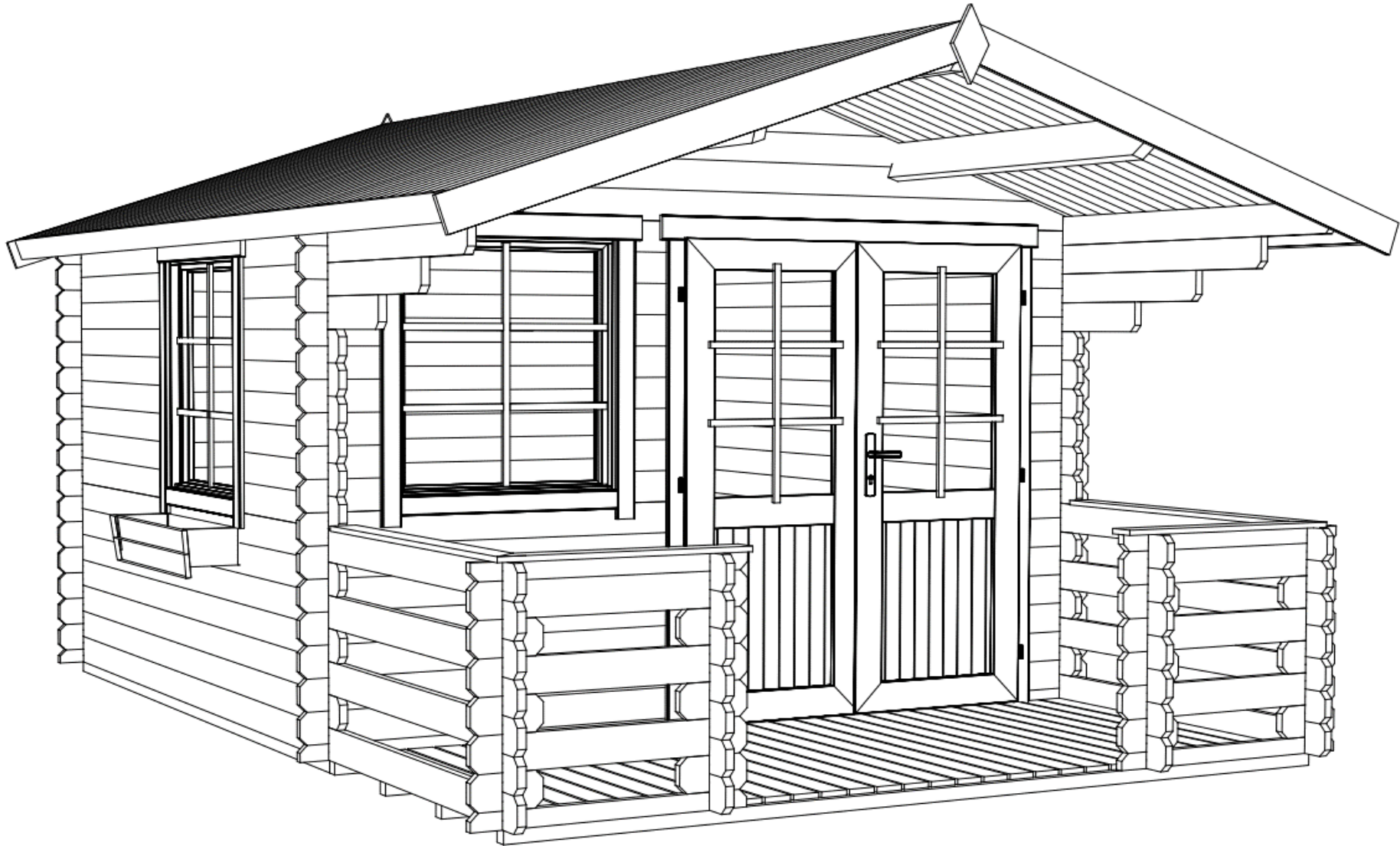

Art. Nr. 2816001

Groundplan - Grundplan - Plan de masse - Planimetria -  
Plattegrond - Põhiplaan

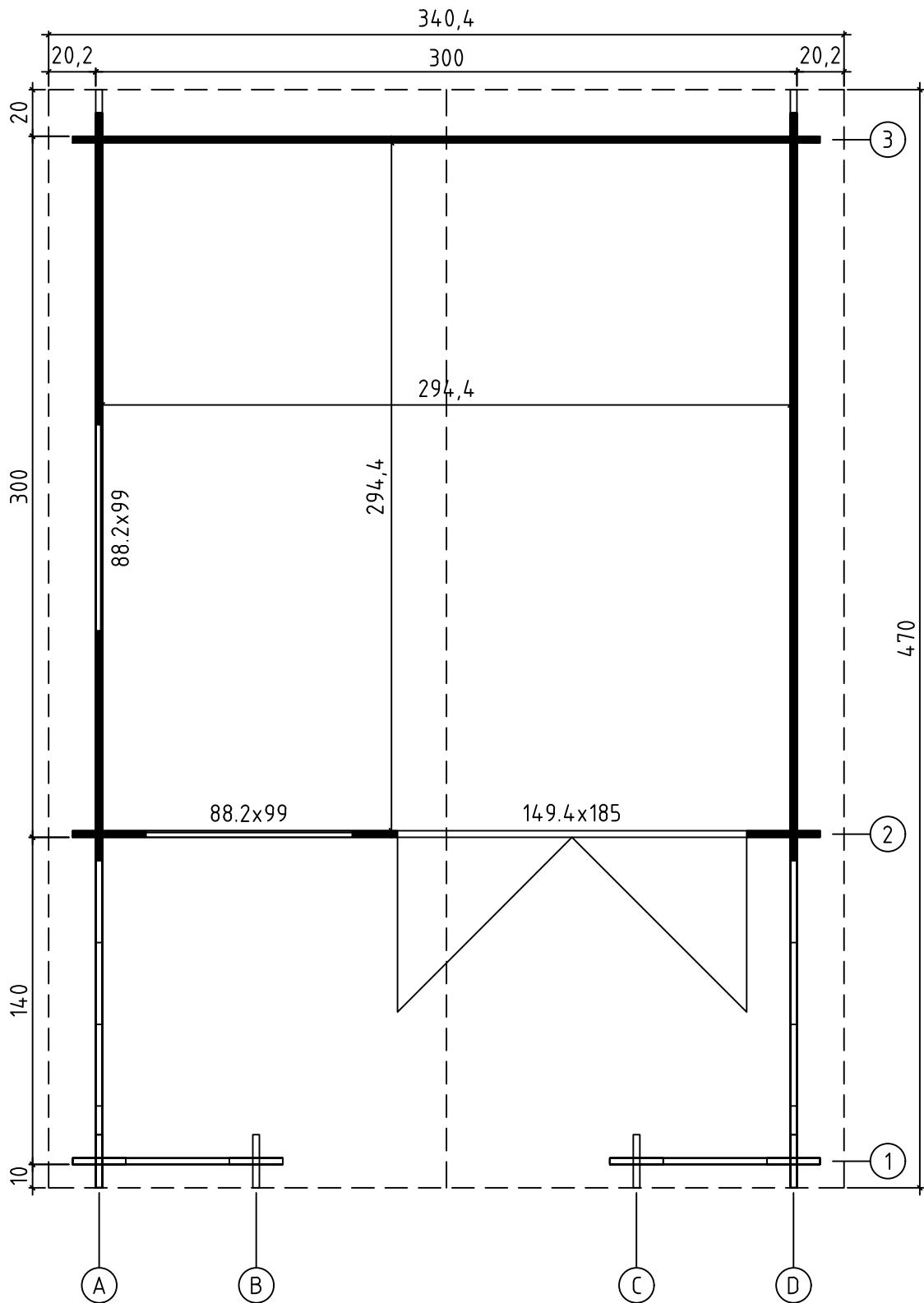

Art. Nr. 2816001

Foundation - Fundament - Fondation - Fondamenta -  
Fundering - Immutatud alusraam

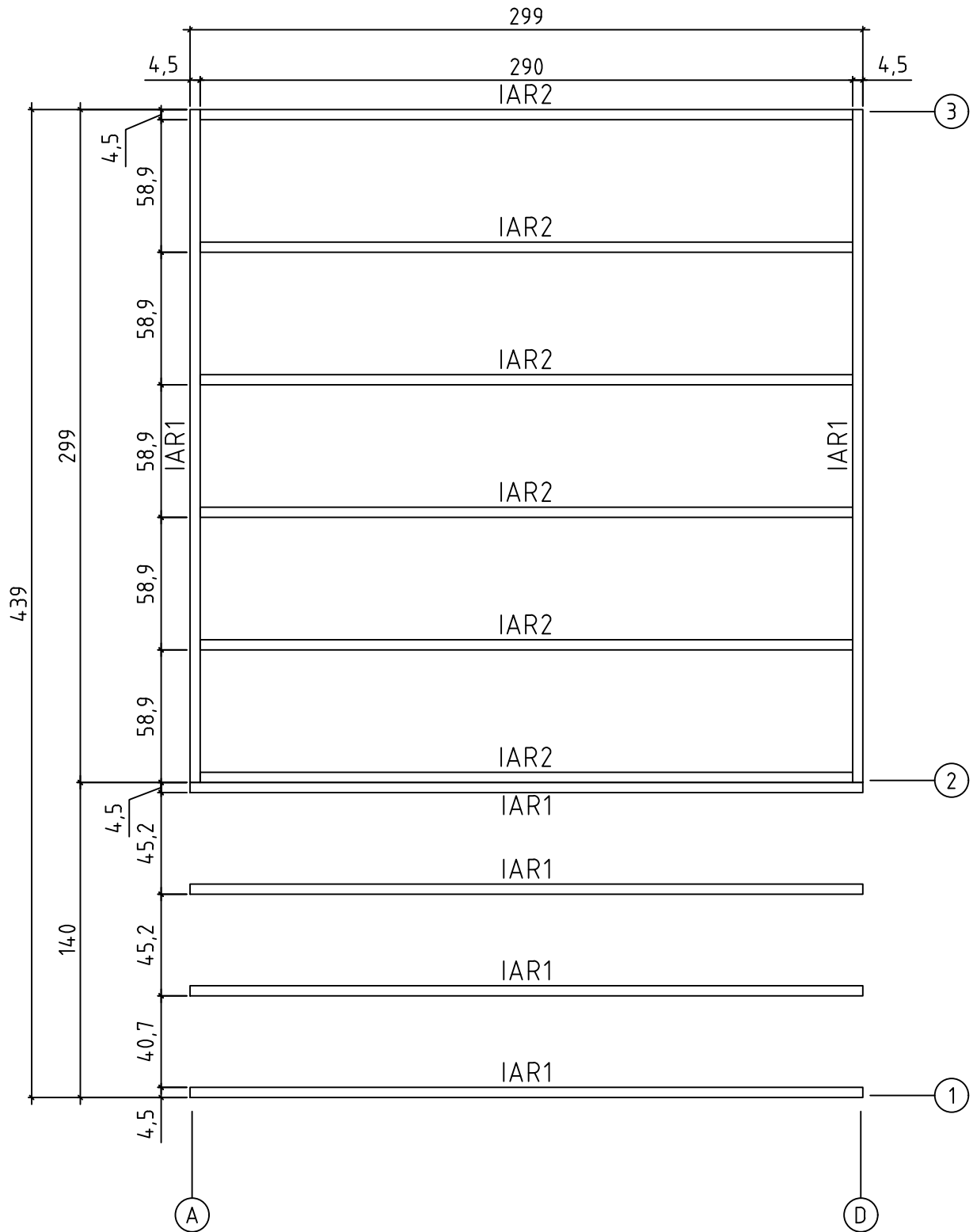

Art. Nr. 2816001

Floor boards - Fussbodenbretter - Plan pose plancher -  
Pavimento - Vloerhout - Põrandalaudis

Terrace boards - Terrassenbretter - Plancher de terrasse -  
Piattaforme terrazzo - Terrasvloer - Terrassilaud

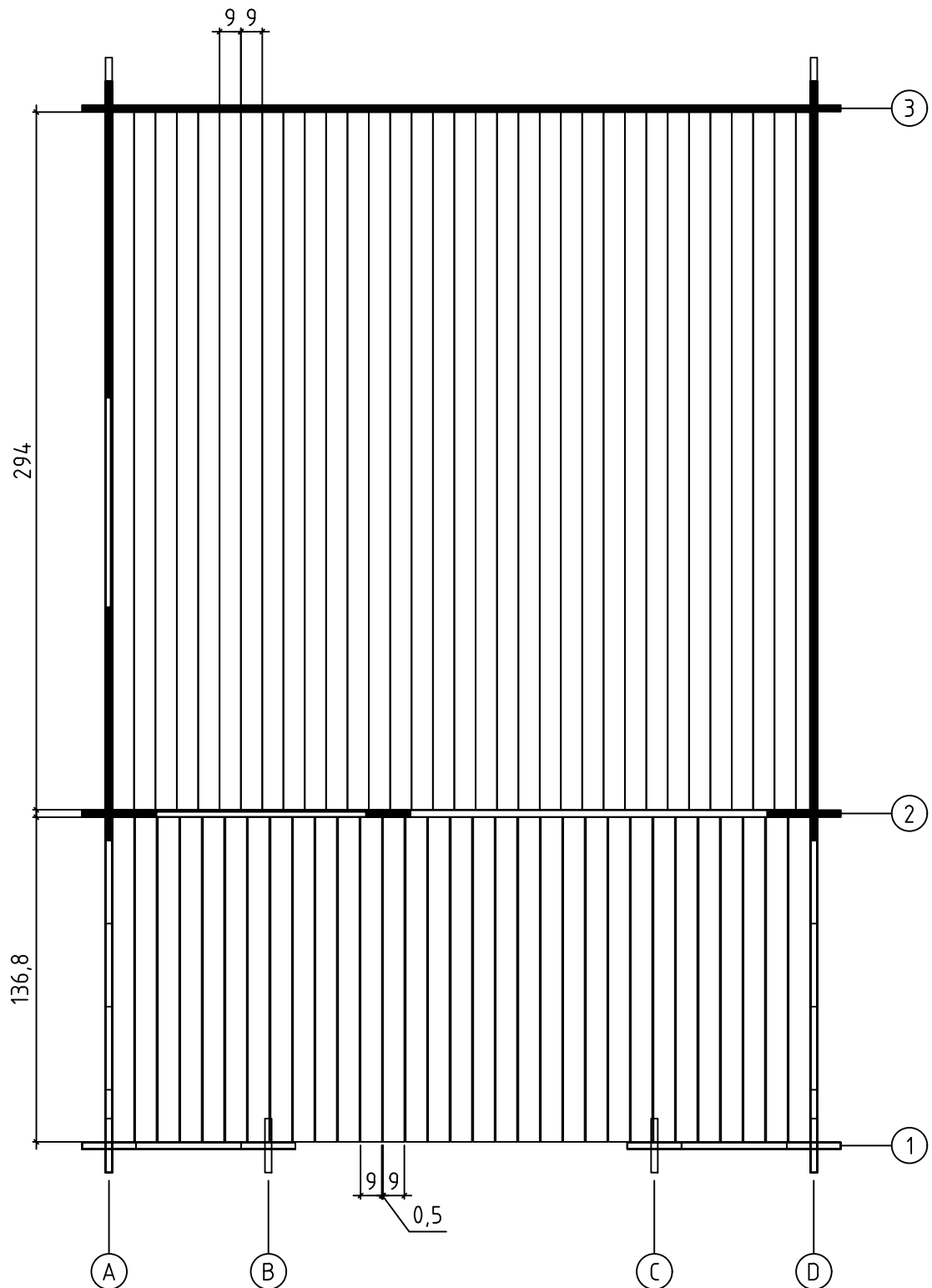

28.05.2018

4/13

# Art. Nr. 2816001

Without tongue - Ohne feder - Madrier de finition -  
Finale in legno - Zonder veer - Punnita

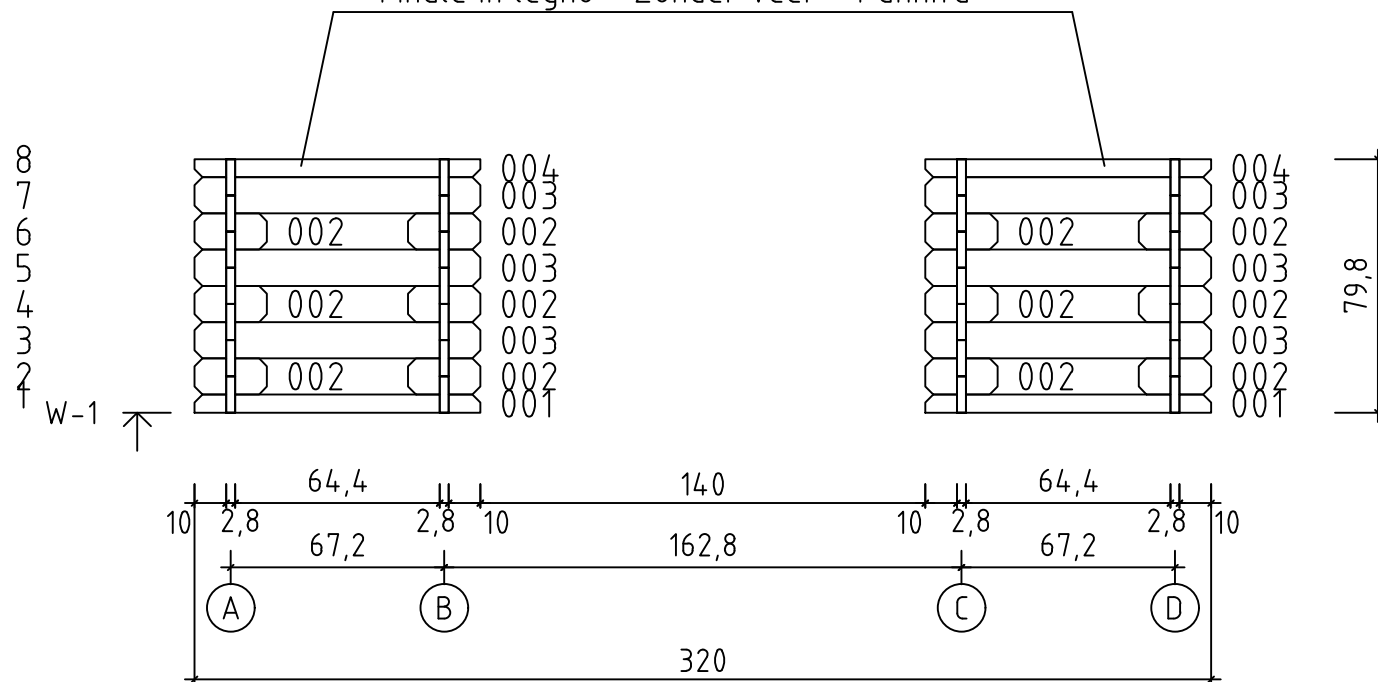

# Art. Nr. 2816001

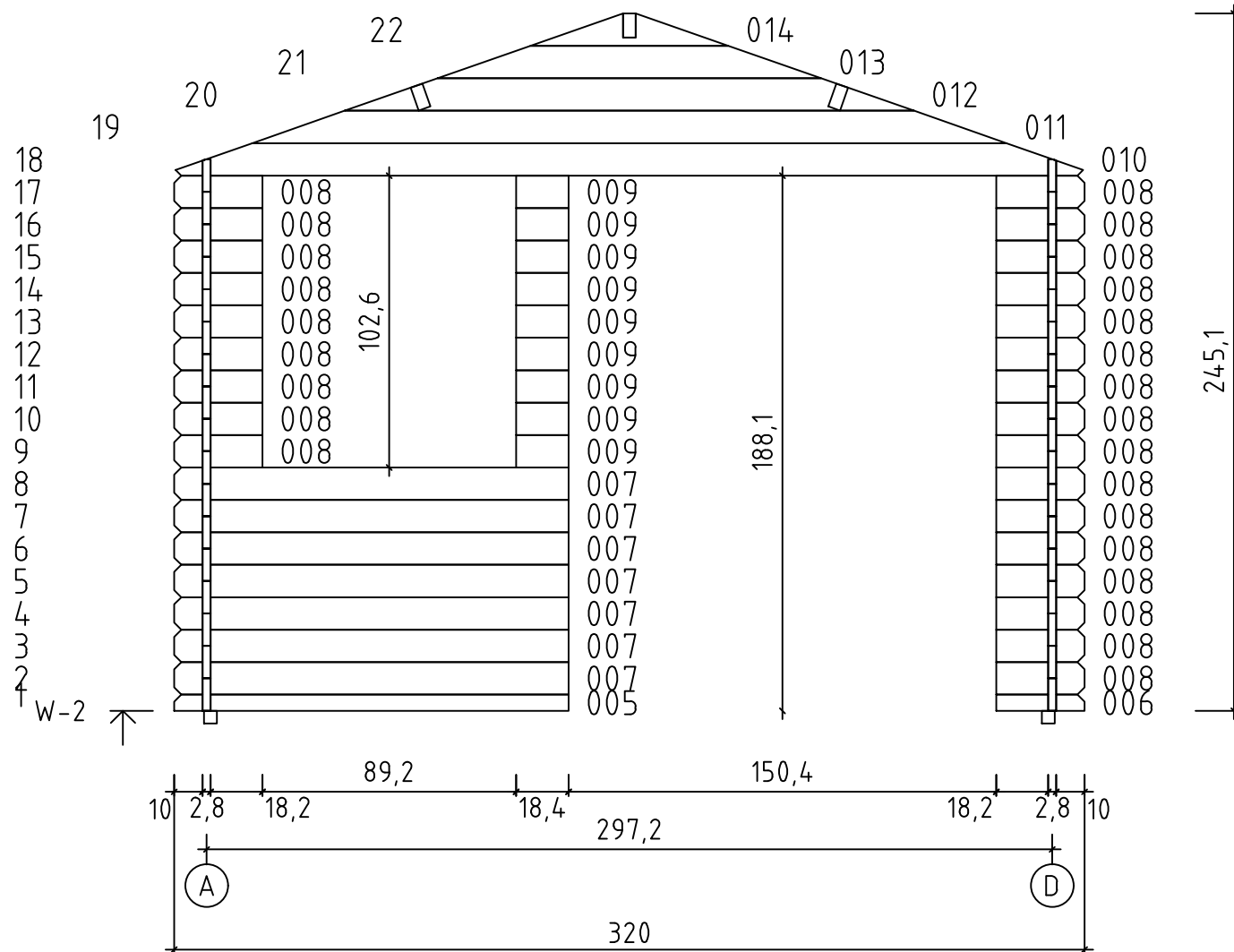

28.05.2018

6/13

Art. Nr. 2816001

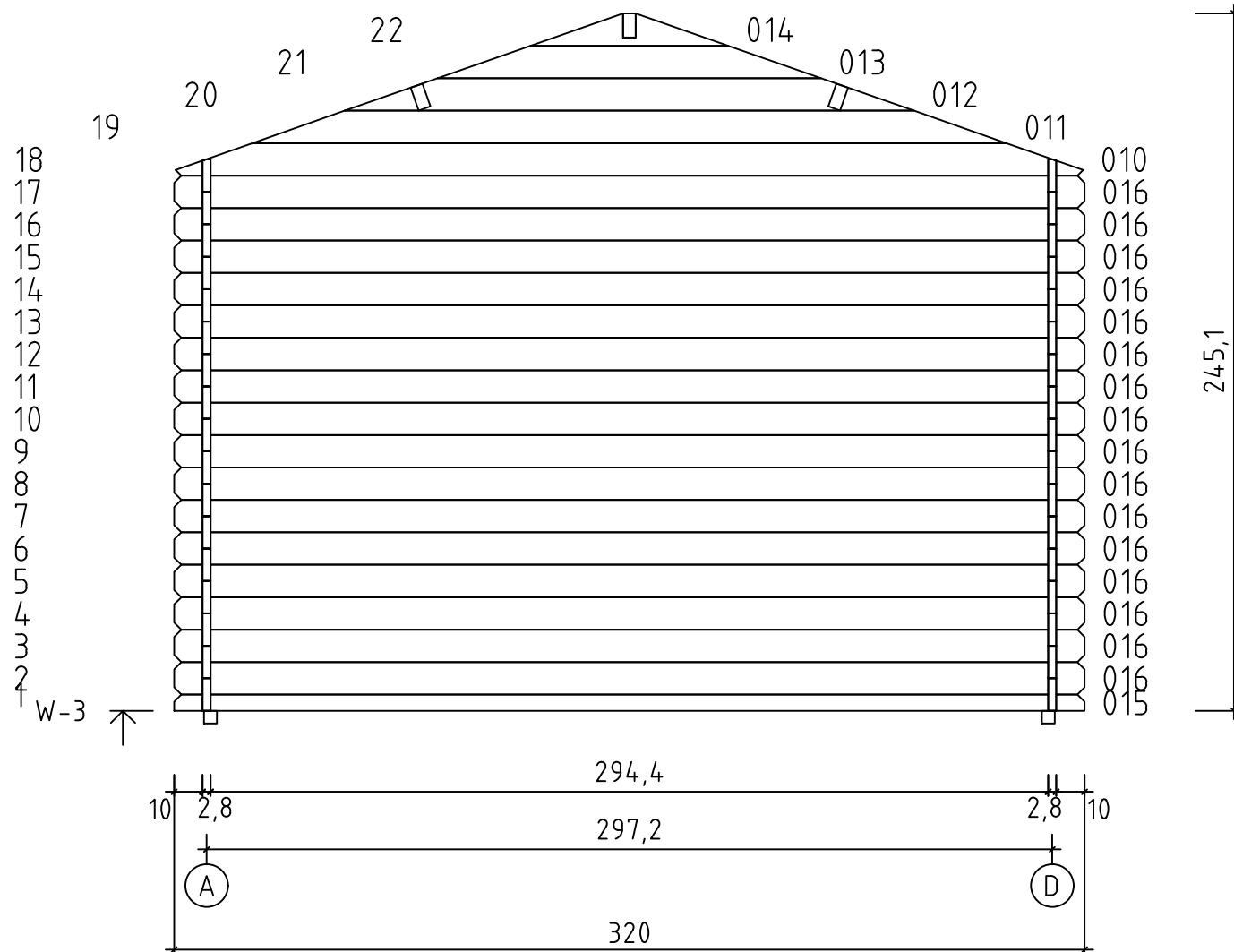

28.05.2018

7/13

# Art. Nr. 2816001

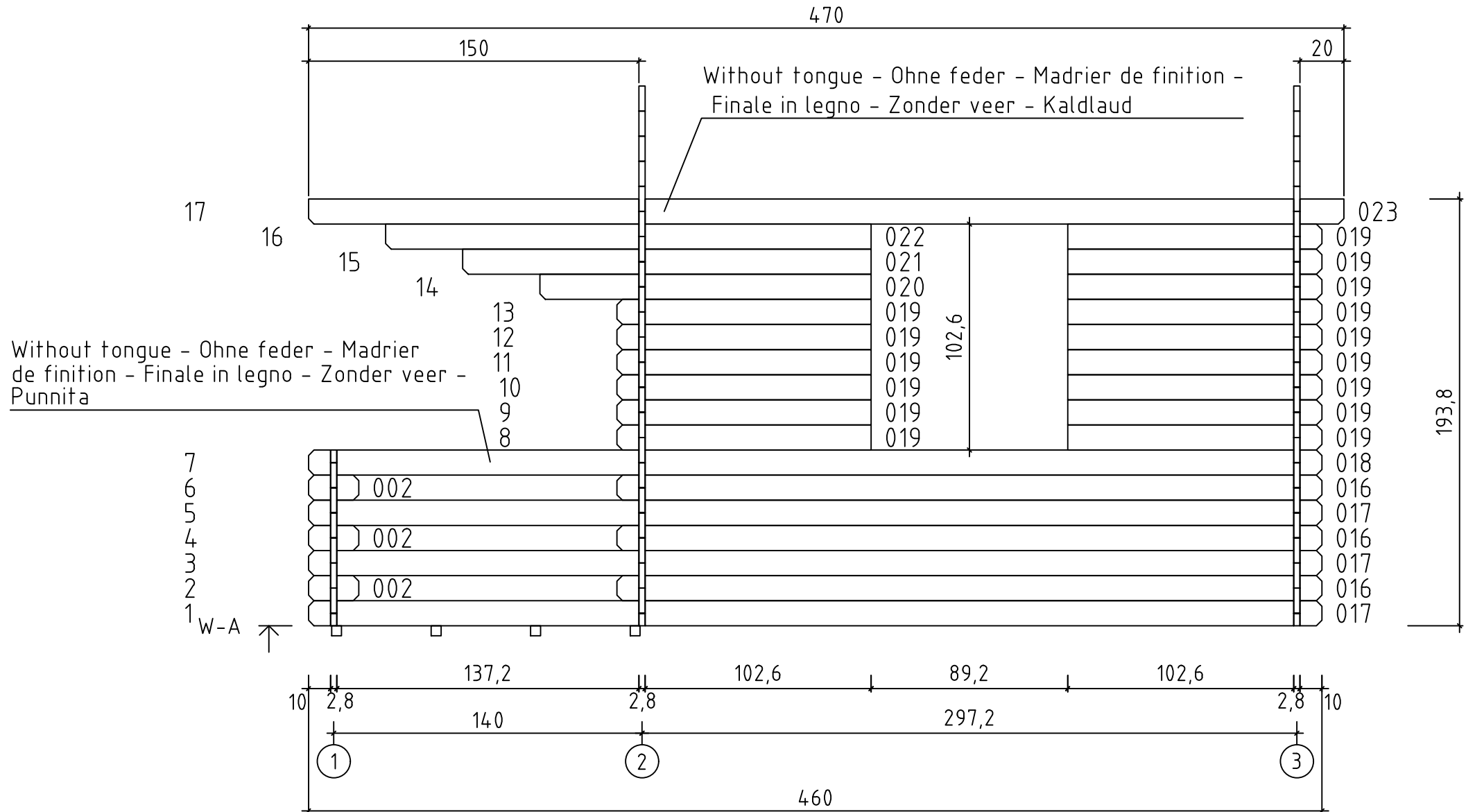

28.05.2018







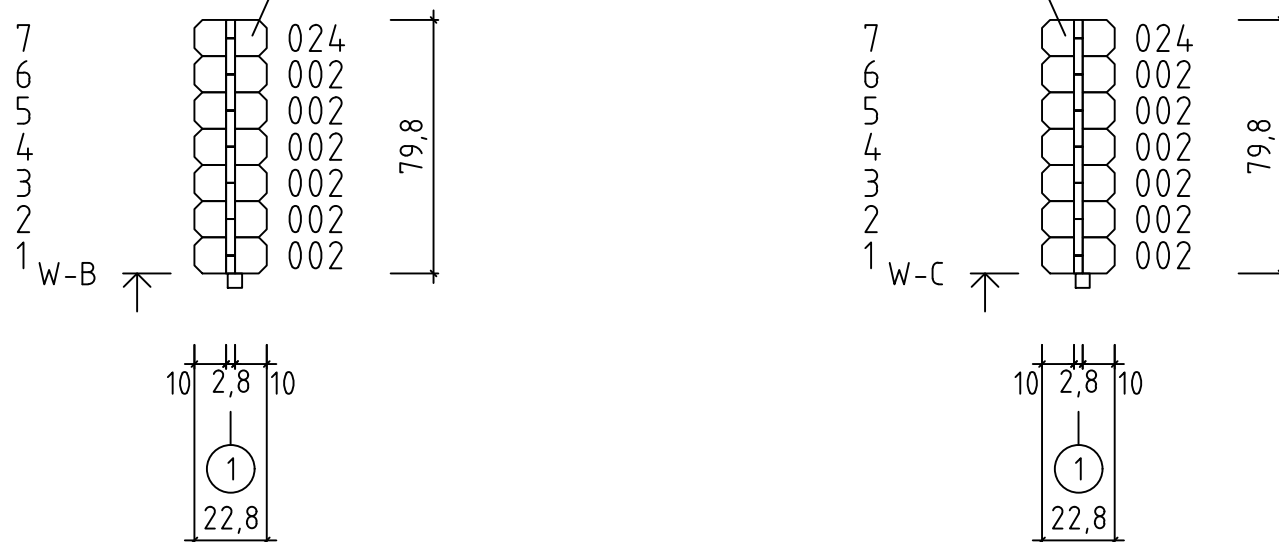



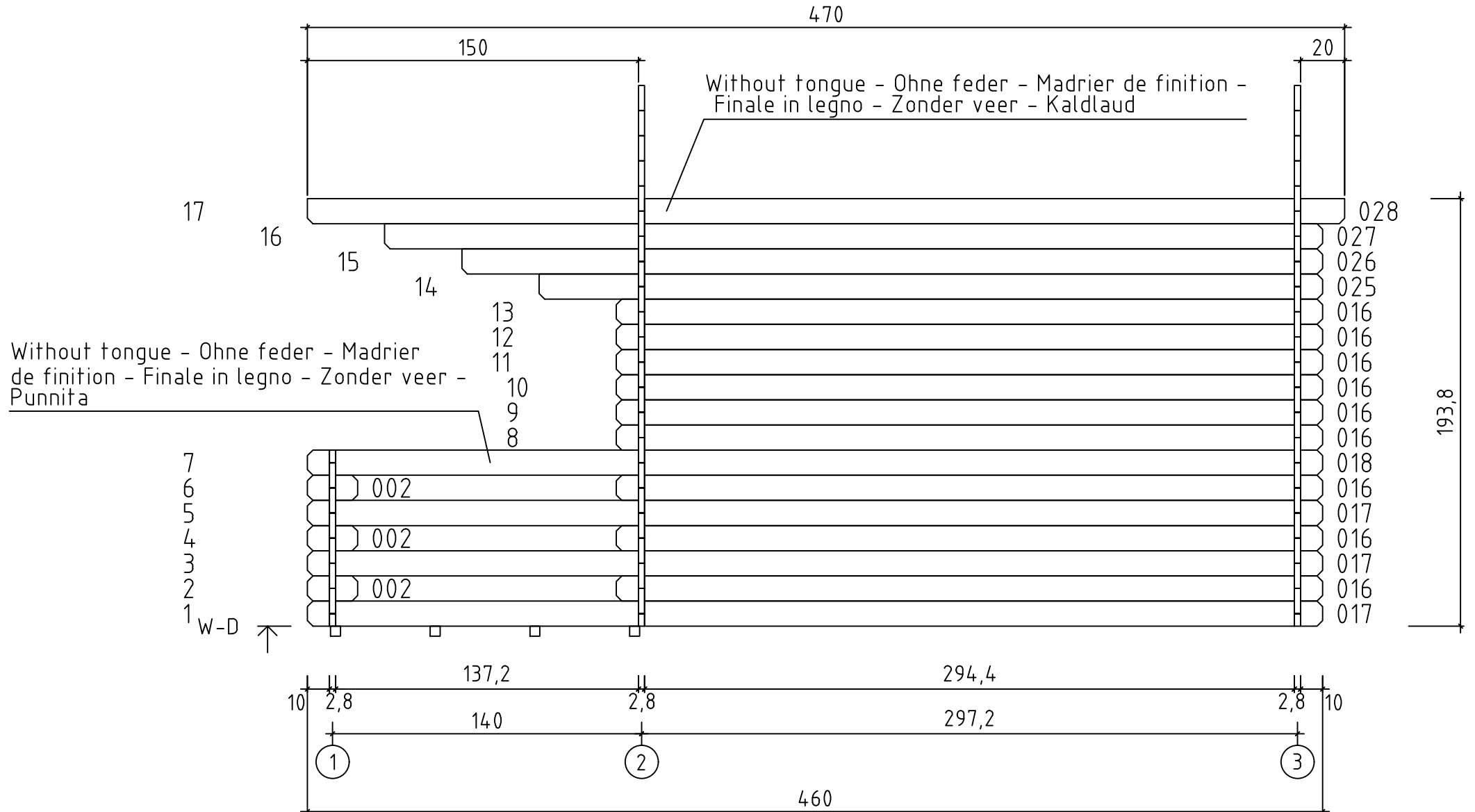

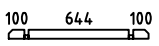
# Art. Nr. 2816001

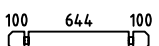
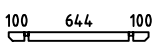
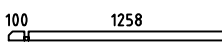
Without tongue - Ohne feder - Madrier de finition -  
Finale in legno - Zonder veer - Punnita

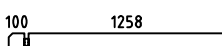

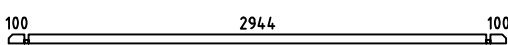
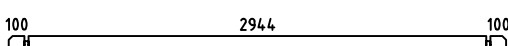
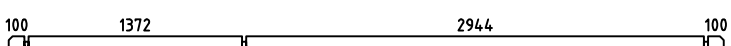
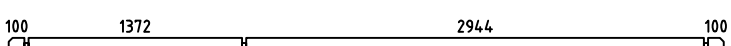
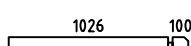
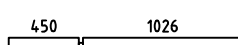
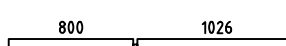
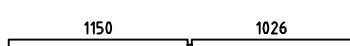

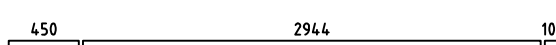

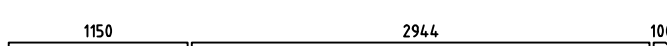
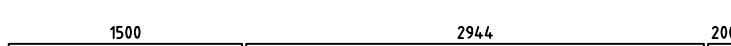



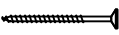

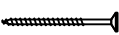
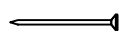

# Art. Nr. 2816001

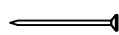
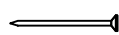
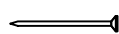

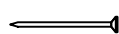

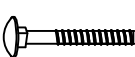



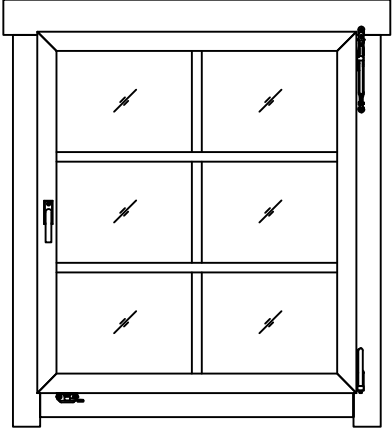
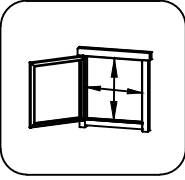
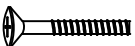
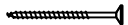

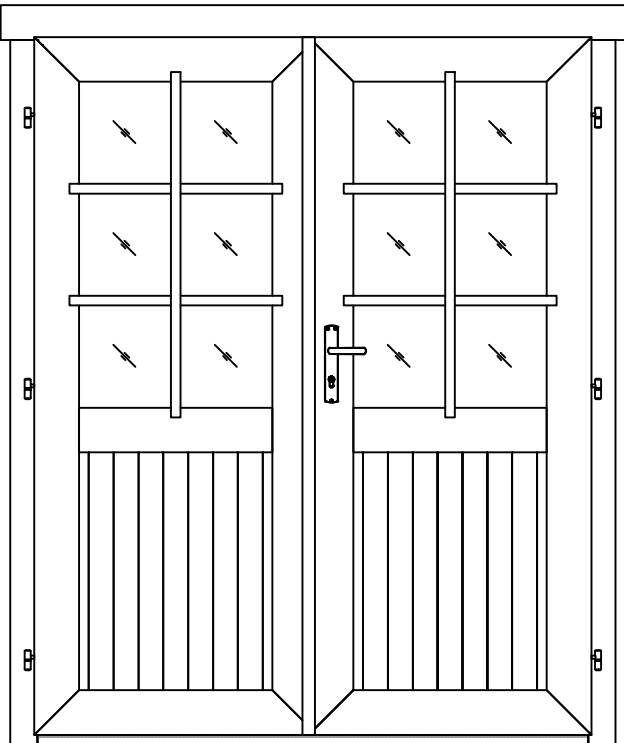
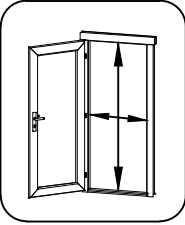
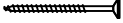
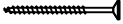
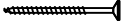
Pos	28.05.2018 Piece list - Stückliste - Liste des pièces - Elementi - Stuklijst - Tükítabel Art. Nr. 2816001 11/13	Q	P (mm)	L (mm)
001		2	28x57	900
002		30	28x114	228
003		6	28x114	900
004		2	28x53	900
005		1	28x57	1386
006		1	28x57	310
007		7	28x114	1386
008		25	28x114	310
009		9	28x114	184
015		1	28x57	3200
016		28	28x114	3200
017		6	28x114	4600
018		2	28x114	4600
019		15	28x114	1154
020		1	28x114	1504
021		1	28x114	1854
022		1	28x114	2204
023		1	28x120	4700
024		2	28x114	228
025		1	28x114	3550
026		1	28x114	3900
027		1	28x114	4250
028		1	28x120	4700

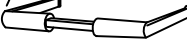
Pos	28.05.2018 Piece list - Stückliste - Liste des pièces - Elementi - Stuklijst - Tükital 12/13 Art. Nr. 2816001	Q	P (mm)	L (mm)
W2-1		1		
W3-1		1		
IAR1	Foundation - Fundament - Fondation - Fondamenta - Fundering - Immutatud alusraam 	6	45x45	2990
IAR2	Foundation - Fundament - Fondation - Fondamenta - Fundering - Immutatud alusraam 	6	45x45	2900
A-PR1	Roof beam - Dachbalken - Panne de toit - Perlina del tetto - Gordingen / dakbalk - Pärilin 1500 2944 200 	3	44x140	4700
	Floor boards - Fussbodenbretter - Lame de plancher - Pavimento - Vloerhout - Põrandalaud	33	90x18	2940
	Terrace boards - Terrassenbretter - Plancher de terrasse - Piattaforme terrazzo - Terrasvloer - Terrassilaud	31	90x19	1368
	Roof boards - Dachbretter - Voliges - Perlina per tetto - Dakhout - Katuselaud	106	90x18	1800
	Floor fillet - Fussbodenteiste - Corniere de finition du plancher - Finitura per pavimento (battisco pa) - Vloerafwerklijst - Põrandaliist		18x18	11.76
	Terrace edge board - Terrassenbrett, eingang - Lame de seuil d'entree de terrasse - Terrazzo uso abitacolo - Terrasvloer dorpel - Terrassi servaliist	1	19x28	1400
	Roofing felt fillet - Dachpappenleiste - Baguette de fixation du feutre bitumeux - Asse per fissaggio guaina bituminosa - Afdekljst asfaltpapier - Katusepapiilist	4	18x58	1850
	Roofing felt (strip) - Dachpappe (bahnen) - Feutre bitumeux (bande) - Cartone catramato - Asfaltpapier (baan) - Katusepapp	4		4800
TB-1	Fascia board - Traufbrett - Bandeau de toit - Finitura lati tetto - Gevellijst Räästalaud	4	18x90	2350
DRV-1	Roof edge reinforcement - Dachrandverstärkung - Corniere de renfort de bord de toit - Rinforzo x tetto - Dakrand versterking - Räästatugevdus	4	28x34	2350
	Guard-rail for terrace - Terrassengeländer - Main courante de terrasse - Guardrail per terrazzo - Terras leuning - Terrassi äärelaud	2	18x90	831
	Guard-rail for terrace - Terrassengeländer - Main courante de terrasse - Guardrail per terrazzo - Terras leuning - Terrassi äärelaud	2	18x90	1331
KFS-1	Storm protection - Sturmleiste - Latte anti-tempete - Protezione anti vento - Stormverankering / beveiliging - Tormikinnitusliist	4	22x45	2050
	Gable moulding - Giebelleiste - Planche de rive - Finitura per frontale e retro del tetto - Gevellijst - Viilulaud	4	18x120	1850
HS8	Screw for gable segment - Schrauben für deckblatt - Vis pour fixation losange de finition - Viti x frontali tetto - Schroef voor gevelpunt segment - Kruvi rombile	4	3.5x35	
HS9	Screw for gable moulding - Schrauben für giebelleiste - Vis pour fixation planche de rive - Vite per fissare finiture davanti e dietro del tetto - Schroef voor gevellijst - Kruvi viilulauale	24	3.5x50	
HS12	Screw for fascia boards - Schrauben für traufbretter - Vis pour fixation bandeau de toit - Viti x striscia del tetto - Schroef voor gevellijst - Kruvi räästalauale	22	4x40	

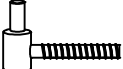
Pos	28.05.2018 Piece list - Stückliste - Liste des pièces - Elementi - Stuklijst - Tükítabel Art. Nr. 2816001	13/13	Q	P (mm)	L (mm)
HS12	Screw for roof edge reinforcement - Schrauben für dachrandverstärkung - Vis pour fixation corniere renfort de bord de toit - Viti x rinforzo bordo tetto - Schroef voor dakrand versterking - Kruvi räästatugevdusele		22	4x40	
HS12	Screw for terrace rear boards - Schrauben für terrassenrand - Vis de fixation pour main courante de terrasse - Vite per il piano posteriore della terrazza - Schroef voor terras afsluitplint (achterzijde) - Kruvi terrassi äärelaualae		16	4x40	
HS18	Screw for gable - Schrauben für giebel - Vis pour fixation des pignons - Viti per timpano - Schroef voor gevelpunt - Kruvi kelba kinnitamiseks		4	5x120	
HS18	Screw for roof beams - Schrauben für dachbalken - Vis pour fixation pannes de toit - Viti per perline del tetto - Schroef voor gordingen / dakbalken - Kruvi pärlinitele		6	5x120	
HS16	Screw for 1. wall beam - Schraube für 1. bohlenreihe - Vis de fixations 1ere rangée de madriers avec poutrelles de fondations - Vite fissaggio alle fondamenta - Schroef voor 1 wandbalk - Kruvi poollauale		11	5x90	
HS16	Screw for foundation - Schrauben zur befestigung fundament - Vis de fixations des poutrelles de fondations - Viti x fondamenta - Schroef voor fundering - Kruvi alusraamile		14	5x90	
NF2	Zn nail for floor fillet - Zn nägel für fussbodenleiste - Pointe pour corniere de finition du plancher - Chiodi x fissaggio pavimento - Spijker(nagel) voor vloer afdekljst - Nael põrandaliistule		24	1.4x40	
SH28	Hammer block - Schlagholz - Calle de frappe - Blocco di legno da usare come cuscinetto quando si usa il martello - Slagklos - Löögiklots		1		
SFS	Nut for storm protection - Schraubenmutter für sturmleiste - Ecrou pour latte anti-tempete - Dado x asta protezione vento - Moer voor stromverankering - Mutter tormikinnitusliistule		8	D6	
BK	Flower box - Blumenkasten - Jardiniere - Fioriera - Bloembak - Lillekast	Art. Nr. 990600	1		
NF3	Nail for terrace edge board - Nägel für terrassenbrett - Clou de fixation de lame de seuil d'entree de terrasse - Chiodi per unire delle assi del terrazzo - Spijker(nagel) voor terrashout - Nael terrassi servaliistule		5	2.1x50	
NF3	Zn nail for terrace - Zn nägel für terrassenbretter - Pointe pour plancher de terrasse - Chiodo zincato per terrazza - Spijker(nagel) voor terrasvloer - Nael terrasilauale		248	2.1x50	
NF4	Zn nail for roof - Zn nägel für dachbretter - Pointe pour fixation voliges de toit - Chiodi x perline tetto - Spijker(nagel) voor dakhout - Nael katuselauale		332	2x50	
NF4	Zn nail for floor - Zn nägel für fussbodenbretter - Clous pour plancher - Chiodi x perline pavimento - Spijker(nagel) voor vloer - Nael põrandalauale		204	2x50	
NF5	Zn nail for roofing felt fillet - Zn nägel für dachpappenleiste - Pointe pour baguette de fixation feutre bitumeux - Chiodi x carta bituminosa x tetto - Spijker(nagel) voor asfaltpapier afdekljst - Papiliistunael		20	2x40	
NF6	Roofing nails for roofing felt - Nägel für dachpappe - Pointe pour fixation feutre bitumeux - Chiodi per cartone catramato - Asfaltnagel - Papinael		198	2.8x15	
BFS	Bolt for storm protection - Bolzen für sturmleiste - Boulon pour latte anti-tempete - Bullone x asta protezione vento - Bout voor stormankerlat - Puidupolt tormikinnitusliistule		8	6x60	
GS	Gable segment - Deckblatt - Losange de finition - Decorazione in legno x frontale tetto - Gevelpunt segment - Romb		2		
DFS	Washer for storm protection - Dichtscheibe für sturmleiste - Rondelle pour latte anti-tempete - Rondella x asta protezione vento - Afdichtring voor storm strip - Seib tormikinnitusliistule		8	D6	
	Window - Fenster - Fenetre - Finestra - Raam - Aken	882x990 AK.1.106.SSP.a SGC	2		
	Door - Tür - Porte - Porte - Deur - Uks	1494x1850 TUK.2.056.SVP.MMc SGC	1		

Pos	06.09.2016 Piece list - Stückliste - Liste des pièces - Elementi - Stuklijst - Tükítabel 882x990 AK.1.106.SSP.a SGC	1/1	Q	P (mm)	L (mm)
	<p data-bbox="263 152 1284 183">Glass size - Glasgröße - Taille de la vitre - Misura del vetro - Glas afmeting - Klaasi mõõt: 738x846 mm</p> <div data-bbox="657 241 1050 672" style="text-align: center;">  </div> <div data-bbox="1337 152 1524 331" style="text-align: right;">  <p data-bbox="1369 347 1492 376">782x890 mm</p> </div>				
FS1	Window handle fittings - Fenstergriff - Poignée de fenetre - Maniglia c/ferramenta - Raamhendel -/grendel -/klink - Aknalink		1		
FSP	Bolt for window handle fittings - Bolzen für fenstergriff beschlag - Vis pour fixation poignée de fenetre - Bullone x apertura manuale finestra - Schroef voor raamhendel - Akna käepideme polt		2		
HS1	Screw for georgian bars - Schraube für sprossen - Vis pour croisillons - Viti per unire la griglia georgiana della finestra - Schroeven voor raamverdeling - Krugi akna petfeliistule		6	2.5x20	

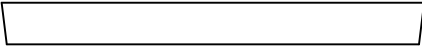
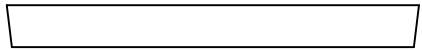
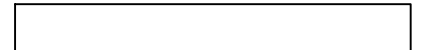
Pos	13.01.2017	Piece list - Stückliste - Liste des pièces - Elementi - Stuklijst - Tükítabel 1494x1850 TUK.2.056.SVP.MMc SGC	1/1	Q	P (mm)	L (mm)
		Glass size - Glasgröße - Taille de la vitre - Misura del vetro - Glas afmeting - Klaasi mõõt: 514x855 mm    1394x1768 mm				
HS1	Screw for georgian bars - Schraube für sprossen - Vis pour croisillons - Viti per unire la griglia georgiana della finestra - Schroeven voor raamverdeling - Kruvi ukse peffeliistule		12	2.5x20		
HS4	Screw for door fillet - Schraube zur befestigung türleiste - Vis pour fixation baguette d'arret de porte - Viti per massellino della porta - Schroef voor deurlijst - Kruvi ukse kokkuvaltsiliistule		5	3x30		
HS16	Screw for door jamb - Schraube für türrahmen - Vis de fixation partie haute avec montants du cadre de porte - Viti x fissaggio montanti porte - Schroef voor deurkozijn - Kruvi ukse lengile		4	5x90		
HS25	Screw for doorstep - Schrauben für swelle - Vis pour fixation barre de seuil - Vite per soglia della porta - Schroef voor deurdorpel - Kruvi lävepakule		3	4.5x65		
TL4	Door handle fittings - Türgriff - Poignée de porte - Maniglie - Deurhendel / klink - Ukse käepide VU		1			
TL5	Set of door lock covers - Schlossblenden - Set de garnitures de porte - Copertura serrature - Slot sluitplaat set - Ukse lukuplaat		1			
	Cylinder lock - Zylinderschloss - Barillet de porte - Serratura - Cylinder slot - Ukse lukusüdamik		1	30x35		
	Male bolt hinge for door - Türband - Partie male de paumelle de porte - Cerniera anube x porta - Scharnier bout - Ukse polthing isane		6			
	Striker for barrel bolt - Hülse für grendelriegel - Gache au sol du targette - Boccola per fermo della porta - Huls voor vergrendelingsschuif - Vasturaud ukse servariivile		2			

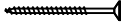
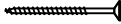
Pos	02.07.2012	Piece list - Stückliste - Liste des pièces - Elementi - Stuklijst - Tükítabel Flower box - Blumenkasten - Jardiniere - Fioriera - Bloembak - Lillekast Art.Nr. 990600	1/1	Q.	P (mm)	L (mm)
ES1				1	18x90	906
ES2				1	18x90	884
TS				1	18x140	846
PL				3	18x140	201
KL				2	18x140	200
SH100	Screw for flower box - Montagschraube für blumentasten - Vis assemblage des jardinieres - Viti per fioriera - Montageschroeven voor bloembak - Kruvi lillekasti montaažiks			28	3.5x50	
SH100	Screw for fixing flower box to the walls - Schraube zur Befestigung den blumenkasten - Vis de fixation au mur des jardinieres - Viti per fissare la fioriera alle pareti - Schroeven voor bevestiging bloembak met wand - Kruvi lillekasti kinnitamiseks seinale			3	4x40	

