

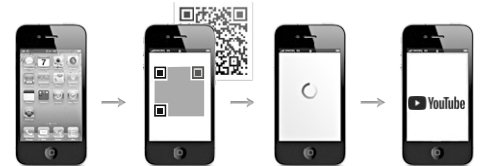

- | | | |
|---|--|--|
| (D) Videounterstützte Montageanleitung | (GB) Video-assisted assembly instructions | (FR) Instructions de montage assistées par vidéo |
| (TR) Video destekli kurulum talimatları | (IT) Istruzioni di montaggio video-assistite | (NL) Video-ondersteunde montage-instructies |
| (RU) инструкция по монтажу с помощью видеосигнала | (CZ) Instalační pokyny podporované videem | (HU) Video-támogatott telepítési utasítások |
| (RO) Instrucțiuni de instalare acceptate video | (PL) Instrukcje montażu wspomagane sygnałem wizyjnym | (SK) Inštaláčné pokyny podporované videom |

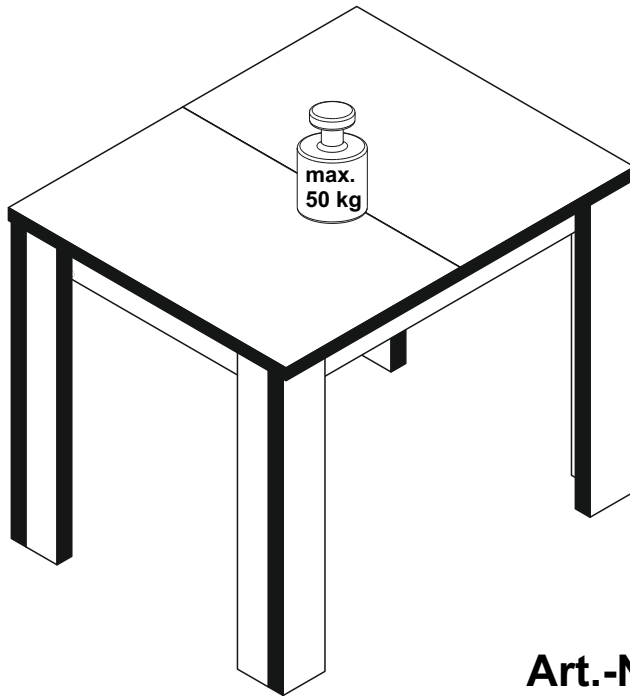

Art.-Nr.: **0567_80x60**
Esstisch

REPC-Nr.:



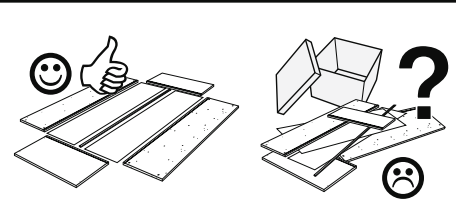
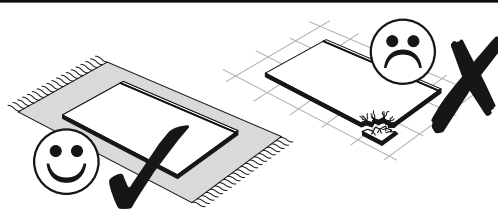
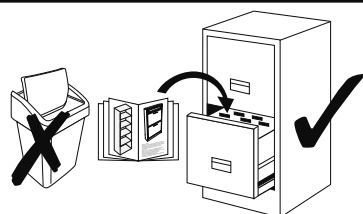
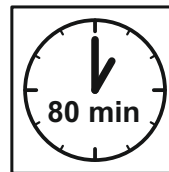
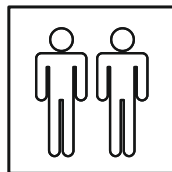
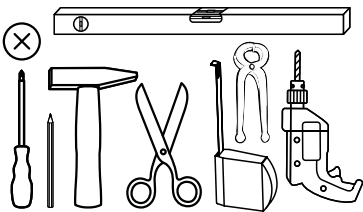





**Service • Assistenza • Dienstverlening • Serwis
Servis • Szerviz • Сервисная служба**



SCAN ME

Das Ersatzteil-Anforderungsformular finden Sie auf
The replacement parts requisition form you find on
<https://www.maeusbacher.de/ersatzteile/>





Beutel 0567_80x60 0-12 Colli 1/1

B01-80		B01-122		B01-315		B02-211		B02-212	
16x	3,5x13	24x	4x13	4x		4x		4x	
B02-215		B05-130		B05-190					
4x		1x		8x					

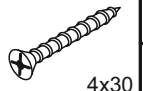

▶ SCAN ME

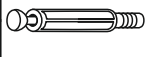
Beutel 0567_80x60 0-22 Colli 1/1

B01-10		B01-140		B02-10		B02-20		B05-20	
4x	6,3x50	32x	4x30	8x		8x		8x	

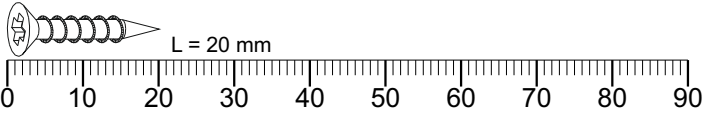

Colli 1/1

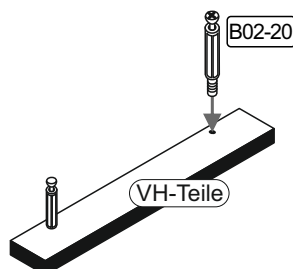
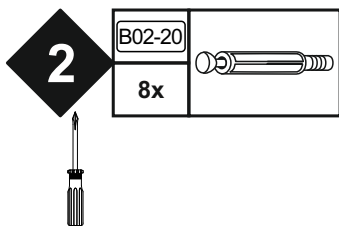
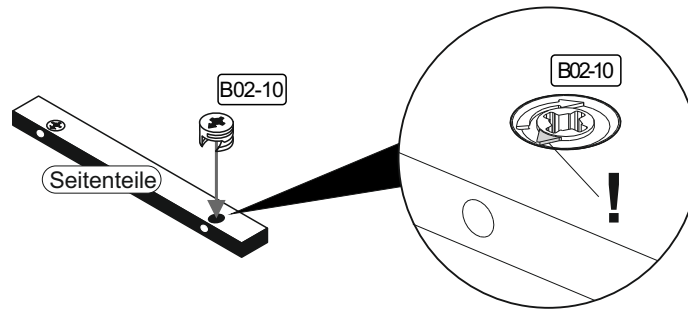
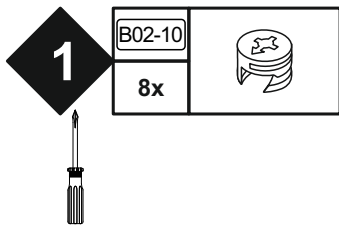
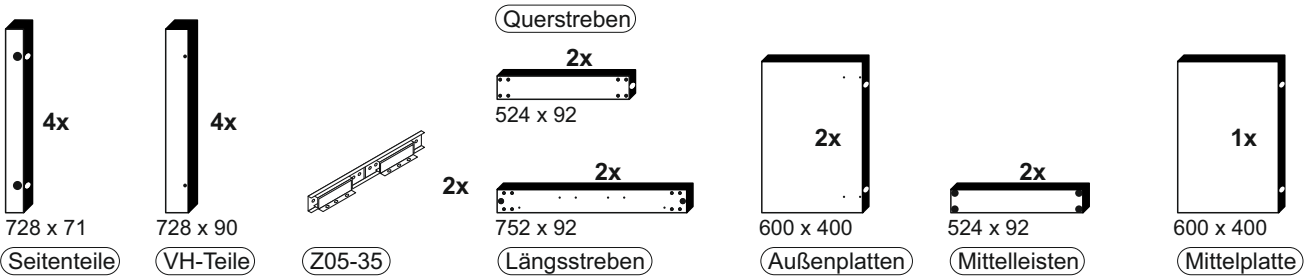



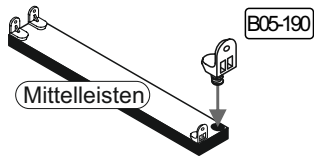

3

B05-190	
8x	



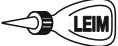

4

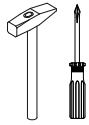
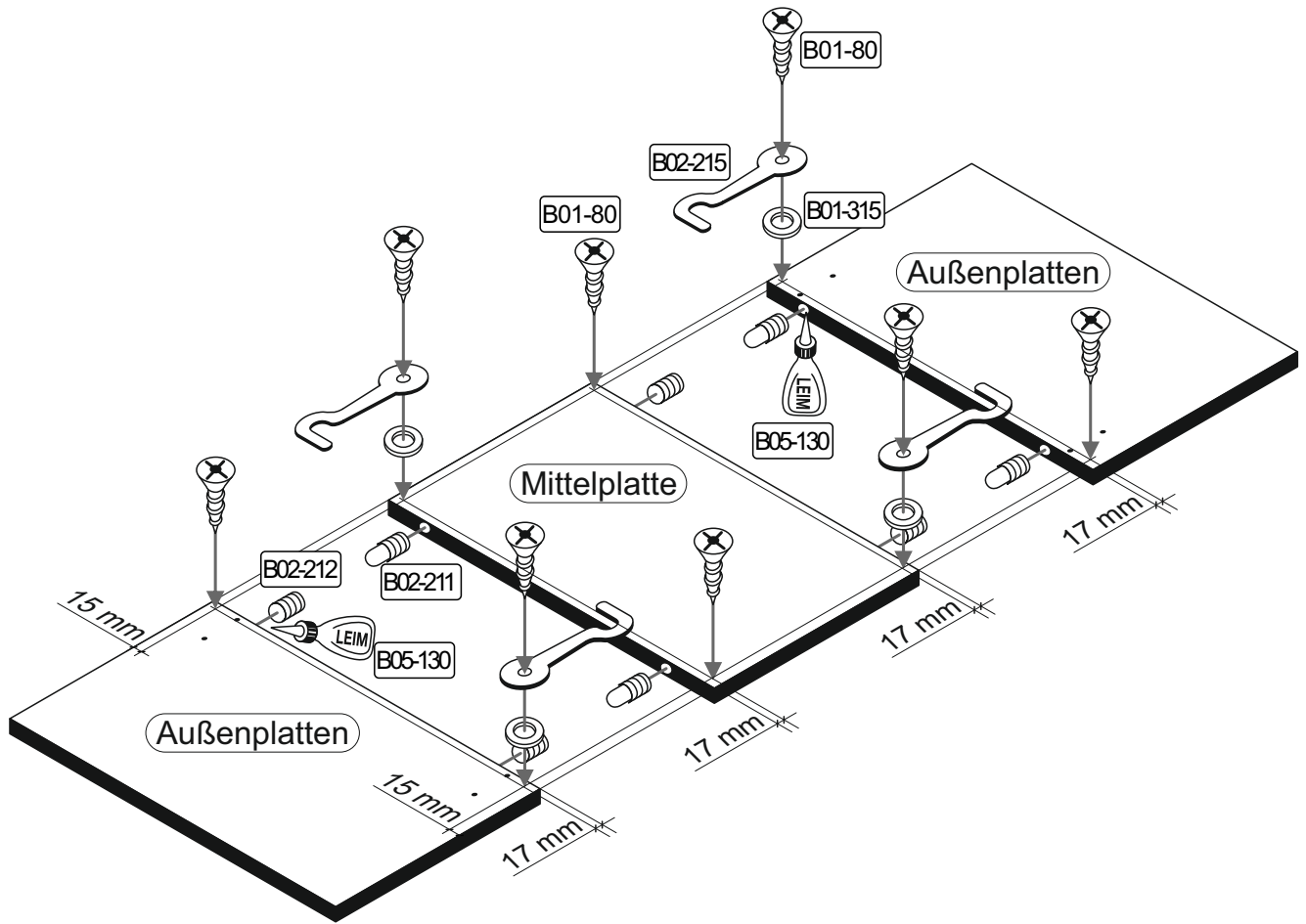
B01-80		B01-315		B02-211		B02-212		B02-215		B05-130	
8x	3,5x13	4x		4x		4x		4x		1x	

5

B05-20	
8x	

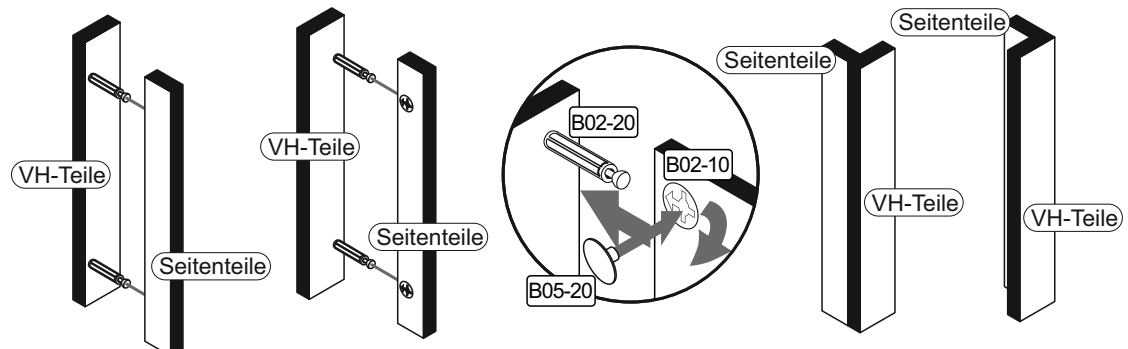

Vor der Montage der Tischauszüge muß das Untergestell mittig auf den Oberplatten ausgerichtet werden.

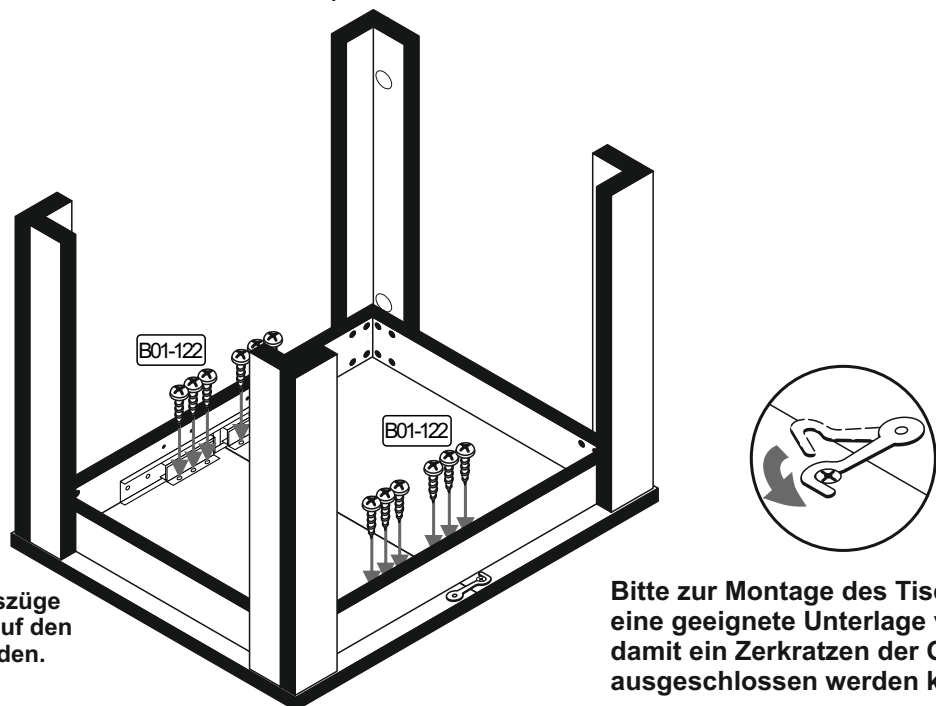
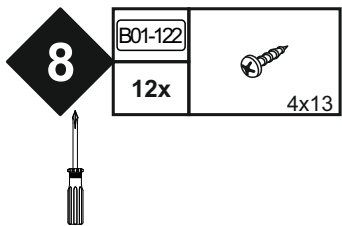
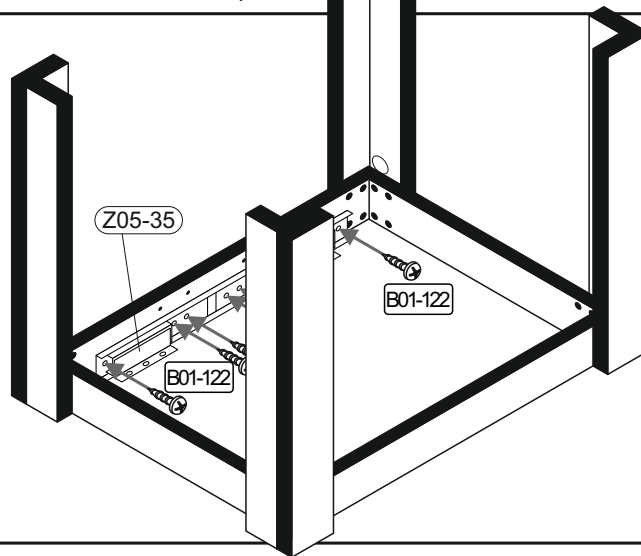
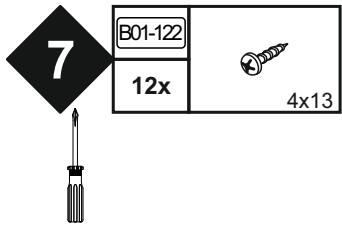
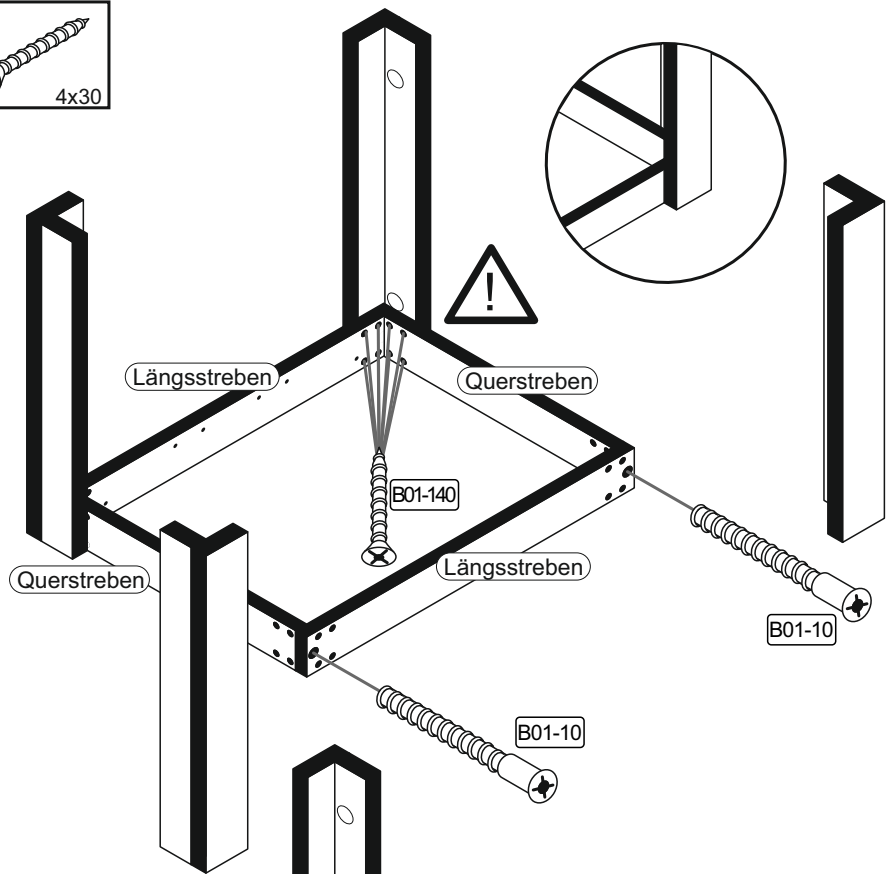
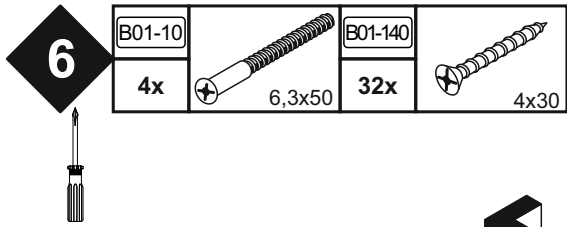
Bitte zur Montage des Tisches eine geeignete Unterlage verwenden, damit ein Zerkratzen der Oberplatte ausgeschlossen werden kann!

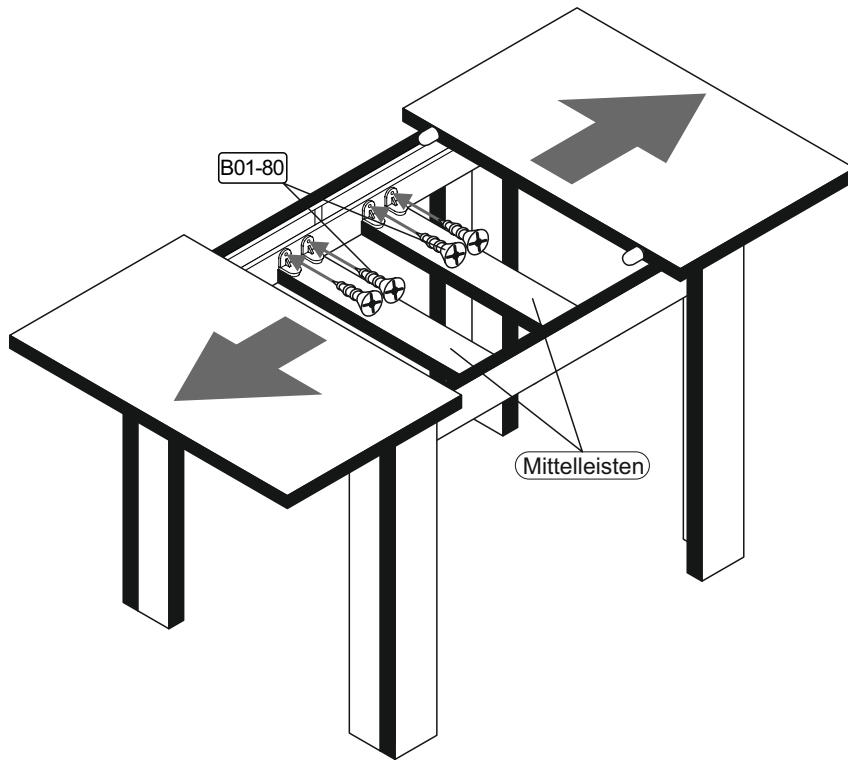
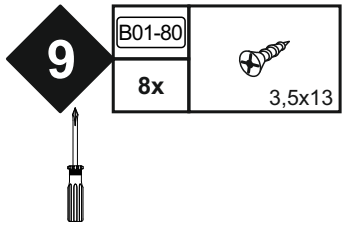

10

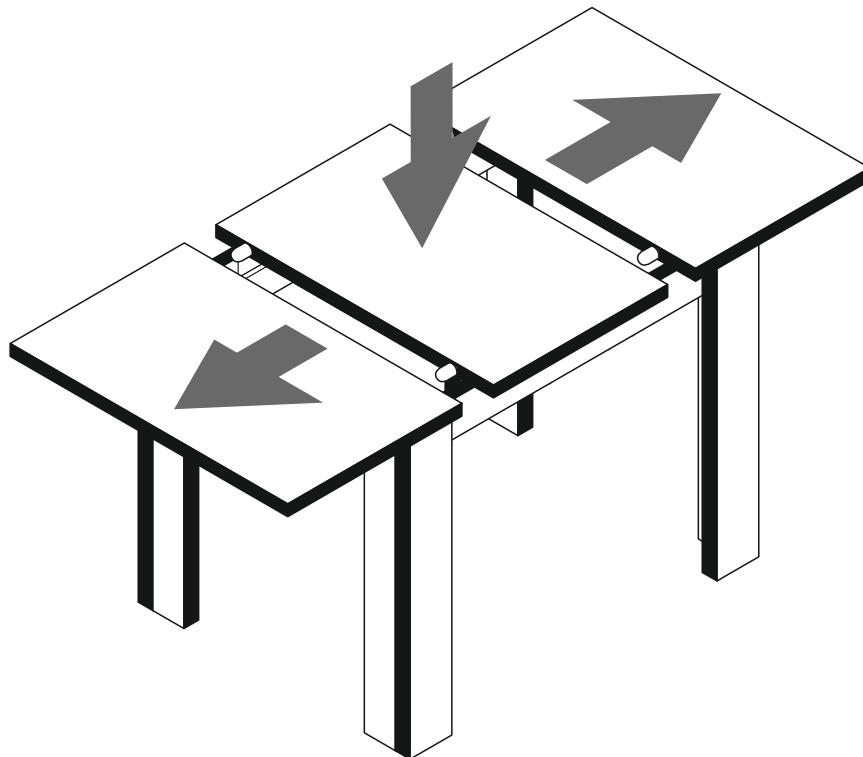

11

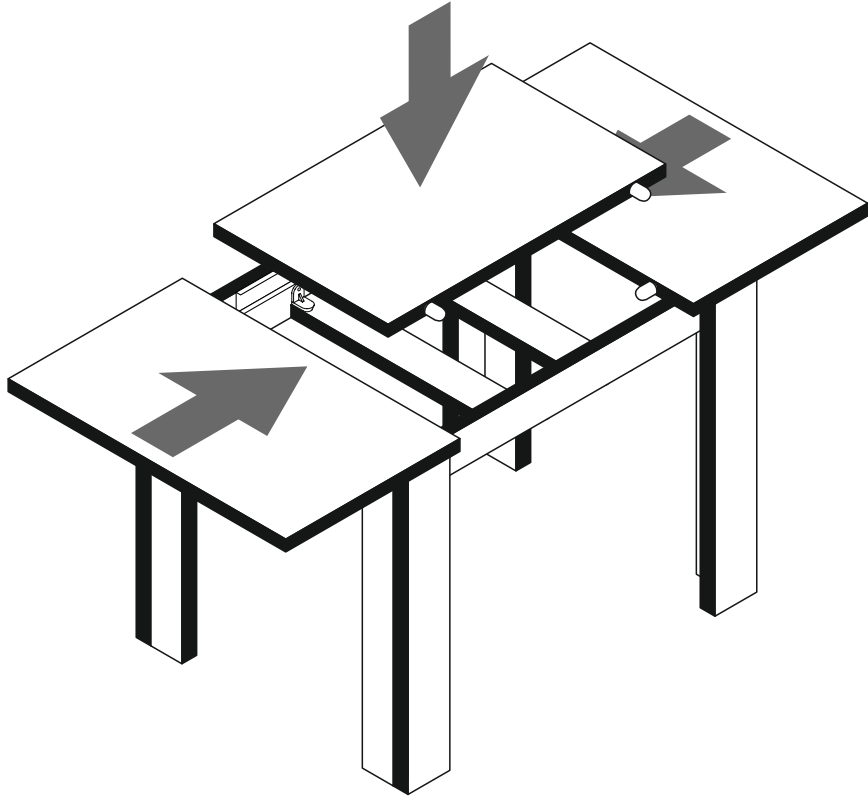

12

