

# DOPPIO

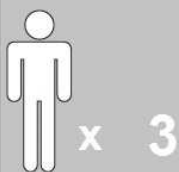
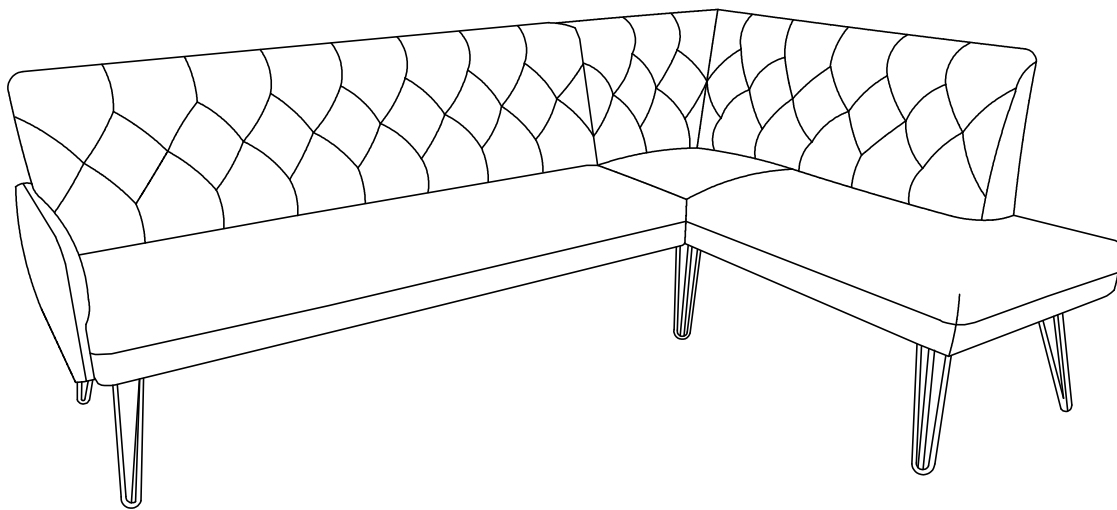

PL

INSTRUKCJA MONTAŻU  
INSTRUKCJA OBSŁUGI

D

MONTAGEANLEITUNG  
BEDIENUNGSANLEITUNG

TR

MONTAJ TALIMATI  
KULLANIM KLAVUZU

RO

INSTRUCȚIUNI DE INSTALARE  
INSTRUCȚIUNI DE UTILIZARE

FR

NOTICE DE MONTAGE  
MANUEL INSTRUCTIONS

HU

SZERELÉSI ÚTMUTATÁS  
KEZELÉSI UTASÍTÁS

GB

ASSEMBLY INSTRUCTIONS  
INSTRUCTION MANUAL

NL

HANDLEIDING VOOR DE MONTAGE  
GEBRUIKSAANWIJZING

RU

ИНСТРУКЦИЯ ПО МОНТАЖУ  
ИНСТРУКЦИЯ ПО ЭКСПЛУАТАЦИИ

IT

ISTRUZIONI DI MONTAGGIO  
MANUALE DI ISTRUZIONI



SK

MONTÁŽNY NÁVOD  
NÁVOD NA POUŽITIE

CZ

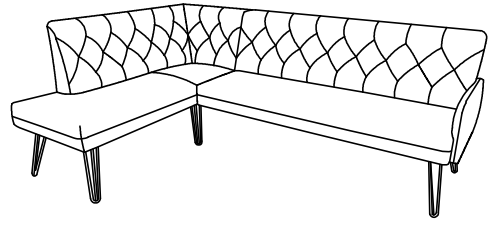
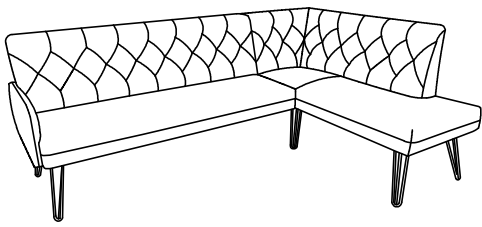
MONTÁŽNÍ NÁVOD  
NÁVOD K POUŽITÍ

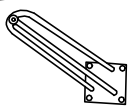
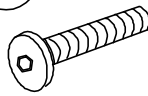

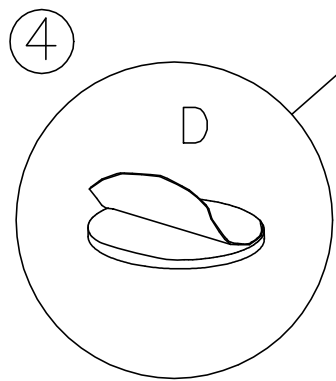
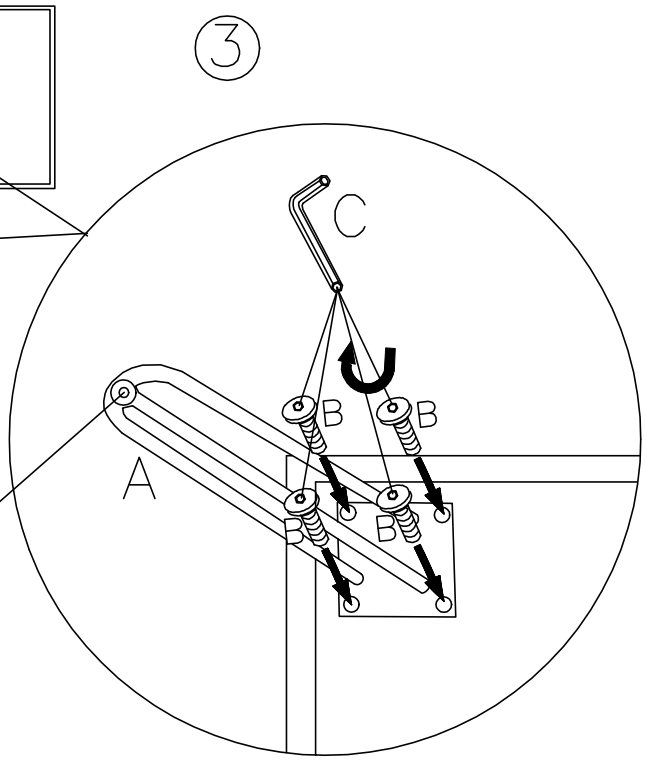
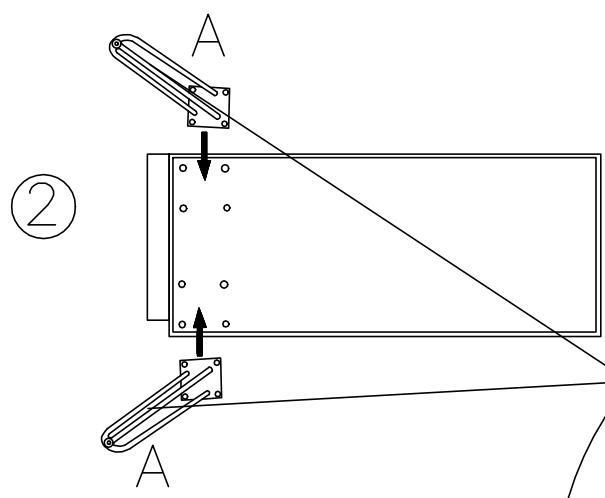
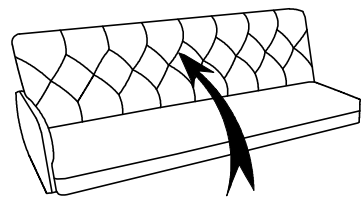

<b>(A)</b> 	<b>(B)</b>  M6 x 30	<b>(C)</b> 	<b>(D)</b> 
x 2	x 8	x 1	x 2

1

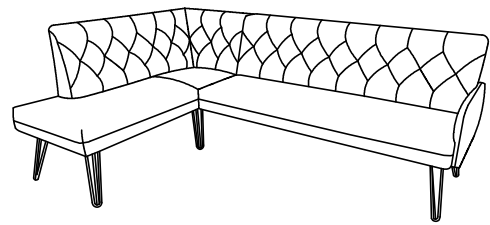
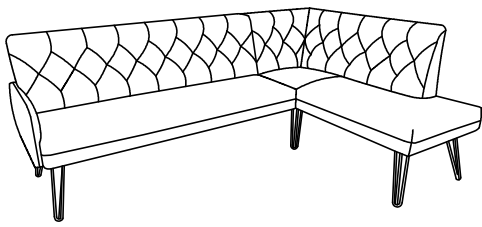

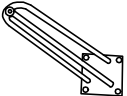
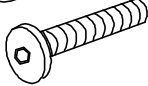

<b>(A)</b> 	<b>(B)</b>  M6 x 30	<b>(C)</b> 	<b>(D)</b> 
x 5	x 20	x 1	x 5

5

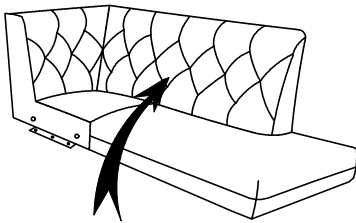

6

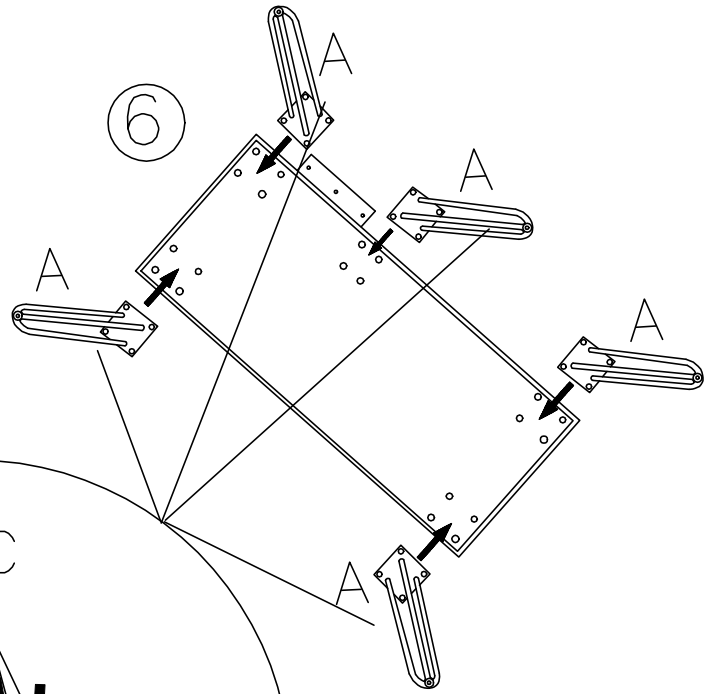

7

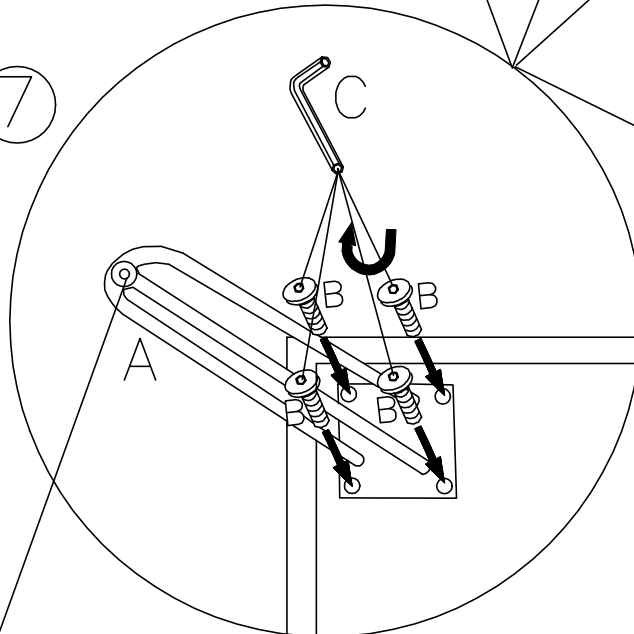

8

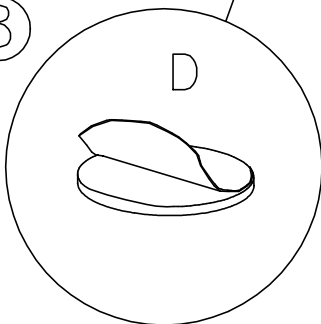

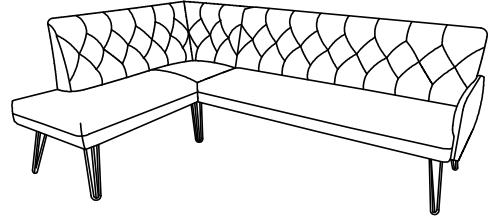
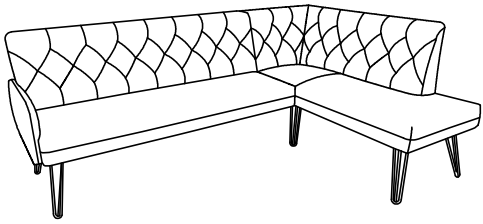

F

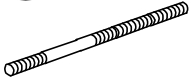

M8x110

x 2

9

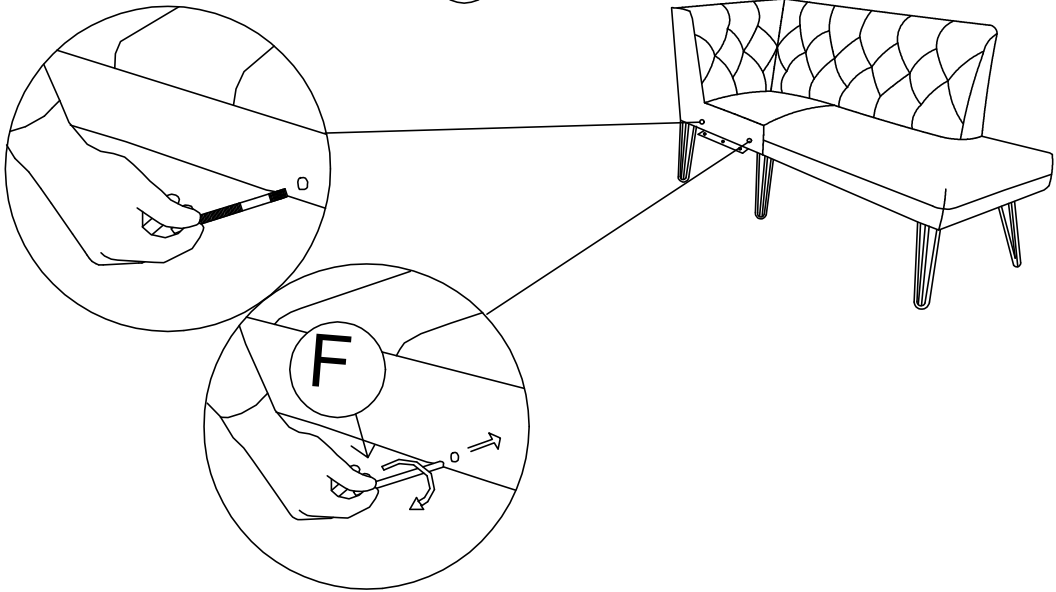

10

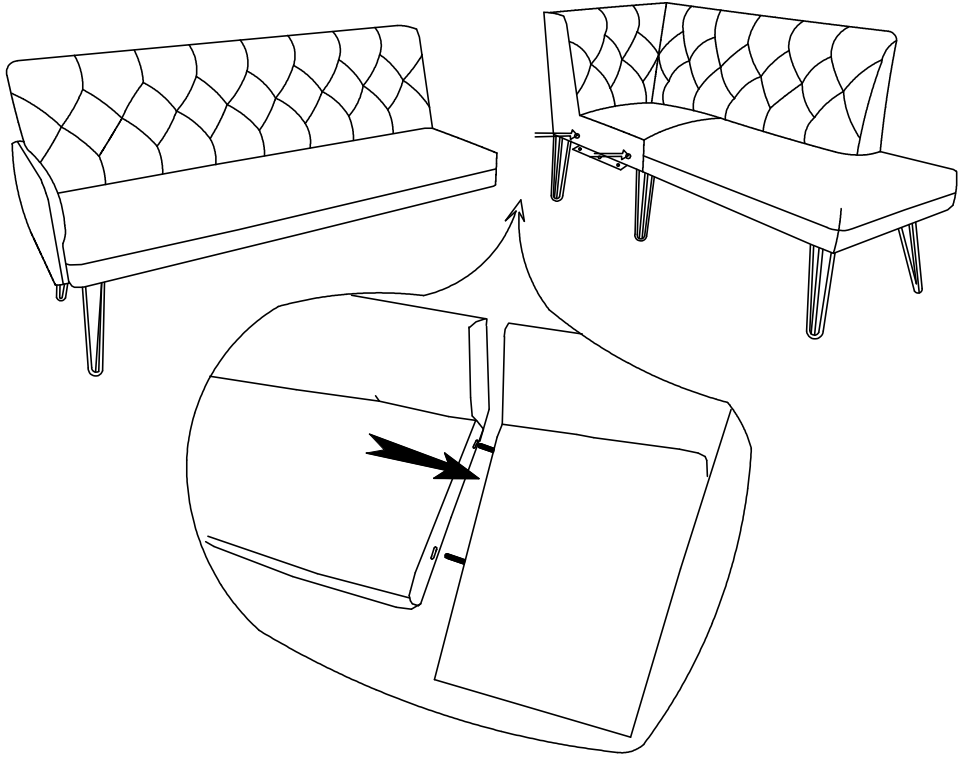

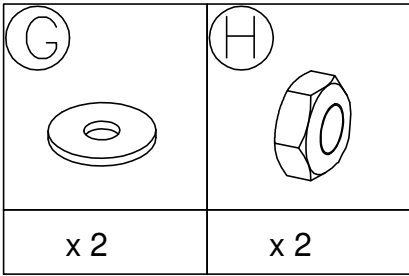
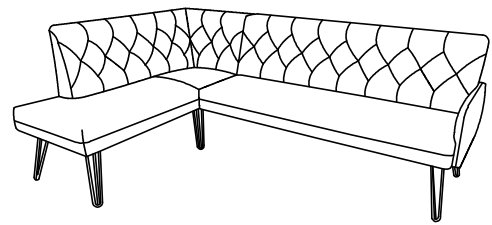
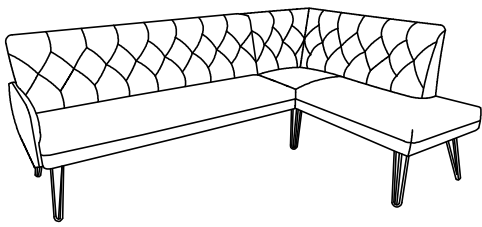

11

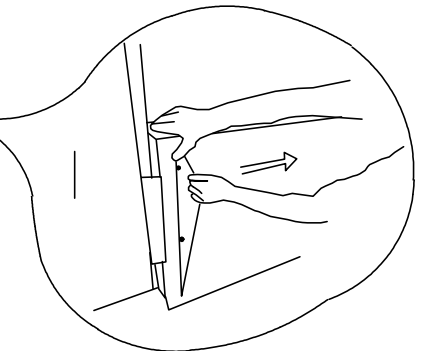
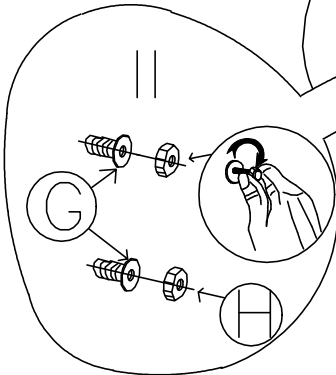
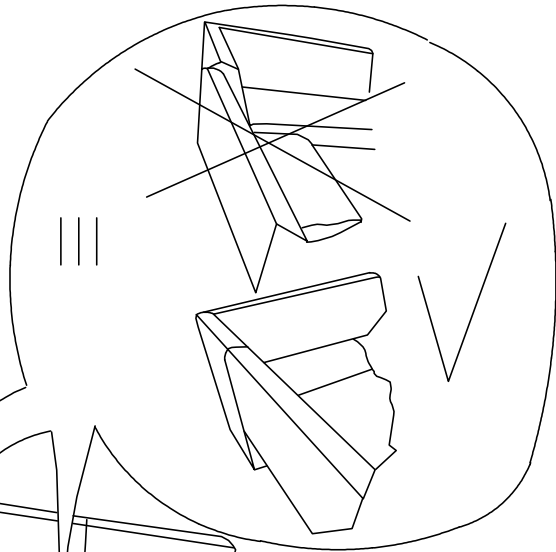
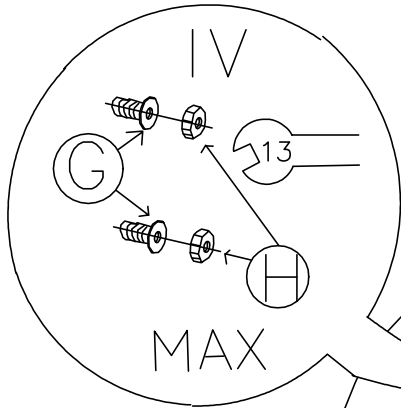



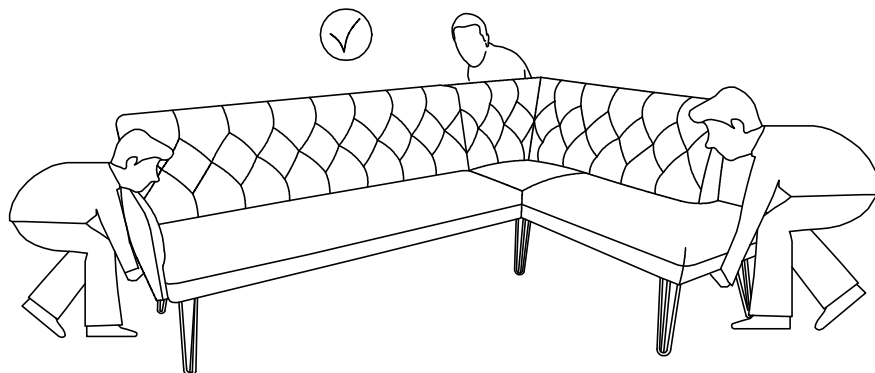
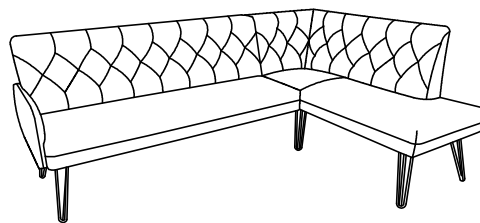

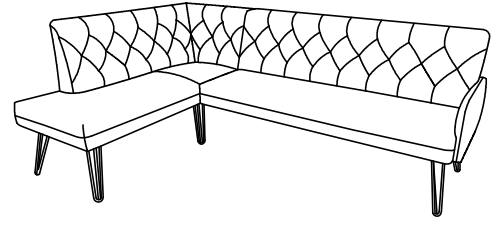
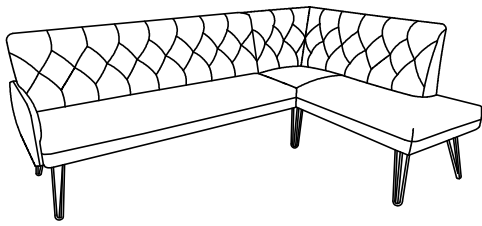

12

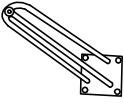
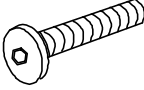

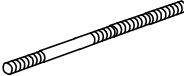
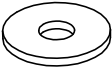

Service – Assistenza – Dienstverlening – Serwis – Servis – Szerviz – Сервисная служба

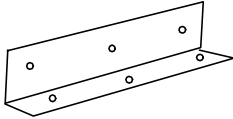
<p>(A)  .....</p>	<p>(B)  M6 x 30 .....</p>	<p>(C)  .....</p>
<p>(D)  .....</p>	<p>(E)  .....</p>	<p>(F)  M8x110 .....</p>
<p>(G)  .....</p>	<p>(H)  .....</p>	<p>(I)  .....</p>
<p>(J) .....</p>	<p>(K) .....</p>	<p>(L) .....</p>
<p>(M) .....</p>	<p>(N) .....</p>	<p>(O) .....</p>
<p>(P) .....</p>	<p>(R) .....</p>	<p>(S) .....</p>
<p>(T) .....</p>	<p>(U) .....</p>	<p>(V) .....</p>
<p>(W) .....</p>	<p>(X) .....</p>	<p>(Y) .....</p>
<p>(Z) .....</p>	<p>(AA) .....</p>	<p>(BB) .....</p>