

HOMESTORY

WOHNEN, WIE ES DIR GEFÄLLT.

POLSTER

BETRIEBSANLEITUNG



SO 4400

(Bitte aufbewahren) (Stand 10.06.2022)

setone
by Musterring

Nutzen Sie die Sicherheit einer großen Marke.



5 Jahre Garantie.

Auf set one Möbel ist Verlass.

Die Garantiebestimmungen, Gebrauchs- und Pflegeanweisungen sind im set one Möbel-Gütepass geregelt.



Service-Information

Sie erreichen uns per E-Mail oder über das Servicetelefon zu den üblichen Geschäftszeiten.



Individualität

Die set one Produktkennzeichnung belegt, dass Sie ein Unikat gekauft haben.



Pflege

Wir empfehlen Musterring Pflegeprodukte.

Lederpflege & Reinigung

Stoff-/ Mikrofaserpflege & Reinigung

Holzpflege und Sonderprodukte



Zu bestellen unter www.musterring-care.com oder unter der kostenlosen Beratungsnummer + 49 (0) 800 / 88 88 885.

Bei Fragen sprechen Sie uns bitte an; wir helfen Ihnen gerne weiter.

Zur Werterhaltung Ihrer Möbel

Unsere Pictogramme mit Erläuterungen

Aufbau

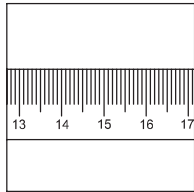

Maßangaben in den Preis- und Typenlisten beachten



Neu-/Umbauten sind vor der Lieferung abzuschließen

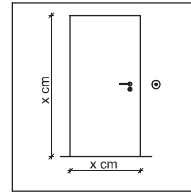

Stellflächen müssen eben und frei zugänglich sein

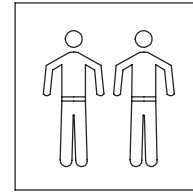

Lieferung und Montage nur durch Fachpersonal

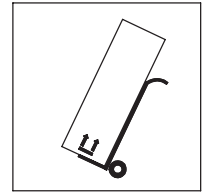

Verpackungsrichtlinien und Transporthinweise beachten

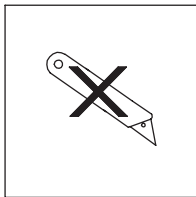

Nicht durch die Verpackung schneiden

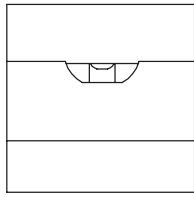

Genaueres Ausrichten mit der Wasserwaage erforderlich

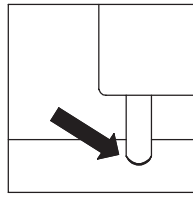

Möbelfüße/-gleiter sind den Fußböden anzupassen

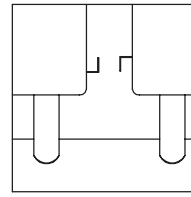

Elementverbindungen nach Herstellervorgaben

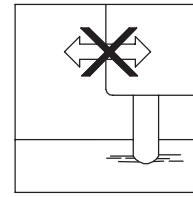

Montagezustand nicht ohne Demontage verändern

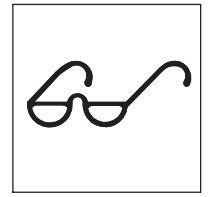

Abnahme durch Sicht- und Funktionsprüfung

Betrieb

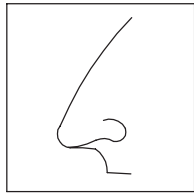

Neumöbelgeruch ist material- und warentypisch

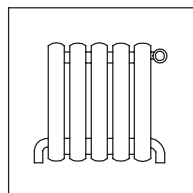

Mindestabstand zu Heizquellen beachten

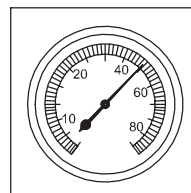

Empfohlenes Raumklima Ø 45-55% Luftfeuchte

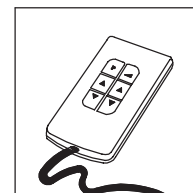

Betriebsanleitung beachten

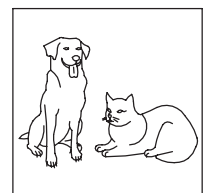

Haustiere schaden Bezügen bzw. Oberflächen

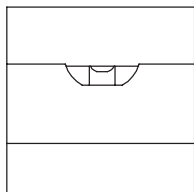

Genaueres Ausrichten mit der Wasserwaage erforderlich

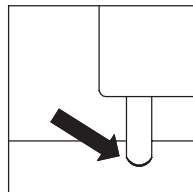

Möbelfüße/-gleiter sind den Fußböden anzupassen

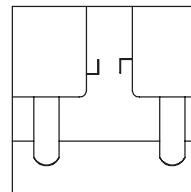

Elementverbindungen nach Herstellervorgaben

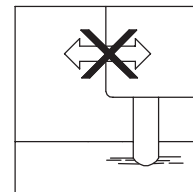

Montagezustand nicht ohne Demontage verändern

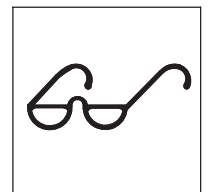

Abnahme durch Sicht- und Funktionsprüfung

Wartung

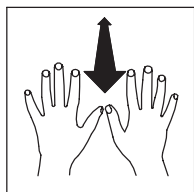

Polsterbezüge regelmäßig aufklöpfen

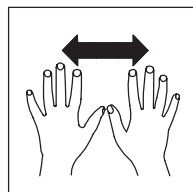

Polsterbezüge regelmäßig glätten

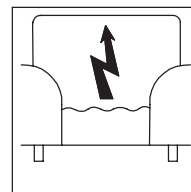

Statische Aufladung der Bezüge möglich

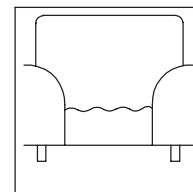

Legerer Polsteraufbau neigt zur Wellenbildung

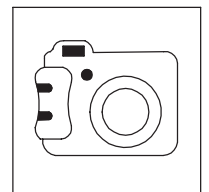

Im Schadenfall Foto: Gesamt-, Detailansicht

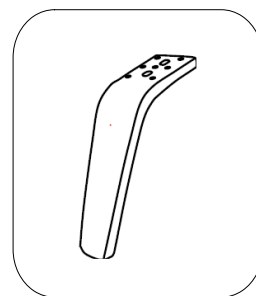
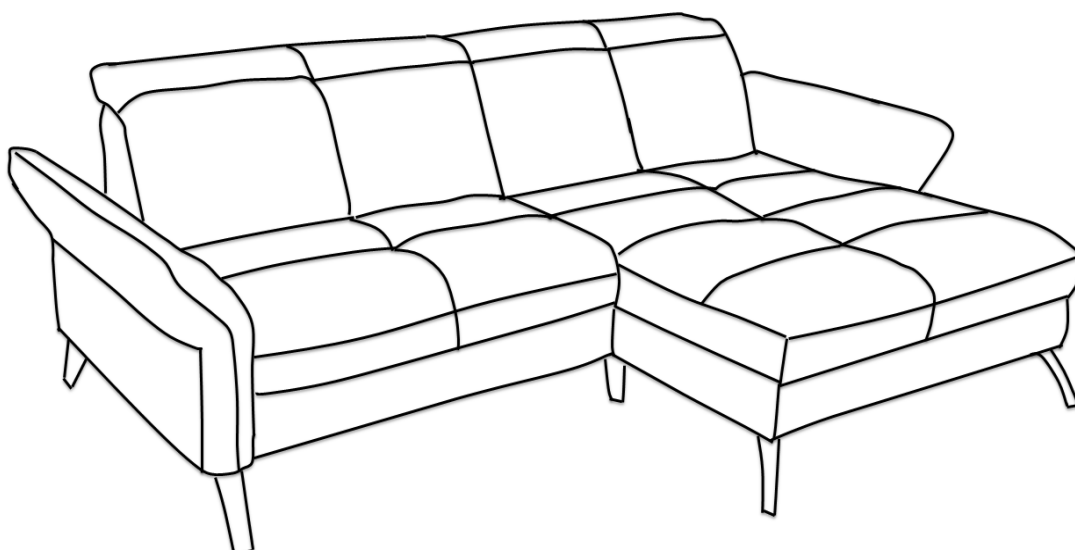
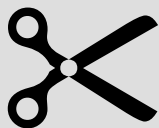
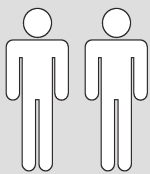

SO 4400

V.2022

D

MONTAGEANLEITUNG
BEDIENUNGSANLEITUNG

NL

HANDLEIDING VOOR DE
MONTAGE
GEBRUIKSAANWIJZING

TR

MONTAJ TALIMATI
KULLANIM
KLAVUZU

RO

INSTRUCȚIUNI DE INSTALARE
INSTRUCȚIUNI DE UTILIZARE

FR

NOTICE DE MONTAGE
MANUEL INSTRUCTIONS

HU

KÖZGYŰLÉS UTASÍTÁSOK
KEZELÉSI UTASÍTÁS

SI

NAVODILA ZA MONTAŽO
NAVODILA ZA UPORABO

ES

INSTRUCCIONES DE MONTAJE
MANUAL DEL USUARIO

GB

ASSEMBLY
INSTRUCTIONS
INSTRUCTION MANUAL

PL

INSTRUKCJA
MONTAŻU
INSTRUKCJA OBSŁUGI

RU

ИНСТРУКЦИЯ ПО МОНТАЖУ
ИНСТРУКЦИЯ ПО
ЭКСПЛУАТАЦИИ

IT

ISTRUZIONI DI
MONTAGGIO
MANUALE DI ISTRUZIONI

SK

MONTÁŽNY NÁVOD
NÁVOD NA
POUŽITIE

CZ

MONTÁŽNÍ
NÁVOD
NÁVOD K POUŽITÍ

PT

INSTRUÇÕES DE
MONTAGEM
MANUAL DO USUÁRIO

HR

UPUTE ZA MONTAŽU
UPUTE ZA UPOTREBU

Service · Dienstverlening · Serwis · Servis · Сервисная служба · Serviciu · Services
· Servizio · Servisný list · Szolgáltatás · Servisní list

Name · Naam · Nazwa · Іsím · Название · Nume · Nome · Názov ·
Názov · Název · Neve

SO 4400

Тип · Type · Tip · Тип · Típo · Típus

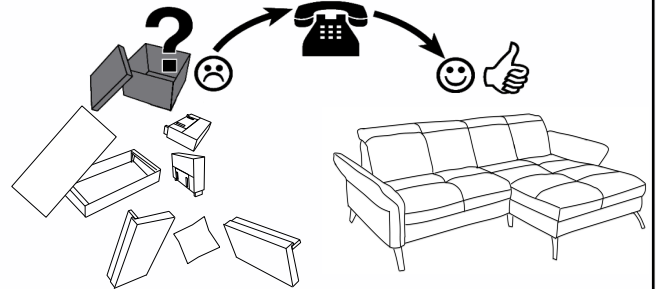
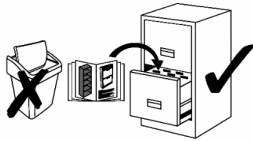

	A	B	C	D	G	H	I
		 M6x25		 M6x50			 4L
 li/re	2	8	2	8	-	-	1
 li/re	4	16	-	-	1	1	
	1	4	-	-	3	-	

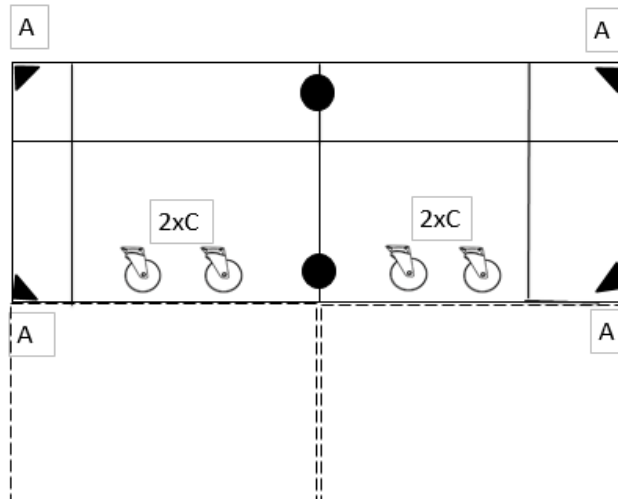

SO 4400

Service · Dienstverlening · Serwis · Servis · Сервисная служба · Serviciu · Services
 ·Servizio · Servisný list · Szolgáltatás · Servisní list

Name · Naam · Nazwa · İsim · Название · Nume · Nome · Názov ·
 Názov · Název · Neve

SO 4400

Typ · Type · Tip · Тип · Tipo · Típus

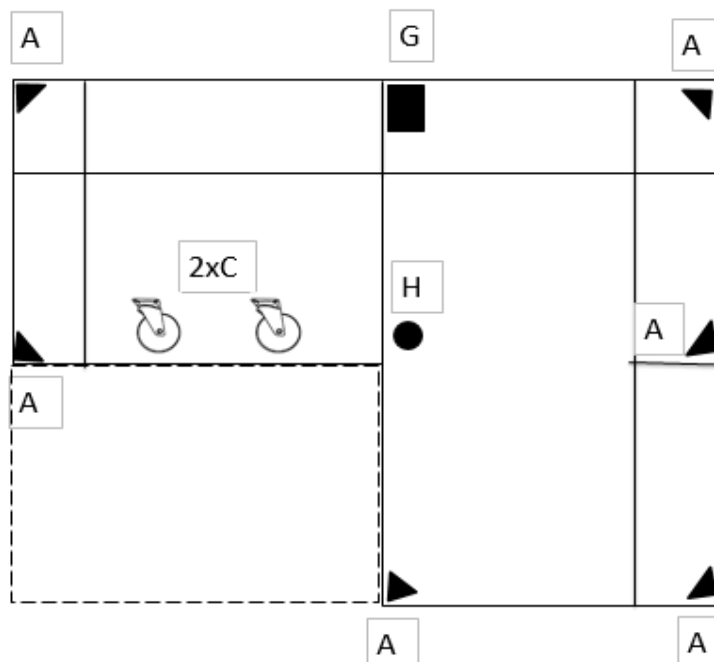
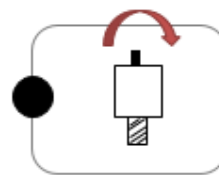
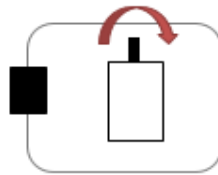
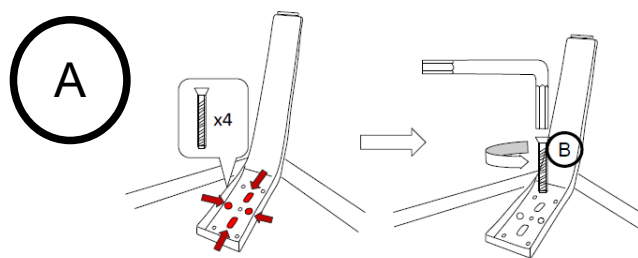
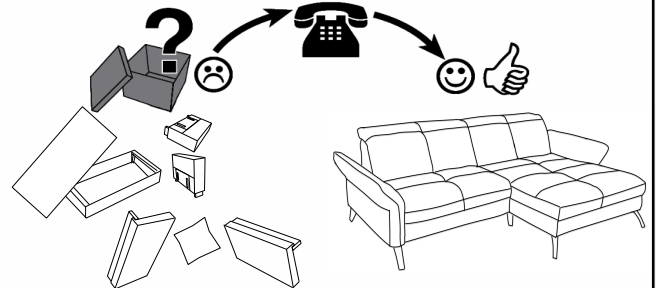
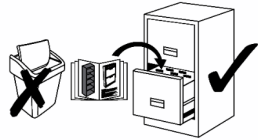

SO 4400





Service · Dienstverlening · Serwis · Servis · Сервисная служба · Serviciu · Services
 ·Servizio · Servisný list · Szolgáltatás · Servisní list

Name · Naam · Nazwa · Ísim · Название · Nume · Nome · Názov ·
 Názov · Název · Neve

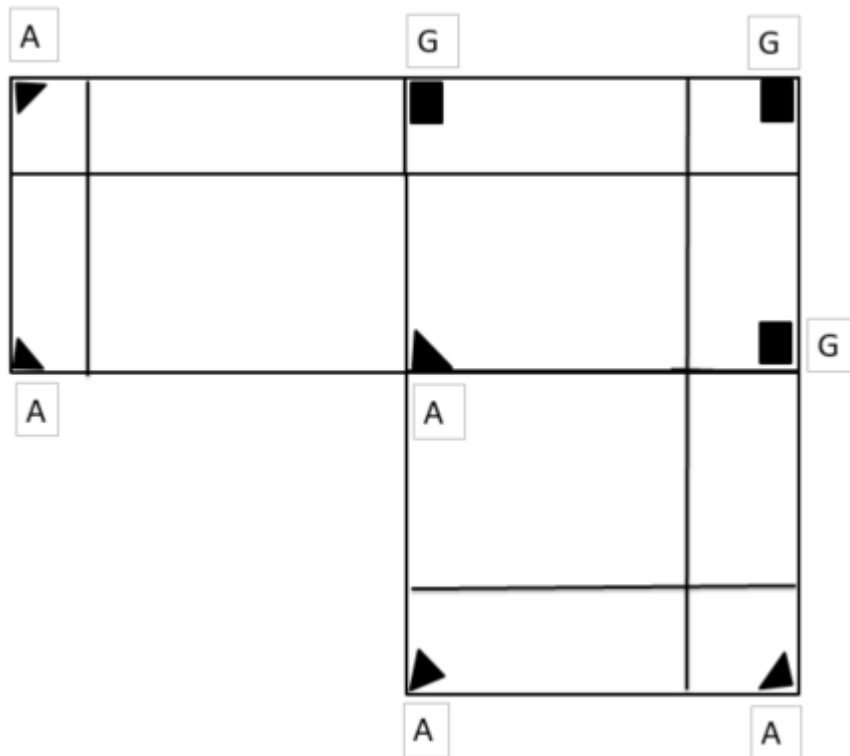
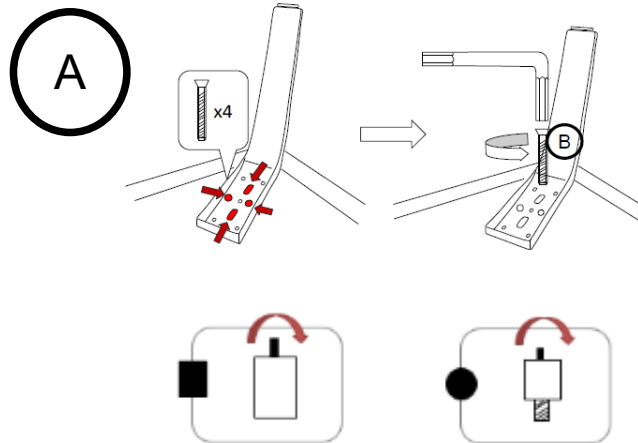
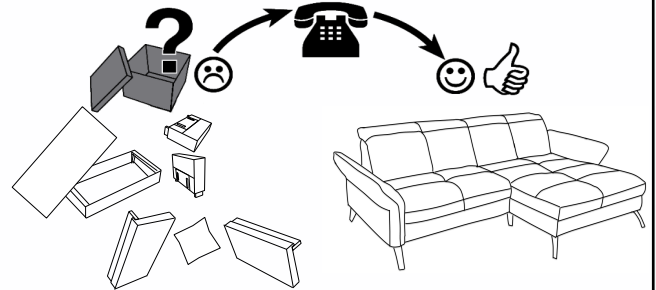
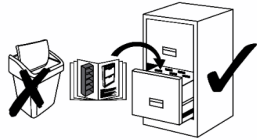
SO 4400

Typ · Type · Tip · Тип · Tipo · Típus



A	B	H	I
	 M6x25		 4L

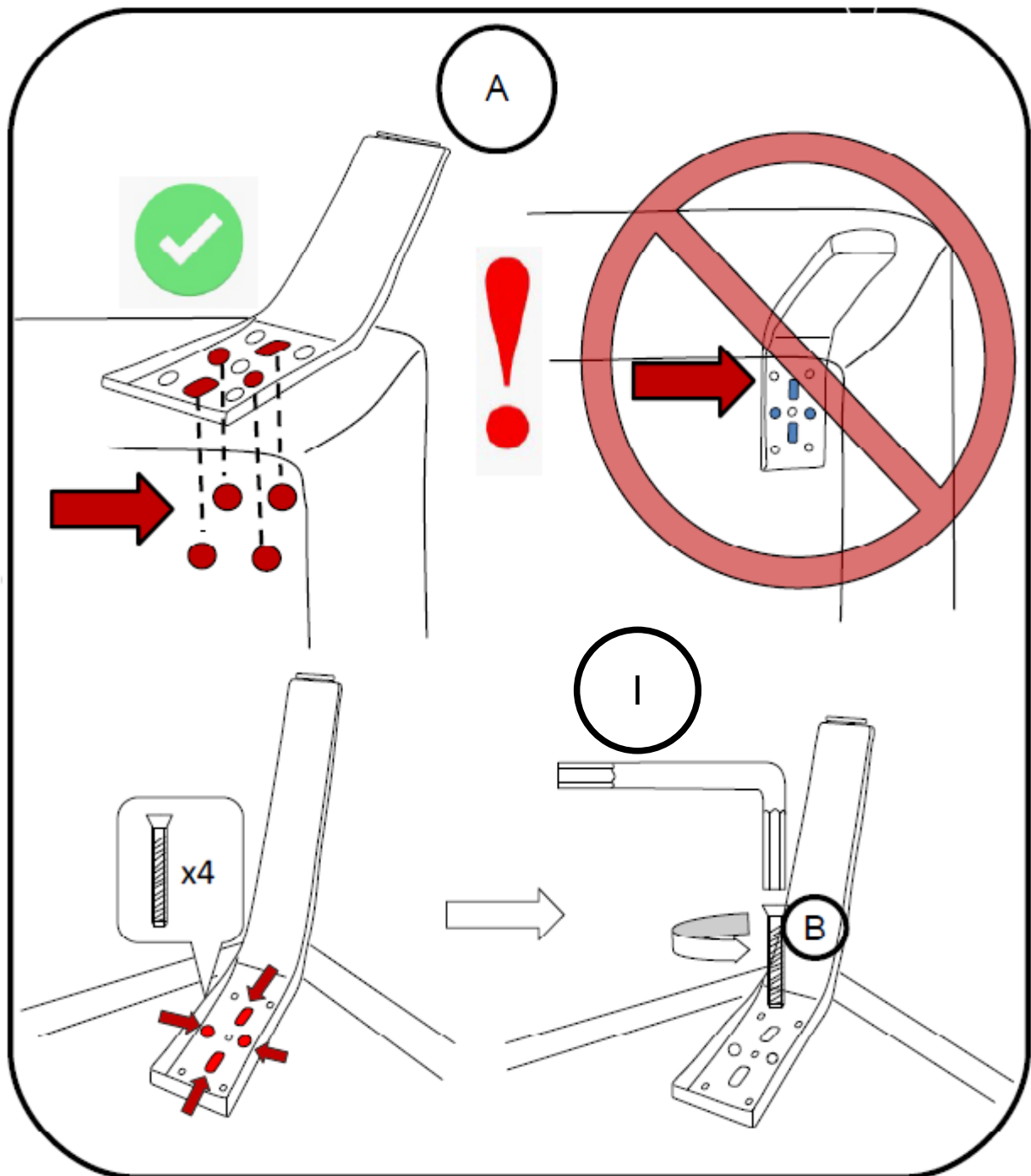

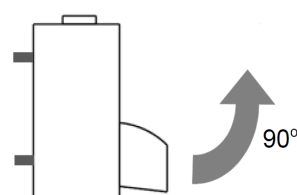
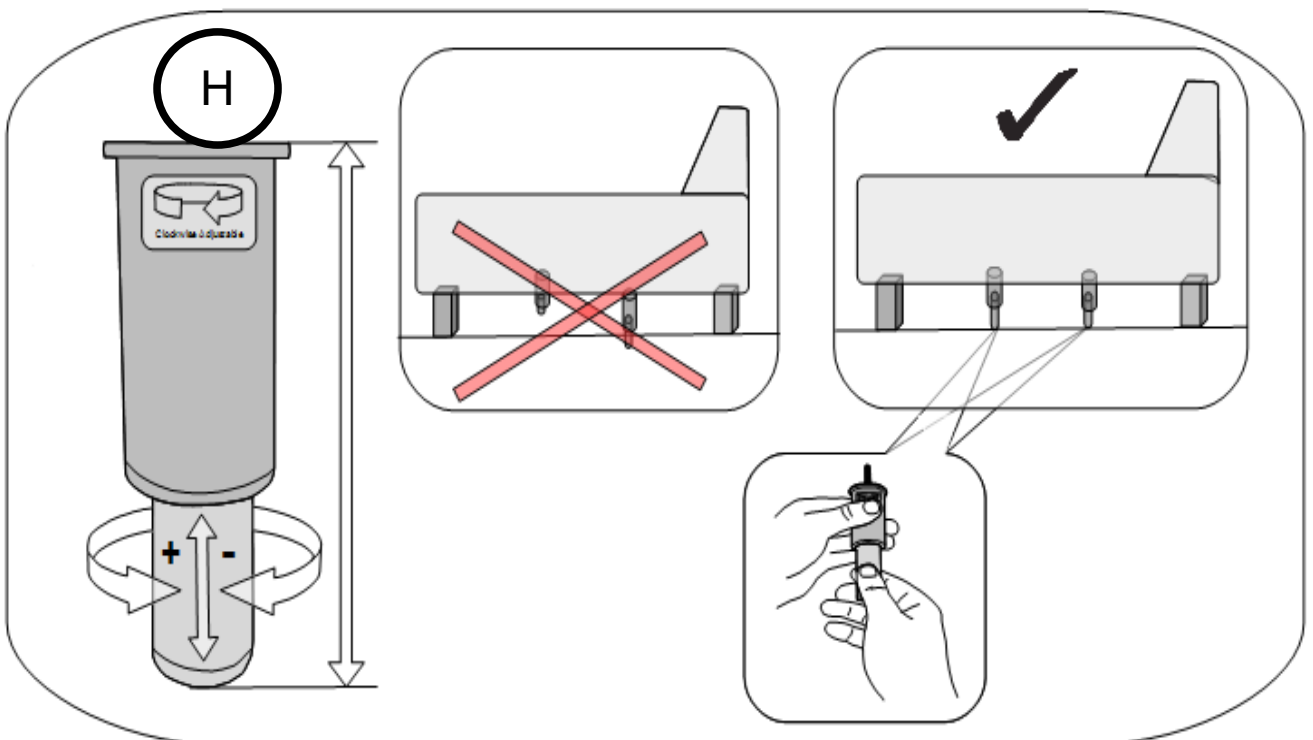
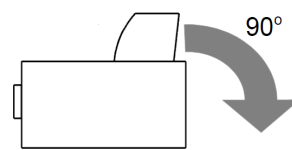
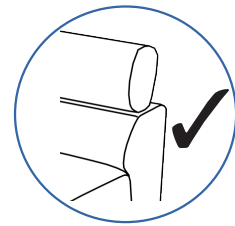
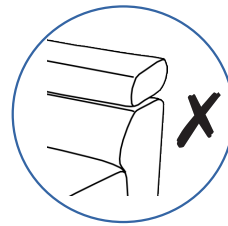
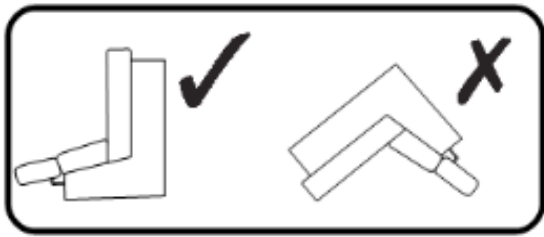

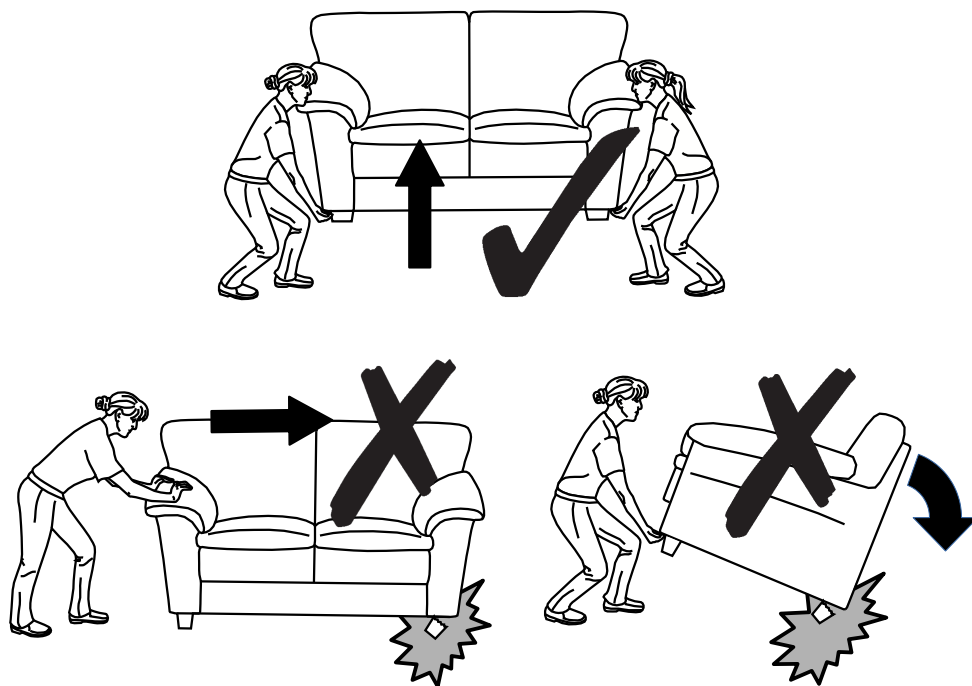
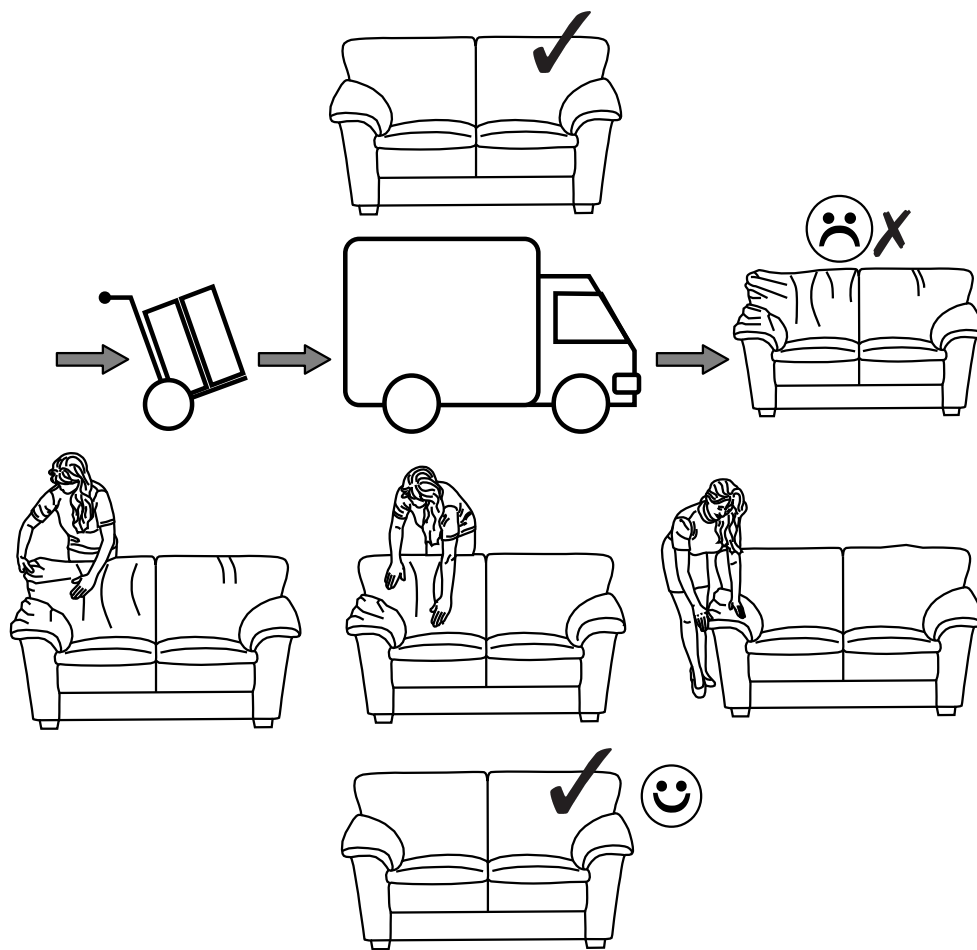

Die Piktogramme sind schematisch und können von der Wirklichkeit abweichen !

(A)

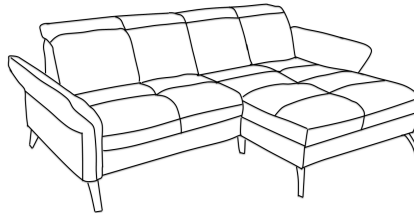

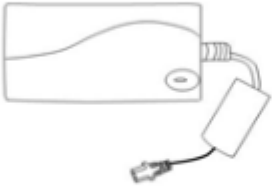
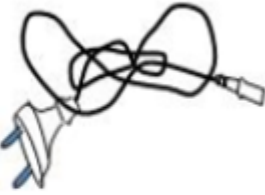
✓	V		Y
	 <p>Input: 100-240V~,50/60Hz,1.6A</p> <p>Output: 29V=2A</p> <p>1X</p>		 <p>~ 1,2 m</p> <p>1X</p>

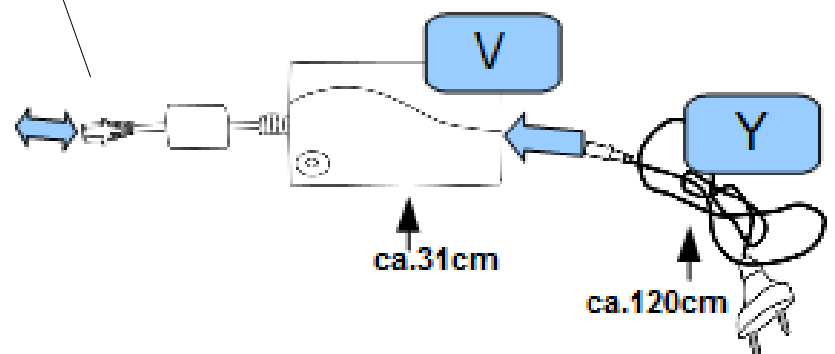
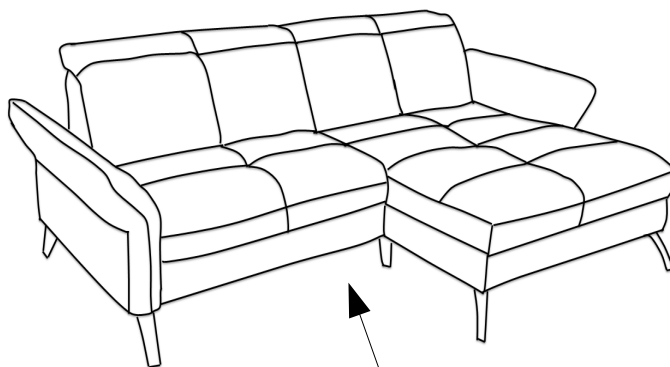

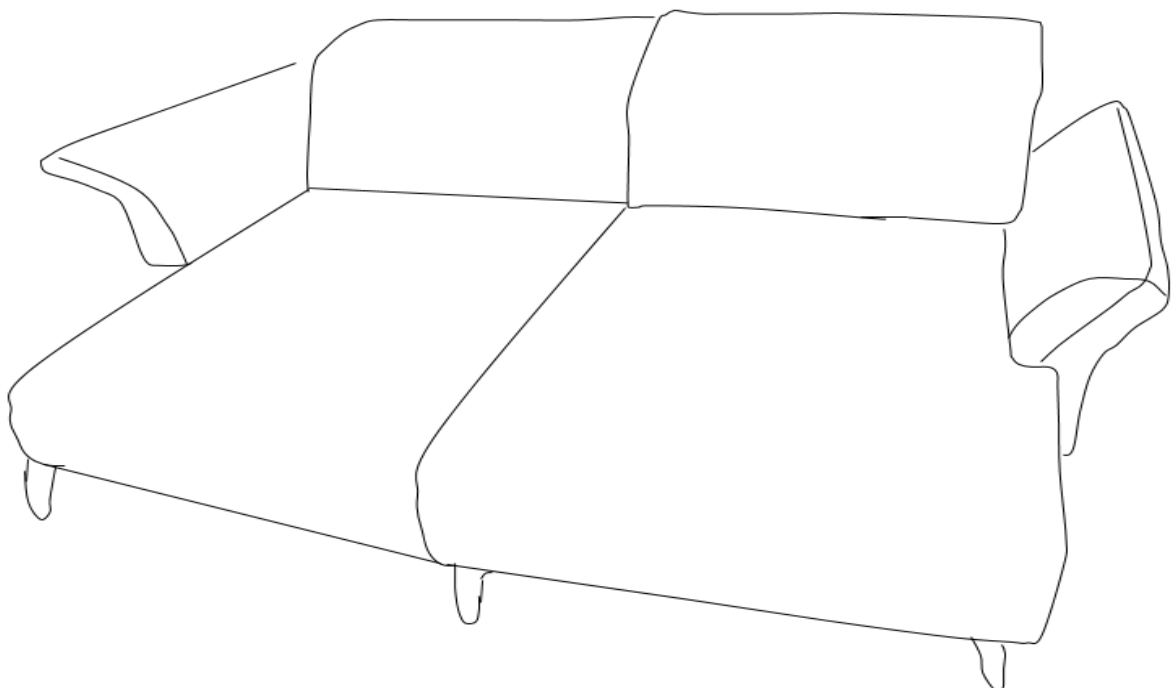
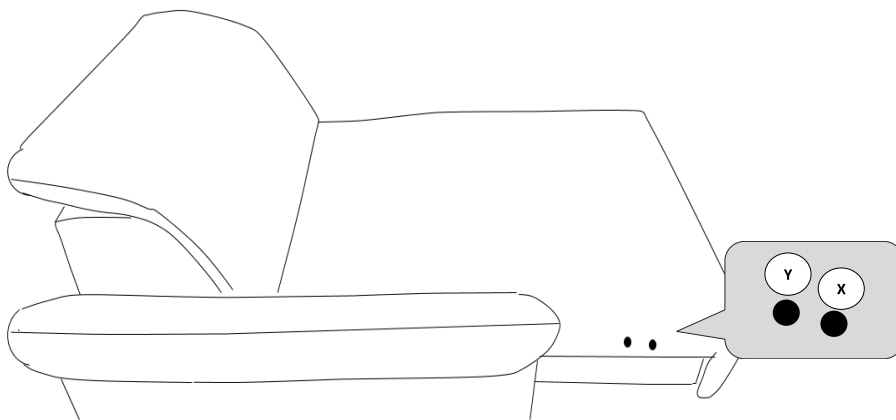
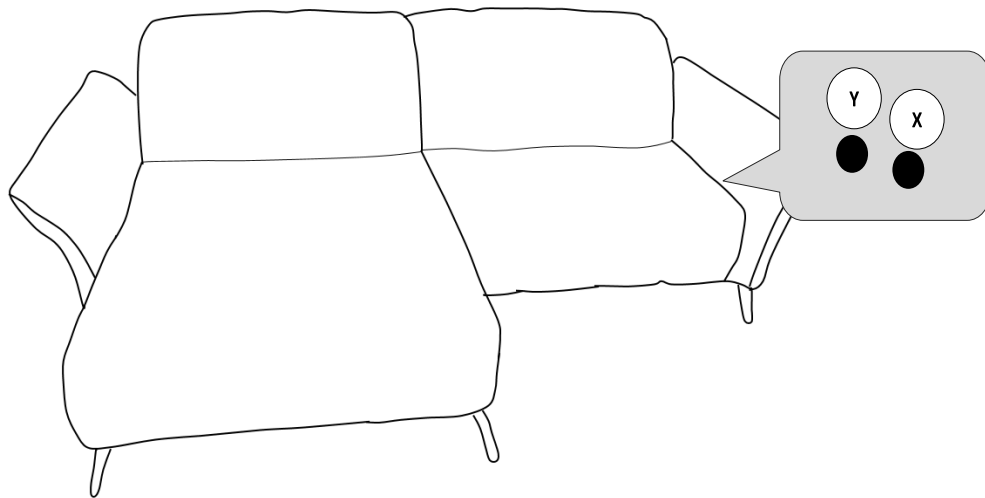

A

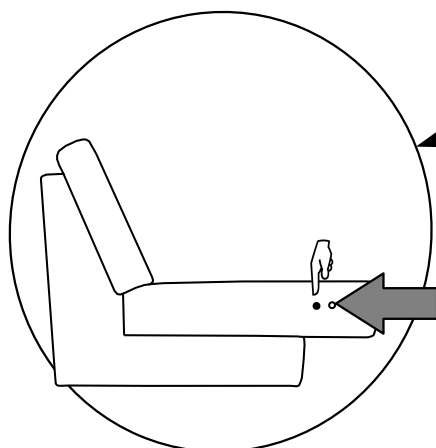
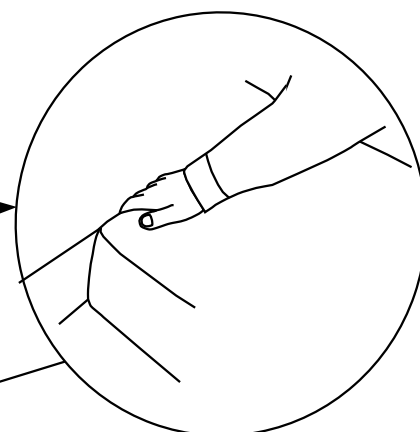
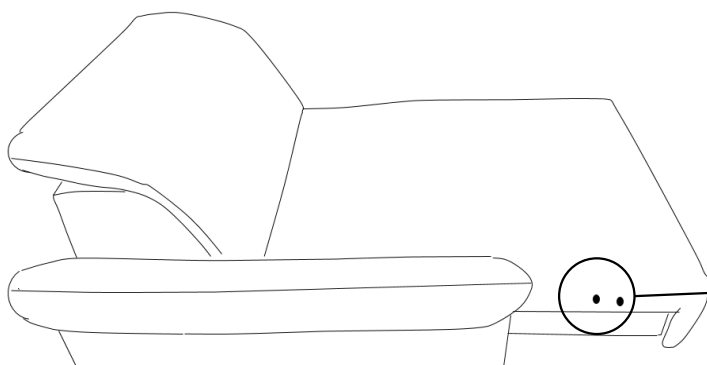
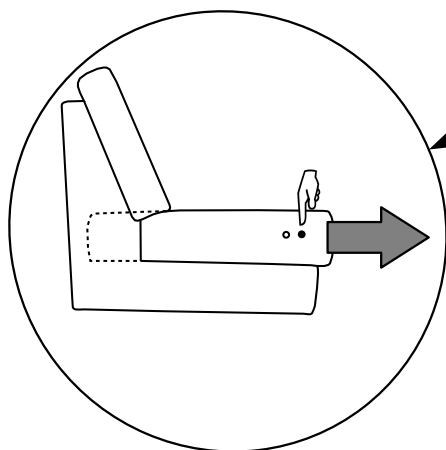
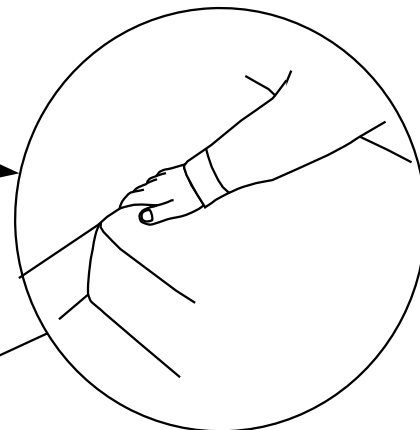
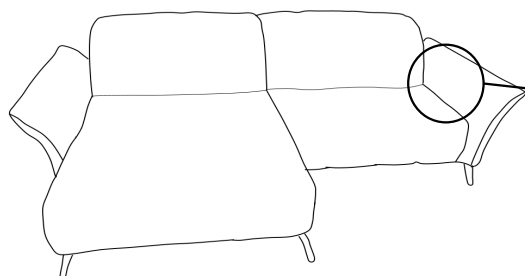
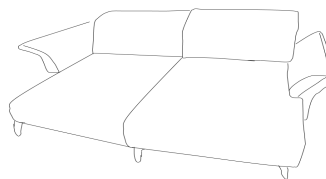
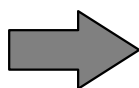
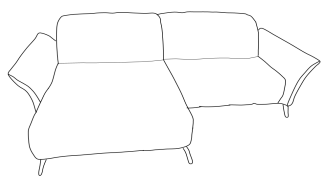

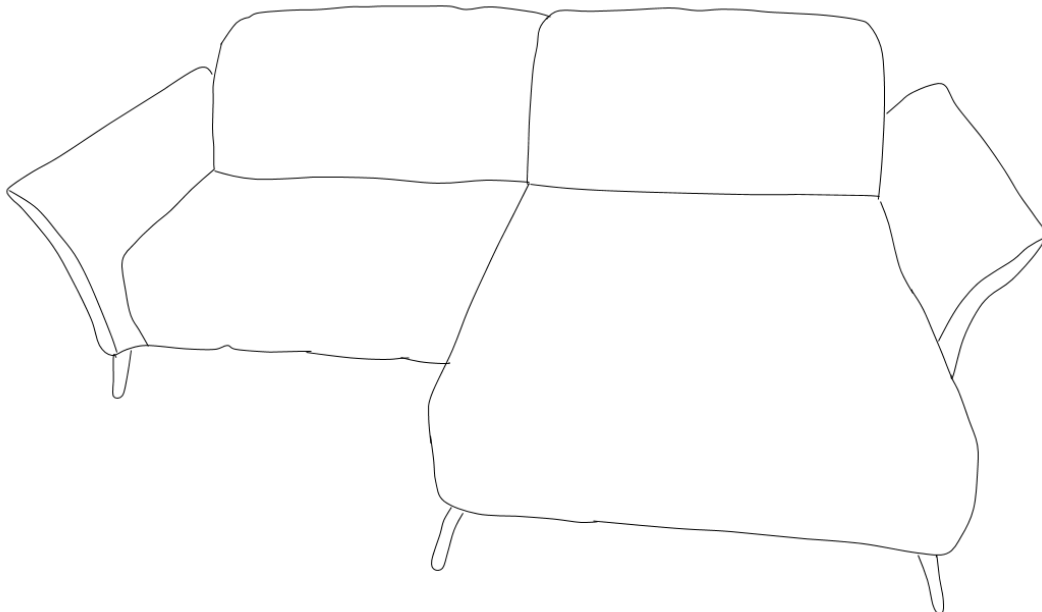
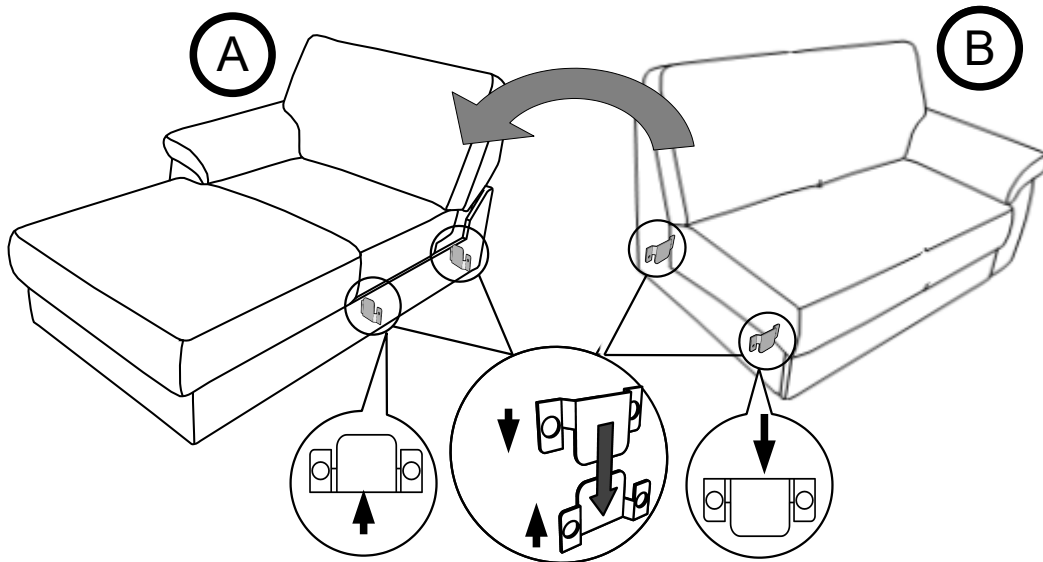
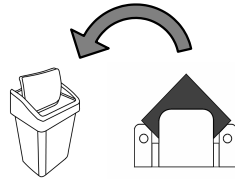

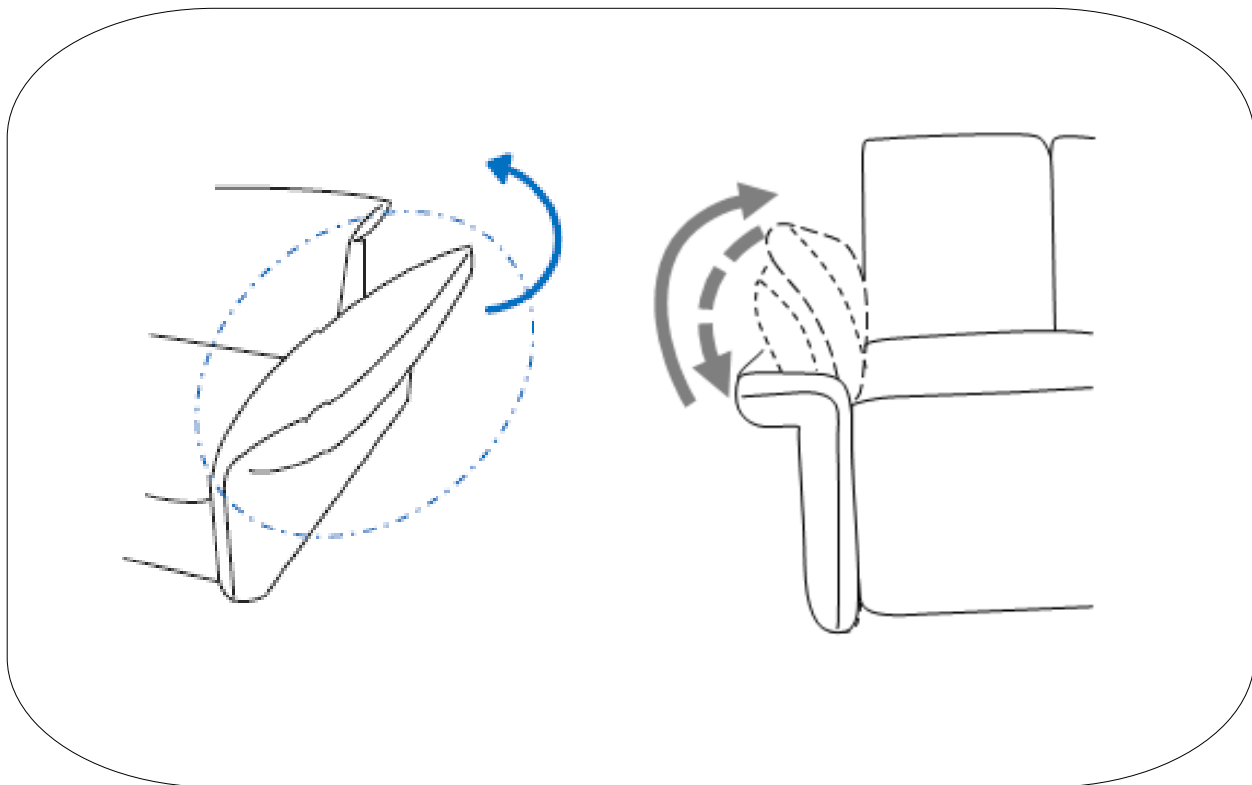
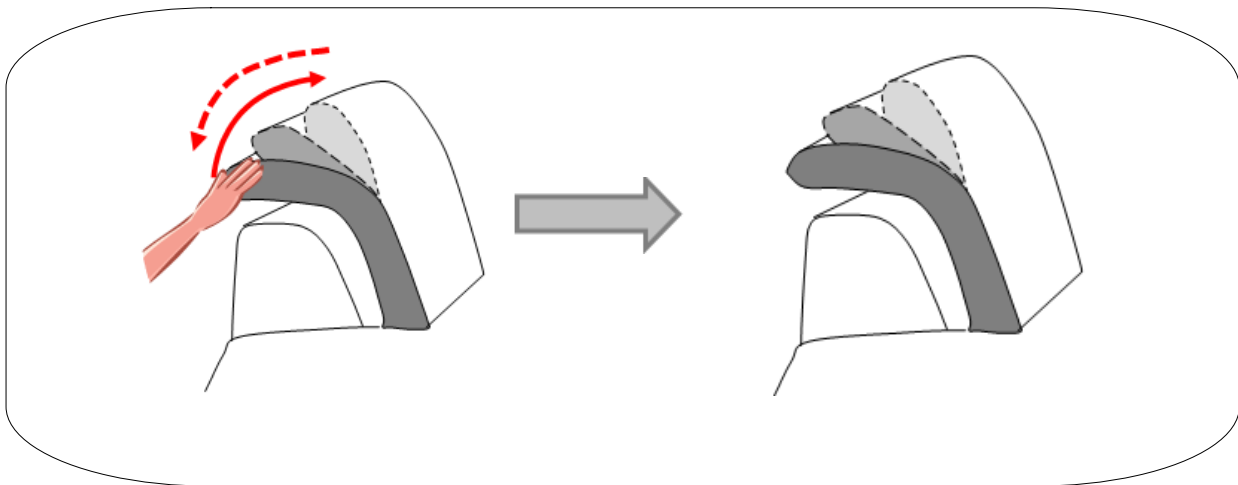
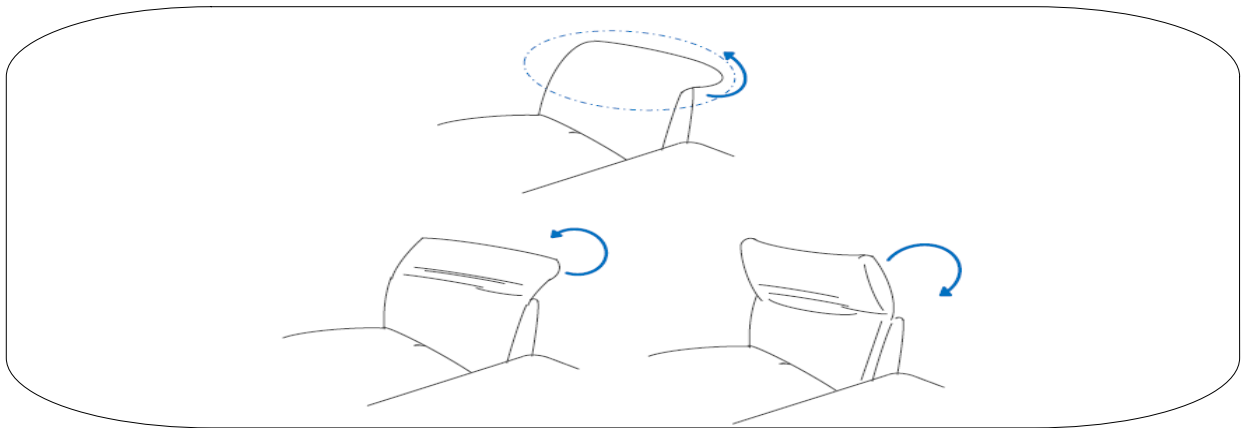

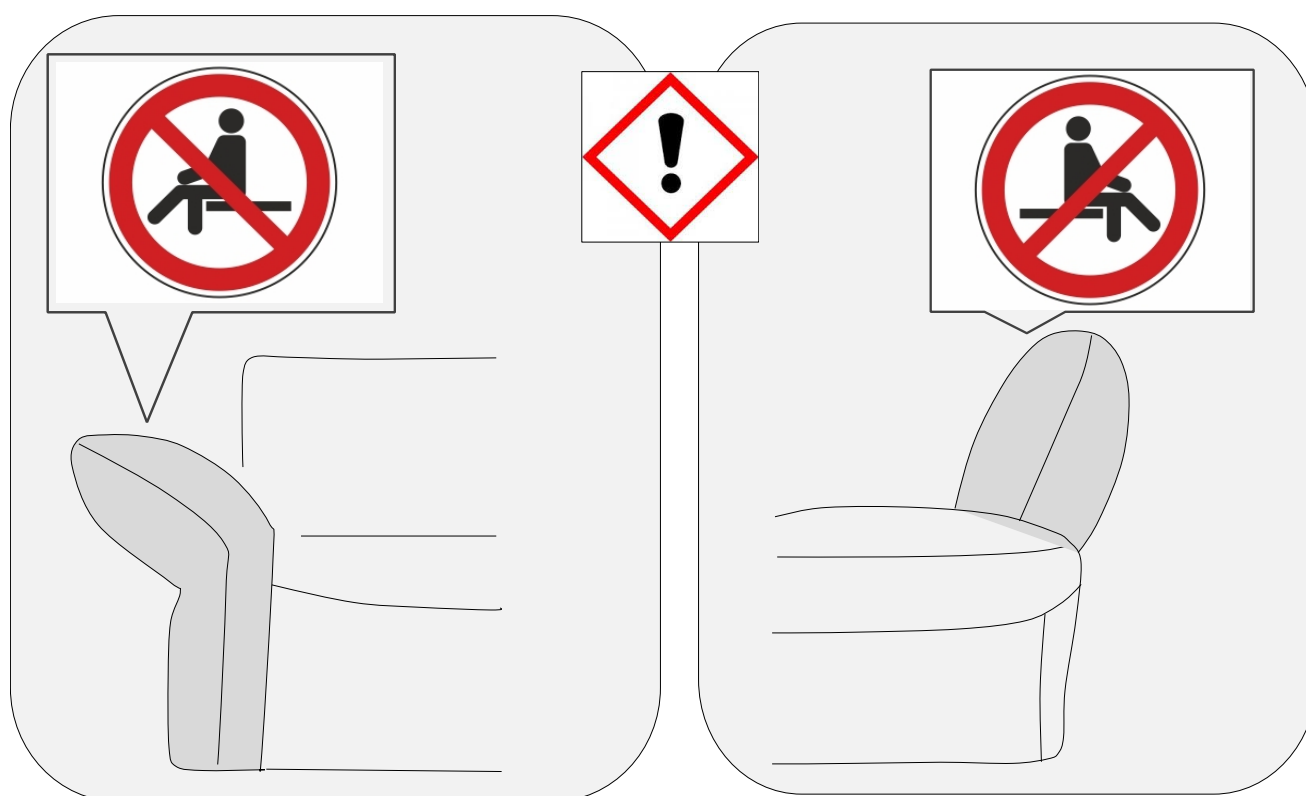
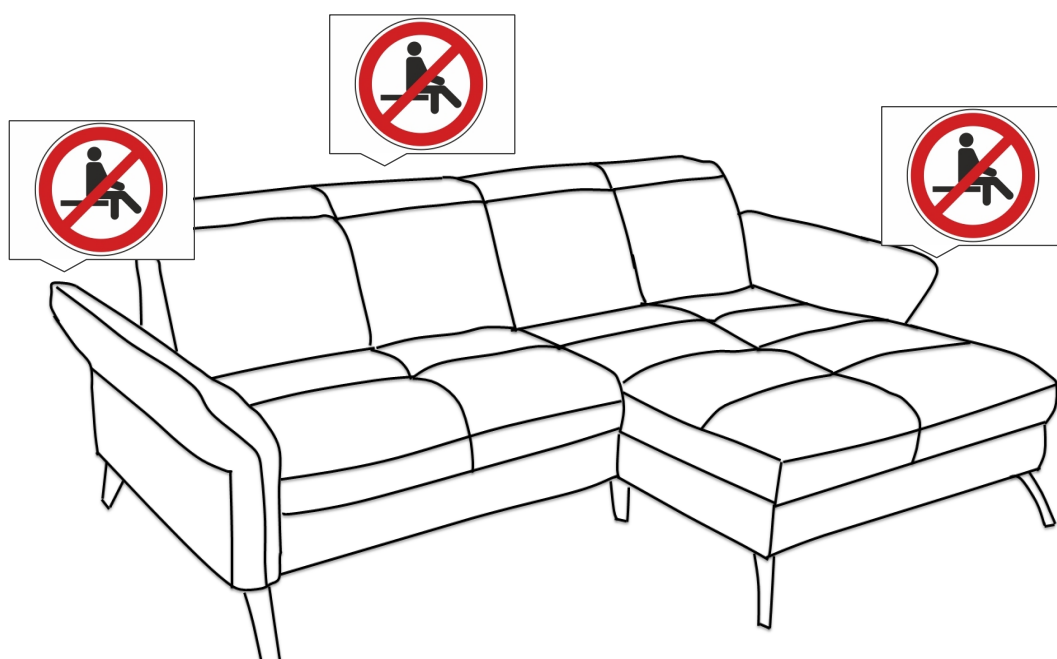

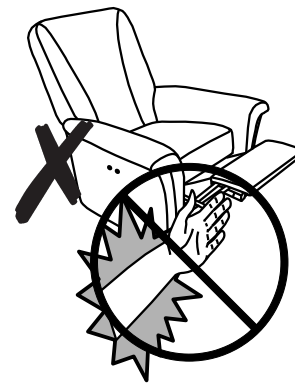
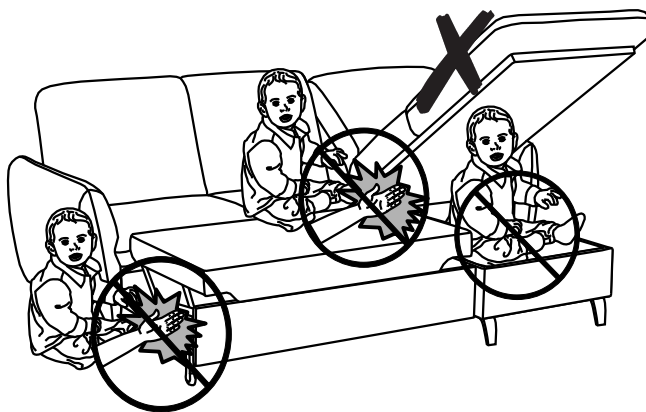
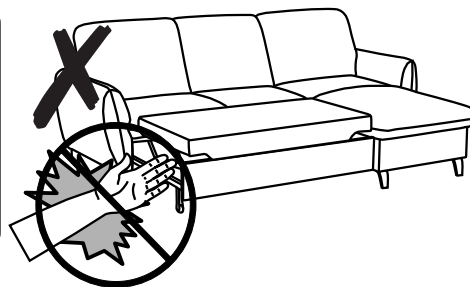
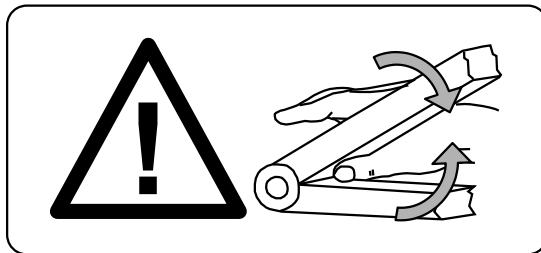
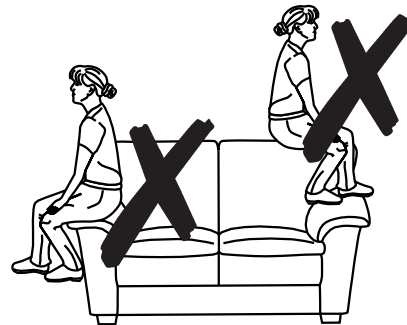
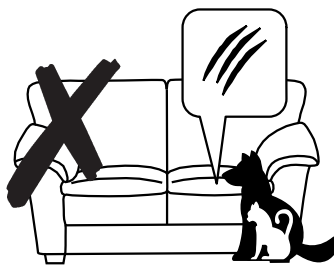
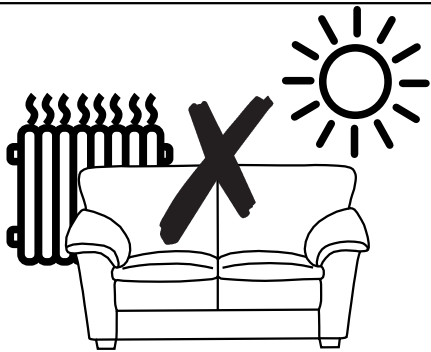

Copyright 2019/2020 by
Mustering Trading GmbH Co.KG
D – 33378 Rheda-Wiedenbrück

Bei nicht vorschriftsmäßiger und/ oder
nicht fachmännischer Montage wird bei
Personen- und / oder Sachschäden keinerlei
Haftung übernommen.