

Mette 3020

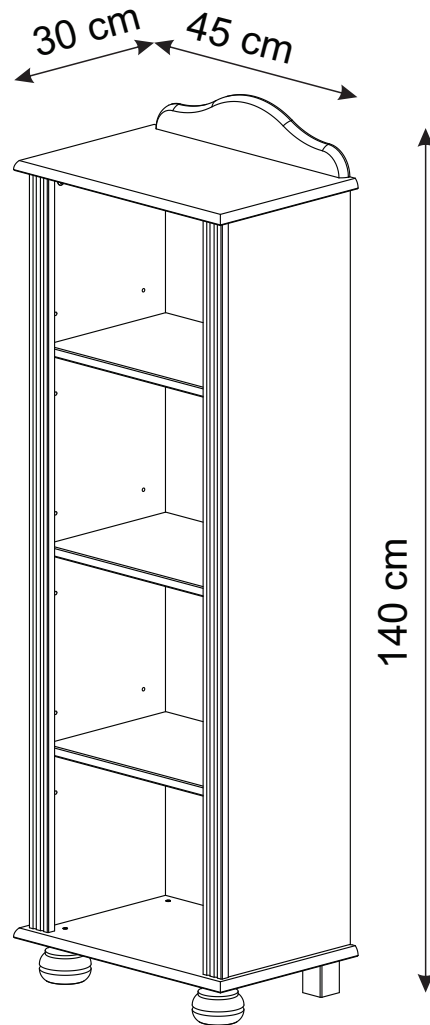

D Montageanleitung
3020

FR Notice de montage
3020

NL Handleiding voor de montage
3020

CZ Montážní návod
3020

HU Szerelési útmutató
3020

TR Montaj talimatı
3020

GB Assembly instructions
3020

IT Istruzioni di montaggio
3020

PL Instrukcja montażu
3020

SK Návod na montáž
3020

RO Instrucțiuni de montaj
3020

RU Инструкция по монтажу
3020

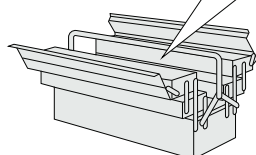
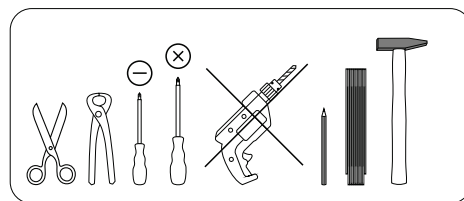
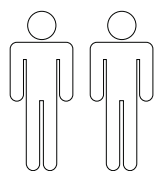









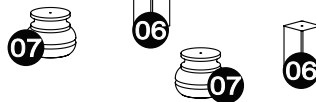
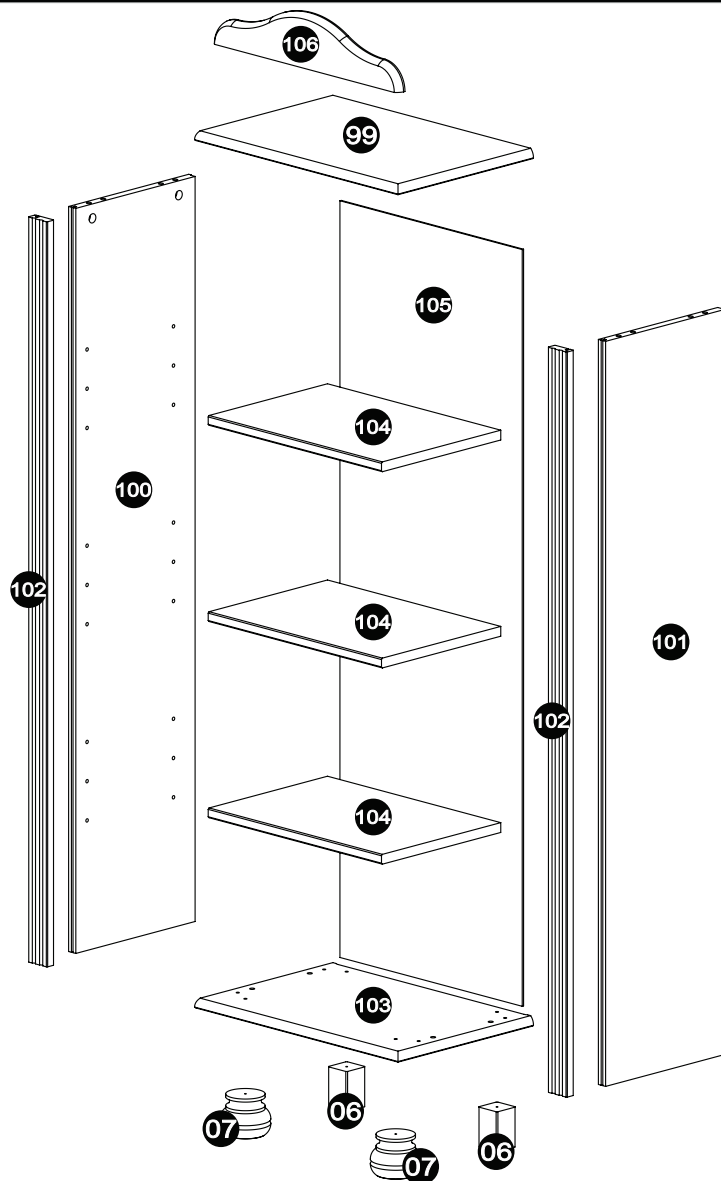
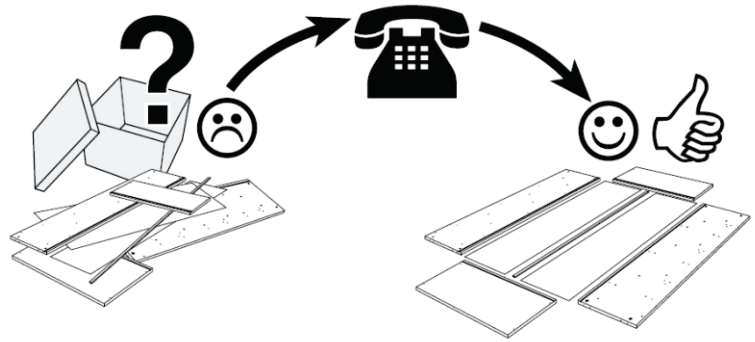
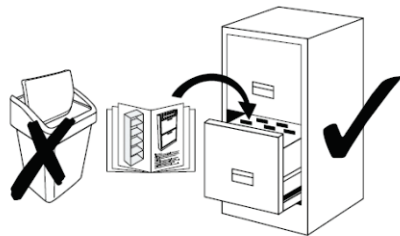





**Service • Assistenza • Dienstverlening • Serwis
Servis • Szerviz • Сервисная служба**

Name • Nom • Nome • Naam •
Nazwa • Jméno • Názov • Név •
Denumire • Ísim • Название

Nr. • No. • N° • Номер • Č • Sz

Typ • Type • Tip • Típus • Tipo •
Тип



A  8x	B  4x	C  12x	D  8x	E  8x	F  1x	G  4x	H  8x	I  24x	
J  2x	K  1x	L  1x	M  4x						

1

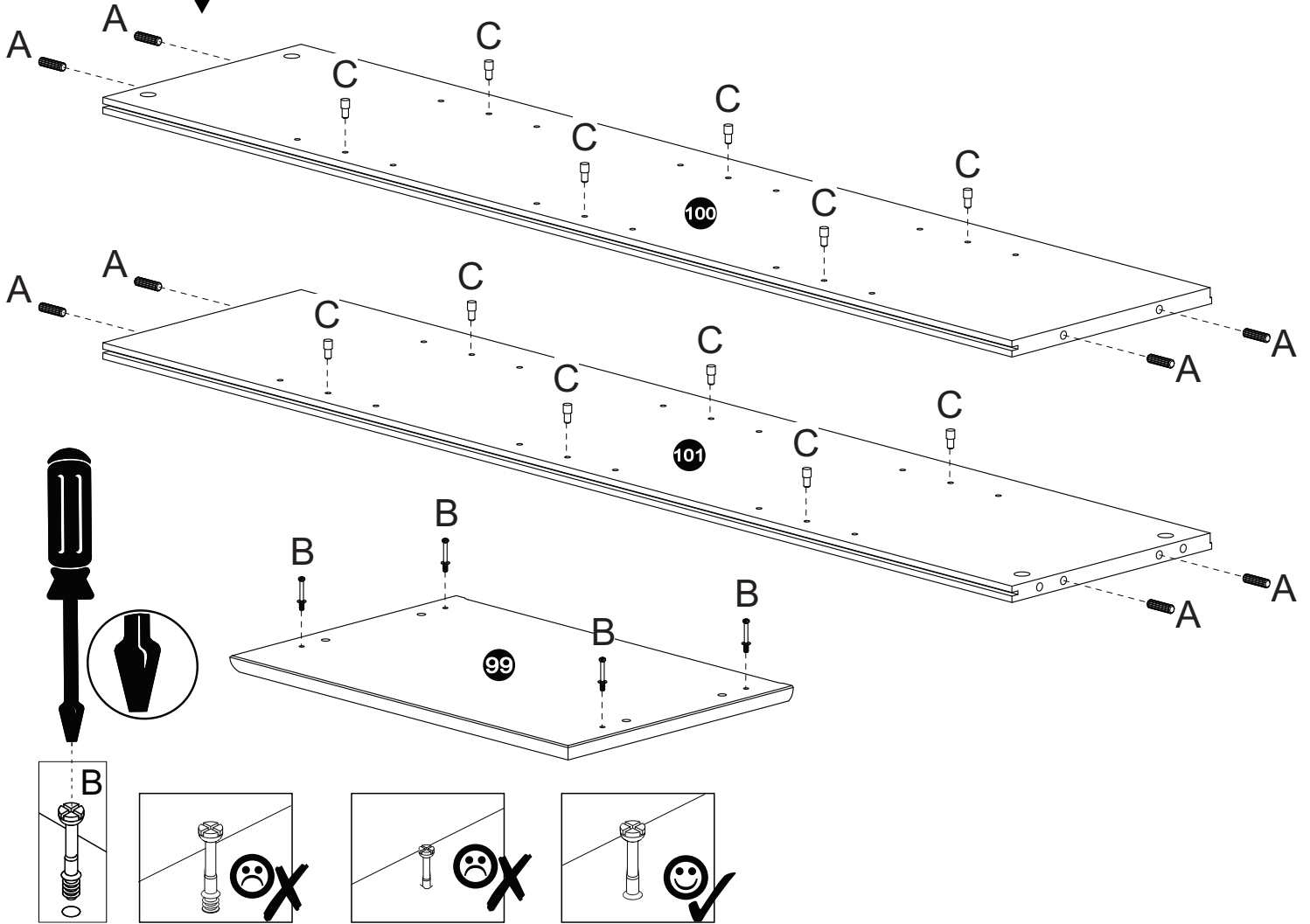
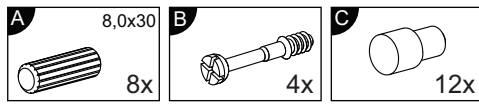

2

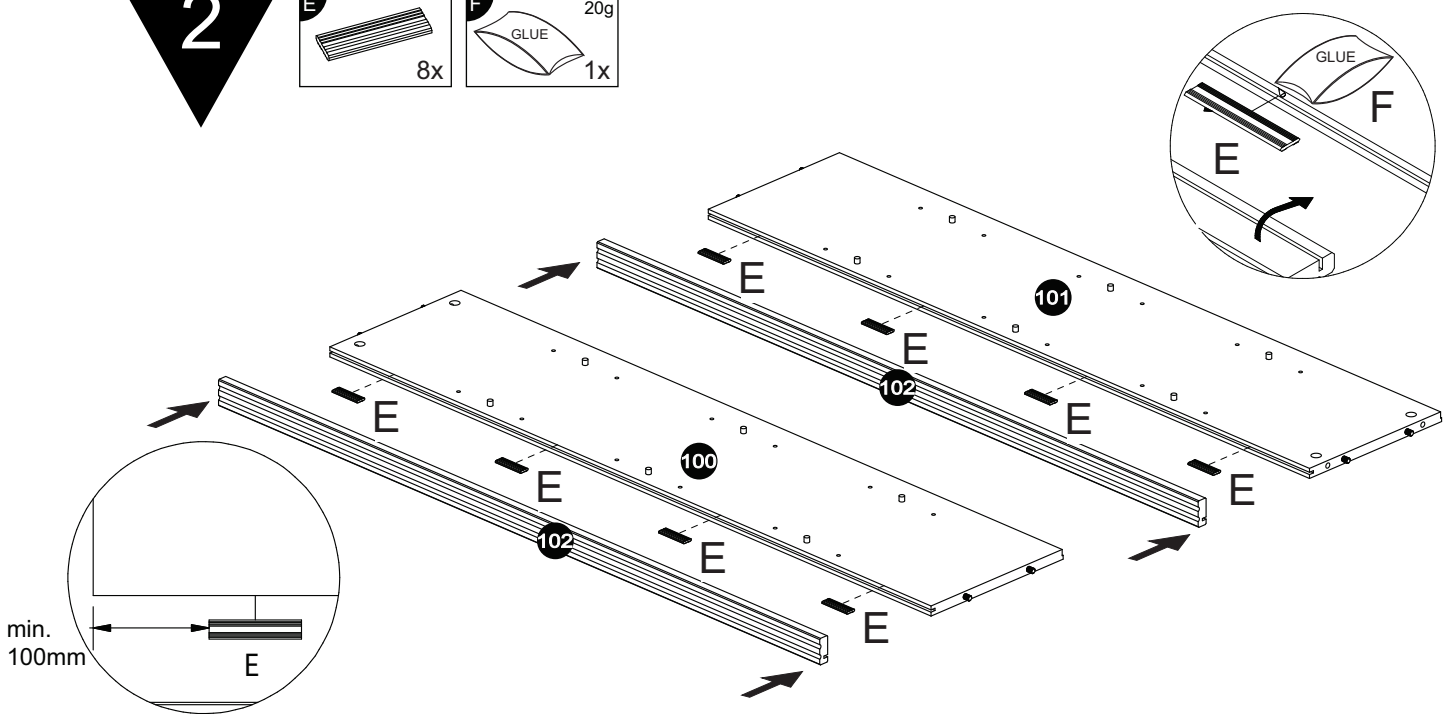
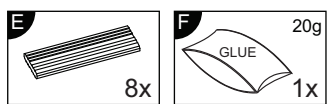

3

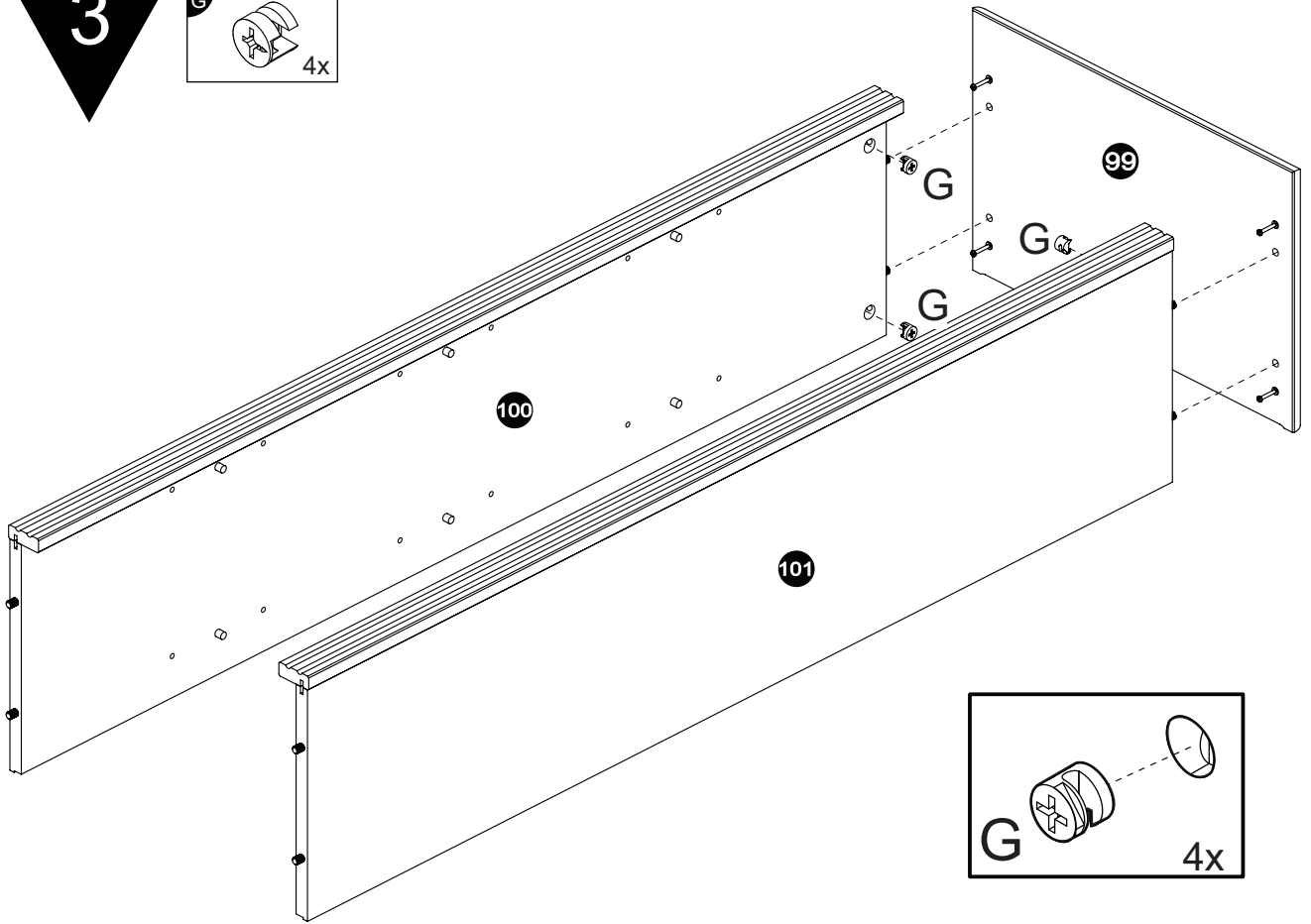
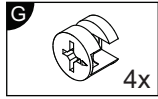

4

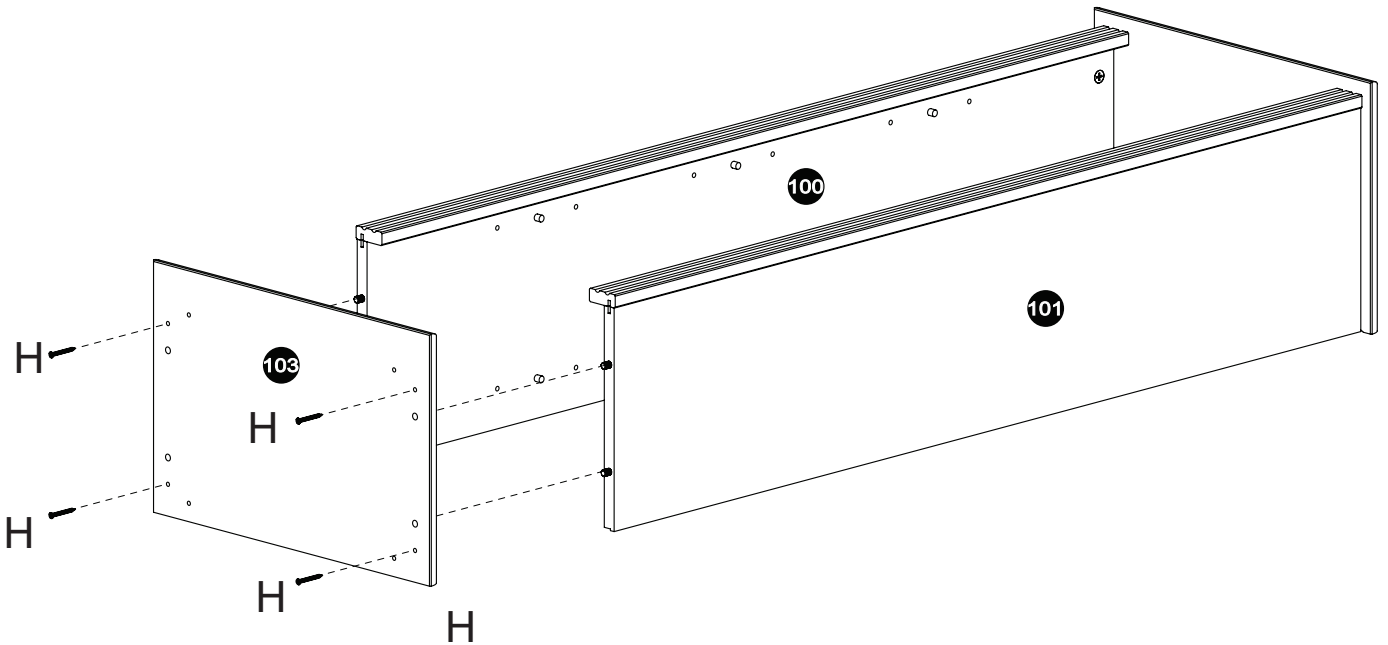
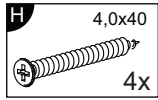

5

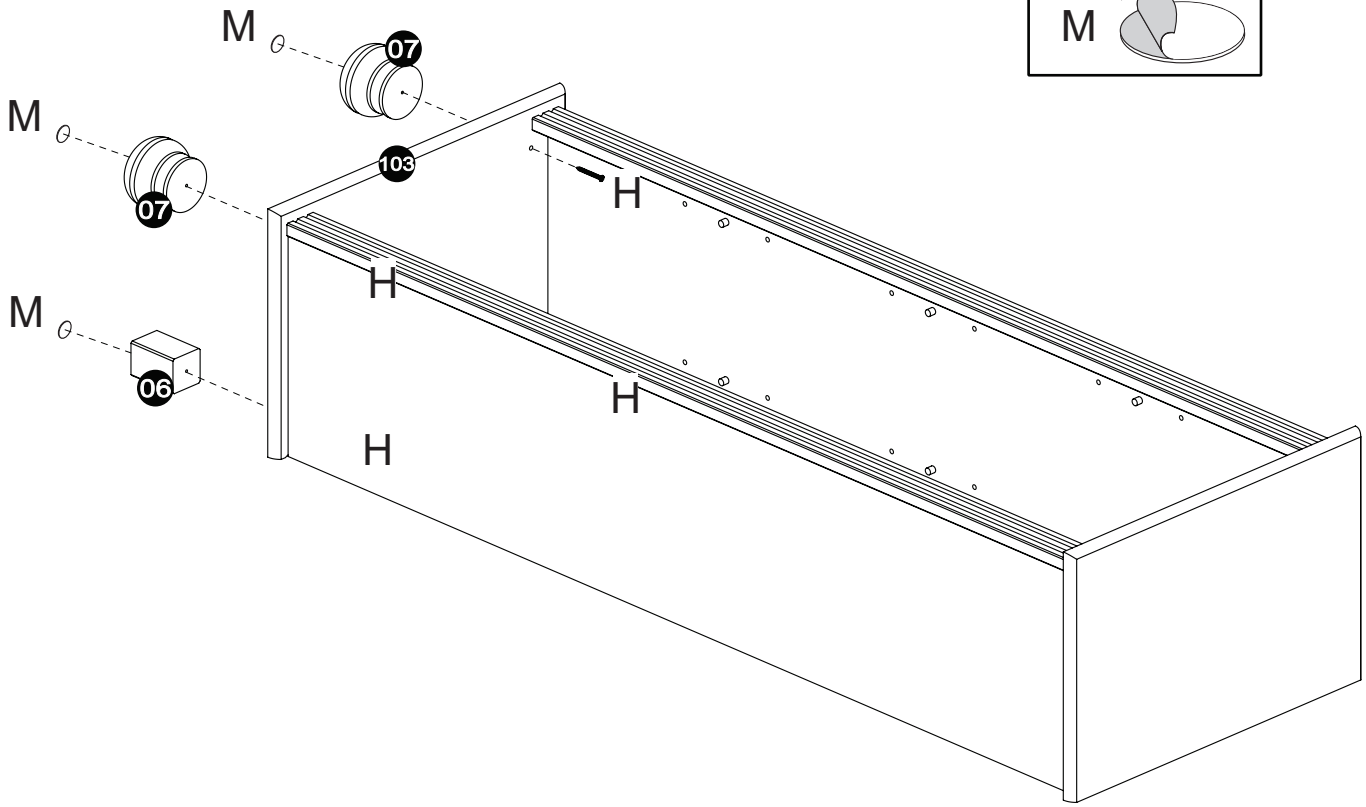
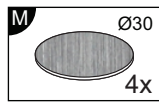
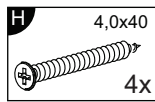

6

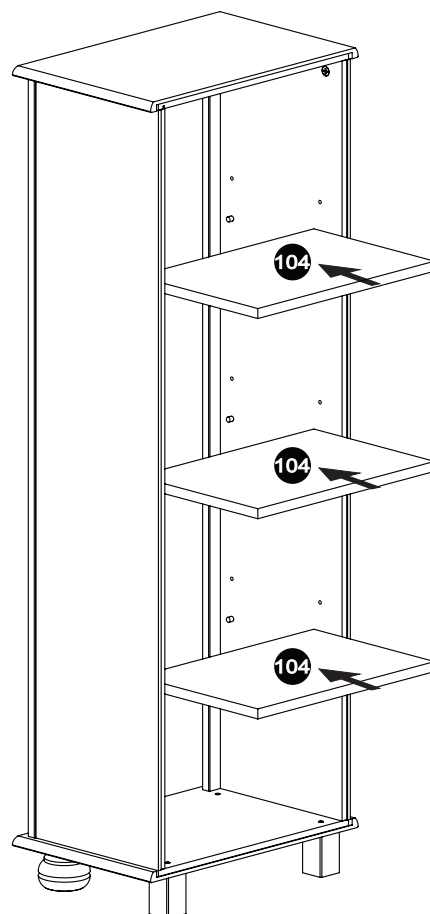

7

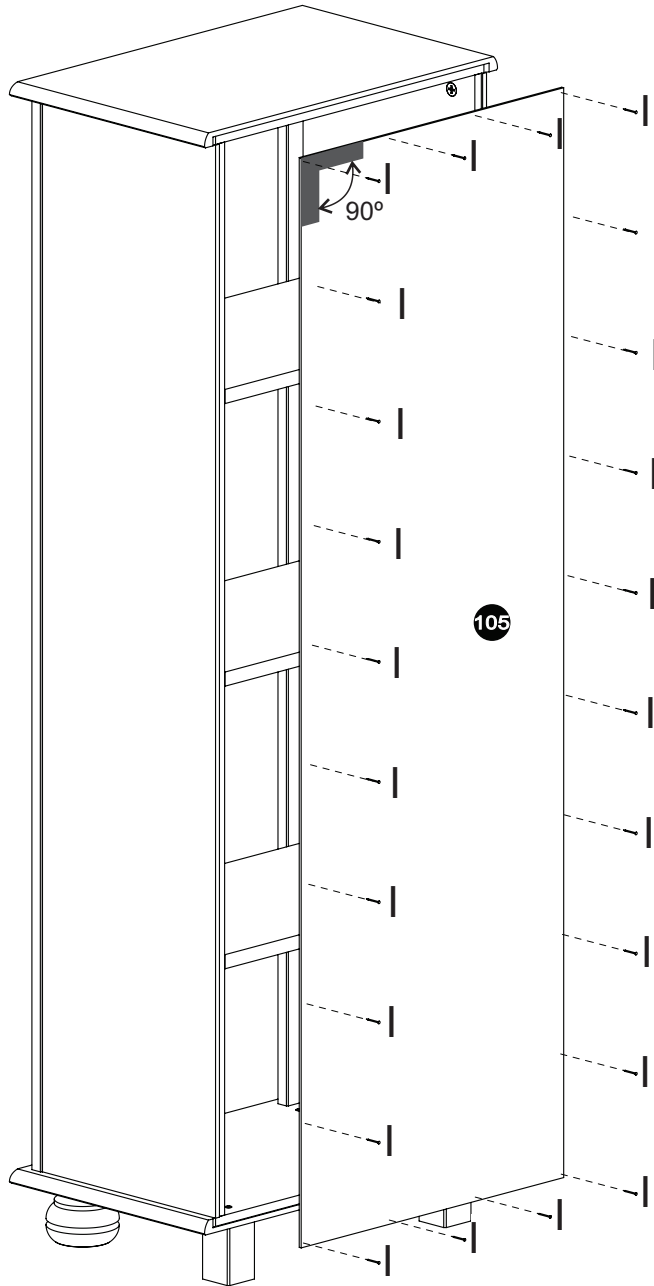
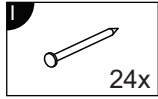

8

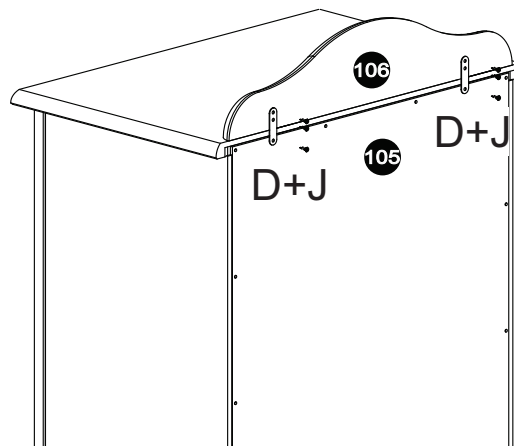
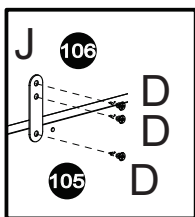
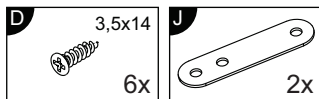

9

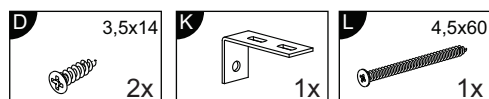

Achtung • Attention • Attenzione Opgelet • Uwaga • Pozor • Figyelem Atenție • Dikkat • Внимание	
(D)	Wandbefestigung dient als Kippschutz – unbedingt anbringen! Bei einigen Wandtypen kann ein Spezialdübel erforderlich sein!
(GB)	The wall fastening serves to prevent tipping – be absolutely sure to mount it! For certain wall types, a special wall plug may be necessary!
(FR)	La fixation murale sert de protection contre le basculement – à installer impérativement ! Pour certains types de murs il faut des chevilles spéciales !
(IT)	Il fissaggio alla parete serve da protezione anti-ribaltamento – attaccarla assolutamente! Per alcune strutture di parete può essere necessario un tassello speciale!
(NL)	Bevestiging aan de muur dient als kantelbescherming – zeker en vast bevestigen! Bij enkele muurtypes is een speciale plug misschien vereist!
(PL)	Mocowanie do ściany jest jednocześnie zabezpieczeniem przed przewróceniem – koniecznie zamontować! Do niektórych rodzajów ścian koniecznie zastosować specjalne kolki mocujące.
(CZ)	Montáž na stěnu slouží jako ochrana proti převrnutí – bezpodmínečně umístěte! U některých typů stěn může být zapotřebí speciální hmoždinka!
(SK)	Upevnenie na stenu slúži ako ochrana proti prevráteniu – bezpodmienečne použite! Pre niektoré druhy stien môže byť potrebná špeciálna hmoždinka!
(HU)	A terméket a falhoz kel rögzíteni, különben az felborulhat! Egyes faltípusoknál speciális tiplit kell használni!
(RO)	Sistemul de fixare la perete servește ca protecție la răsturnare – de montat obligatoriu! Pentru unele tipuri de pereți este posibil să fie necesar un diblu special!
(TR)	Duvardaki sabitleme, devrilmeye karşı bir emniyet tedbiridir ve mutlaka monte edilmelidir! Bazı duvar tiplerinde bunun için özel bir dübel gerekli olabilir!
(RU)	Обязательно установите крепление на стене во избежание опрокидывания! Для некоторых типов стен может потребоваться специальный дюбель!

