

**STEP - 2**

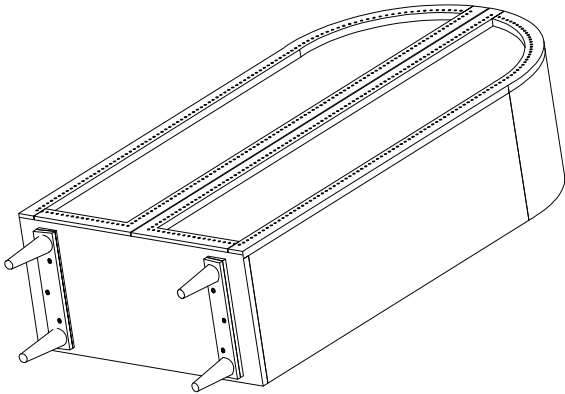

**FINAL PRODUCT**

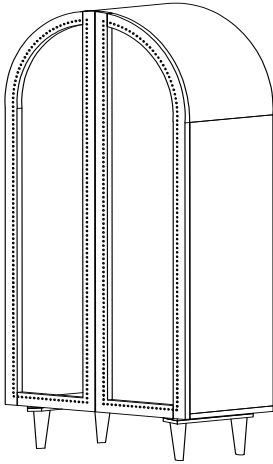

PAGE 4/4

**ASSEMBLY INSTRUCTIONS**

DESCRIPTION:- CALISTO WARDROBE  
Article No. 66955

**0.25 HOURS**

APPROXIMATE ASSEMBLY TIME



2 PERSON ASSEMBLY

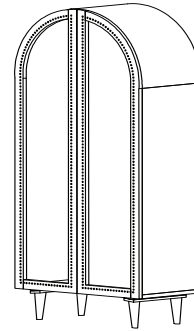

**HARDWARE**

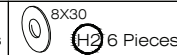
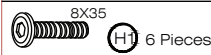

**REQUIRED ASSEMBLY TOOLS**

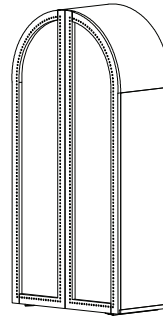

CARCASE :- 1 PIECES

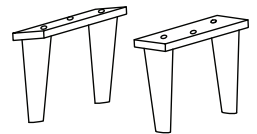

LEGS :- 2 PIECES

PAGE 1/4





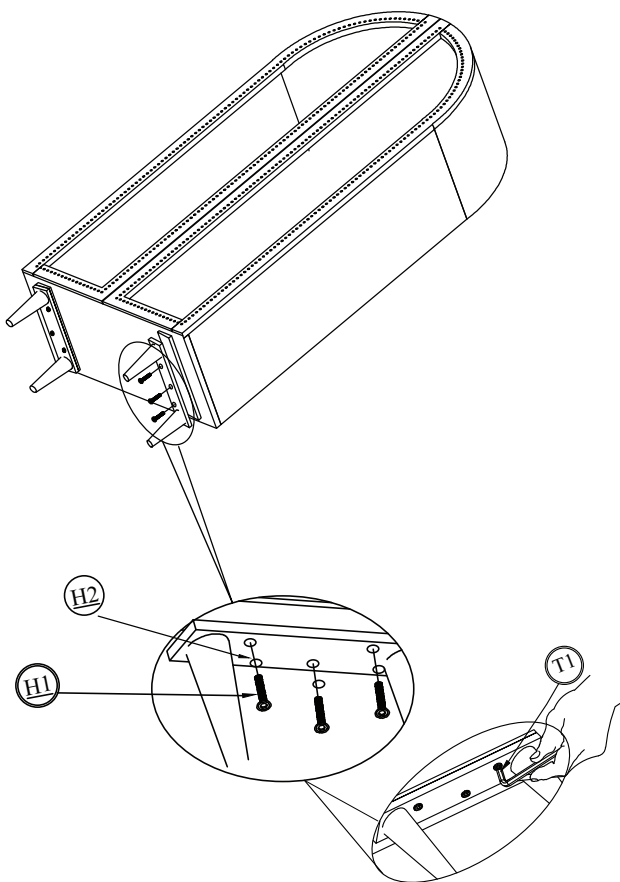











### STEP - 1

NOTE:- Each Leg is numbered.  
Please match according to respective  
markings.



PAGE 2/4

## Care & Maintenance

-    Do not put hot items directly on furniture surface.
-    Do not clean furniture with harsh cleansers or polish.
-    Do not place furniture in direct sunlight.
-    Do not place furniture near heating or cooling vents.
-    Do not write on furniture without a padded barrier to protect the surface.
-    Do not place furniture outside. For indoor use only.
-    Dust and pick-up spills using a clean, non-colored, lint-free cloth.
-    Stains may be removed with mild soap solution and damp cloth.

PAGE 3/4

# ! Achtung Sicherheitshinweis / Attention Safety Note !

## Anleitung für Kippsicherung

1. Mit den kurzen Schrauben eine Halterung je rechts und links z.B. auf der obersten Platte (Abb. 1) des Möbelstücks, bzw. immer an der Rückwand (siehe Abb.2) anbringen.
2. Das Möbelstück so ausrichten, dass die Position der Wandhalterungen bestimmt und markiert werden kann. Das Möbelstück für die Montage zur Seite schieben.
3. Das Möbelstück wie gewünscht ausrichten und die Halterungen vorsichtig festziehen. Bei Trockenmauern bitte Dübel verwenden.

Abb. 1

(ggf. Wanddübel verwenden)



Abb. 2

(ggf. Wanddübel verwenden)



2

Halterungen  
/Brackets



2

Dübel  
/Dry wall anchors

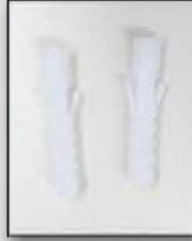

2

lange Schrauben  
/long screws



2

kurze Schrauben  
/small screws



## Anti tip kit instructions

1. Using short screws, attach one of the brackets on each end of the furniture's back, on the top surface for example, or inside (see second picture / Abb.2)
2. Move furniture into its final position to measure and mark locations of the bracket. Move the furniture out of the way for assembly.
3. Move the furniture into final position and tighten screws carefully. Please use dowels for dry walls.