

# Bergen

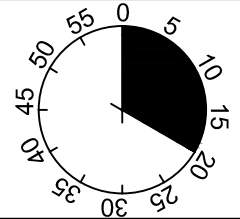
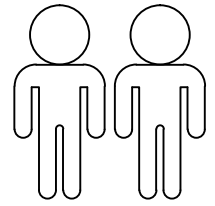
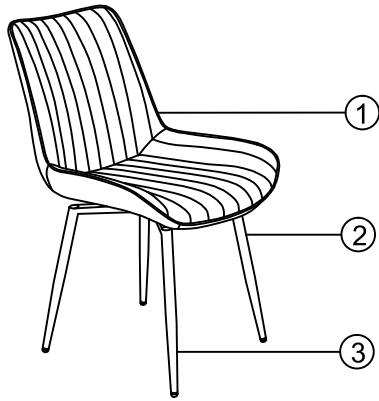

1

2

3

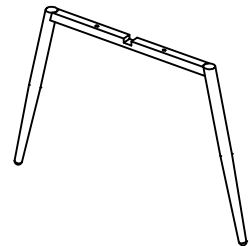
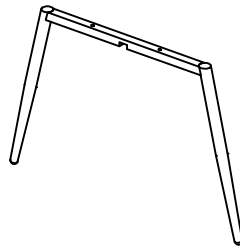
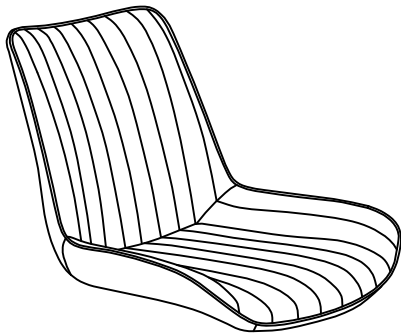

4

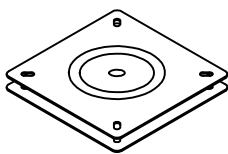

DT 266 N 160x160mm

1	1 x
2	1 x
3	1 x
4	1 x

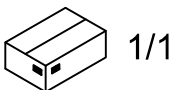



<b>A</b>	M6X13	<b>B</b>	M6x16	<b>C</b>	M6x25	<b>D</b>	Ø18xØ6x1.5	<b>E</b>	Ø18xØ8x10	<b>F</b>	5MM
4x		6x		2x		8x		2x		1x	
<b>G</b>	T3.0x85x85										
1x											

I.

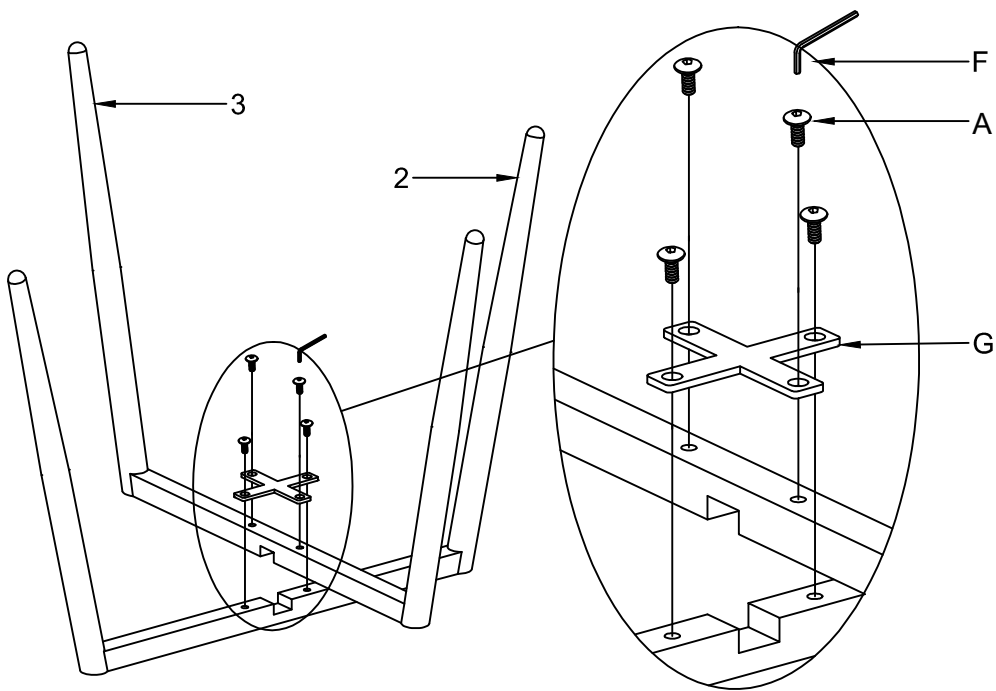

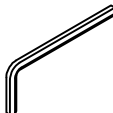
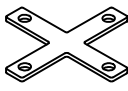

1

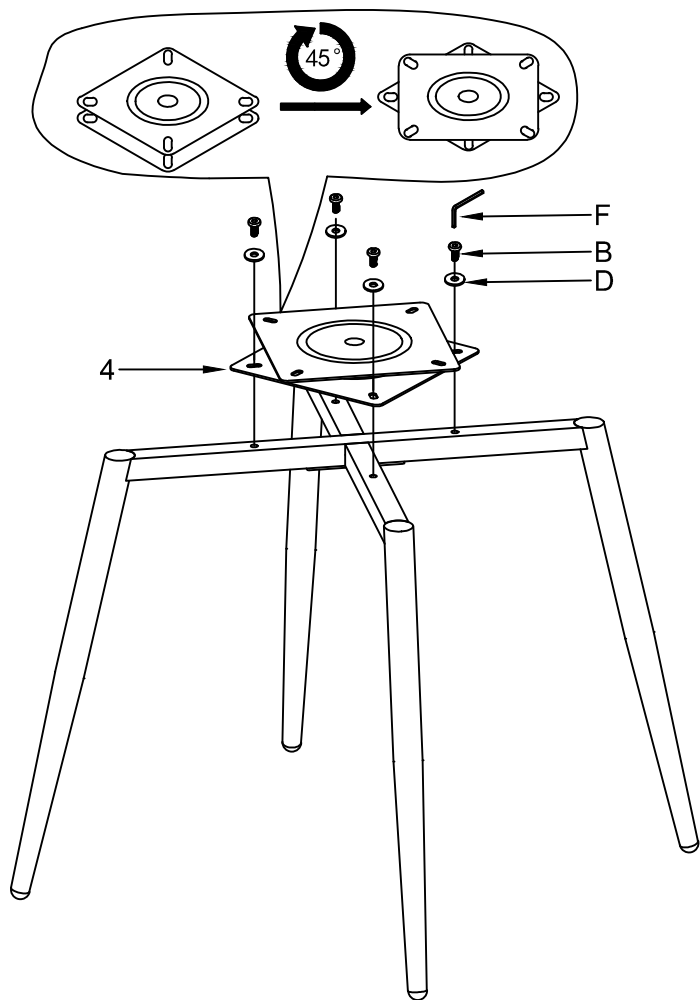

A	M6x13		4x
F	5MM		1x
G	T3.0x85x85		1x
			

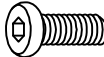
2

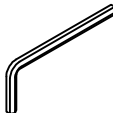



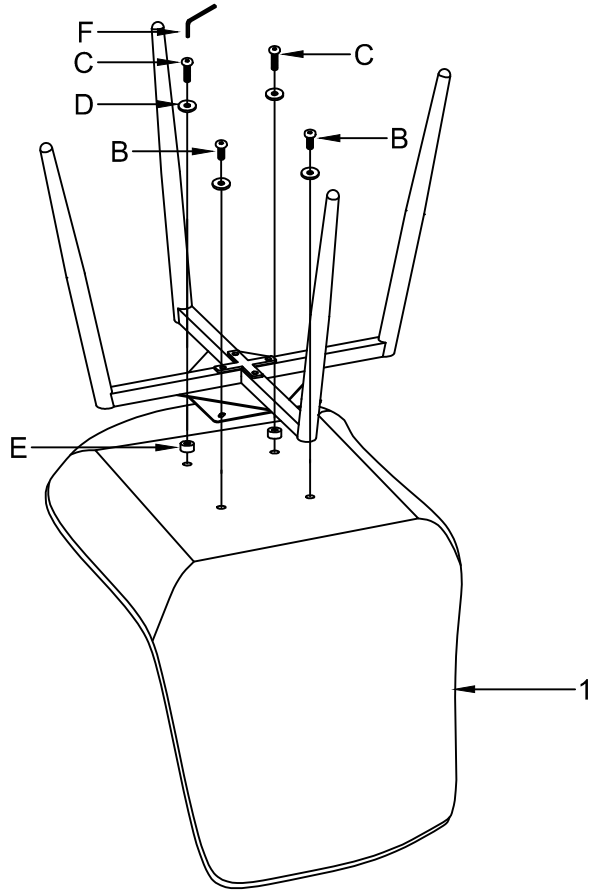

B	M6x16		4x
D	Ø18xØ6x1.5		4x
F	5MM		1x
			

II.

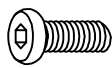
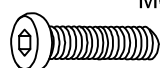

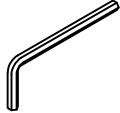
3



B	M6X16		2x
C	M6X25		2x
D	Ø18xØ6x1.5		4x
E	Ø18xØ8x10		2x
F	5MM		1x
			

4

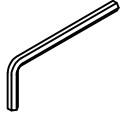

F	5MM		1x
			

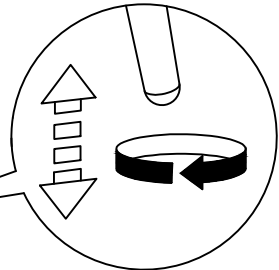

**LE TRI  
+ FACILE**



**BAC  
DE  
TRI**

Séparez les éléments avant de trier