

ARNGAST
3100-8300
8100-3300
2018-11/1

D MONTAGEANLEITUNG
BEDIENUNGSANLEITUNG

NL HANDLEIDING VOOR DE MONTAGE
GEBRUIKSAANWIJZING

TR MONTAJ TALIMATI
KULLANIM KLAVUZU

RO INSTRUCȚIUNI DE INSTALARE
INSTRUCȚIUNI DE UTILIZARE

FR NOTICE DE MONTAGE
MANUEL INSTRUCTIONS

HU KÖZGYŰLÉS UTASÍTÁSOK
KEZELÉSI UTASÍTÁS

SI NAVODILA ZA MONTAŽO
NAVODILA ZA UPORABO

ES INSTRUCCIONES DE MONTAJE
MANUAL DEL USUARIO

GB ASSEMBLY INSTRUCTIONS
INSTRUCTION MANUAL

PL INSTRUKCJA MONTAŻU
INSTRUKCJA OBSŁUGI

RU ИНСТРУКЦИЯ ПО МОНТАЖУ
ИНСТРУКЦИЯ ПО ЭКСПЛУАТАЦИИ

IT ISTRUZIONI DI MONTAGGIO
MANUALE DI ISTRUZIONI

SK MONTÁŽNY NÁVOD
NÁVOD NA POUŽITIE

CZ MONTÁŽNÍ NÁVOD
NÁVOD K POUŽITÍ

PT INSTRUÇÕES DE MONTAGEM
MANUAL DO USUÁRIO

HR UPUTE ZA MONTAŽU
UPUTE ZA UPOTREBU

Name · Naam · Nazwa · İsim · Название · Nume · Nome · Názov · Názov ·
 Název · Neve

ARNGAST

Typ · Type · Tip · Тип · Tipo · Típus

3100-8300; 8100+0089

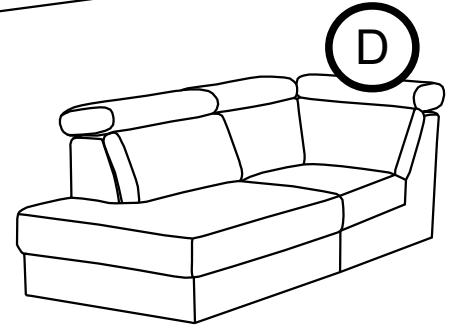
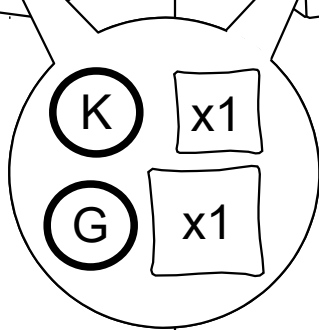
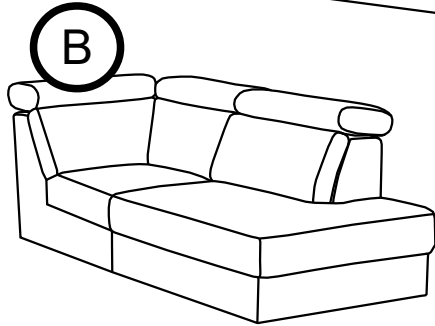
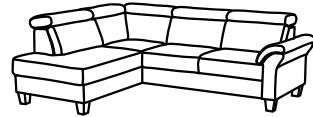
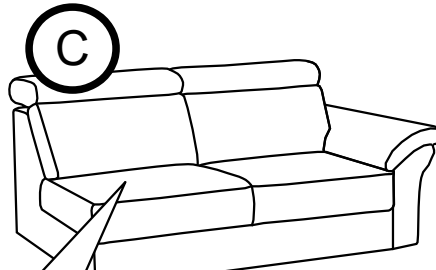
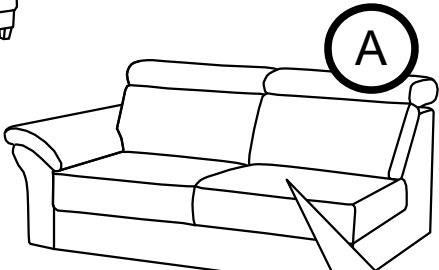
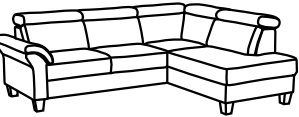
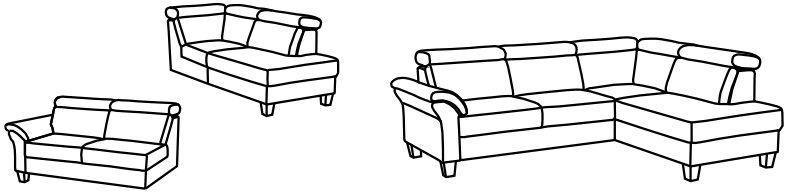
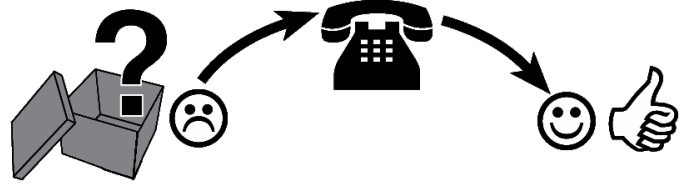
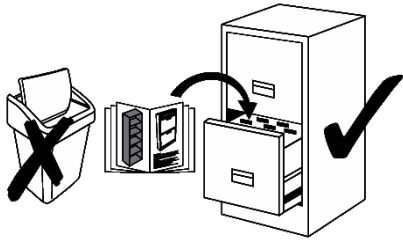

v1

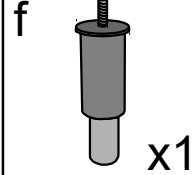
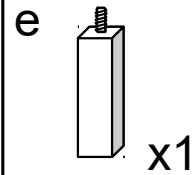
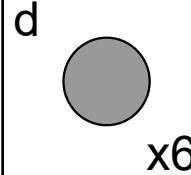
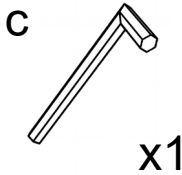
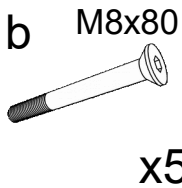
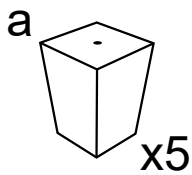
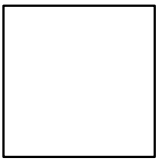

v2

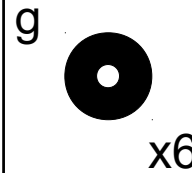
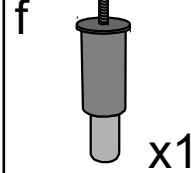
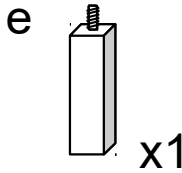
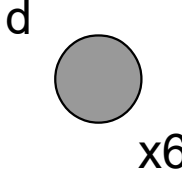
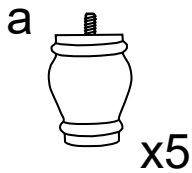
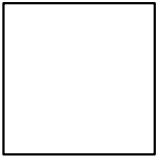

v3

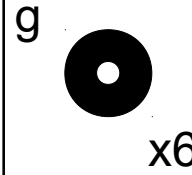
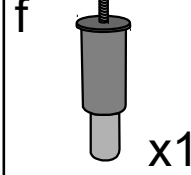
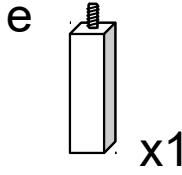
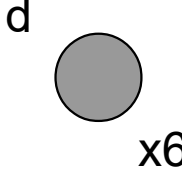
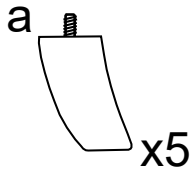
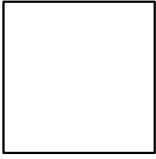

v4

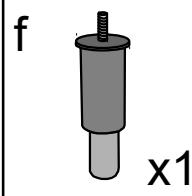
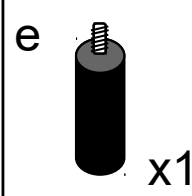
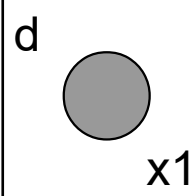
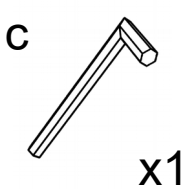
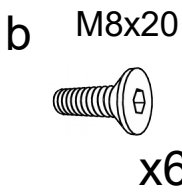
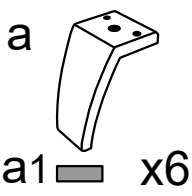
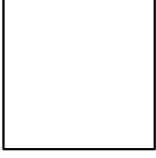

v1

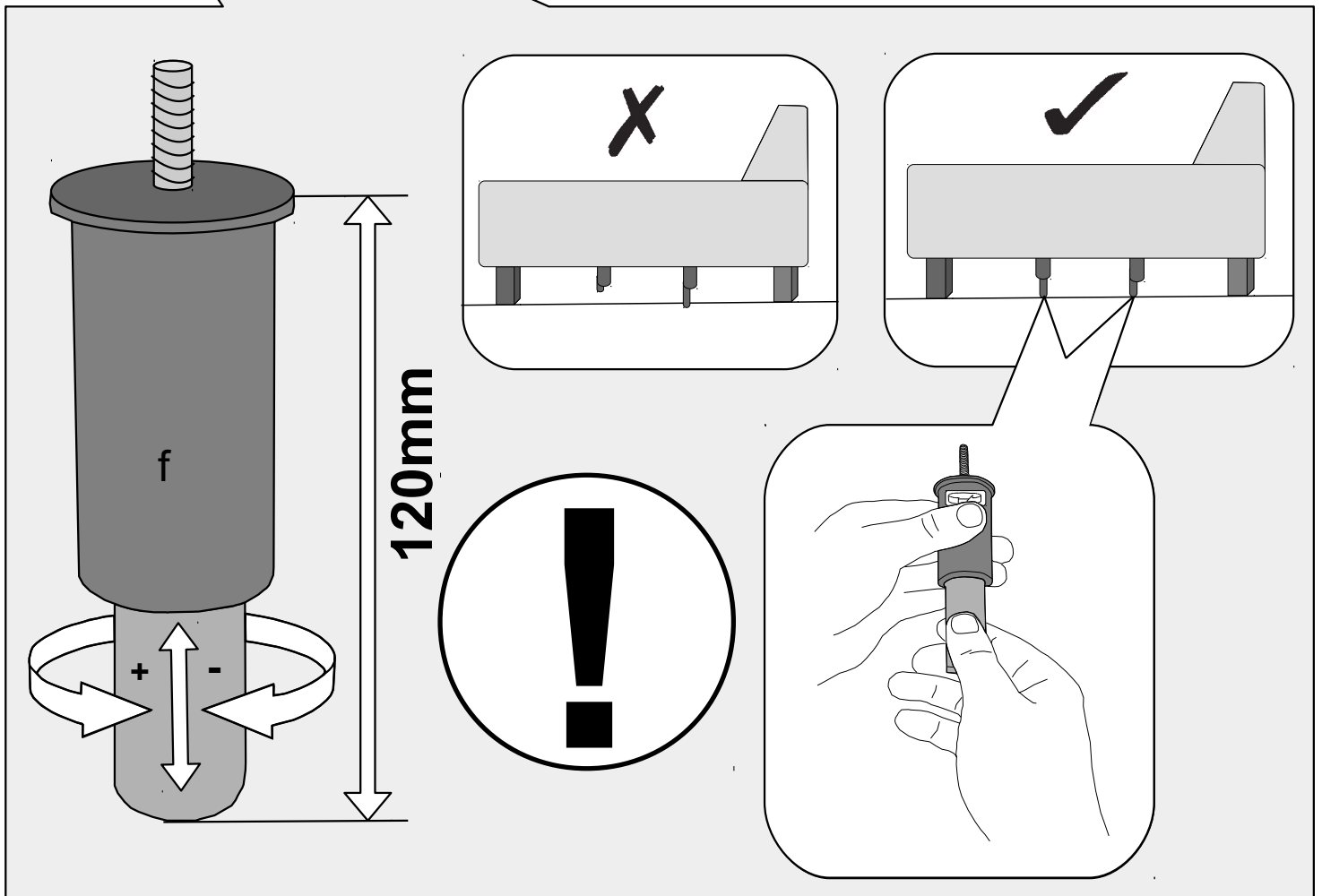
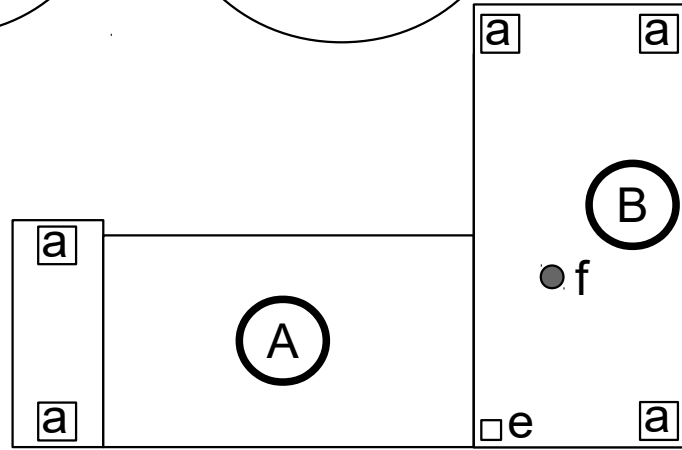
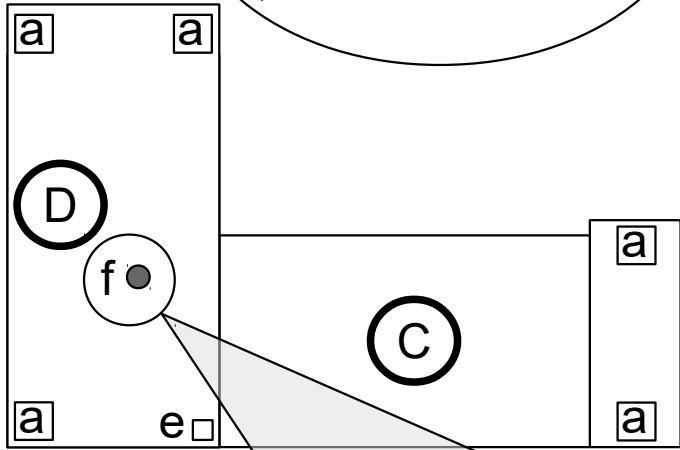
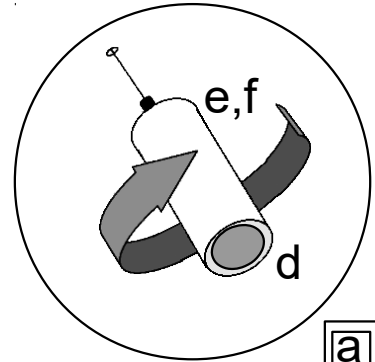
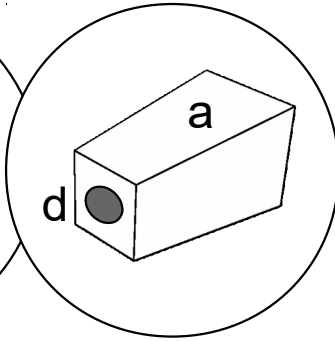
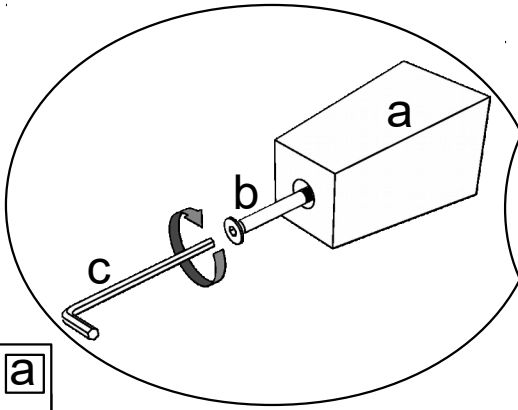
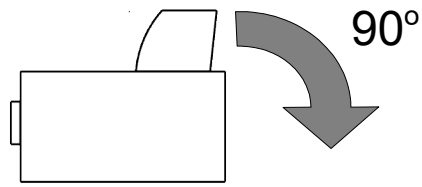

v2 v3

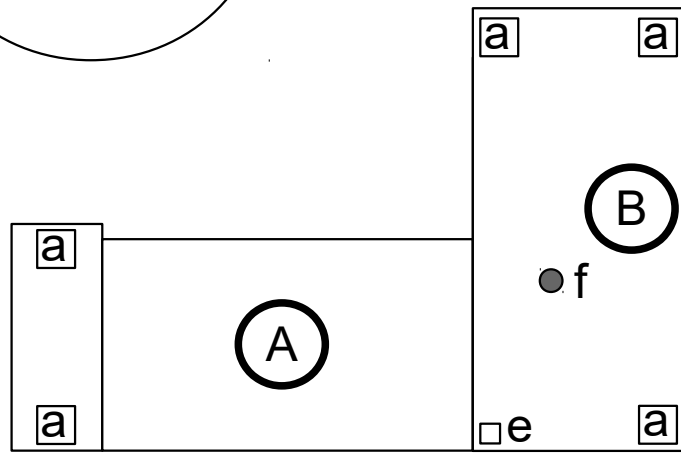
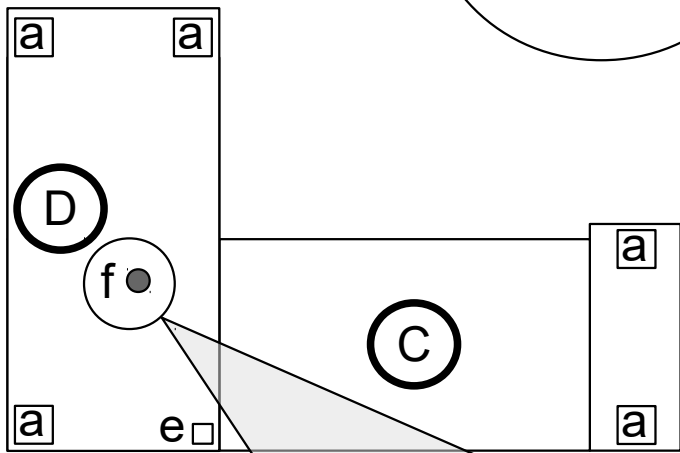
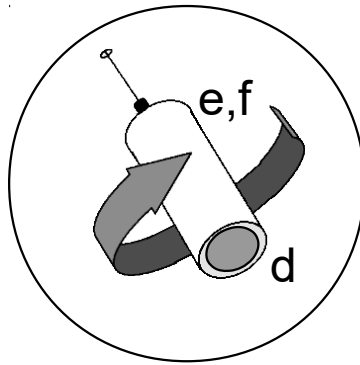
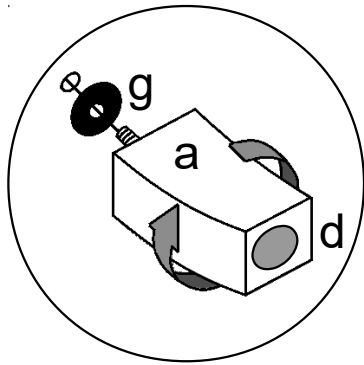
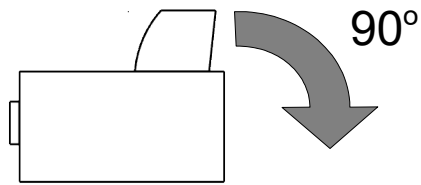

120mm

f

X

✓

!

v4

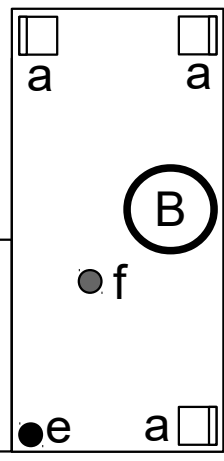
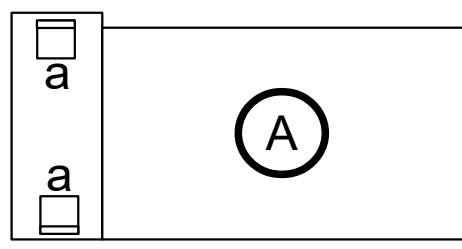
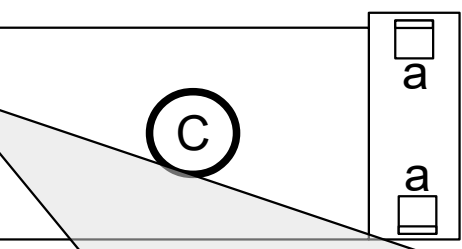
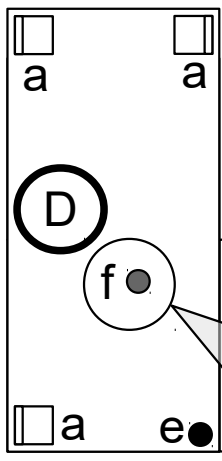
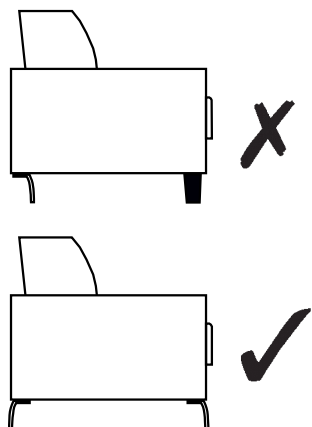
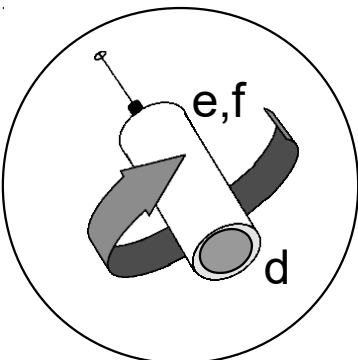
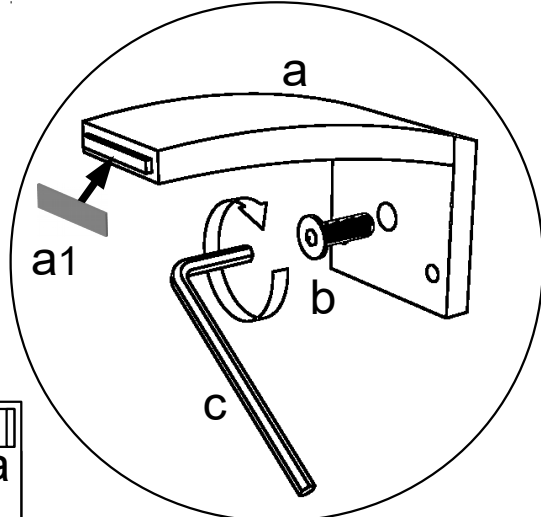
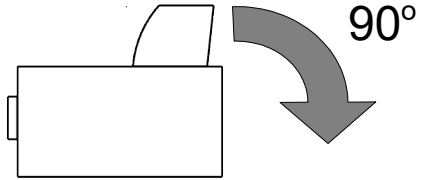

120mm

f

+

-

X

✓

!

Diagram illustrating the assembly of a cylindrical component (labeled 'f') with a height of 120mm. The component has a threaded top section. The diagram shows two incorrect ways to adjust the component (marked with 'X') and one correct way (marked with a checkmark). A large exclamation mark (!) indicates a warning. A hand is shown adjusting the component, with a '+' sign indicating upward adjustment and a '-' sign indicating downward adjustment. The diagram also shows a hand holding a small component, likely a screw or pin, used for adjustment.

