

Hardtop-Pavillon LGFP8157

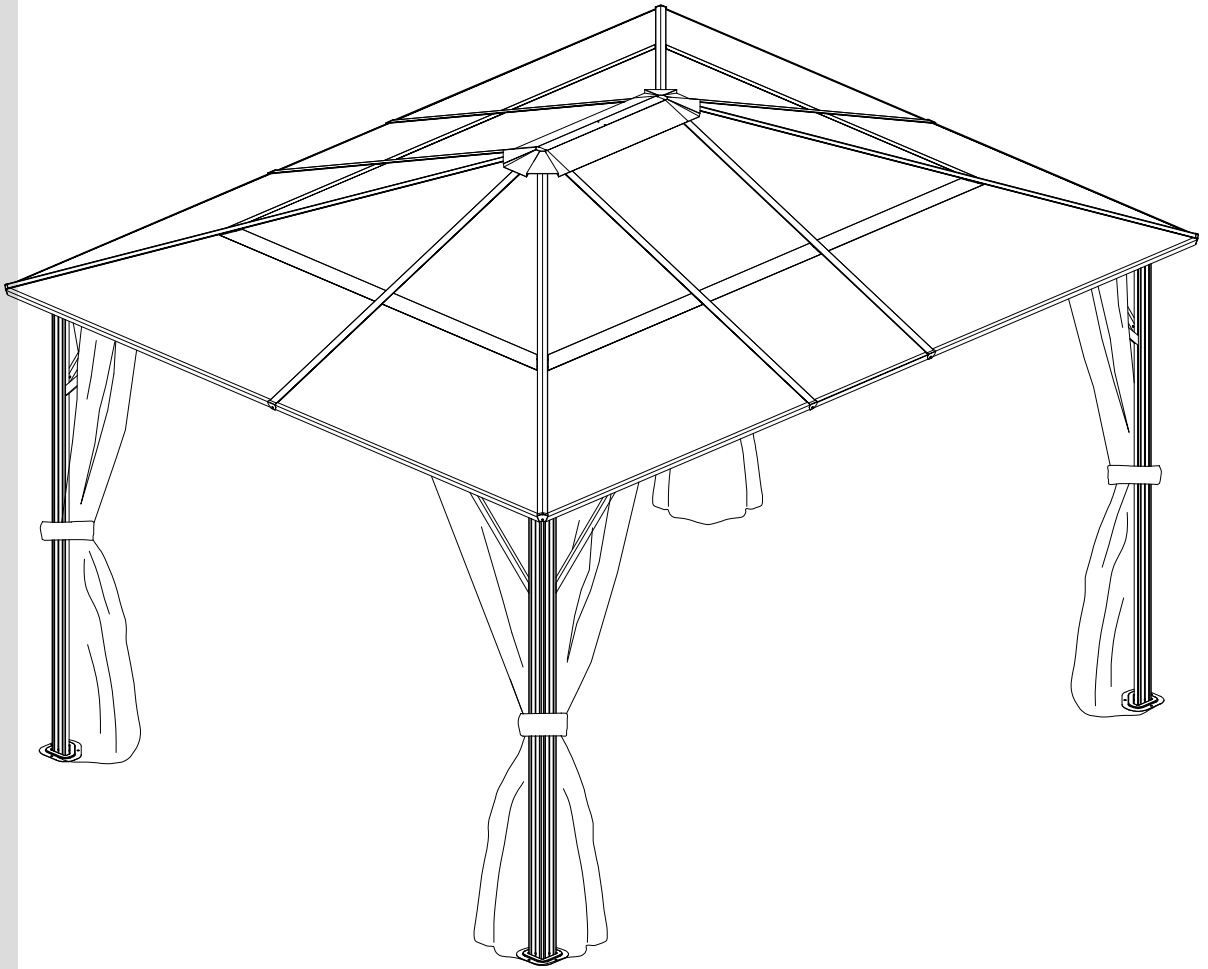

D Montageanleitung

IT Istruzioni di montaggio

NL Handleiding voor de montage

GB Assembly instructions

F Notice de montage

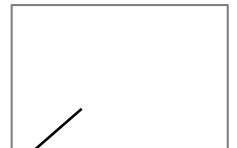

D

WICHTIG, FÜR SPÄTERE BEZUGNAHME DIESES DOKUMENT AUFBEWAHREN! SORGFÄLTIG LESEN!

Bestimmungsgemäßer Gebrauch

- Dieser Artikel ist nur als Sonnenschutz oder leichter Schutz vor einem kurzen Regenschauer z.B. bei Festlichkeiten und nicht als Langzeitschutz geeignet.
- Zum Schutz vor Regen oder Schnee ist er nicht gedacht.
- Dieser Artikel ist nur zum Einsatz im privaten Bereich bestimmt und nicht für den gewerblichen Gebrauch geeignet.



Sicherheitshinweise

- Erstickungs- / Verletzungsgefahr! Lassen Sie Kinder nicht mit der Verpackung spielen. Sie könnten an der Folie ersticken oder sich an der Umverpackung verletzen.
- Einige Teile können scharfkantig sein, achten Sie während der Montage hierauf und ziehen sie sich gegebenenfalls Handschuhe an.
- Verschrauben Sie alle Verbindungen zuerst nur leicht. Ziehen Sie die Schrauben erst fest, nachdem alle Schrauben angebracht sind.
- Bezug vom Pavillon bei aufkommendem Wind oder Gewitter rasch abnehmen, da er eine große Windangriffsfläche bietet. Der Pavillon könnte sonst von einer Böe erfasst und umgeworfen werden. Dabei kann er Verletzungen oder Schäden verursachen oder selbst beschädigt werden.
- Bei anhaltendem Niederschlag darauf achten, dass sich keine Wasserlachen auf dem Dach bilden, eventuell die Dachplane vom Gestell entfernen, da sonst Einsturzgefahr besteht.
- Durch Befestigung mit Abspannleinen und Zeltnägeln und durch Verschrauben der Standfüße mit dem Untergrund (Schrauben und Dübel) können Sie dem Pavillon zusätzliche Standfestigkeit geben.
- Pavillon nicht unbeaufsichtigt stehen lassen.
- Der Pavillon ist kein Kinderspielzeug. Er könnte Kinder beim Umfallen verletzen. Kinder sollten beaufsichtigt werden, wenn sie sich im oder in der Nähe des Pavillons aufhalten.
- An den Querstreben des Pavillons nichts aufhängen oder gar Klimmzüge daran machen. Nichts an den Pavillon anlehnen.
- Der Pavillon kann Ihre Haut vor direkter UV-Strahlung, aber nicht vor reflektierenden UV-Strahlen schützen. Deshalb zusätzlich kosmetische Sonnenschutzmittel verwenden



Brandgefahr!

- Niemals offenes Feuer in der Nähe oder unterhalb des Pavillons entfachen (z.B. brennende Kerzen oder Gartenfackeln, Grills). Der Pavillon könnte Feuer fangen oder durch Funkenflug beschädigt werden. Halten Sie den Pavillon von starken Hitzequellen wie Terrassenheizstrahler, Grill etc. fern.

Pflege und Lagerung

- Der Bezug besitzt eine Fleckenschutz-Imprägnierung. Zum Reinigen verwenden Sie am besten eine weiche Bürste und ein wenig Seifenlauge.
- Bei stärkerer Verschmutzung können Sie den Bezug abnehmen und bei 30° von Hand säubern. Der Bezug ist nicht für Maschinenwäsche, Chemisches Reinigen, Bleichen und Bügeln geeignet.
- Alle tragenden Teile wie Gestänge, Schrauben etc. regelmäßig überprüfen.
- Mindestens 1x im Jahr alle Metallteile auf Rost überprüfen und falls erforderlich behandeln.
- Lagern Sie Gestänge und Bezug im trockenen Zustand über Winter in einem trockenen, gut durchlüfteten Raum.

Von der Gewährleistung ausgeschlossen sind:

- Schäden durch nicht-bestimmungsgemäßen Gebrauch (z.B. gewerbliche Nutzung)
- Normaler Verschleiß und Farbveränderungen der Textilbespannung
- Lackschäden, die auf normale Abnutzung zurückzuführen sind
- Schäden durch nicht-bestimmungsgemäßen Gebrauch (z.B. gewerbliche Nutzung)
- Schäden durch Wind, Umfallen des Zelts, starkes Ziehen an dem Gestell.
- Schäden durch nicht-bestimmungsgemäßen Gebrauch (z.B. gewerbliche Nutzung)
- Schäden durch Wind, Umfallen des Zelts, starkes Ziehen an dem Gestell.

IMPORTANTE, CONSERVARE LE PRESENTI ISTRUZIONI PER OGNI ULTERIORE CONSULTAZIONE! LEGGERE CON ATTENZIONE!

Uso conforme alla destinazione

- Il presente articolo serve soltanto a riparare dai raggi del sole o da brevi acquazzoni ad es. nel corso di festeggiamenti, e non è indicato ai fini di una protezione prolungata. Non è pensato per proteggere da pioggia o neve.
- Il presente articolo è destinato soltanto all'impiego nell'ambito domestico e non è indicato all'uso in ambito professionale.



Norme di sicurezza

- Pericolo di soffocamento/di lesioni! Non permettere ai bambini di giocare con l'imballaggio. Correrebbero il rischio di soffocamento a causa delle pellicola, o di lesioni a causa dell'imballaggio esterno.
- Alcune parti possono presentare spigoli vivi, si raccomanda pertanto di prestarvi attenzione nel montaggio, eventualmente indossare per cautela guanti di protezione.
- Avvitare tutti i raccordi dapprima leggermente. Stringere solo dopo che saranno applicate tutte le viti.
- Togliere immediatamente la capote del gazebo quando si alza il vento o minaccia un temporale, perché la sua ampia superficie sarebbe irrimediabilmente esposta alle sferzate del vento. Il gazebo potrebbe essere investito e travolto da una folata, provocando lesioni o danni, o anche rovinandosi.
- In caso di rovesci persistenti, assicurarsi che sul tetto non si formino pozze d'acqua, meglio ancora se si rimuove il telone dalla base, altrimenti sussiste il pericolo di crollo.
- Fissando con tiranti e chiodi da tenda e avvitando i piedini al suolo (viti e tasselli) è possibile conferire al gazebo un'ulteriore stabilità.
- Non lasciare incustodito il gazebo.
- Il gazebo non è un giocattolo. Ribaltandosi potrebbe causare lesioni ai bambini. Si raccomanda di vigilare i bambini quando si trovano nel gazebo o nelle sue vicinanze.
- Non appendere alcun oggetto alle stecche del gazebo e non usarle per fare acrobazie. Non appoggiare nessun oggetto al gazebo.
- Il gazebo protegge la pelle dai raggi diretti UV, ma non dai raggi UV riflessi. Applicare pertanto sulla pelle un prodotto con schermo solare.



Pericolo d'incendio!

- Non accendere mai fiamme libere nelle vicinanze o sotto il gazebo (ad es. candele o fiaccole da giardino, barbecue). Il gazebo potrebbe prendere fuoco o subire danni per via delle scintille svolazzanti. Tenere lontano il gazebo da forti fonti di calore, quali radiatori da terrazza, grill e simili.

Stoccaggio – Manutenzione

- La capote è dotata d'impregnazione antimacchia. Per pulire il tessuto usare preferibilmente una spazzola morbida e un po' d'acqua saponata. Se lo sporco è più ostinato, potete togliere la capote e lavarla a mano a 30 °C. La capote non è idonea al lavaggio in lavatrice, al lavaggio a secco, al candeggio e alla stiratura.
- Revisionare periodicamente tutte le parti portanti quali il telaio, le viti e simili.
- Controllare almeno una volta l'anno se le parti di metallo sono arrugginite, e se necessario trattare i punti colpiti.
- D'inverno riporre il telaio e la capote asciutti in un ambiente asciutto e ben aerato.

Sono esclusi dalla garanzia:

- normale usura e scolorimento del telo
- deterioramenti della vernice imputabili al normale consumo
- danni causati dall'uso non conforme alla destinazione (ad es. utilizzo in ambito professionale)
- danni causati dal vento, dal ribaltamento del telo, da sforzi orizzontali del telaio

**BELANGRIJK, BEWAAR DIT DOCUMENT ALS REFERENTIE IN DE TOEKOMST!
ZORGVULDIG LEZEN!****Reglementair gebruik**

- Dit artikel is alleen geschikt als bescherming tegen de zon of als lichte bescherming tegen een korte regenbui bijv. bij feestelijkheden en niet als bescherming voor een lange tijd. Voor de bescherming tegen regen of sneeuw is het niet bedoeld.
- Dit artikel is alleen bestemd voor het privégebruik en niet voor commerciële doeleinden.

**Veiligheidsinstructies**

- Verstikkings-/verwondingsgevaar! Laat kinderen niet met de verpakking spelen. Ze kunnen stikken in de folie of zich bezeren aan de verpakking.
- Enkele stukken kunnen scherpe randen vertonen, let er bij de montage op en trek eventueel handschoenen aan.
- Schroef alle verbindingen eerst slechts lichtjes vast. Draai de schroeven pas vast, nadat alle schroeven zijn aangebracht.
- Overtrek van het paviljoen snel verwijderen bij een opkomende wind of een onweer, omdat het een groot opperlak betreft dat gevoelig is voor de wind. Het paviljoen kan anders door een windstoot worden gegrepen en omvergeworpen. Daarbij kan het verwondingen of schade veroorzaken of zelf worden beschadigd.
- Bij aanhoudende neerslag moet u ervoor zorgen dat er geen waterplassen worden gevormd op het dak, verwijder eventueel het dakzeil van het frame omdat er anders een risico is op instorten.
- Door bevestiging met spanriemen en tentnagels en door het vastschroeven van de poten met de ondergrond (schroeven en pluggen) kunt u het paviljoen extra standvastigheid geven.
- Laat het paviljoen niet onbewaakt staan.
- Het paviljoen is geen speelgoed voor kinderen. Het kan kinderen verwonden als het omvalt. Kinderen moeten onder toezicht staan als ze in of in de buurt van het paviljoen verblijven.
- Hang niets aan de dwarsbalken van het paviljoen op of trek u er ook niet aan op. Niets tegen het paviljoen laten rusten.
- Het paviljoen kan uw huid beschermen tegen directe UV-stralen, maar niet tegen reflecterende UV-stralen. Gebruik daarom extra cosmetische zonnebeschermingsmiddelen.

**Brandgevaar!**

- Maak nooit een open vuur aan in de buurt of onder het paviljoen (bijv. brandende kaarsen of tuinfakkels, barbecues). Het paviljoen kan vuur vatten of door rondvliegende vonken worden beschadigd. Houd het paviljoen weg van sterke hittebronnen zoals terraswarmtestralers, de barbecue enz.

Onderhoud + opslag

- De overtrek beschikt over een beschermende impregnering tegen vlekken. Voor de reiniging gebruikt u het best een zachte borstel en een sopje. Bij sterke bevuilding kunt de overtrek verwijderen en manueel schoonmaken op 30 °C. De overtrek is niet geschikt voor de machinewas, chemische reiniging, het bleken en strijken.
- Controleer regelmatig alle dragende onderdelen zoals stangen, schroeven enz.
- Kijk minstens 1 x per jaar alle metalen stukken na en behandel ze indien nodig.
- Berg stangen en overtrek tijdens de winter in een droge toestand weg op een droge, goed verluchte plaats.

De garantie dekt geen:

- Normale slijtage en kleurveranderingen van de textieloverspanning
- Lakschade die te wijten is aan algemene slijtage
- Schade door niet reglementair gebruik (bijv. industrieel gebruik)
- Schade door wind, het omvallen van de tent, het stevige trekken aan het frame

IMPORTANT, HOLD ON TO THIS DOCUMENT FOR LATER REFERENCE! READ CAREFULLY!**Proper use**

- This item is suitable only for use as a sun shade or for protection from a light rain shower (e. g. at a party) and is not suitable as a more long-term shelter. It is not intended to protect from rain or snow.
- This item is intended for domestic use only and is not suitable for commercial use.

**Safety notes**

- Risk of suffocation/injury! Do not allow children to play with the packaging. They could suffocate in the packaging film or injure themselves on the outer packaging.
- Some parts may have sharp corners. Keep this in mind when assembling the table and, if necessary, wear protective gloves.
- Start by screw tightening all connections only somewhat. Only tighten the screws completely once all screws are in place.
- Take down the gazebo cover quickly in case of approaching wind or storm as the large surface area will catch the wind easily. The gazebo could otherwise be caught by a gust of wind and be blown over. This could cause injury or damage or could damage the gazebo itself.
- In the case of prolonged rain, ensure that water does not build up on the roof of the gazebo. If necessary, remove the roof covering from the frame to avoid the danger of the gazebo collapsing.
- The gazebo can be made more secure by using guy lines and tent pegs and by screwing the feet into the base (screws and plugs).
- Do not leave the gazebo unattended.
- This gazebo is not a toy. Children could injure themselves if it tumbles down. Children should be supervised when inside or near the gazebo.
- Do not hang anything on the gazebo's poles and absolutely do not use them to do chin-ups. Do not lean anything against the gazebo.
- The gazebo can protect your skin from direct UV rays but not from reflected UV rays. Therefore use additional sun protection.

**Fire hazard!**

- Never light an open fire near or inside the gazebo (e. g. lighted candles or garden torches, barbecues). The gazebo could catch fire or be damaged by flying embers. Keep the gazebo away from intensive heat sources such as patio heaters, barbecues etc.

Care and storage

- The cover has a stain-resistant treatment. To clean, it is best to use a soft brush and a small amount of a soapy solution. In case of heavy soiling you can remove the cover and hand wash at 30 °C. The cover is not suitable for machine washing, dry cleaning, bleaching or ironing.
- Regularly check all structural parts such as poles, screws etc.
- Check all metal parts at least once a year for corrosion and if necessary, treat them.
- Once dry, store the poles and cover in a dry, well-ventilated place over the winter.

The following are not covered by the warranty:

- Normal wear and tear, changes to the colour of the textile upholstery
- Damage to the finish attributed to normal wear and tear
- Damage due to improper use (e. g. commercial use)
- Damage due to wind, collapse of the tent, pulling on the frame intensely.

**IMPORTANT, CONSERVER CE DOCUMENT POUR VOUS Y RÉFÉRER
ULTÉRIEUREMENT ! LE LIRE ATTENTIVEMENT !****Utilisation conforme aux prescriptions**

- Cet article convient uniquement comme protection solaire ou comme protection légère contre une petite pluie de courte durée, p. ex. pour des fêtes mais n'est pas une protection permanente. Il ne convient pas à une protection contre la pluie ou la neige.
- Cet article est uniquement destiné à un usage privé et ne convient pas à un usage commercial.

**Consignes de sécurité**

- Risque d'asphyxie/de blessure! Ne laissez pas les enfants jouer avec l'emballage. Ils pourraient s'asphyxier avec le film ou se blesser avec les emballages de l'emballage.
- Certaines pièces peuvent être coupantes, pendant le montage, faites attention et passez éventuellement des gants.
- Vissez d'abord légèrement toutes les liaisons. Serrez les vis seulement après les avoir toutes mises en place.
- Retirer la toile du pavillon si du vent ou de l'orage s'annonce car elle offre une surface de prise au vent. Sinon le pavillon pourrait être emporté par une bourrasque et être renversé. Ceci pourrait causer des dégâts et des blessures ou ceci pourrait aussi endommager le pavillon.
- En cas de précipitations durables, veillez à qu'il ne se forme aucune poche d'eau sur le toit, enlever éventuellement la toile du toit sinon il y a un risque d'effondrement.
- En fixant des cordes de haubanage ou en vissant les pieds dans le sol (vis et chevilles), vous donnez une stabilité supplémentaire au pavillon.
- Ne pas laisser le pavillon sans surveillance.
- Le pavillon n'est pas un jouet. En cas de chute, les enfants pourraient se blesser. Surveiller les enfants lorsqu'ils se trouvent dans ou à proximité du pavillon.
- Ne rien pendre ni ne faire aucun exercice de gymnastique sur les barres transversales du pavillon. Ne rien appuyer contre le pavillon.
- Le pavillon peut protéger votre peau contre les rayons UV directs, mais par contre les rayons UV réfléchissants. Pour cette raison, utiliser en plus un produit de protection solaire.

**Risque d'incendie !**

- Ne jamais allumer un feu à proximité ou sous le pavillon (p. ex. des bougies ou des torches de jardin, des barbecues). Le pavillon pourrait s'enflammer ou être endommagé par des étincelles. Éloignez le pavillon de puissantes sources de chaleur comme des radiateurs de terrasse, des barbecues etc.

Entretien + Stockage

- La toile possède une imprégnation pour la protéger contre les taches. Pour le nettoyage, utilisez de préférence une brosse douce et un peu de savon. En cas de saleté importante, vous pouvez retirer la toile et la laver à la main à 30 °C. La toile ne peut pas être lavée en machine, ni donnée chez le teinturier, elle ne doit être ni blanchie ni repassée.
- Vérifier régulièrement toutes les parties portantes comme les barres, les vis etc.
- Au moins 1 fois par an, vérifiez si toutes les pièces métalliques n'ont pas de rouille, si nécessaire, les traiter.
- Stockez les barres et la toile à sec pendant l'hiver dans un local sec et bien ventilé.

Exclusion de la garantie :

- Usure normale et décolorations de la toile
- Dommages sur la peinture dus à une usure normale
- Dommages dus à une utilisation non conforme aux prescriptions (p. ex. utilisation commerciale)
- Dommages par le vent, la chute de la toile, une forte traction sur les barres

Service • Servizio

Name • Nome • Nom • Naam	LGFP8157	
Nr. • No. • n°		
Typ • Type • Tipo	3x3,65m	

- D** Produktberatung: 01806/ 63 06 30 Festnetz 20 Cent/Anruf, Mobilfunk max. 60 Cent/Anruf
Quelle D Fachberatung: 01806/111 100 Festnetz 20 Cent/Anruf, Mobilfunk max. 60 Cent/Anruf
- NL** call center telefoonnummer 0900-1901 15 ct/min
- A** Universal: 0043/662/4485 59 Fachberatung Heimwerken (zum Festnetztarif – je nach Betreiber)
Otto: 0043/316/606 159 Beratung Heimwerken (zum Festnetztarif – je nach Betreiber)
Quelle: 0043/662/9005 59 Fachberatung Heimwerken (zum Festnetztarif – je nach Betreiber)
- CH** Bei Problemen oder Fragen wenden Sie sich bitte an unsere Servicehotline!
Quelle CH: 0848 85 85 00 Ackermann CH: 0848 85 85 11, Jelmoli Technik: 0848 858 530
- F** Si vous avez des problèmes ou des questions, contactez notre service en ligne!
Quelle CH: 0848 85 85 01 Ackermann CH: 0848 85 85 21, Jelmoli Technik: 0848 858 530
- I** Se ha problemi o domande si rivolge al nostro servizio di assistenza!
Quelle CH: 0848 85 85 02 Ackermann CH: 0848 85 85 31, Jelmoli Technik: 0848 858 530

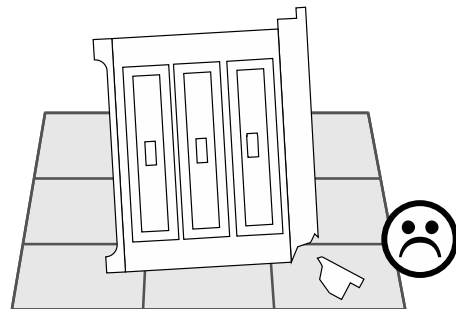
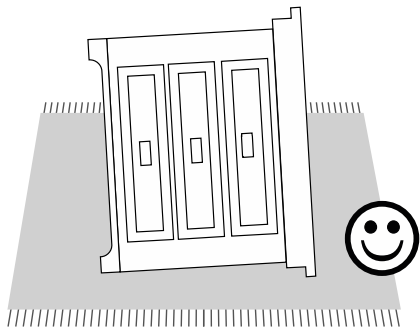

Imported by AproductZ GmbH,
Werner-Otto-Str.1-7, D-22179 Hamburg, Germany

Assembly Instructions

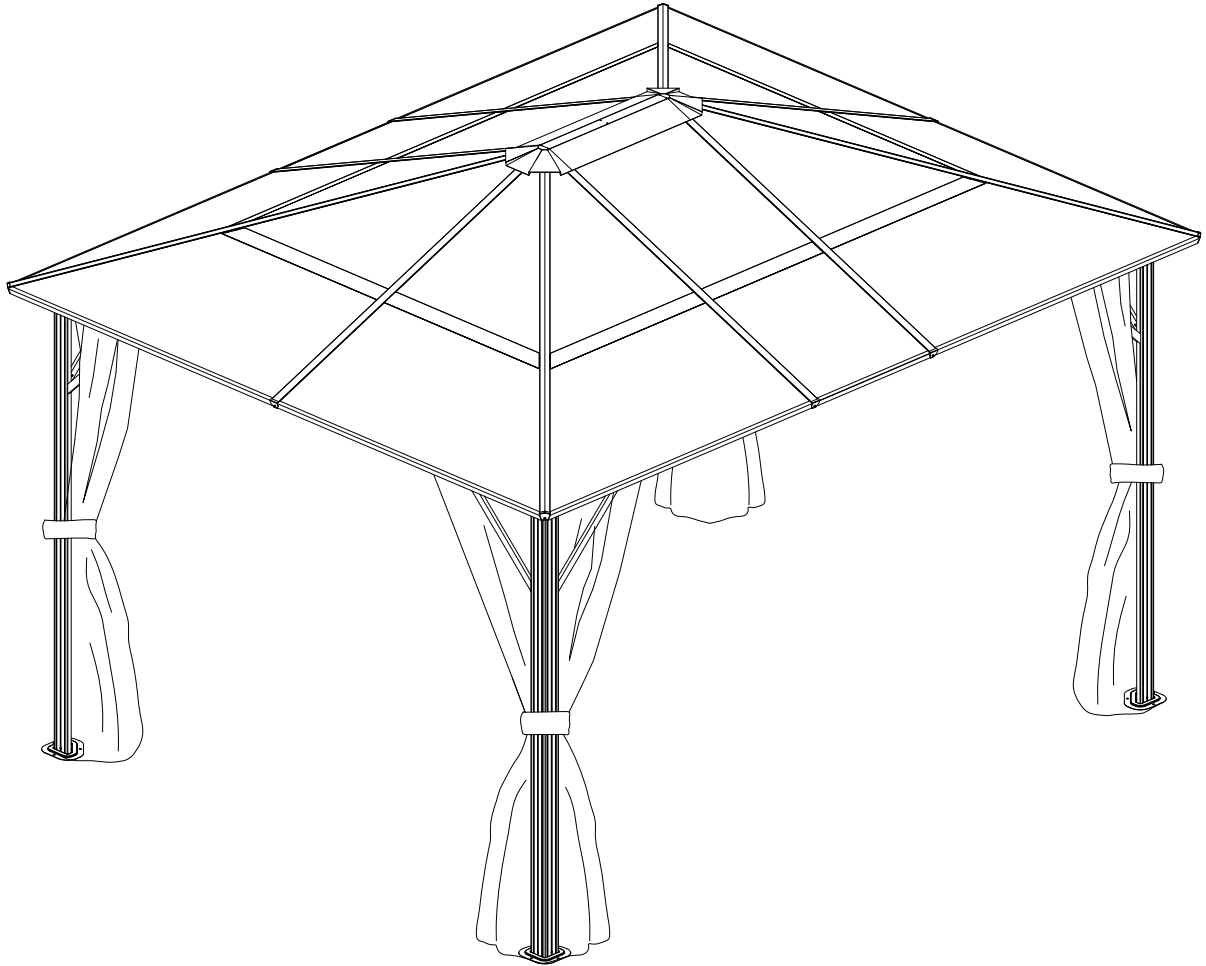

Part list

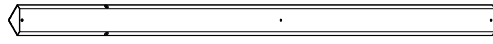

A 4x

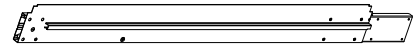

C 2x

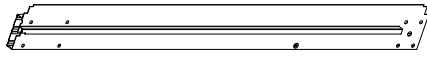

C1 2x

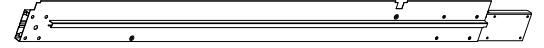

C2 2x

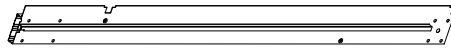

C3 2x

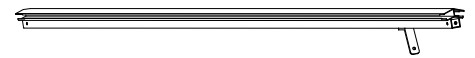

D 4x



D1 6x

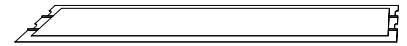

E 4x

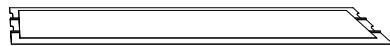

E1 4x

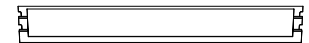

E2 2x



F 4x



F1 4x

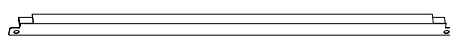

F2 2x

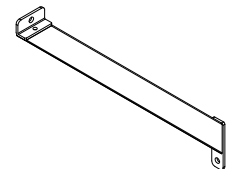

G 4x

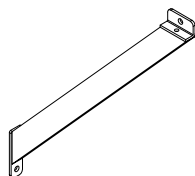

G1 4x

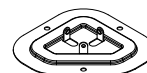











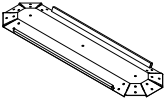
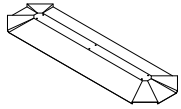

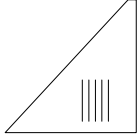
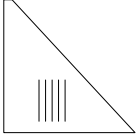

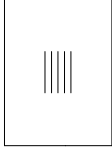
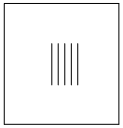
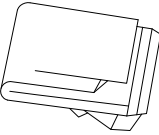
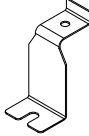
B 4x



H 52x

Part list

 J 4x	 K 4x	 L 1x	 L1 1x
 M 6x	 M1 4x	 N 4x	 N1 4x
 P 4x	 P1 4x	 Q 2x	 Q1 2x
 R 4x	 S 4x	 T 1x S4	 U 8x
 M5x10 1 16x	 ST4.2x12 2 24x	 M6x16 3 32x	 M6x12 4 72x
 M6x20 5 3x			

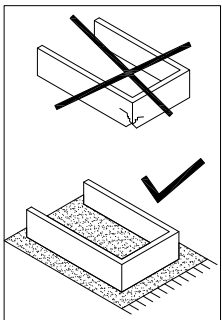

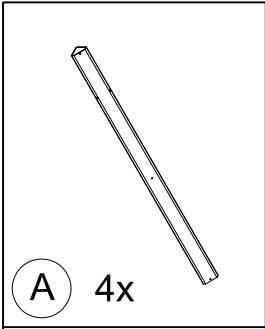

A 4x

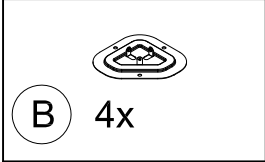

B 4x

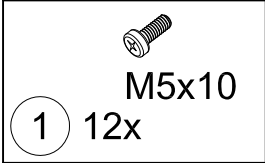

M5x10
1 12x

<1>

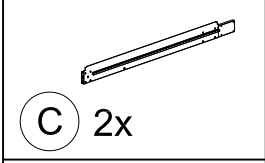
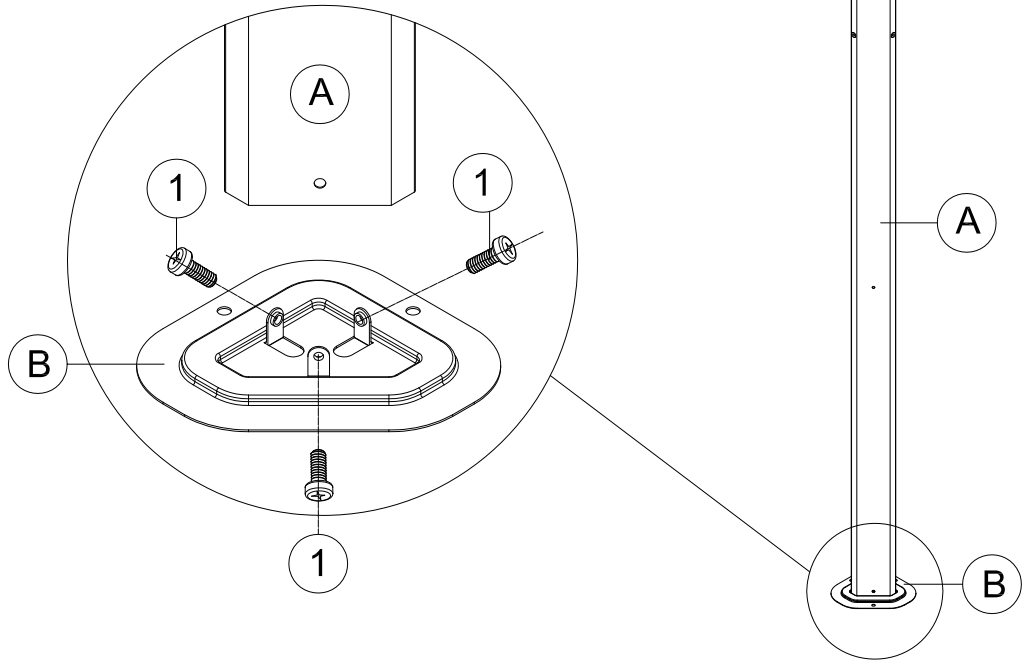

C 2x

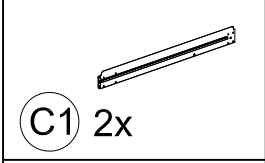

C1 2x

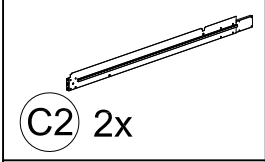

C2 2x

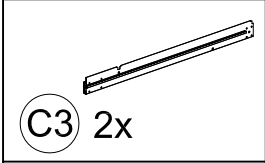

C3 2x

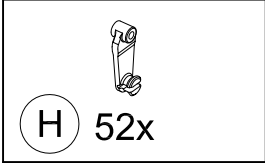

H 52x

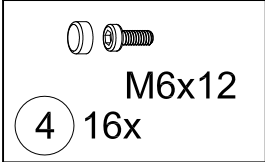

M6x12
4 16x

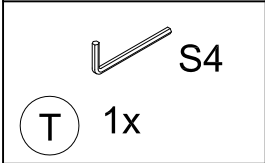

S4
T 1x



4

<2>

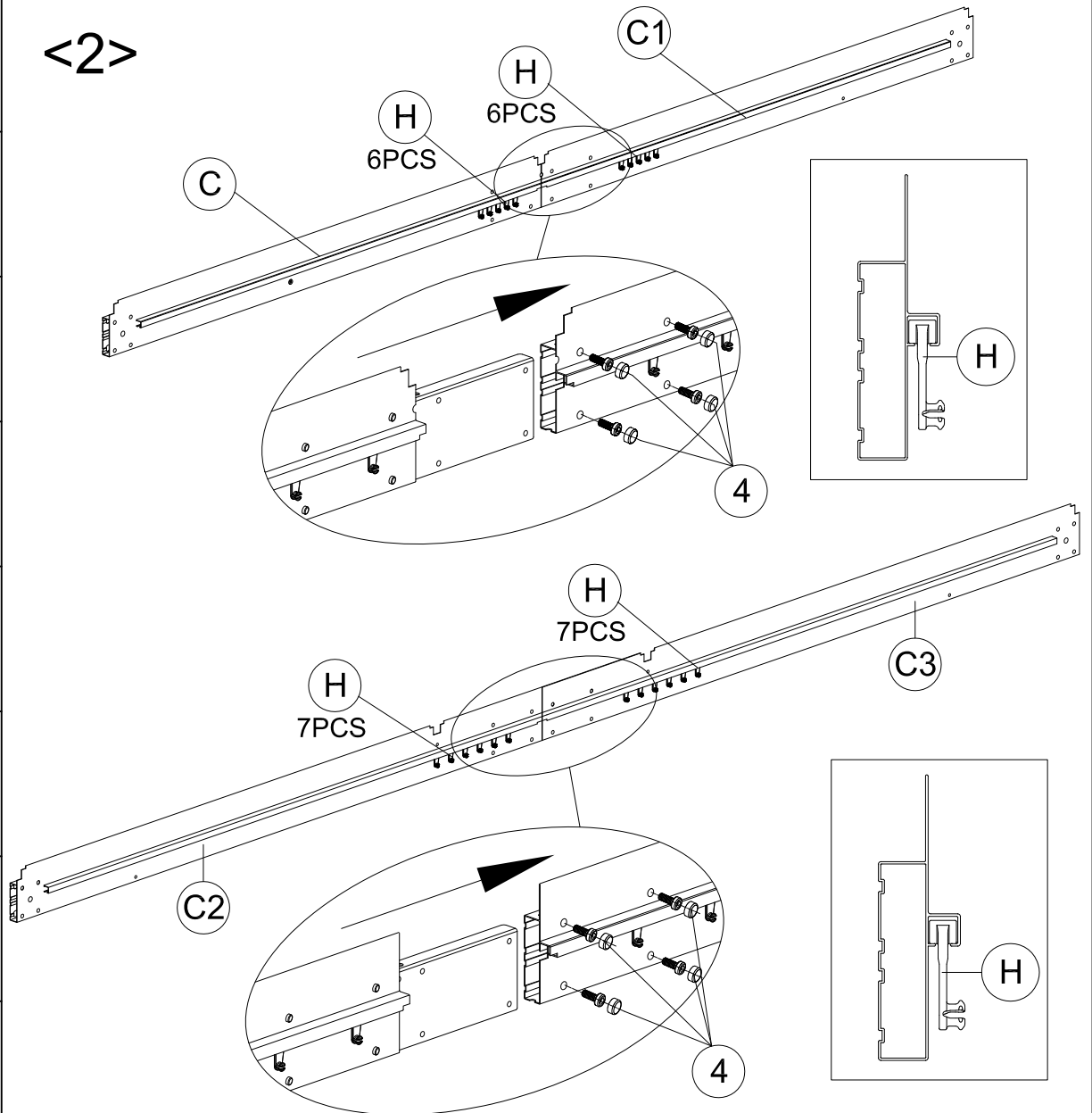



M6x16

3 32x

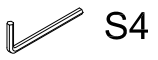

S4

T 1x

<3>

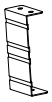
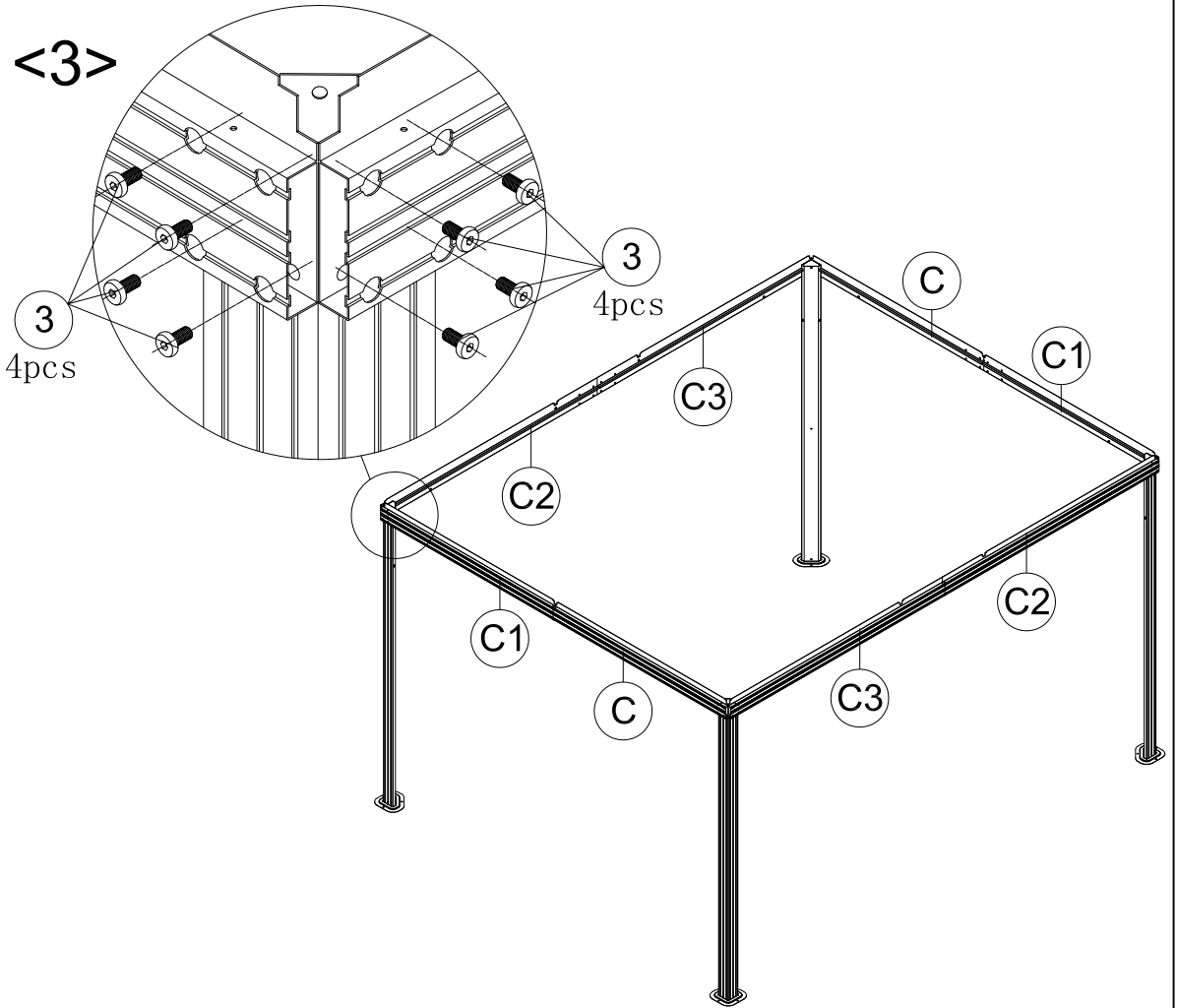

J 4x



K 4x

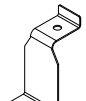

S 4x



M5x10

1 4x





ST4.2x12

2 24x

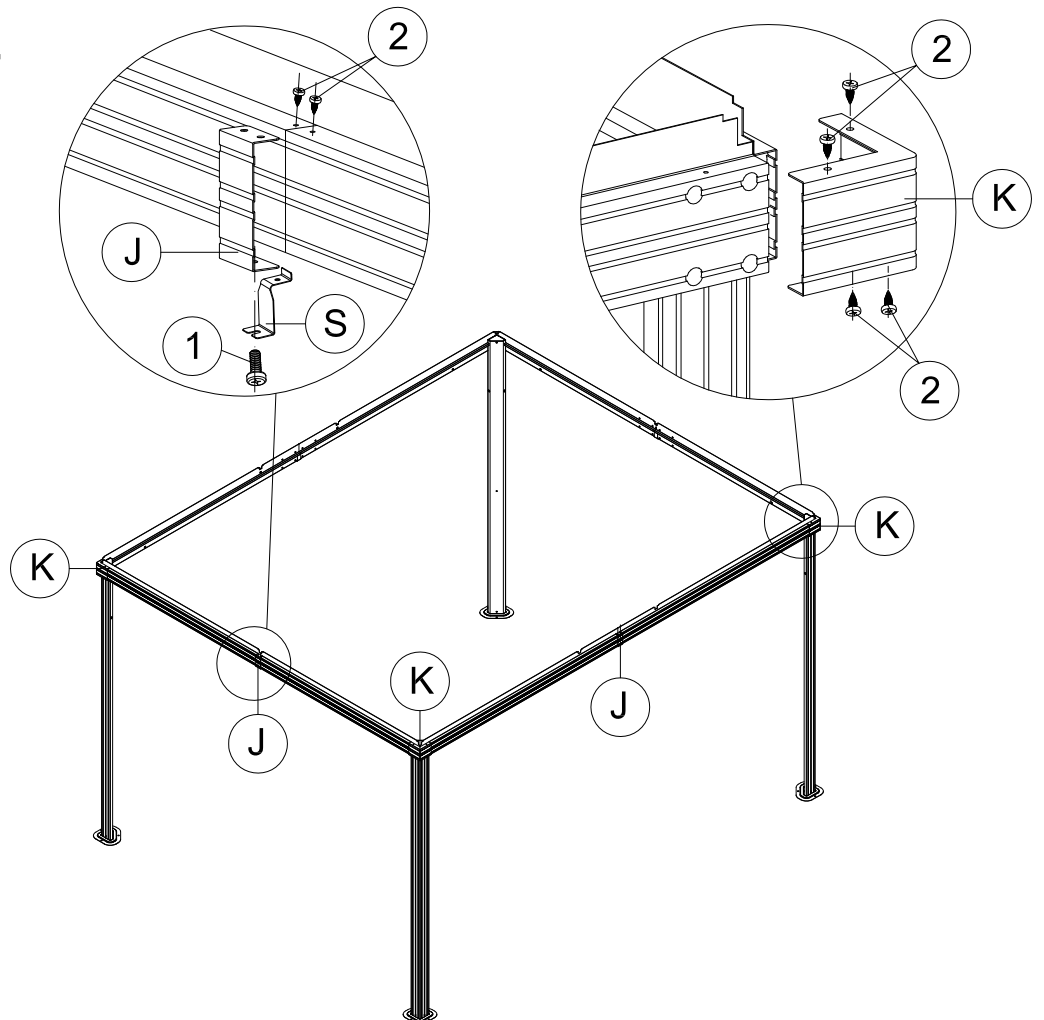

<4>

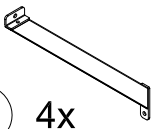
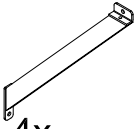

5

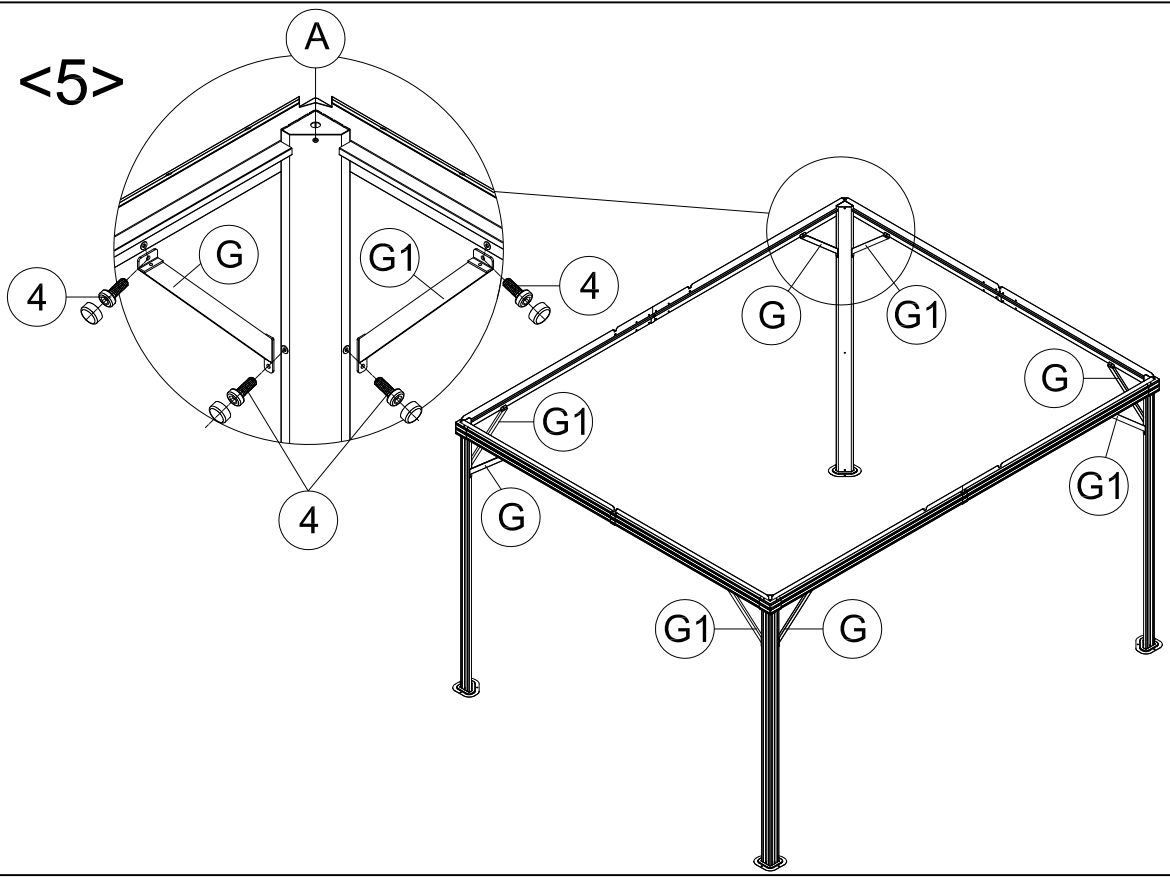
-  **G** 4x
-  **G1** 4x
-  **M6x12**
4 16x
-  **S4**
T 1x

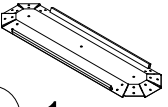

-  **D** 4x
-  **L** 1x
-  **M6x12**
4 8x
-  **S4**
T 1x

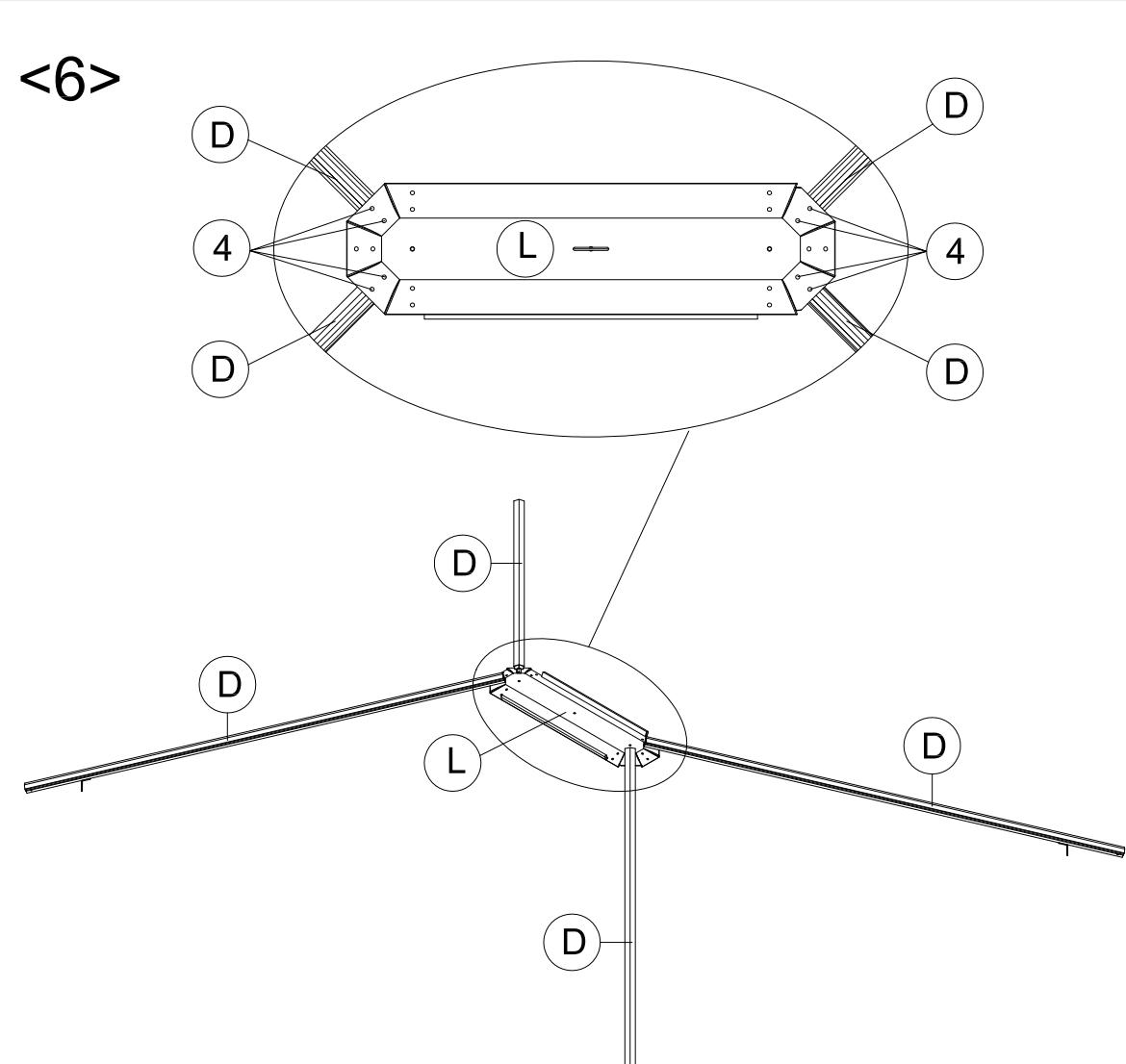

6



D1 6x

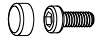

M6x12

4 22x



S4

T 1x

<7>

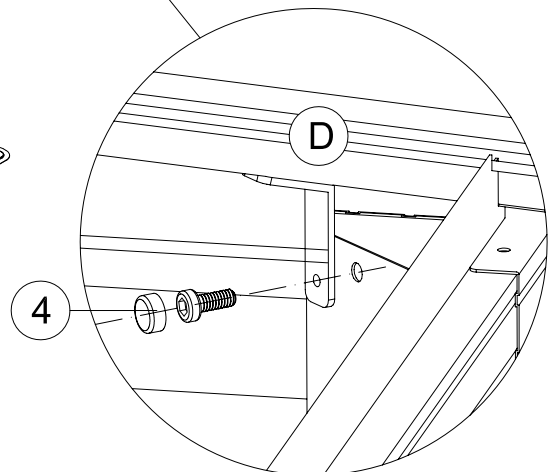
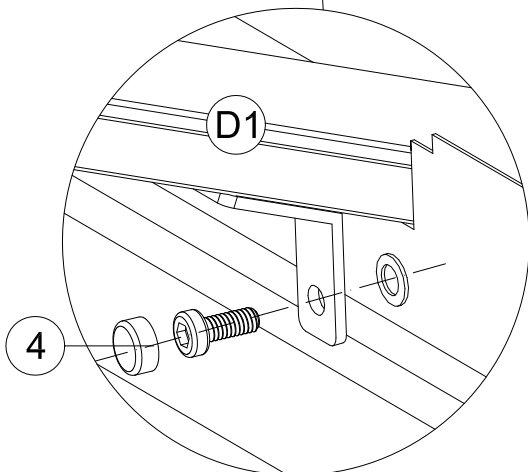
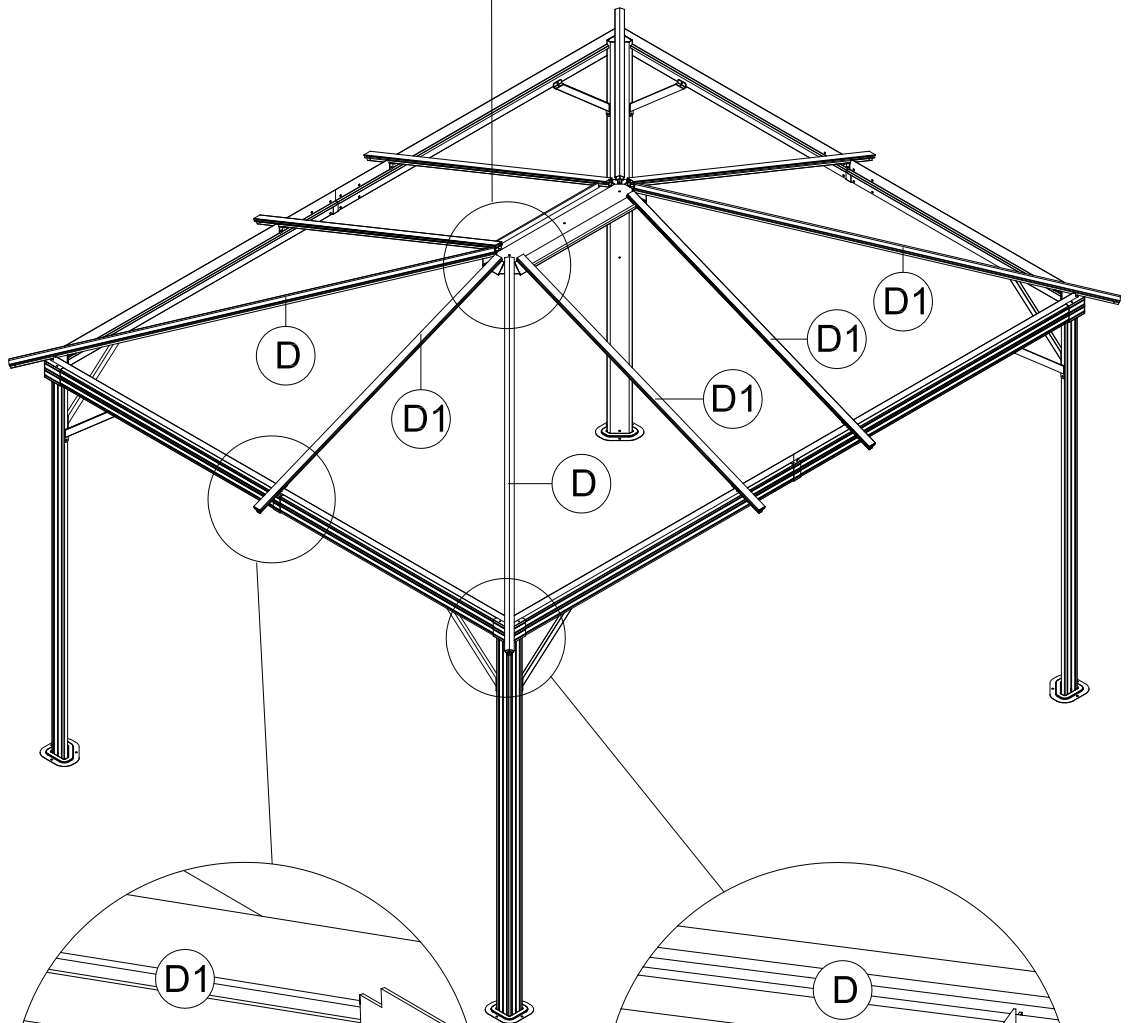
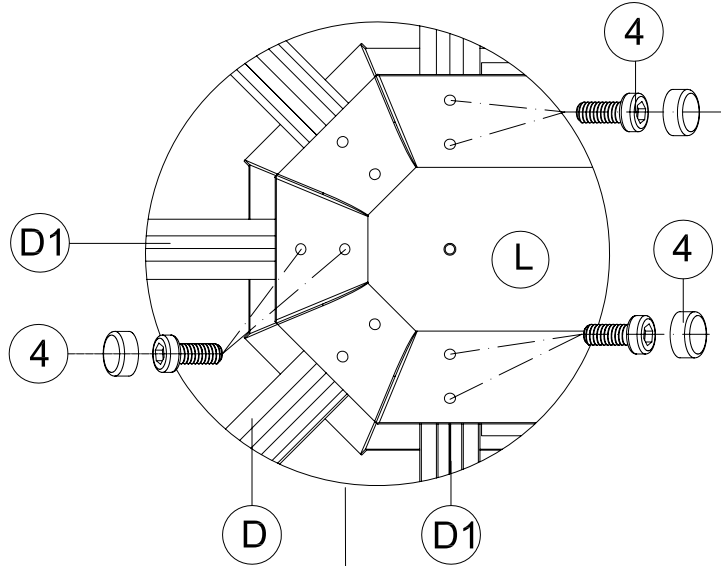

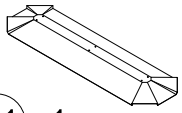

L1 1x



M6x20

5 3x



S4

T 1x

<8>

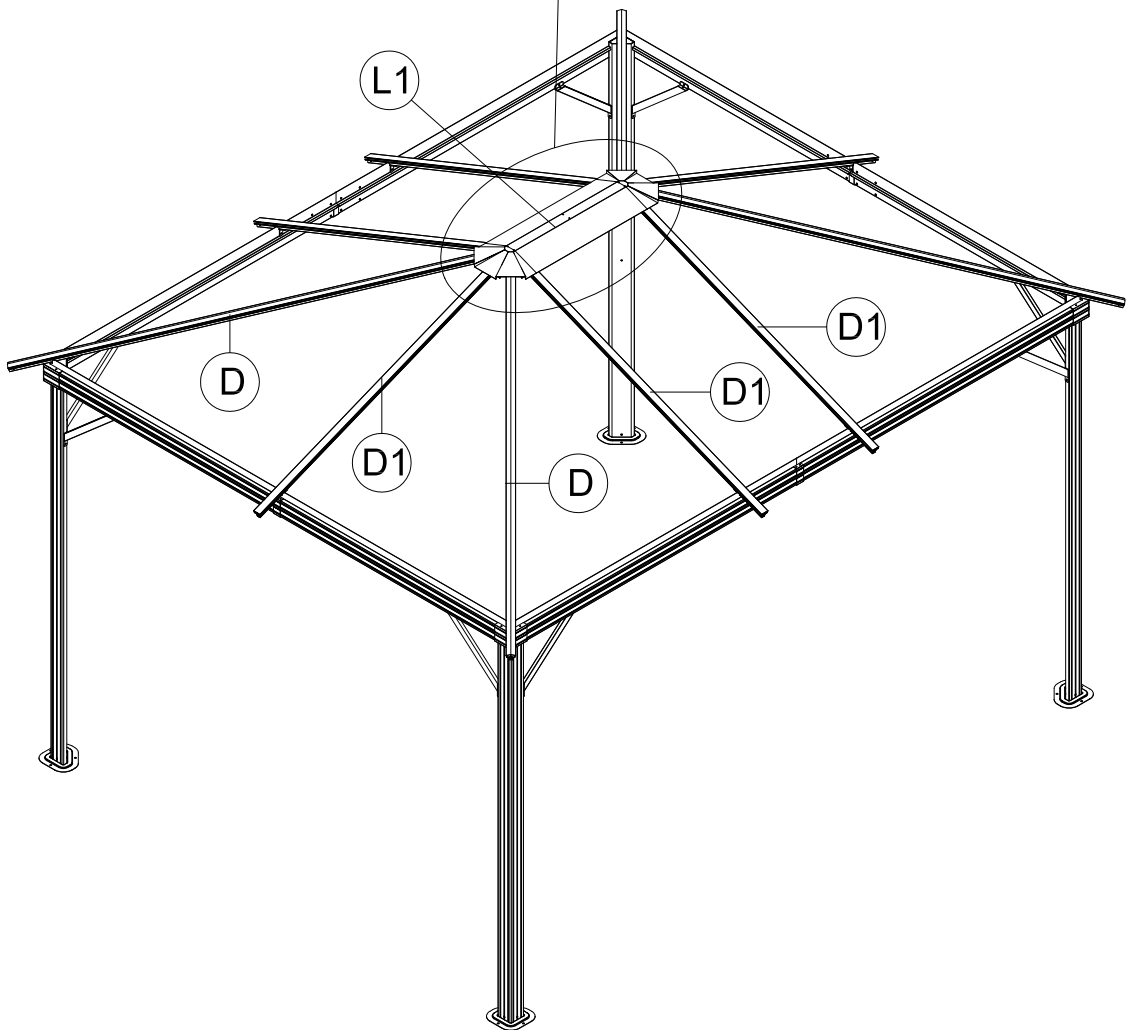
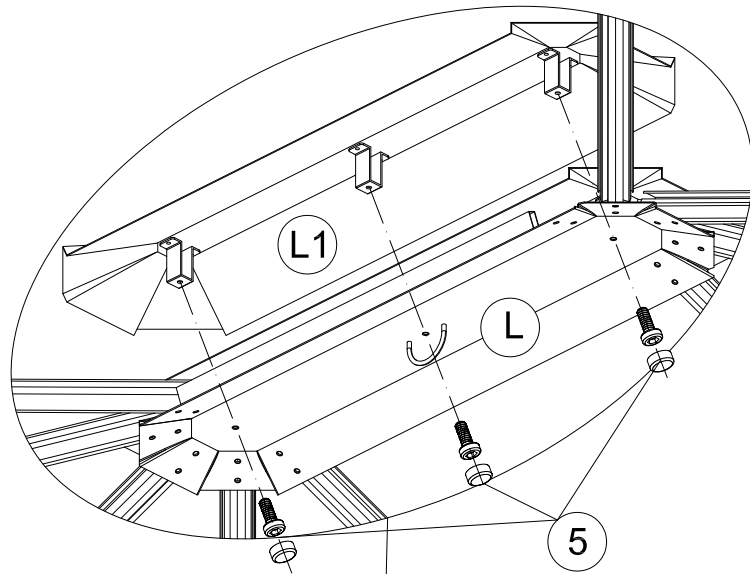

<9>

- E 4x
- E1 4x
- E2 2x
- N 4x
- N1 4x
- Q 2x

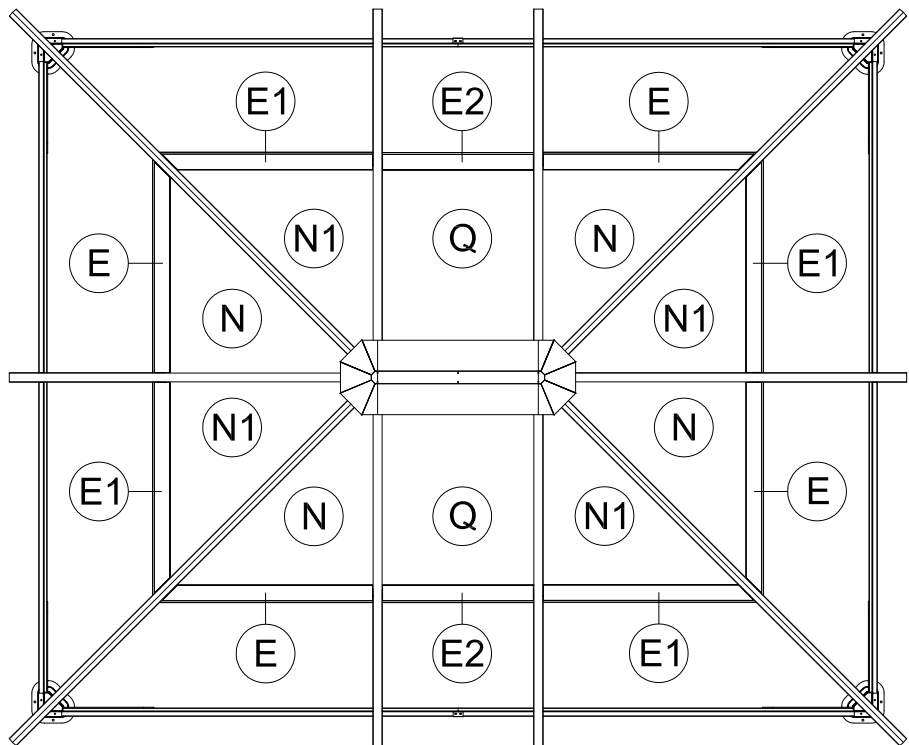
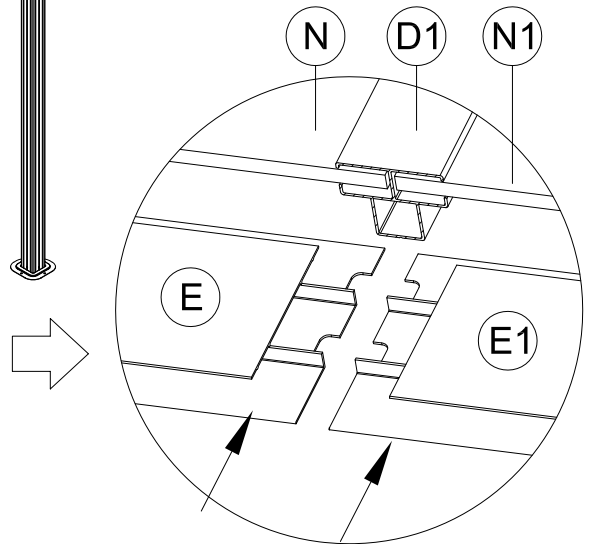
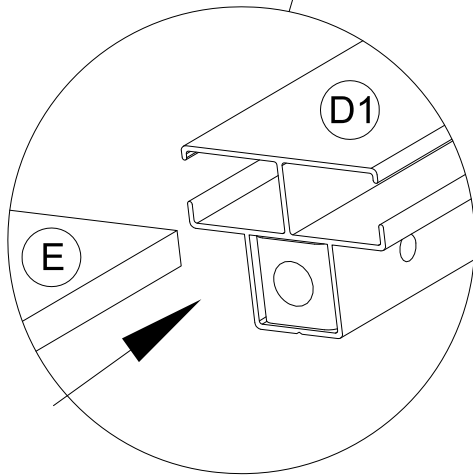
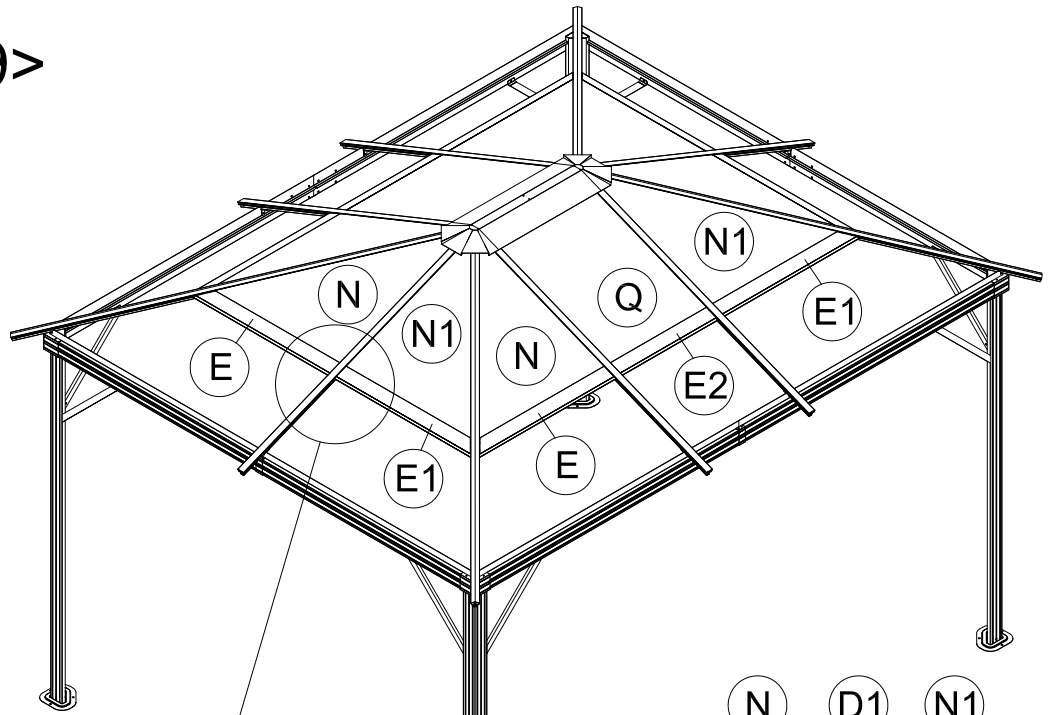

<10>

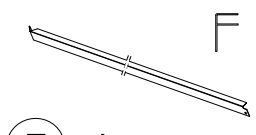

F 4x

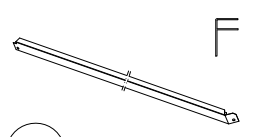

F1 4x

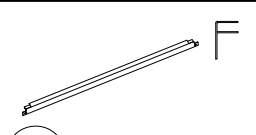

F2 2x

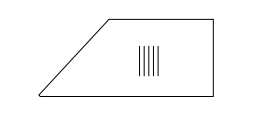

P 4x

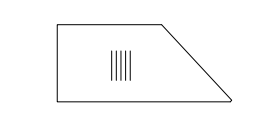

P1 4x

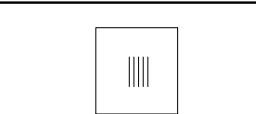

Q1 2x



M 6x



M1 4x

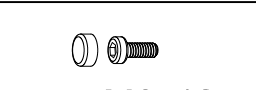

M6x12

4 10x



T 1x

10

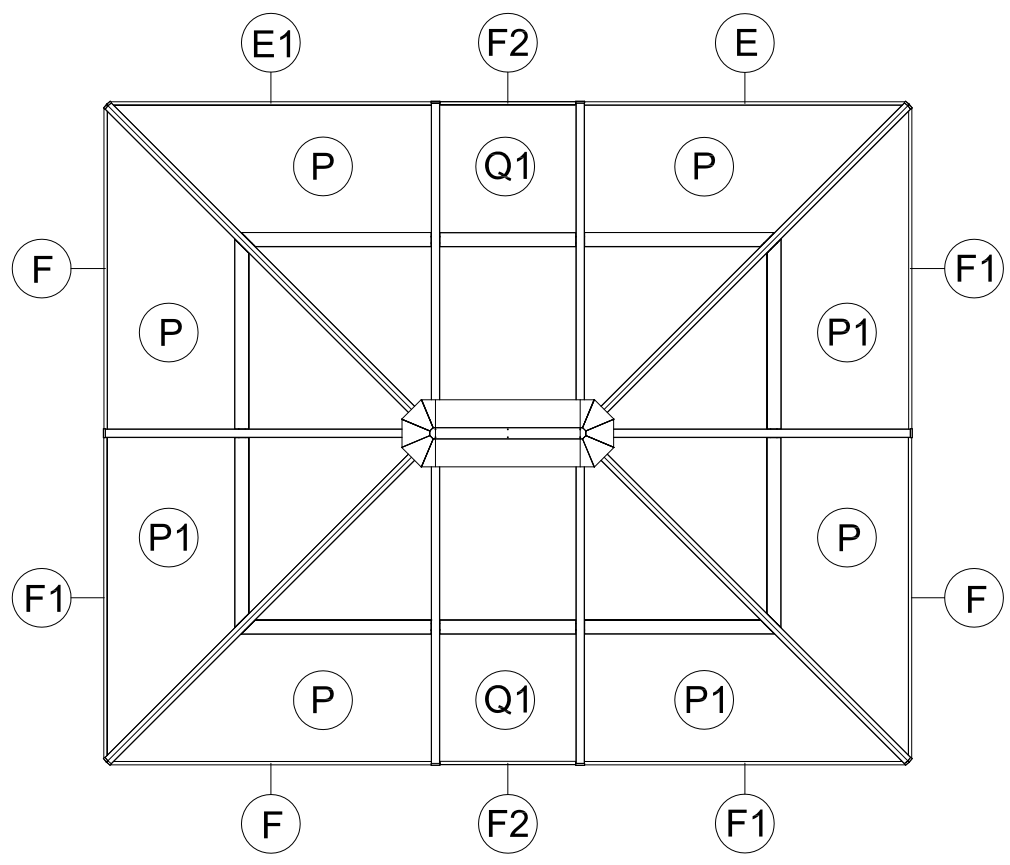
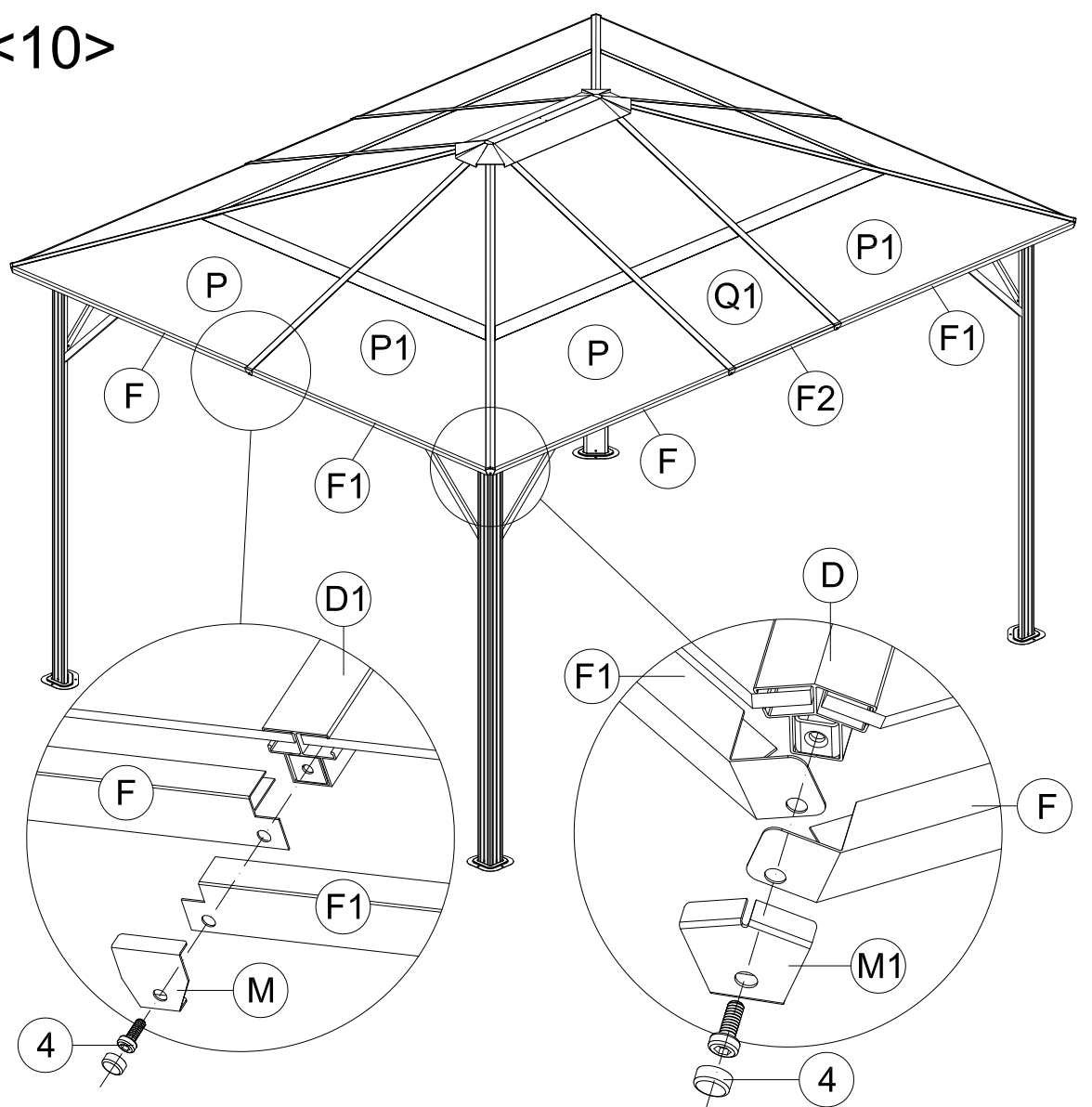

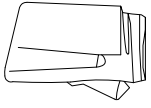

(R) 4x

<11>

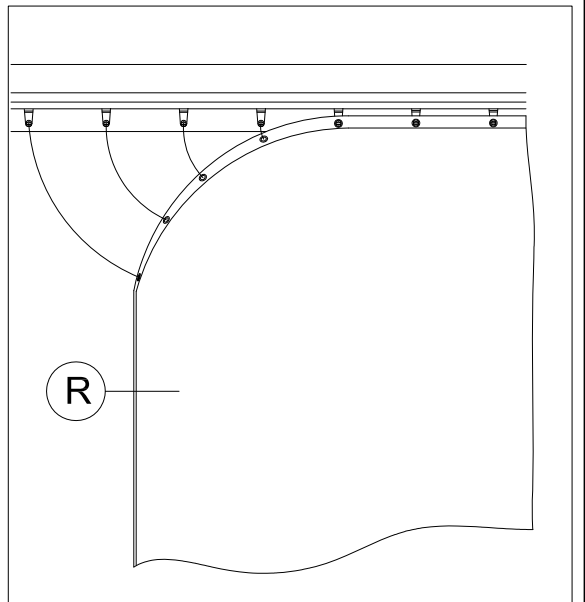
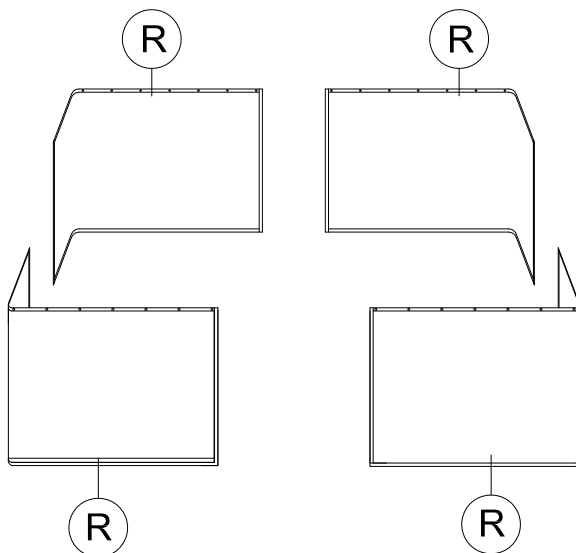
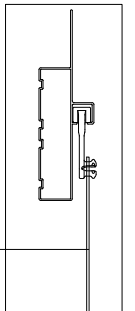
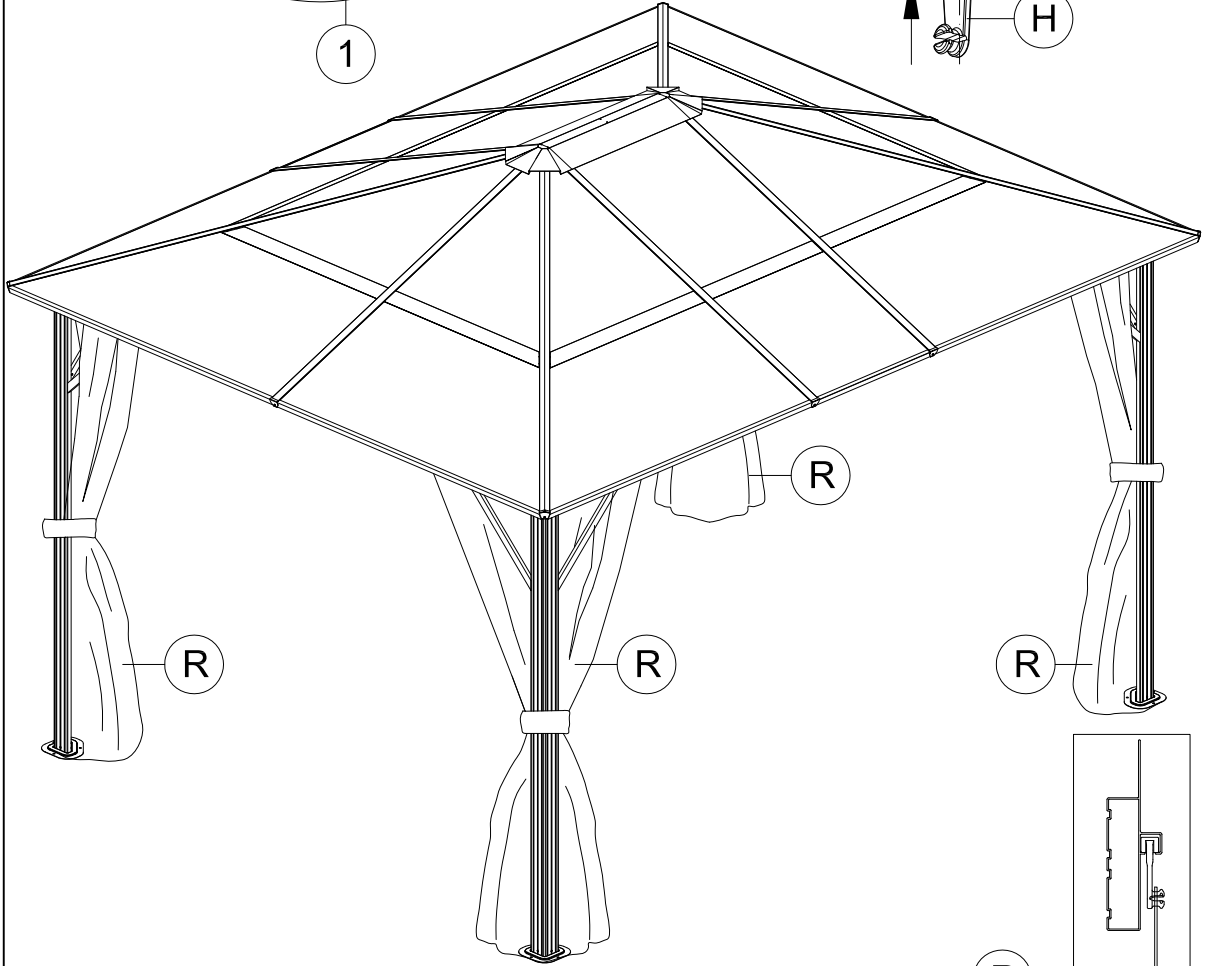
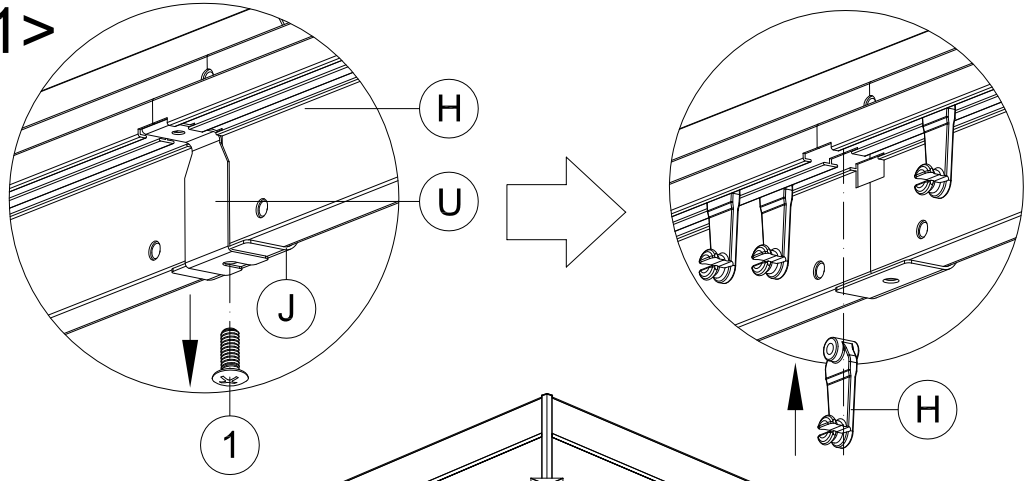



<12>

U 8x

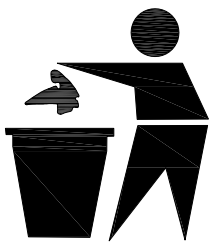
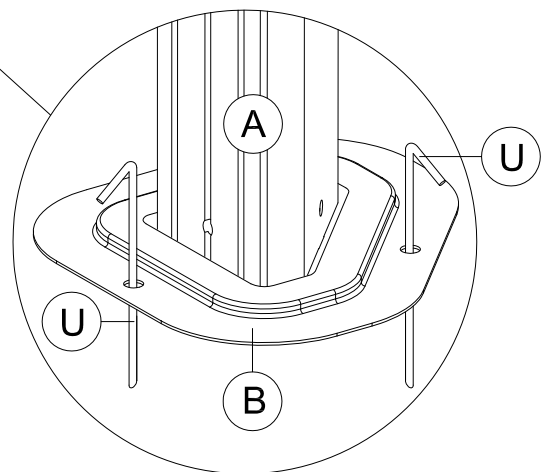
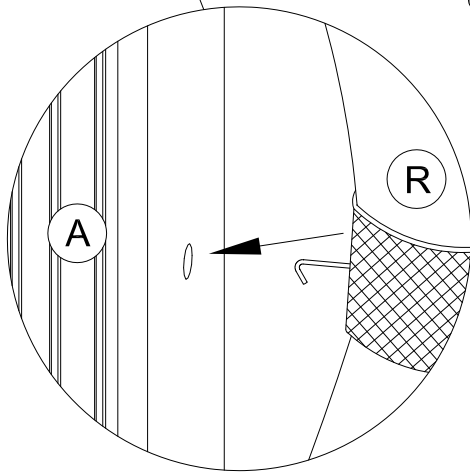
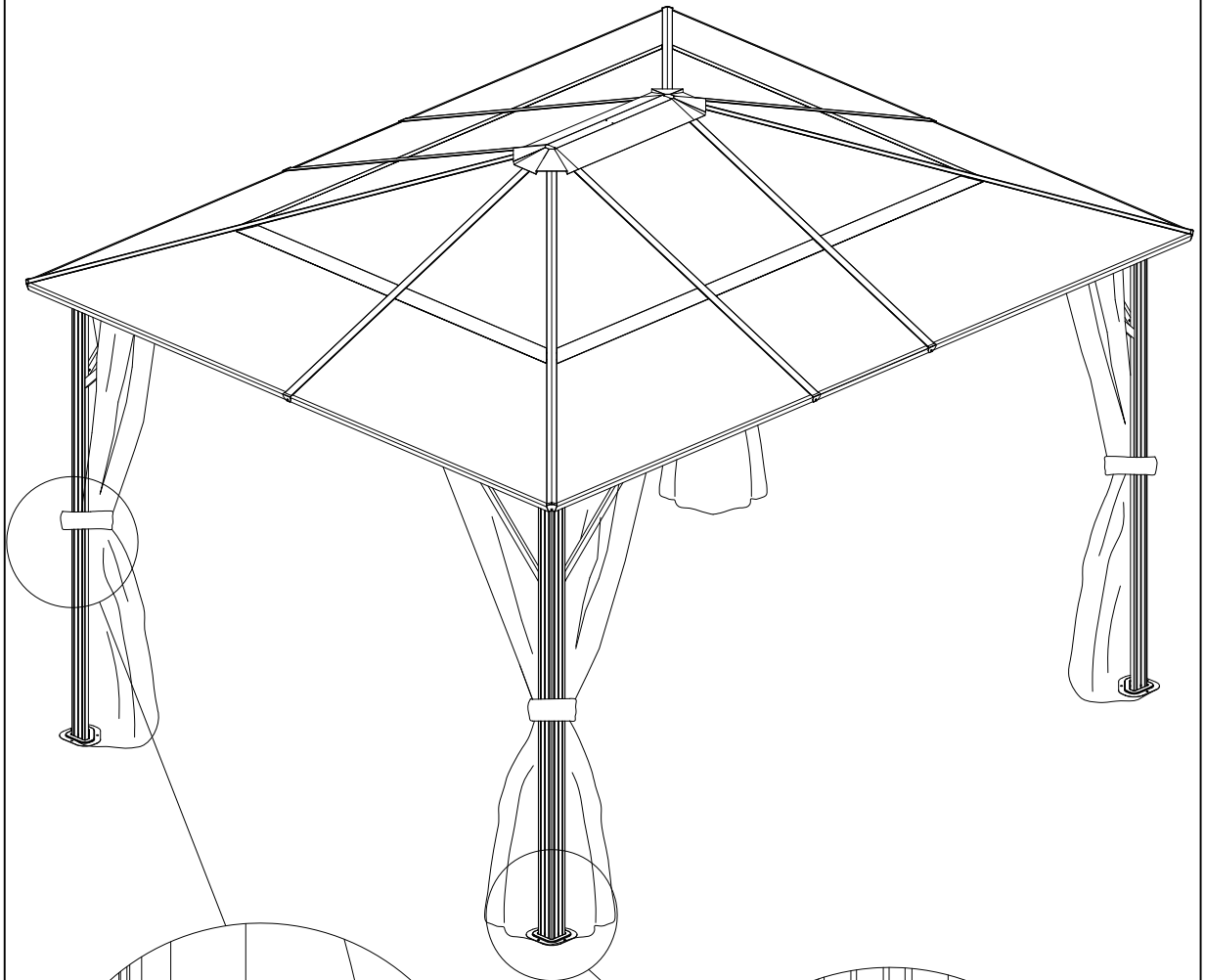

12