



SCHELLENBERG

CABLESYSTEM M

 20027, 20028





20027

A

2x



B

3x



C

2x



D

1x



E

14x



F

1x

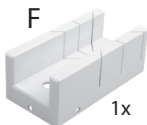



20028

A



2x

B



2x

E



10x

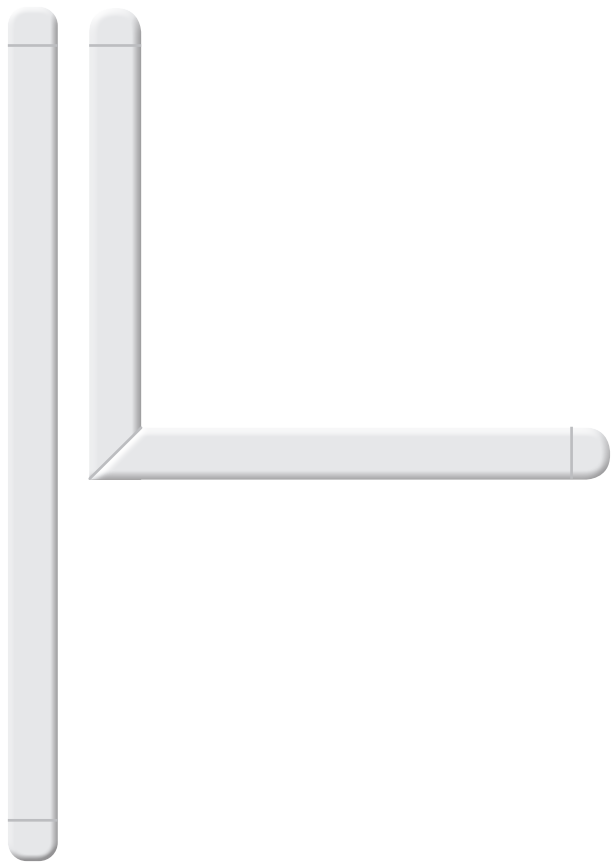

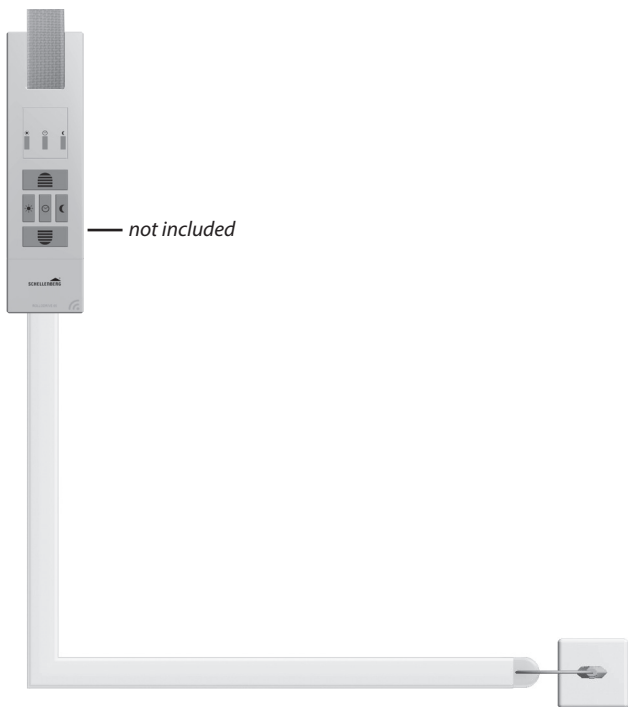

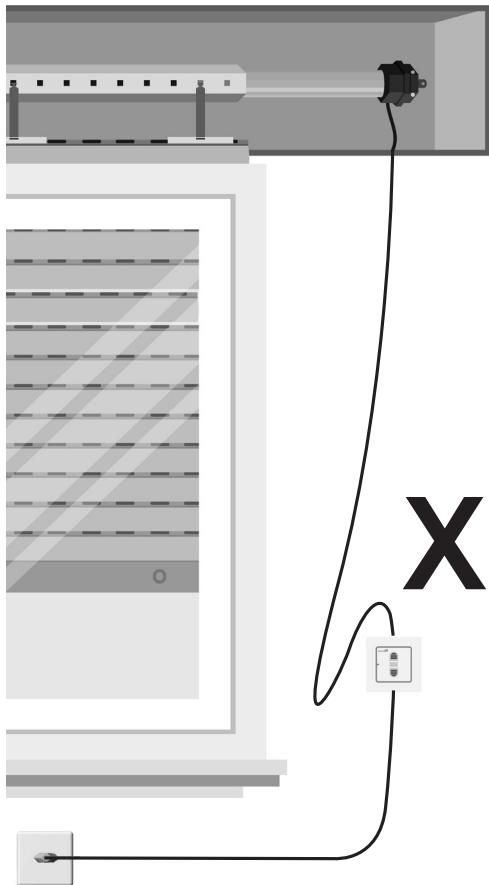

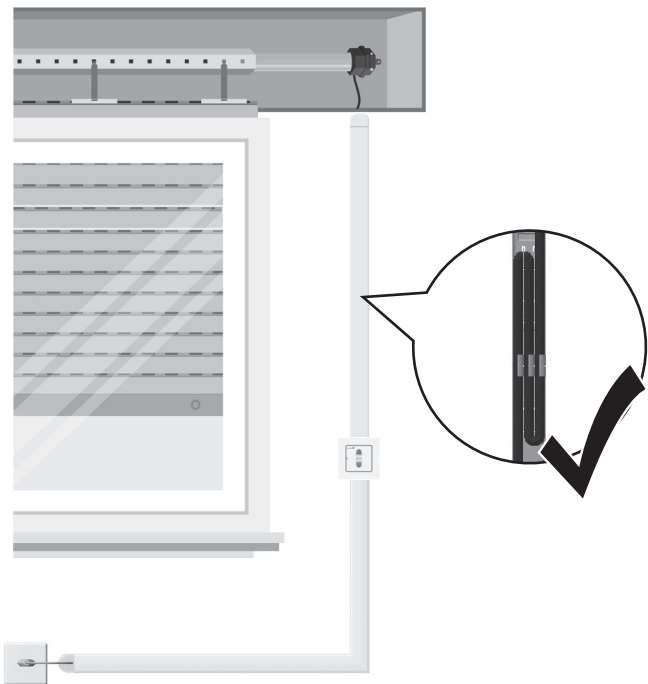



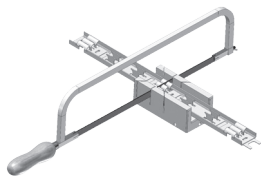
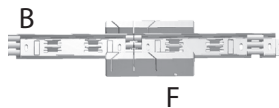

A

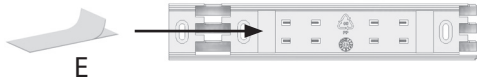

B





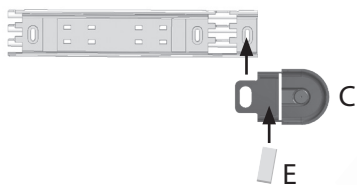
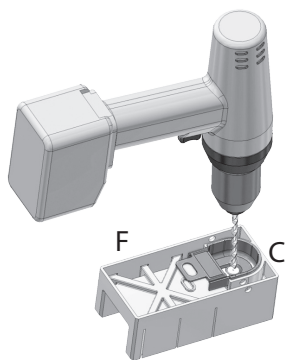

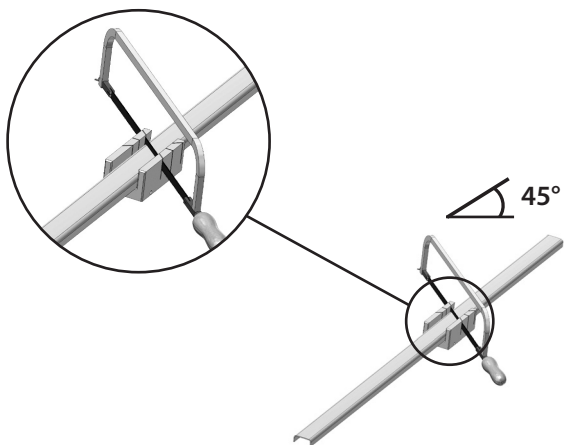
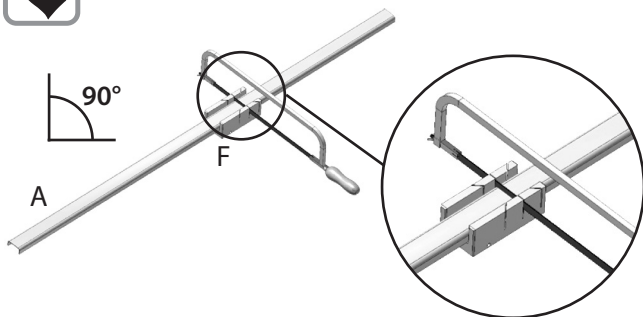

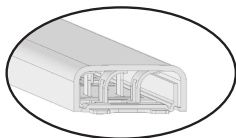

A

1.



2.



3.



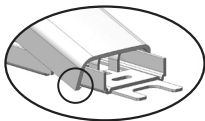

B

1.



2.

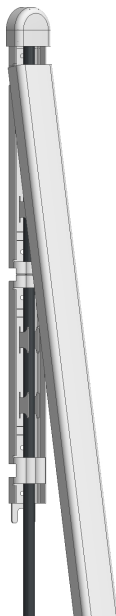

3.



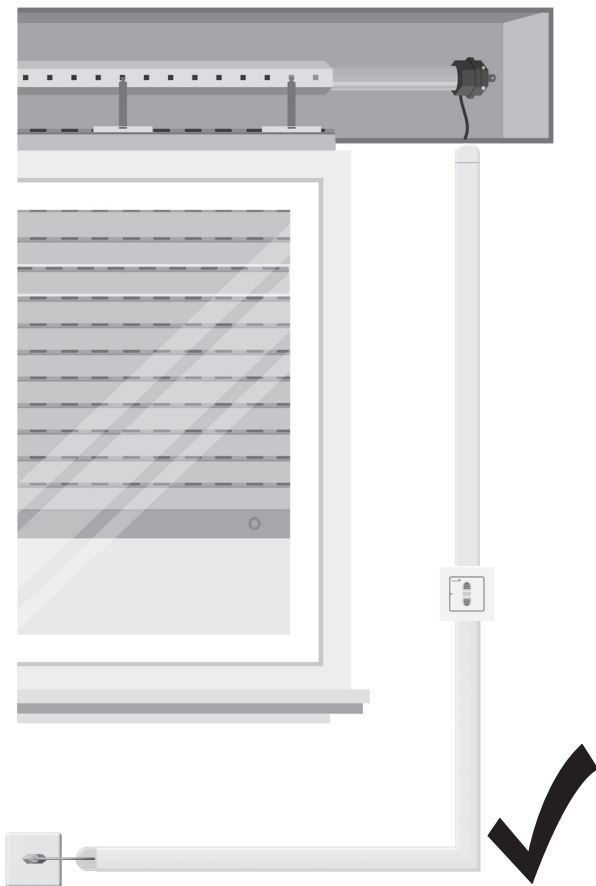



Alfred Schellenberg GmbH

An den Weiden 31
D-57078 Siegen
service.int@schellenberg.de
www.schellenberg.de

Mo. - Fr.: 7.30 Uhr - 21.00 Uhr
Sa.: 8.00 Uhr - 14.00 Uhr
Tel.: +49 (0)271 89056-444
Fax.: +49 (0)271 89056-398