

MORRIS
8141/2500/5032/1073
1071-5031/2500/8142

- | | | | |
|-----------|--|-----------|---|
| D | MONTAGEANLEITUNG
BEDIENUNGSANLEITUNG | GB | ASSEMBLY INSTRUCTIONS
INSTRUCTION MANUAL |
| NL | HANDLEIDING VOOR DE MONTAGE
GEBRUIKSAANWIJZING | PL | INSTRUKCJA MONTAŻU
INSTRUKCJA OBSŁUGI |
| TR | MONTAJ TALIMATI
KULLANIM KLAVUZU | RU | ИНСТРУКЦИЯ ПО МОНТАЖУ
ИНСТРУКЦИЯ ПО ЭКСПЛУАТАЦИИ |
| RO | INSTRUCȚIUNI DE INSTALARE
INSTRUCȚIUNI DE UTILIZARE | IT | ISTRUZIONI DI MONTAGGIO
MANUALE DI ISTRUZIONI |
| FR | NOTICE DE MONTAGE
MANUEL INSTRUCTIONS | SK | MONTÁŽNY NÁVOD
NÁVOD NA POUŽITIE |
| HU | KÖZGYŰLÉS UTASÍTÁSOK
KEZELÉSI UTASÍTÁS | CZ | MONTÁŽNÍ NÁVOD
NÁVOD K POUŽITÍ |
| SI | NAVODILA ZA MONTAŽO
NAVODILA ZA UPORABO | PT | INSTRUÇÕES DE MONTAGEM
MANUAL DO USUÁRIO |
| ES | INSTRUCCIONES DE MONTAJE
MANUAL DEL USUARIO | HR | UPUTE ZA MONTAŽU
UPUTE ZA UPOTREBU |

F/B

231005

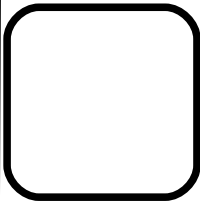
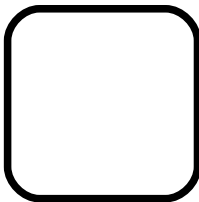

0019

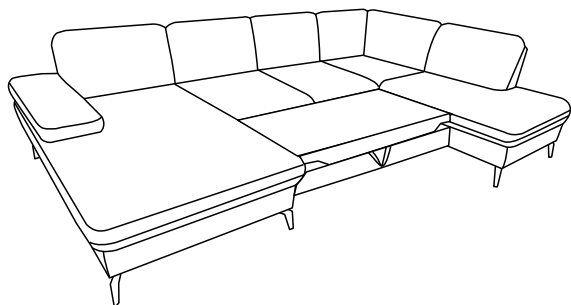
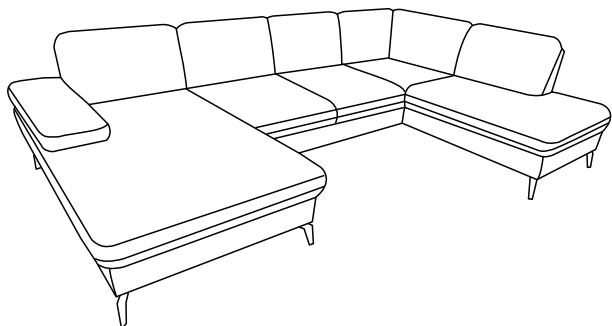

0019

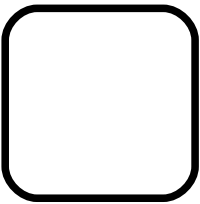
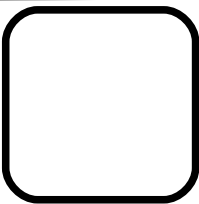

0089

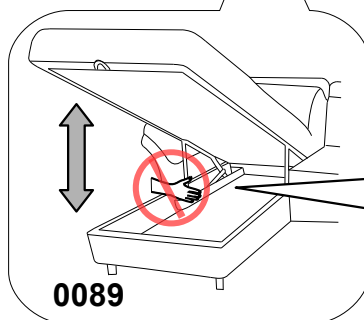
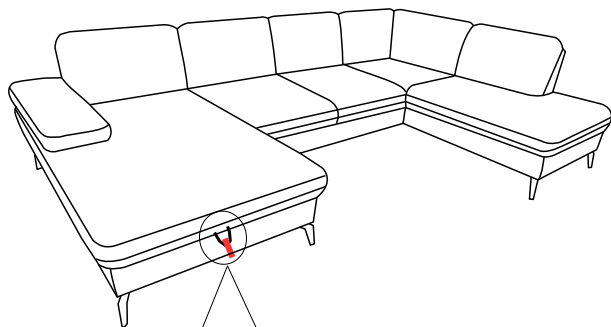
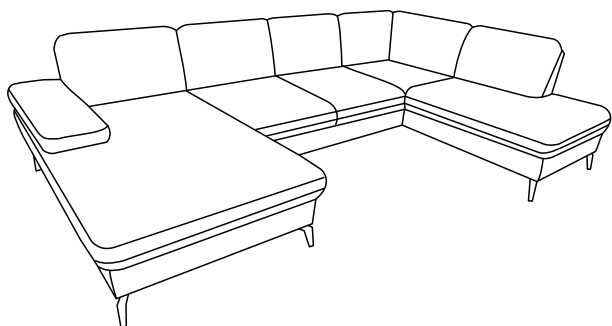
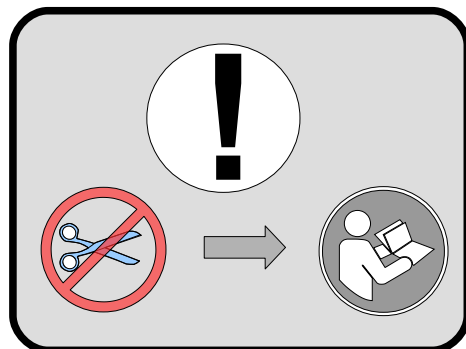

0089



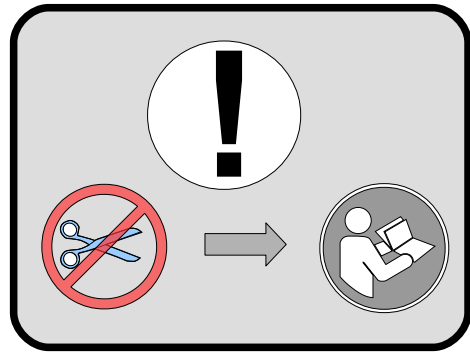
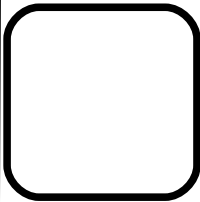
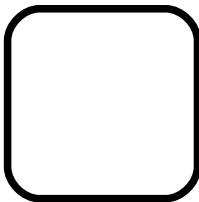

0089

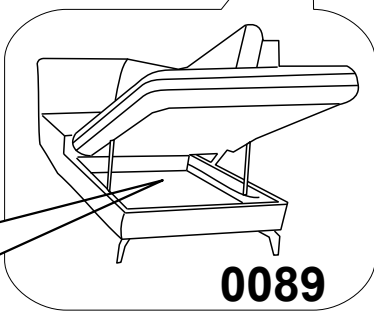
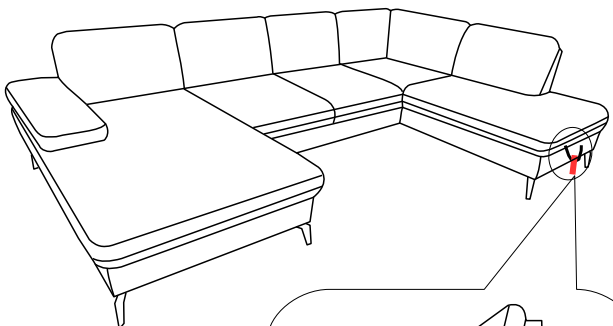
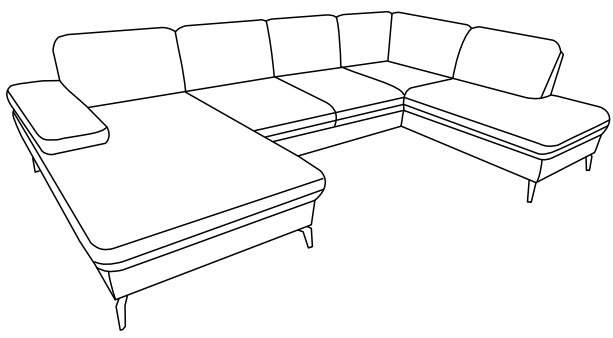

0089

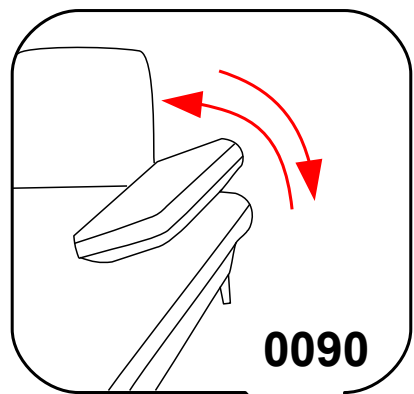
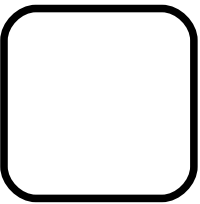
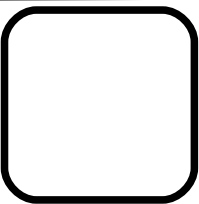

0090

0090

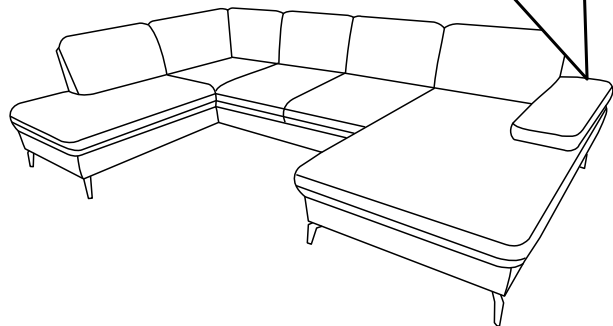
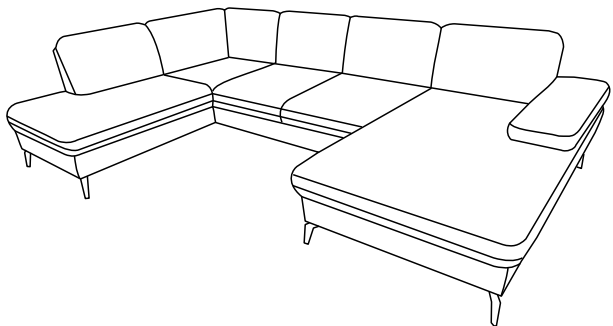

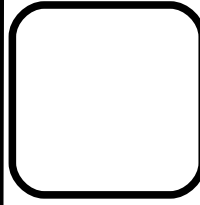
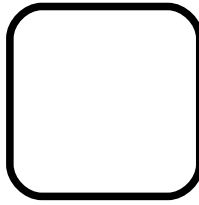

0037

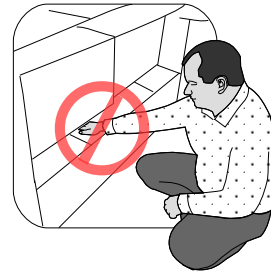
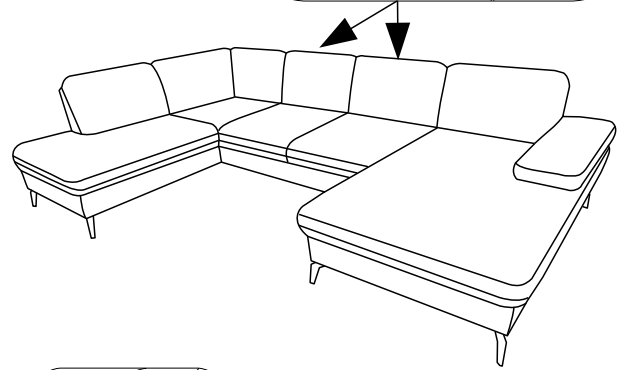
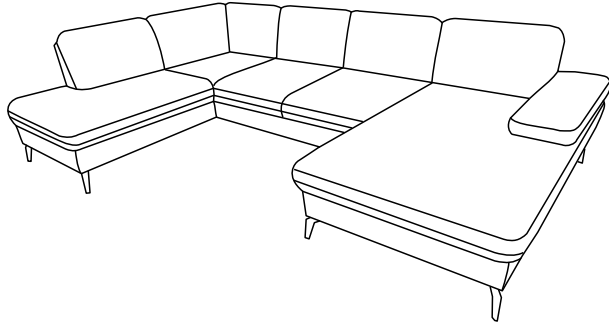
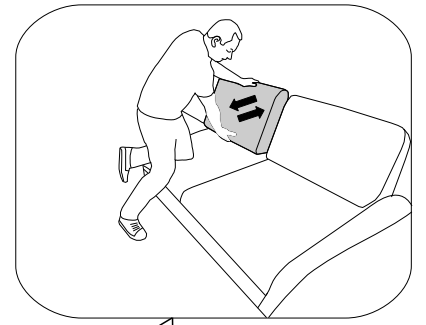

L

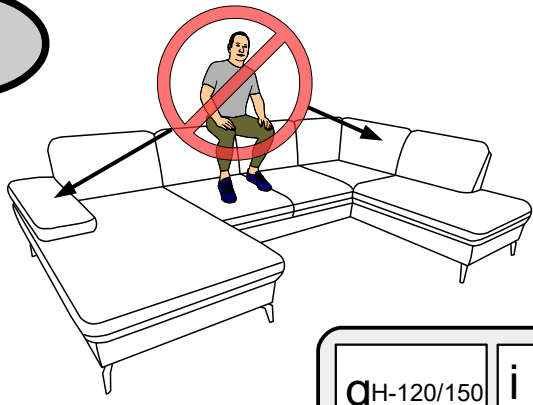

R

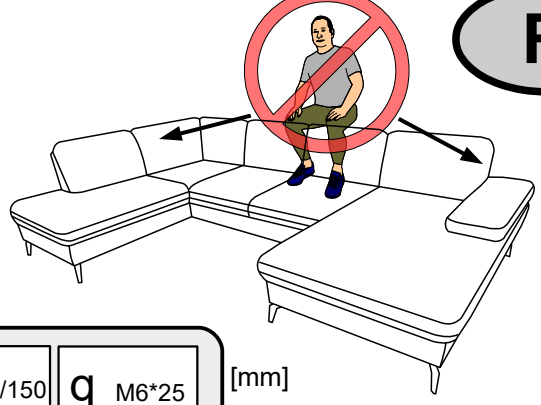

g ^{H-120/150} X2	i L-4 X1	S ^{H-120/150} s ₁ X2	q M6*25 [mm] X8
---	------------------------	--	-------------------------------

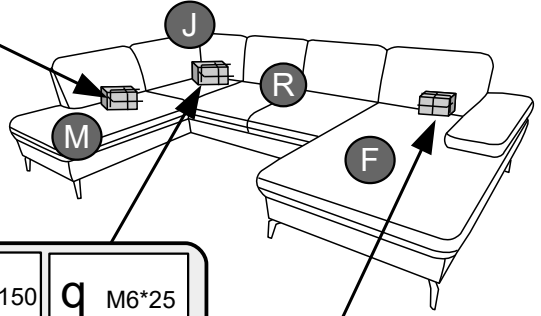
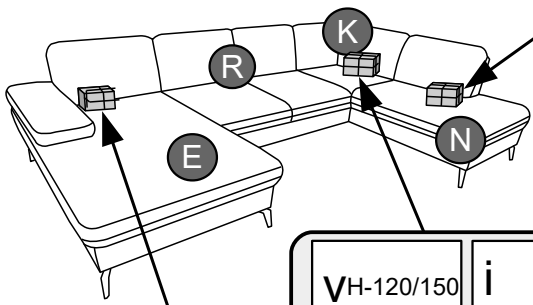



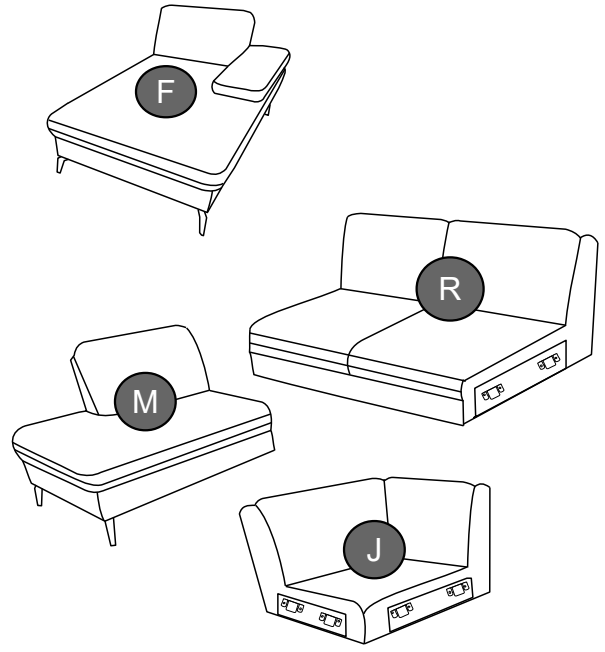
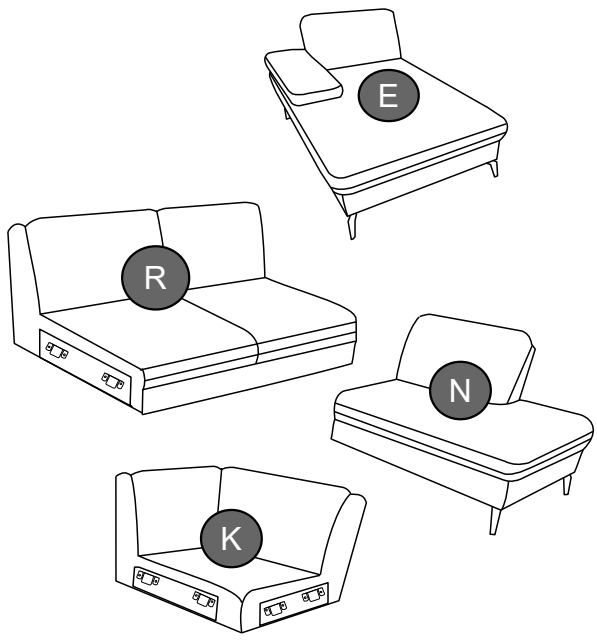
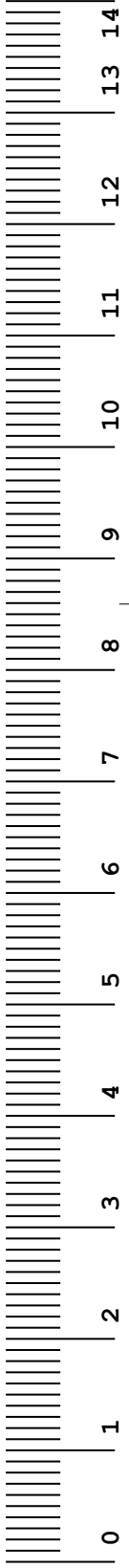

v ^{H-120/150} X3	i L-4 X1	S ^{H-120/150} s ₁ X1	q M6*25 X4
---	------------------------	--	--------------------------

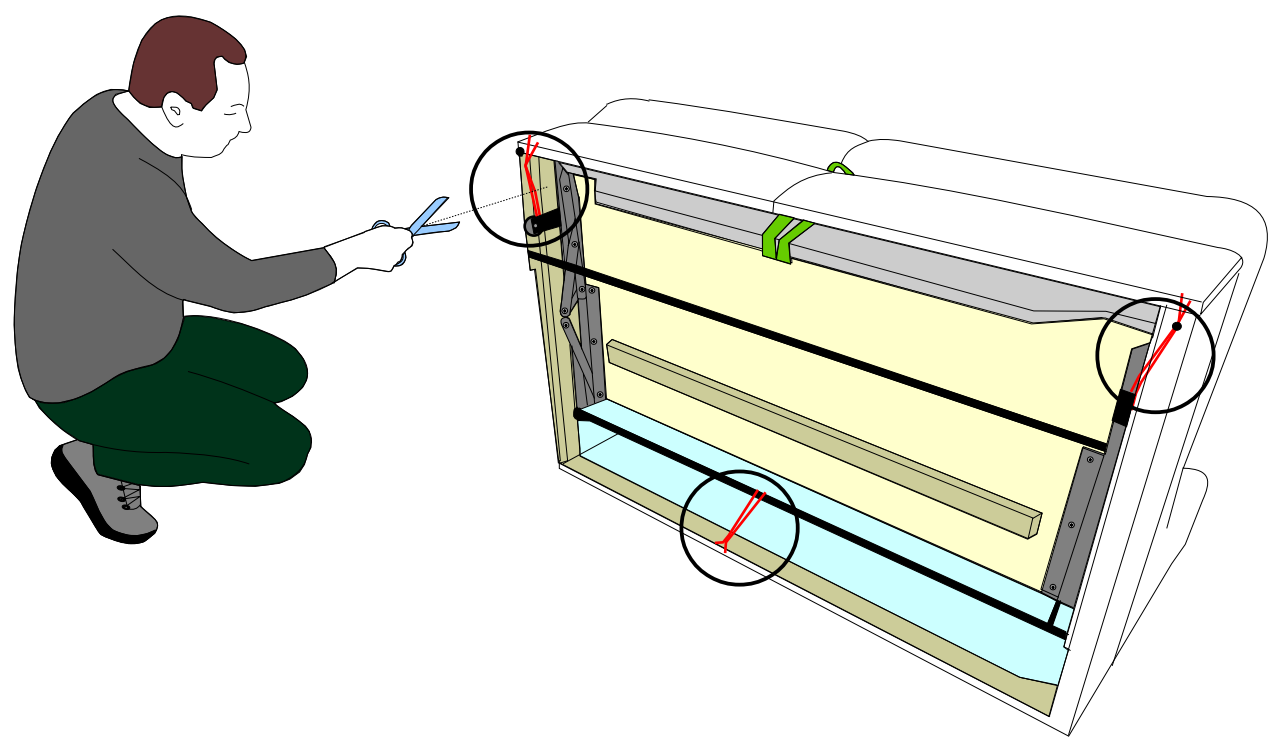
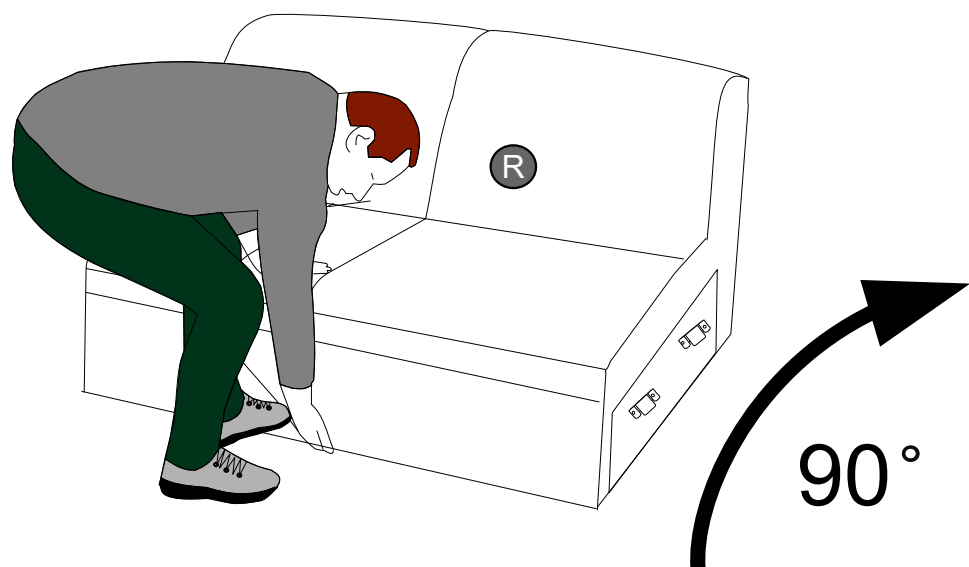
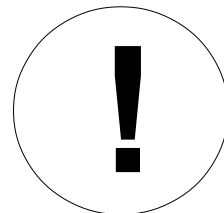
g ^{H-120/150} X2	v ^{H-120/150} X1	i L-4 X1	S ^{H-120/150} s ₁ X3	q M6*25 X12
---	---	------------------------	--	---------------------------



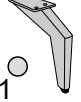

0019

g H-120/150 	v H-120/150 	i L-4 	S H-120/150  S ₁ 	q M6*25 
X4	X4	X1	X6	X24

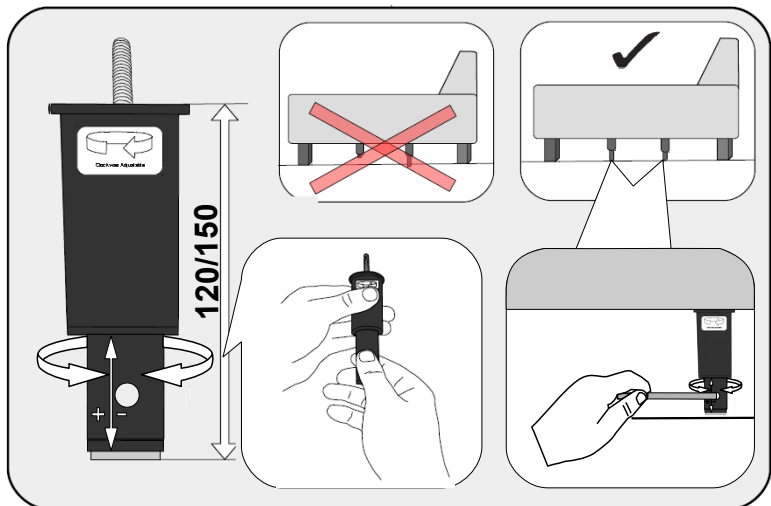
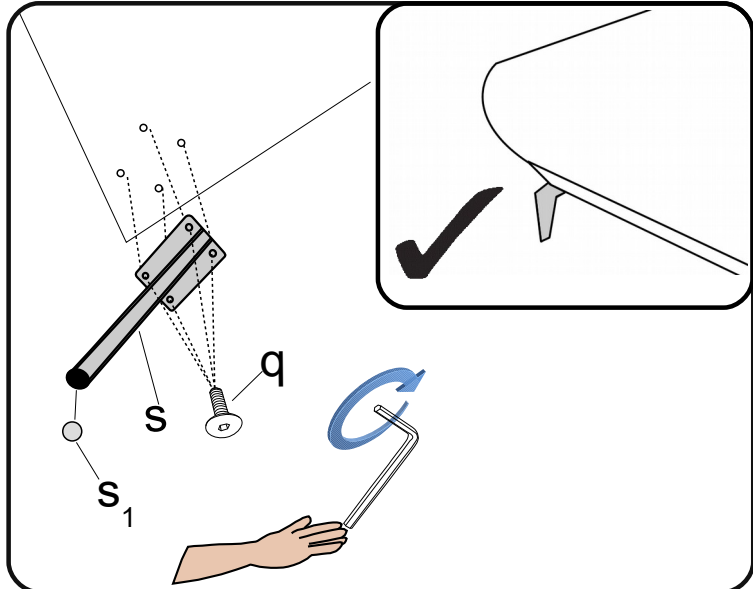
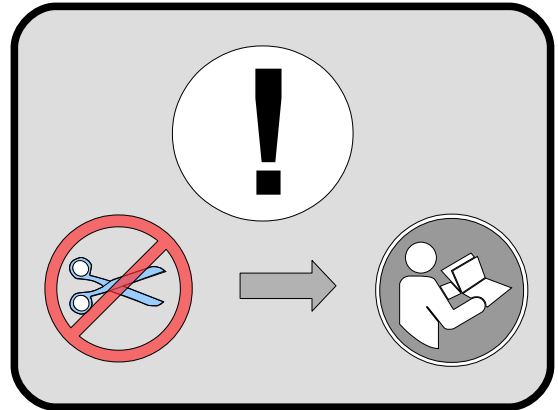
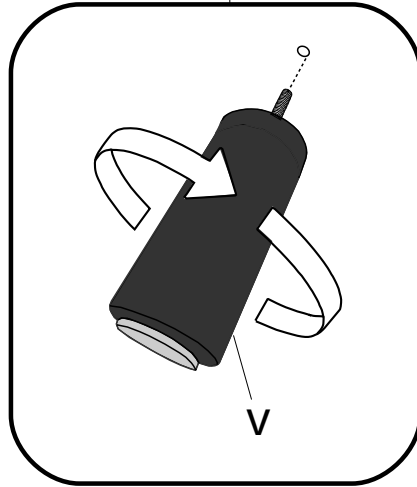
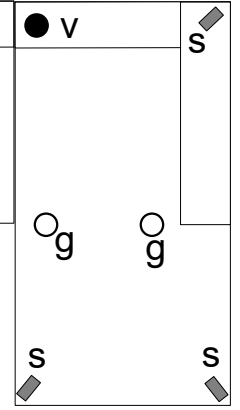
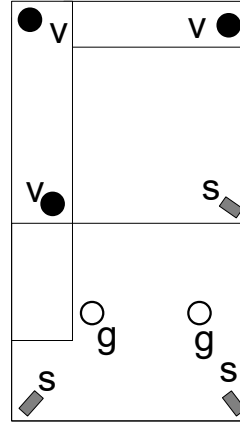
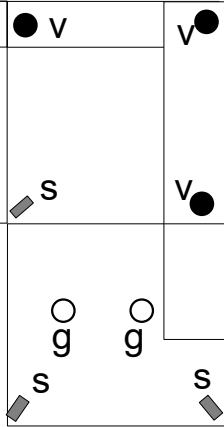
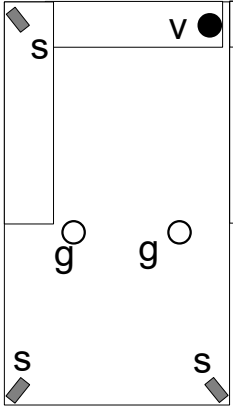
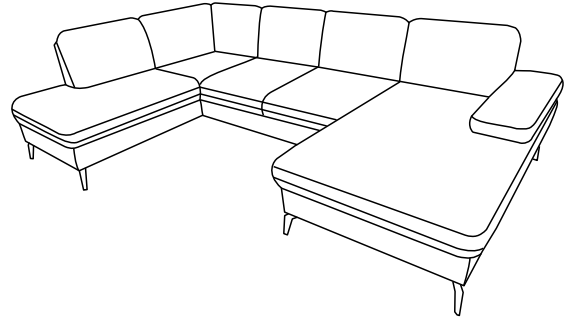
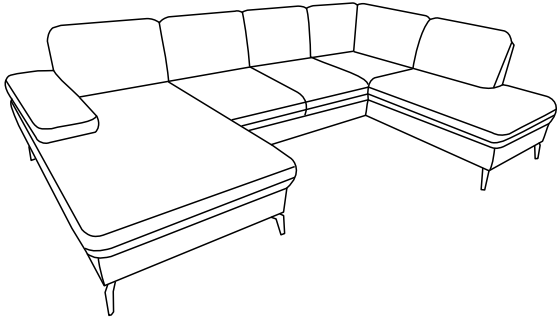

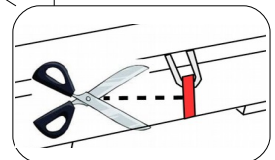
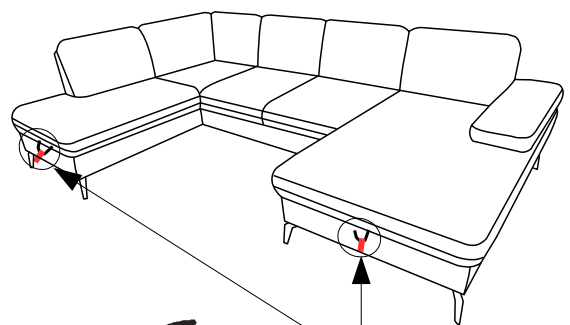
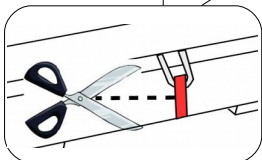
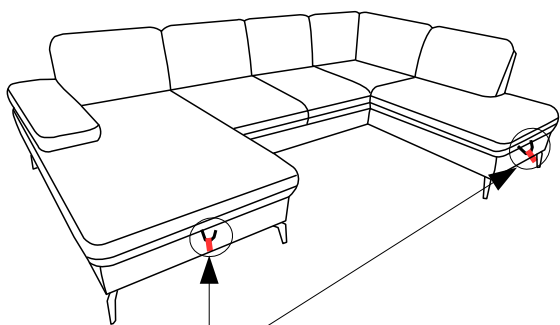
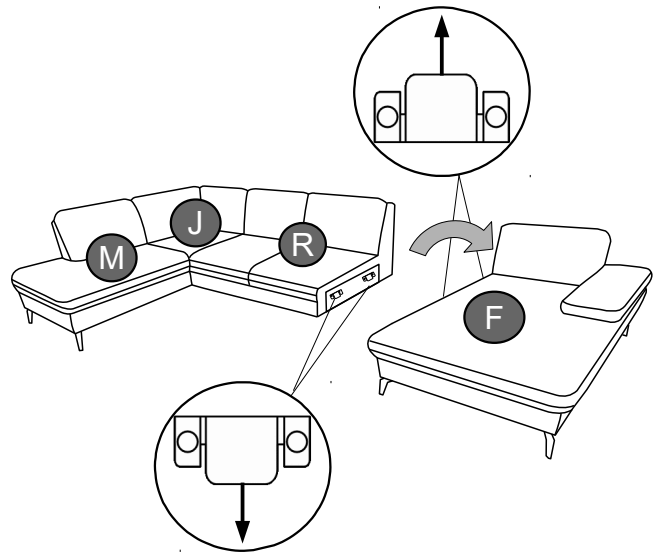
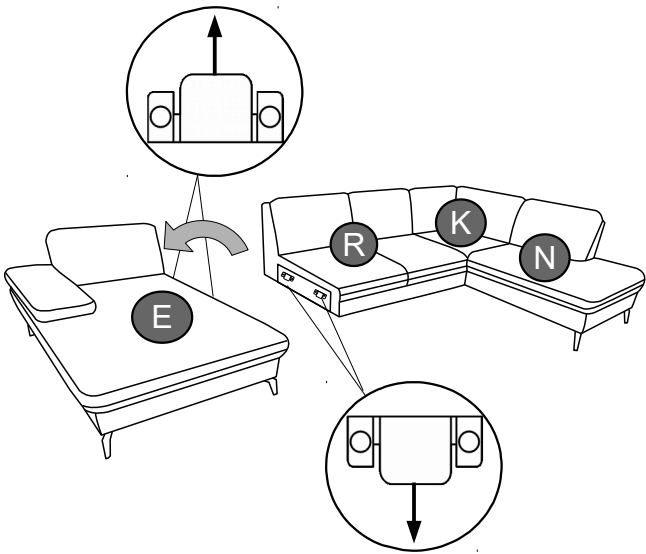
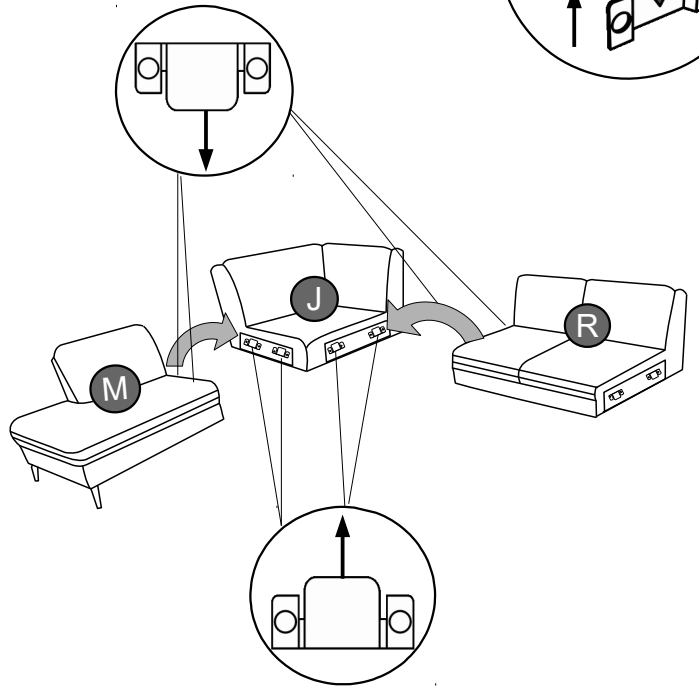
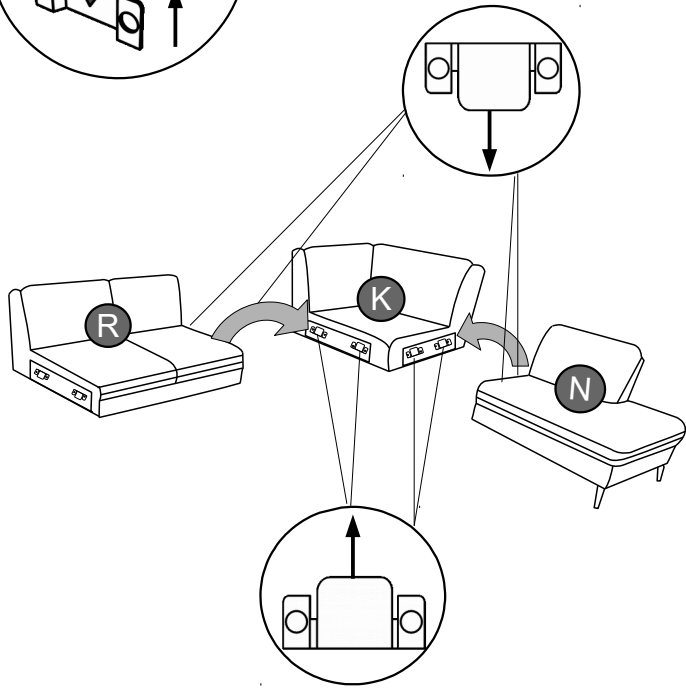
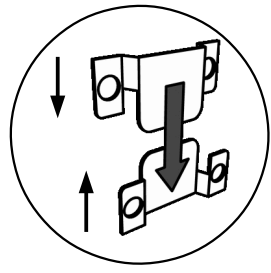
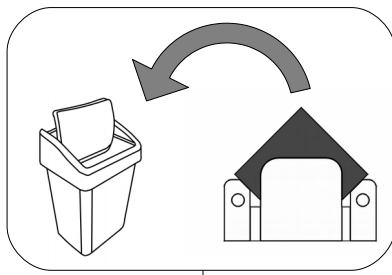
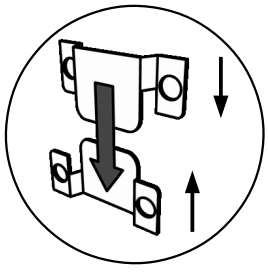

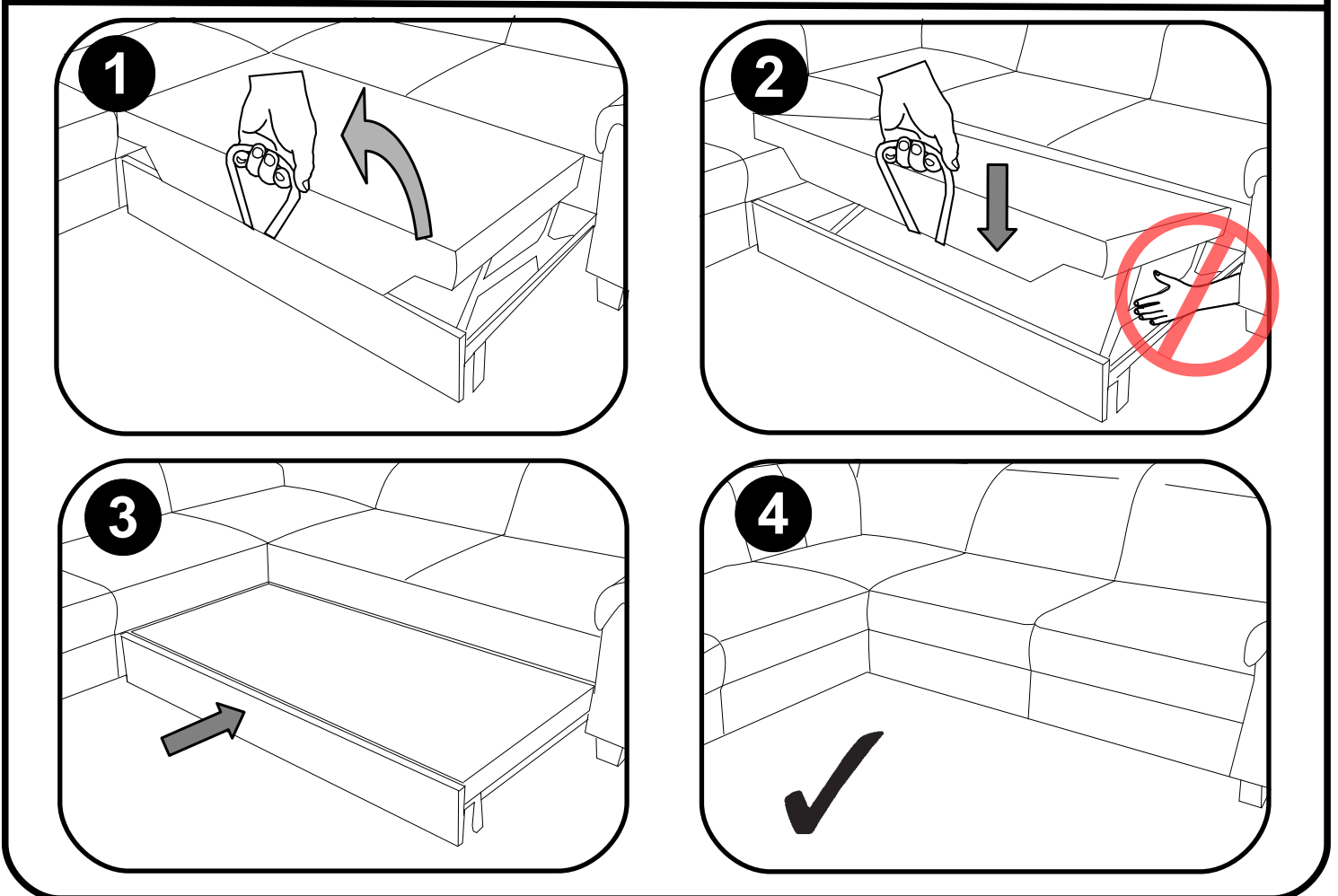
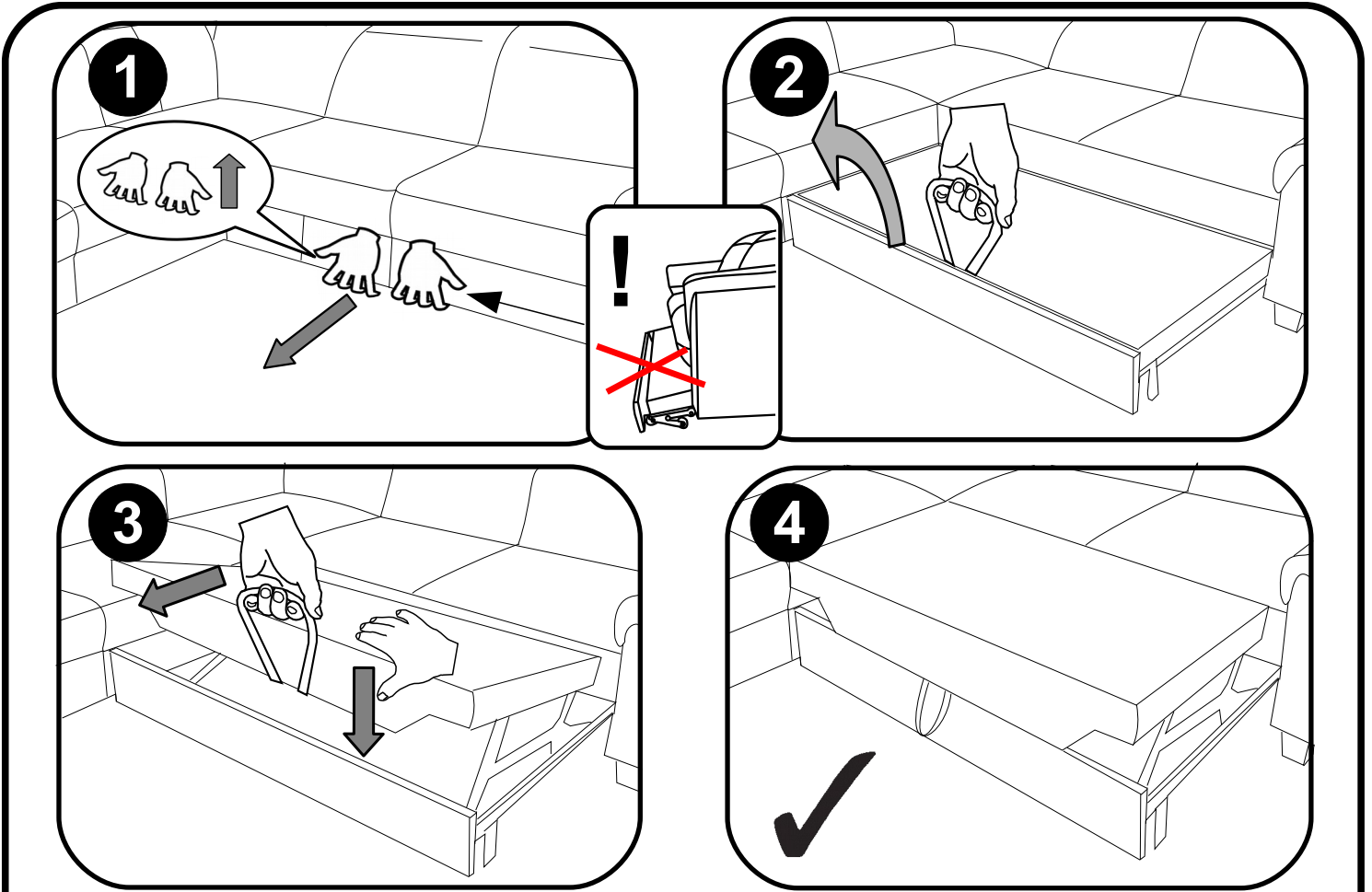
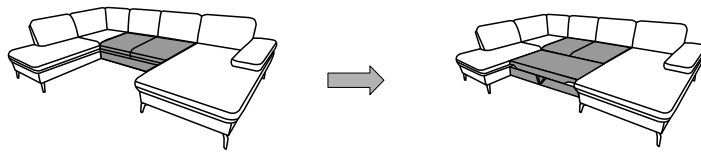





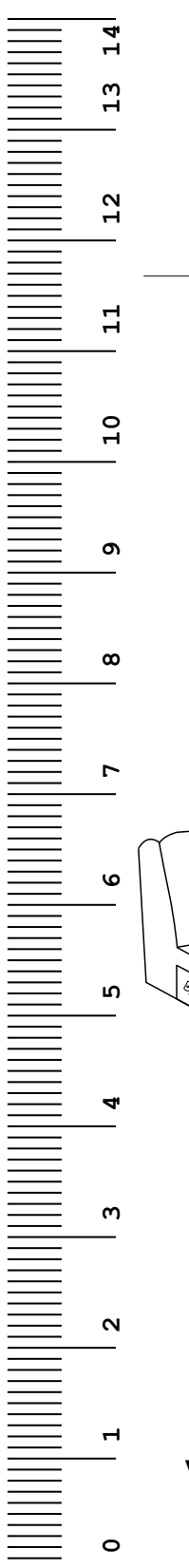
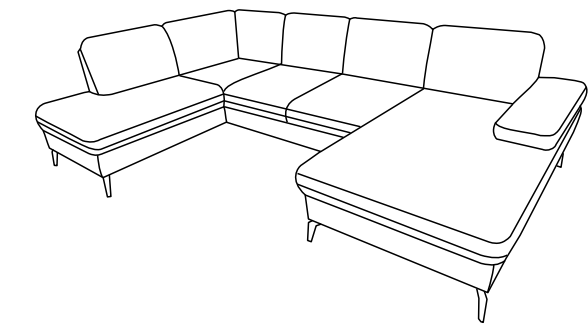
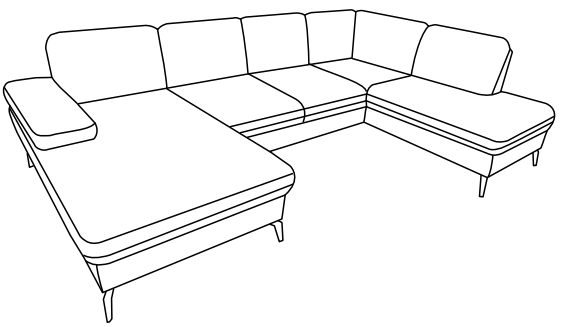
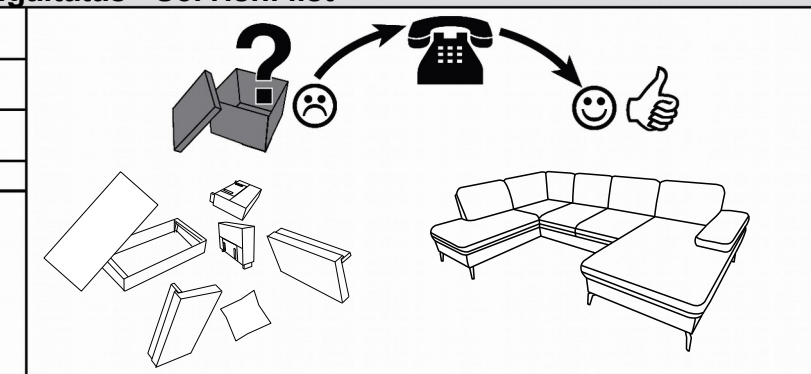
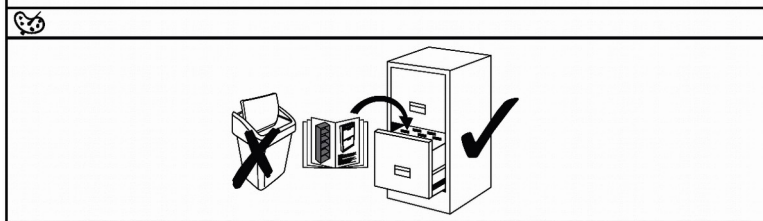

Service · Dienstverlening · Serwis · Servis · Сервисная служба · Servis · Services · Servizio
 · Servisný list · Szolgáltatás · Servisní list

Name · Naam · Nazwa · Ísim · Название · Nume · Nome · Názov · Názov ·
 Název · Neve

MORRIS

Typ · Type · Tip · Тип · Tipo · Típus



g H-120/150 	v H-120/150 	S H-120/150  s ₁ 	q M6*25 [mm] 
--	--	---	--

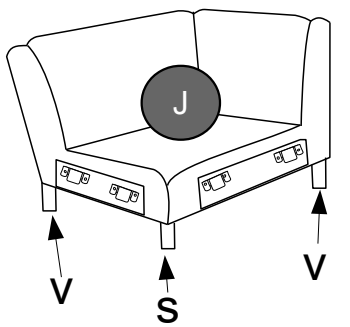
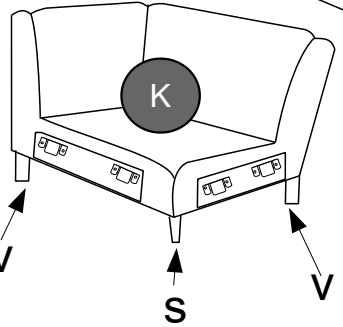
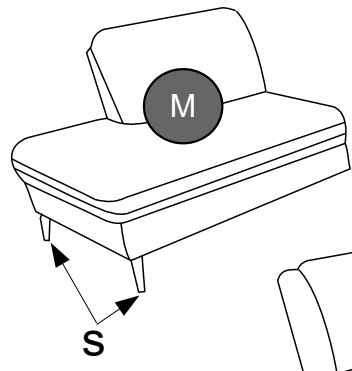
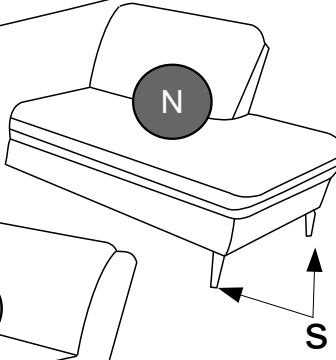
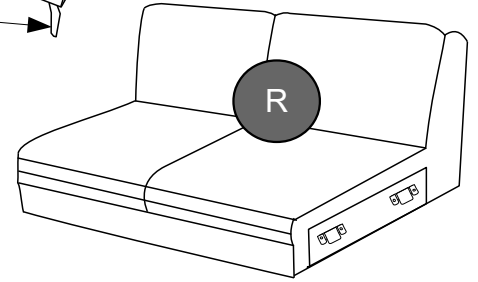
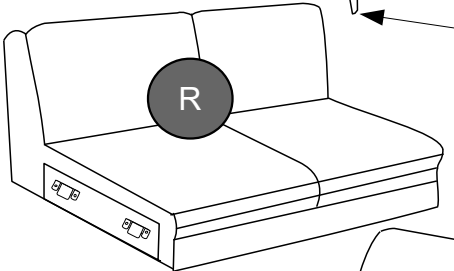
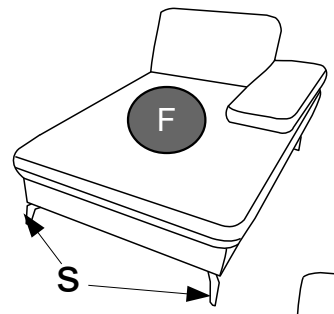
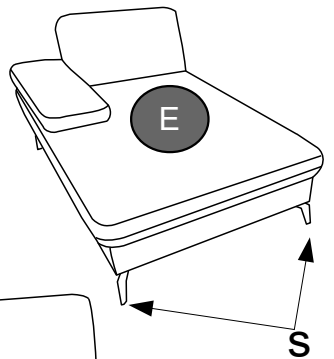

10