

Art. Nr. 545338; 798992; 59147010

LKZ 40605

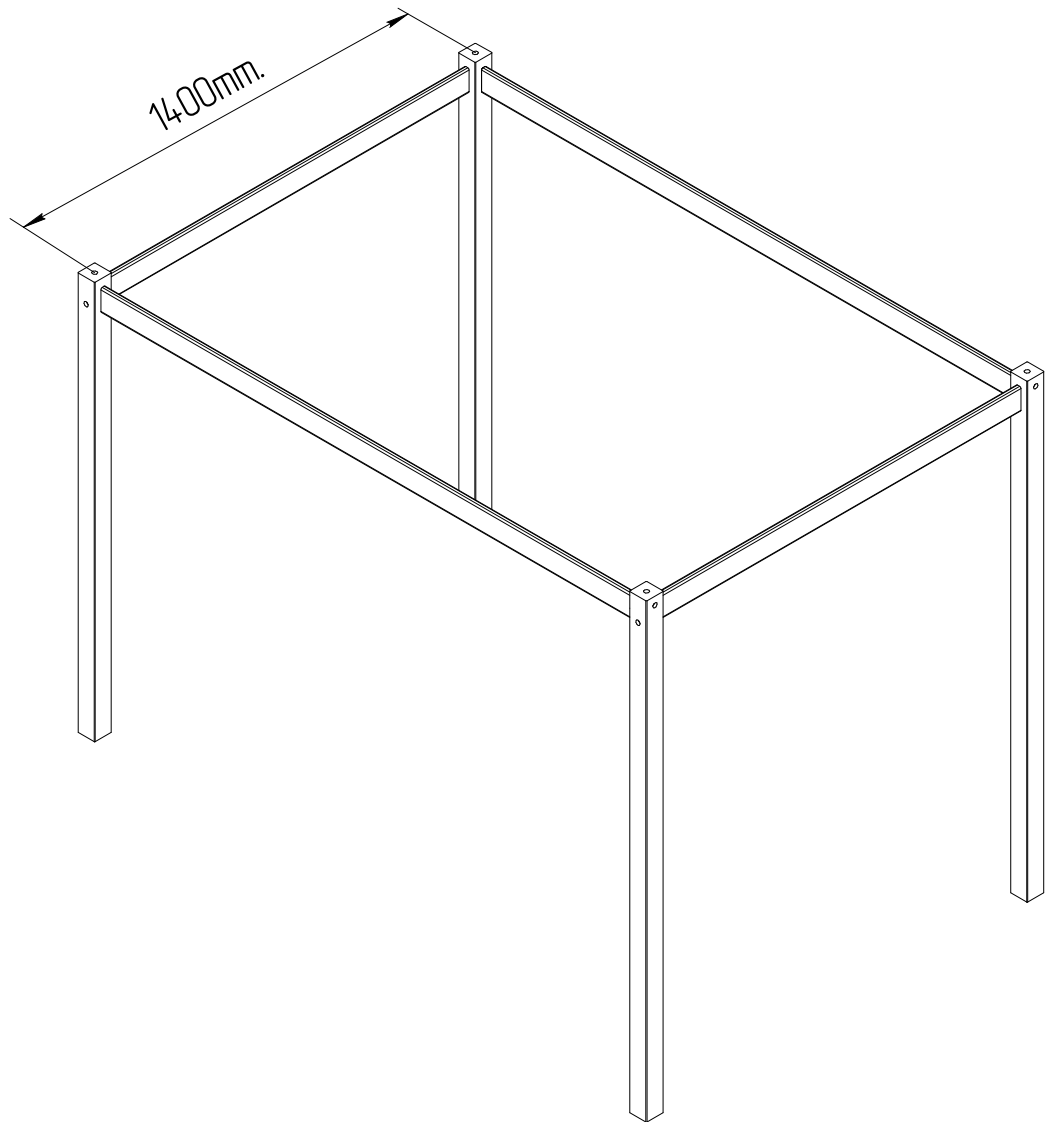

- | | | | |
|-----------|------------------------------------|-----------|--------------------------------|
| D | Montageanleitung | GB | Assembly instructions |
| FR | Notice de montage | IT | Istruzioni di montaggio |
| NL | Handleiding voor de montage | PL | Instrukcja montażu |
| CZ | Montážní návod | SK | Návod na montáž |
| HU | Szerelési útmutató | RO | Instrukțiuni de montaj |
| TR | Montaj talimatı | RU | Инструкция по монтажу |

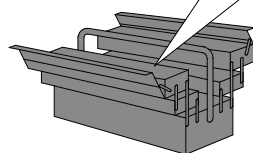
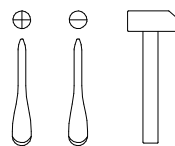
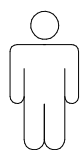



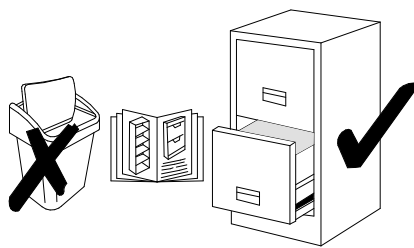
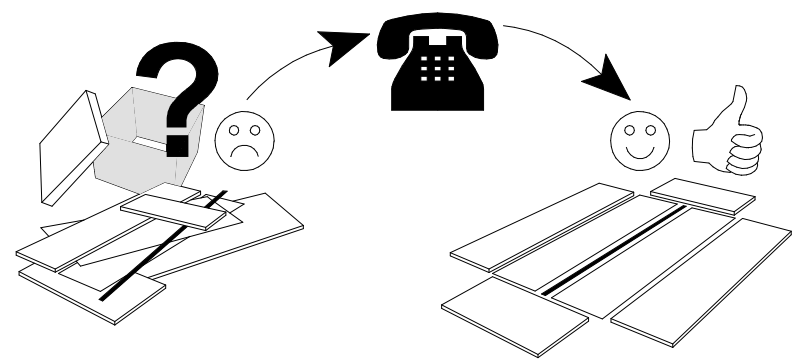

Service · Dienstverlening · Serwis · Servis · Сервисная служба

Name · Naam · Nazwa · Isim · Название
Nr. · No. · Номер
Typ · Type · Tip · Тип

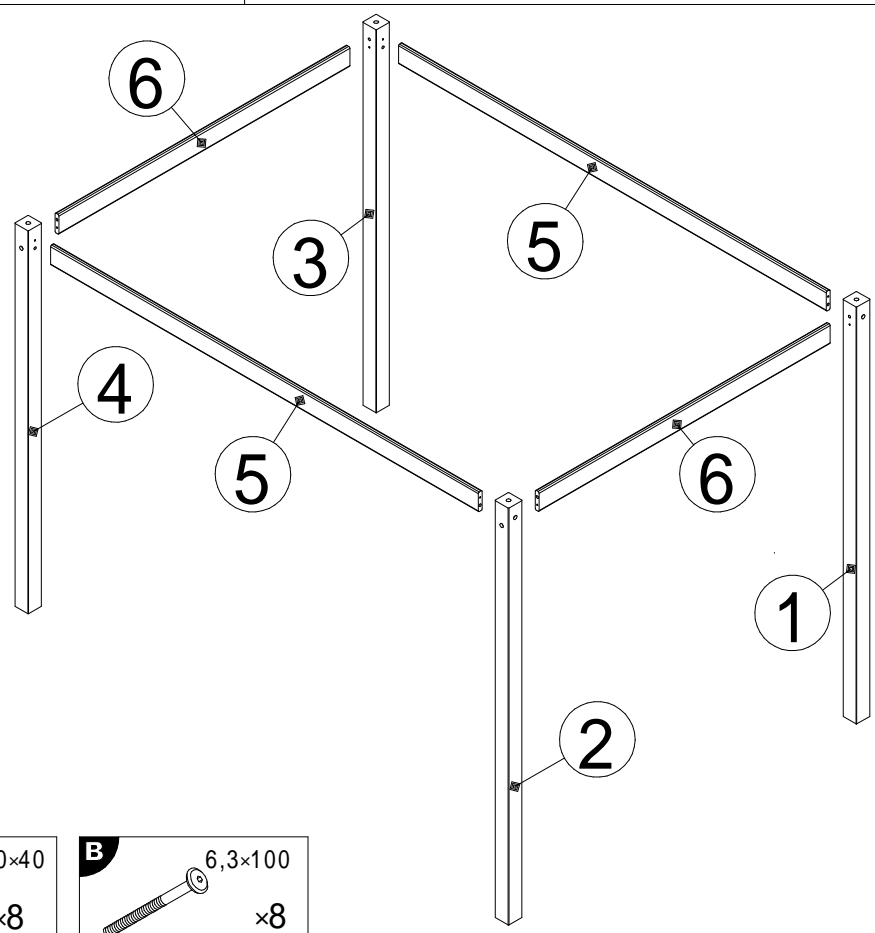

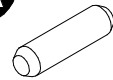
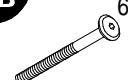

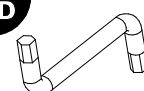
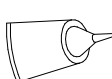
0
10
20
30
40
50
60
70
80
90
100
110
120
130
140
150
160
170
180
190
200

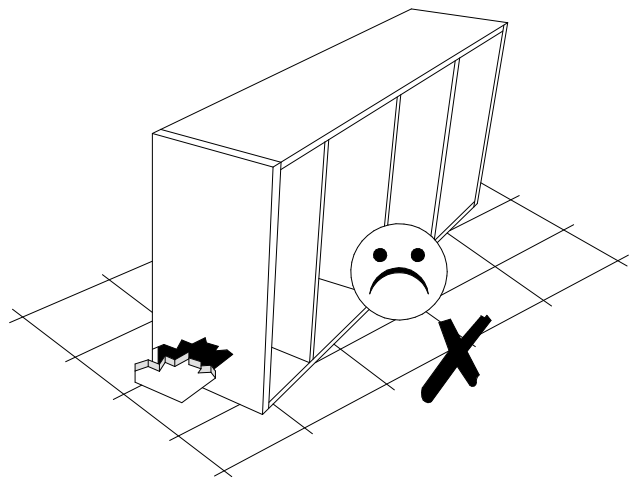
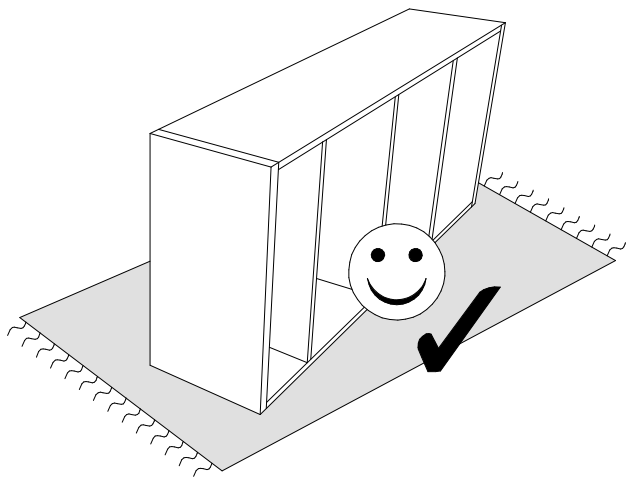

- | | |
|--|--|
| A

10×40
×8 | B

6,3×100
×8 |
| C

×8 | D

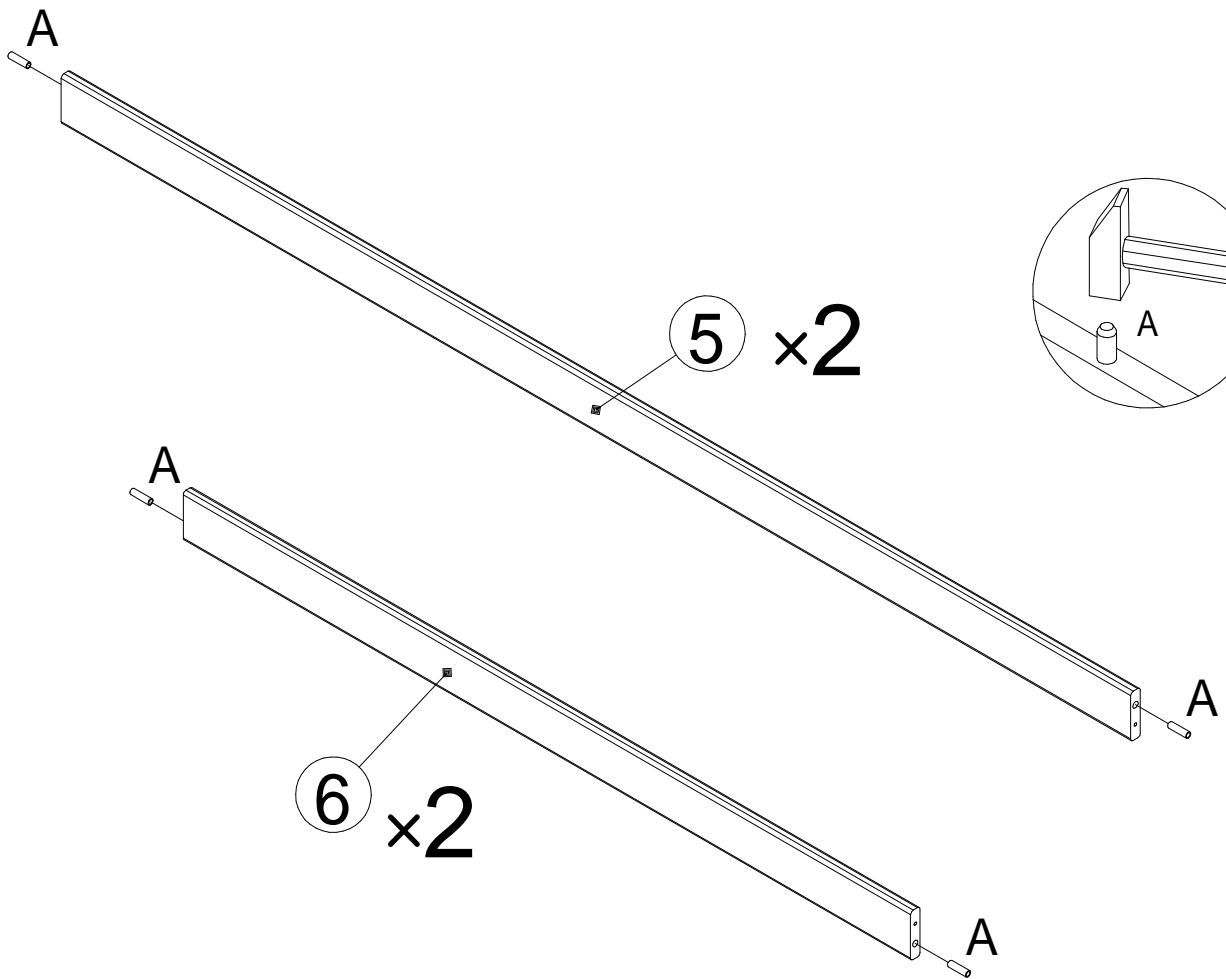
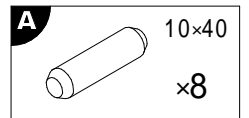
SW 4
×1 |
| E

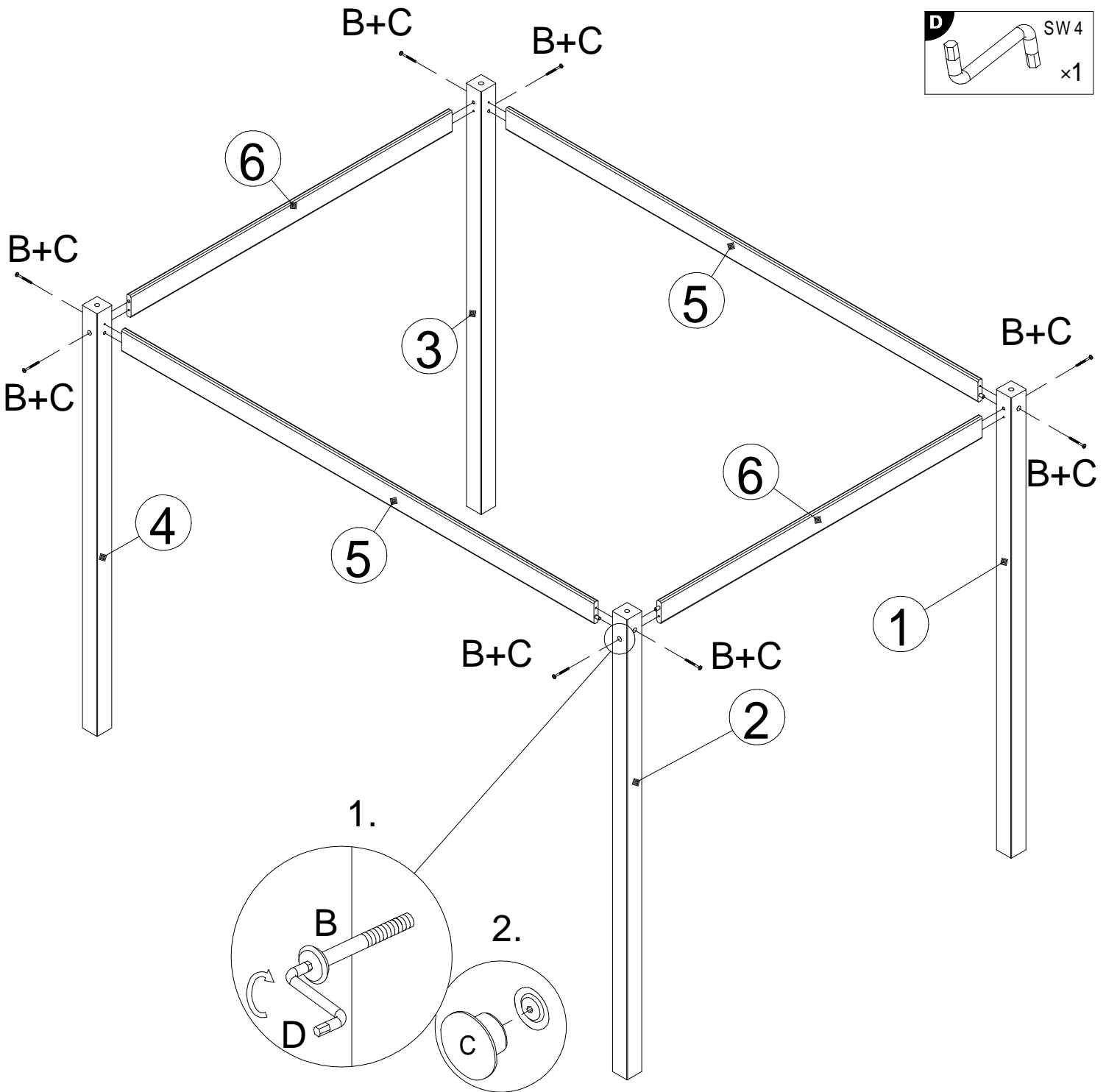
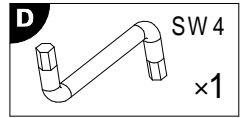
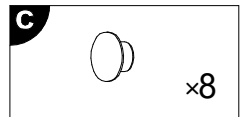
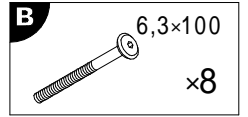
×1 | G

16×86
×4 |
| Z 87

×1 | |

N	Size/MaB (mm)	Qty	✓
1	1690×60	1	
2	1690×60	1	
3	1490×60	1	
4	1490×60	1	
5	2000×70	2	
6	1360×70	2	



1





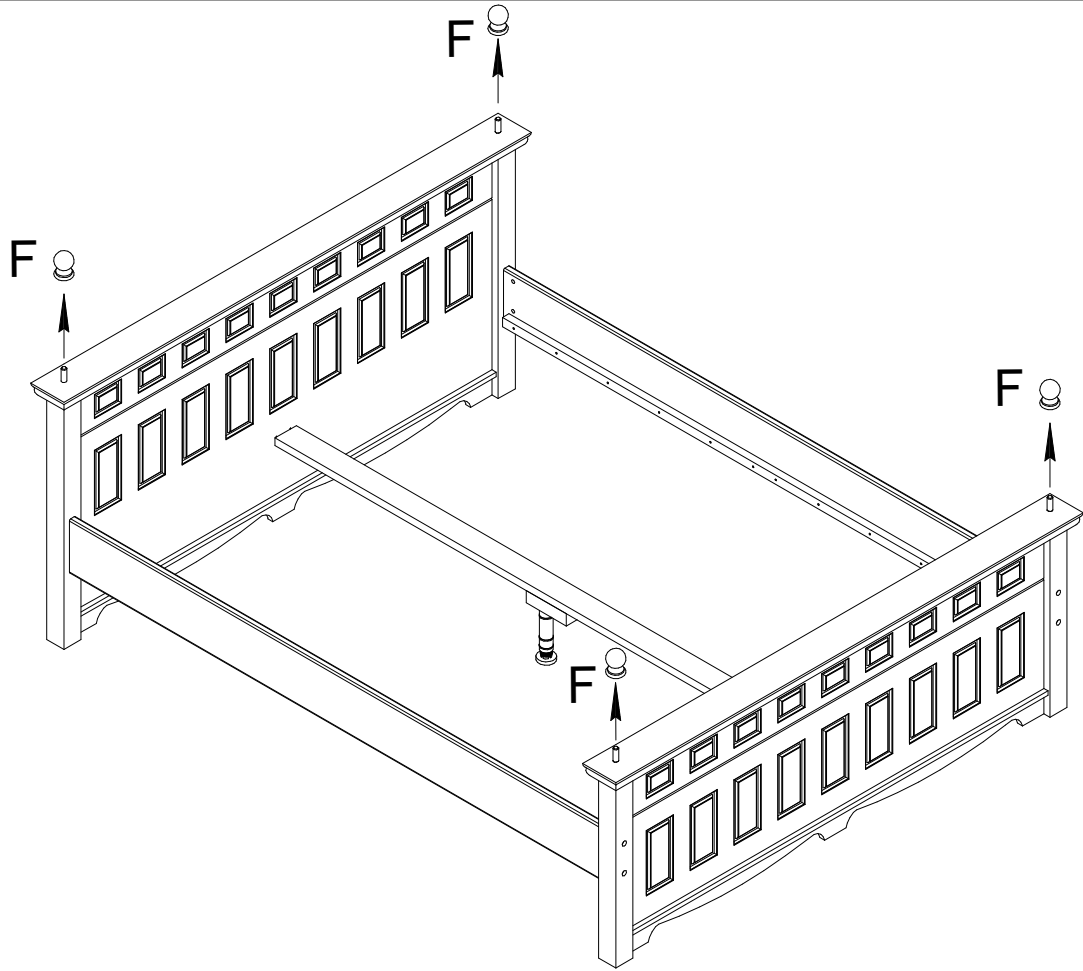

3

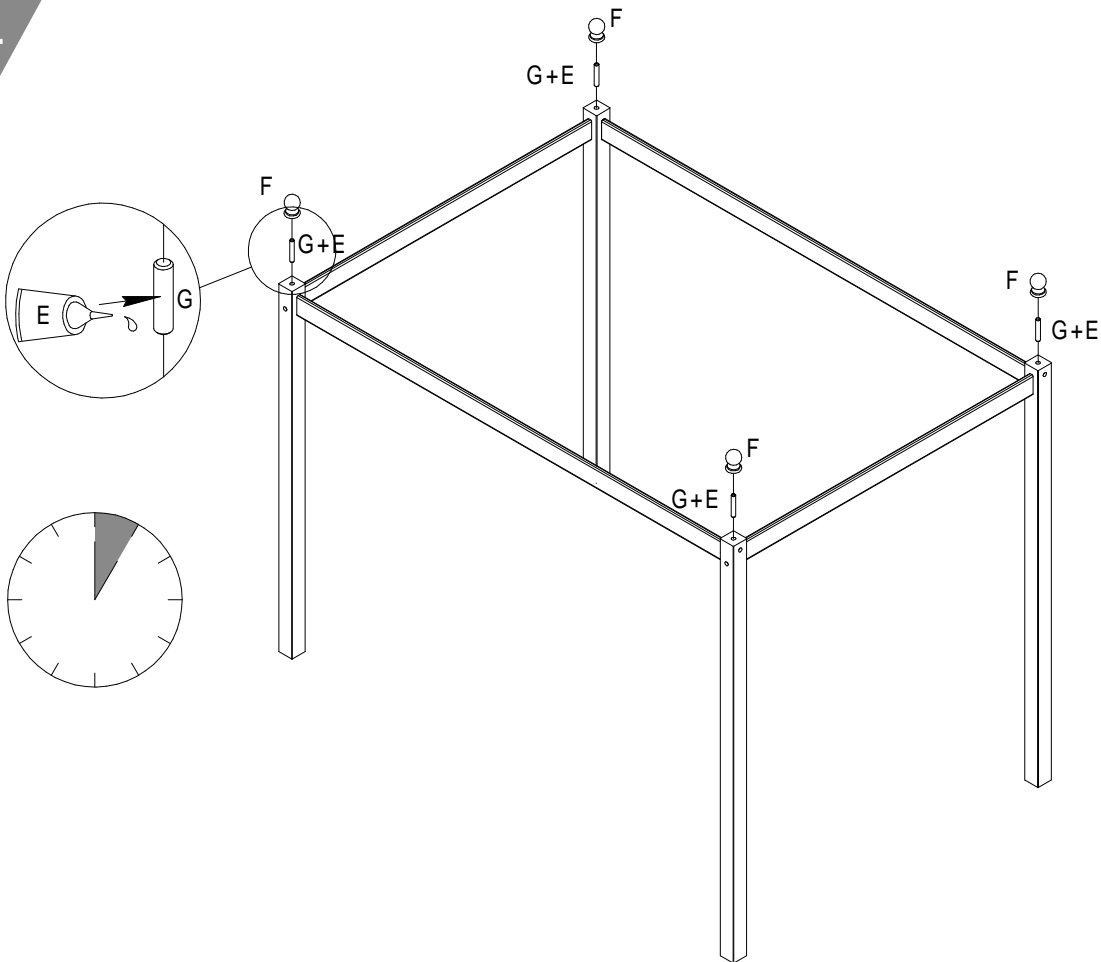

4

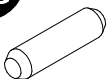

E			x1
D	Leim	CZ	Lepidlo
GB	Glue	SK	Glej
FR	Colle	HU	Enyv
IT	Colla	RO	Adeziv
NL	Lijm	RU	Клей
PL	Klej	TR	Tutkal

G		16x86
		x4

5

G 16x86
x4

Z 87
Home x1

