

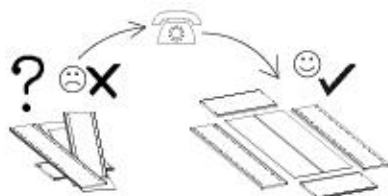

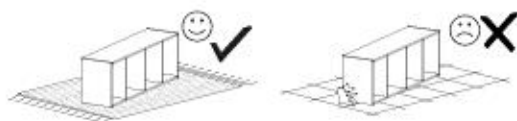

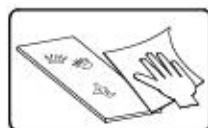
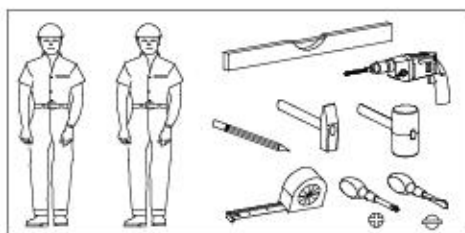
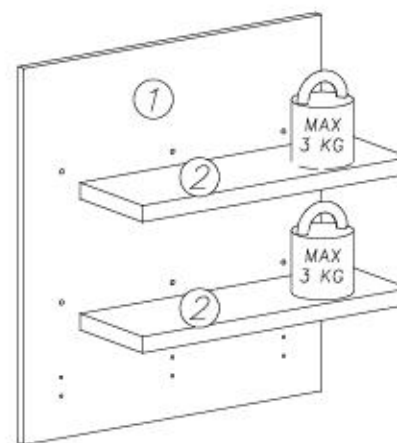
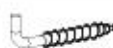

- ⓓ Montageanleitung
- ⓃⓁ Handleiding voor de montage
- ⓉⓇ Montaj talimatı
- ⓕ Notice de montage
- ⒸⓏ Montážní návod
- ⓗⓤ Szereelési útmutató
- ⓖⓔ Assembly Instructions
- Ⓟ Instrukcja montażu
- Ⓡⓤ Инструкция по монтажу
- ⓇⓉ Istruzioni di montaggio
- ⓈⓀ Návod na montáž
- Ⓡⓞ Instrucțiuni de montaj
- ⓔⓈ Instrucciones de montaje
- ⓉⓇ Montaj Talimatı

nr	L[mm]	B[mm]	T[mm]	Merçe	Call.
1	644	600	16	1	1/1
2	538	180	28	2	1/1

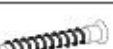

U7  x2	U8  ø10x60 x2	W2  x1	A1  ø7x50 x6	N23  M4x20 x6	Q8  x3	G46  6x8 x4	U1  x2
---	---	---	--	---	---	---	---

3/5

Küche WESTMINSTER D4



I

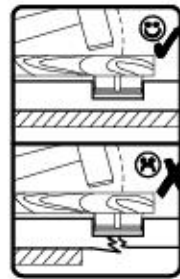
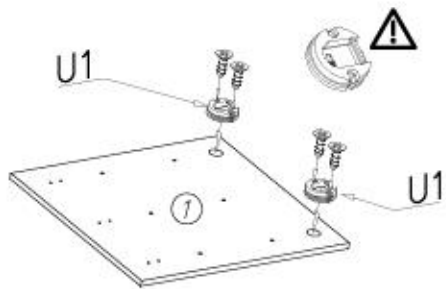

G46



6x8

x4

U1



x2

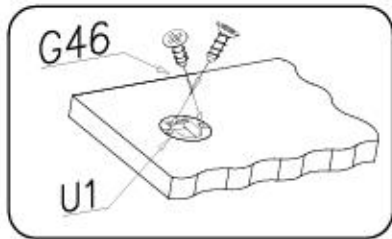

II

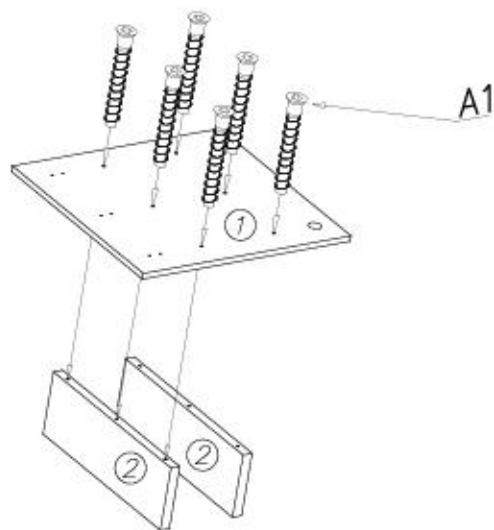

A1

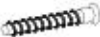

Ø7x50

x6

W2



x1

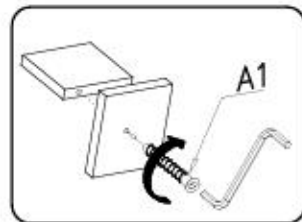

4/5

Küche WESTMINSTER D4



III

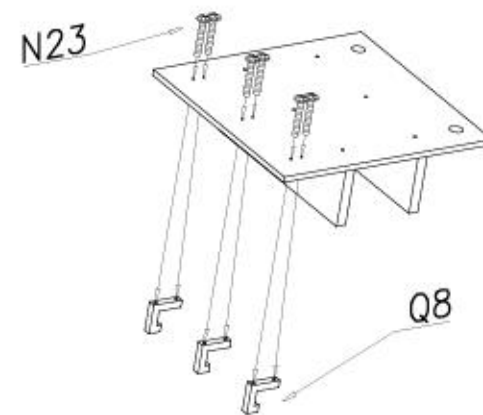

N23



M4x20

x6

Q8



x3

IV

U8



Ø10x50

2x

U7S



2x

1

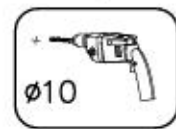

2



3

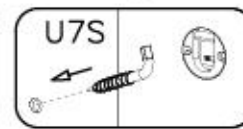

4

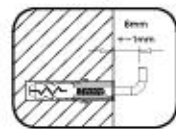

5

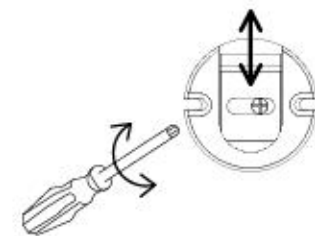
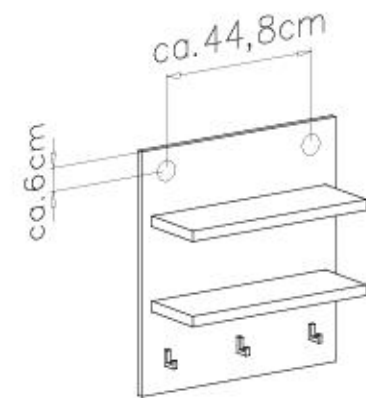
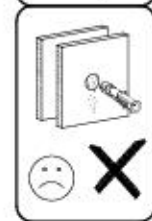
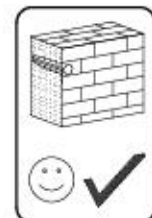
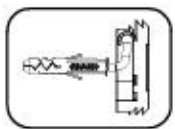

Name • Nom • Nome • Naam • Nazwa • Иméно • Νόμος • Név • Denumire • Isim • Имяние	Nr • No • N° • Номер • Č • Sz	Typ • Type • Tip • Típus • Tipo • Тип
Küche WESTMINSTER	--	D4

D Unser Dienstleistungen für Beschädigte
 Sollte Ihnen ein Beschädigt fallen, können Sie diese Serviceleistungen direkt an die zuständige Nummer senden. Wir können allerdings nur Beschädigte auf diesem Weg verschicken. Bitte Sie eine andere Schadensmeldung an Ihrem Möbelhaus haben, so werden Sie sich besser direkt an Ihr Möbelhaus.

GB Our direct order service for fitting
 If a fitting should be missing to you, you know this service map directly following number boxes. We can in this way send away however only fitting. If you should have another objection to your piece of furniture, then they turn please to your furniture house.

CZ Nežte přímé služby pro školení
 Pokud Vám nějaký díl chybí, můžete tuto službu také odvolat přímo na číslo uvedeného čísla. Vždy prosíme, abyste případně škodu oznámili přímo v obchodě. Pokud byste reklamovali číselní číslo, obrátíte se přímo na svého prodejce nábytku.

F Bien étudier le notice de montage
 Étudier les pièces constitutives votre meuble. Regrouper et contrôler la quincaillerie. Vérifier - vous de l'outillage nécessaire. Amener à une zone de montage. Procéder au montage. Ne jamais forcer les assemblages. Réviser les vis après quelques temps d'usage. Garder votre notice de montage, si une pièce venait à manquer, elle serait le plus sûr moyen de communiquer avec votre magasin.

I Il nostro servizio diretto per l'ordine della ferramenta
 Nel caso di mancanza di un pezzo, potete spedire per questo canale che servizio direttamente al seguente numero. Per altri problemi al vostro mobile, potete rivolgervi al vostro mobilificio.

BG Изпълнение директно за повреди
 Ако някъде липне от комплект, можете директно да ни пишите и да ни дадете номера на повредените части. Моля да ни дадете номер на повредените части. Моля да ни дадете номер на повредените части. Моля да ни дадете номер на повредените части.

NL Directe dienstverlening voor losse onderdelen
 Wanneer er een onderdeel mist kunt u deze servicekaart direct aan de betreffende nummer sturen. Wij kunnen alleen langs deze weg onderdelen verschuren. Houdt u een ander probleem aan uw meubel hebben verduidelijk wij u contact op de manier met uw meubelzaak.

PL Usługi bezpośrednie serwis części meblowych
 Jeżeli brakuje części koniecznych do montażu, prosimy o przesłanie nam tej karty serwisowej na niniejszy numer faxu. Pamiętajmy w ten sposób przesłać potrzebny tylko brakuje części. W przypadku innych obaw dotyczących mebla, prosimy o skierowanie ich do naszego meblowego w którym został dokonany zakup.

HR Servis za stolice
 U slučaju da nedostaje neki od dijelova molimo vas da ne dajete narediti. Bez tog poselje ovaj servis obraditi. Na ovaj način mogu se dostaviti samo stolice. U slučaju da imate dodatne prigovore vezane sa stolice molimo vas da se obratite izravno trgovini namještaja gdje je i kupili.

HU Közvetlen szolgáltatás részletek csobán
 Ha néhány alkatrész hiányzik, akkor a felsorolt telefonszámra az alábbi telefonszámra küldhetjük a részleteket. Azonban csak a felsorolt alkatrészek küldhetők. Amennyiben másféle problémák állnak fenn a vásárolt tárgyakkal kapcsolatban, forduljon közvetlenül a boltiáruházhoz.

SK Máe priamo servis pro školení
 Ak by Vám chýbalo nejaké dielce, môžete poslať túto službu priamo poslať faxom priamo na číslo uvedené formou c. st. Dajú formu alebo poslať faxom priamo na číslo uvedené. Ak by ste mali iné otázky, obrátte sa priamo na váš predajcu nábytku.

SLO Nežte přímé služby školení za stolice
 Če vam manjka kakšno delce, lahko to službo lahko pošljete po faxu direktno na spodnje število. Po tej poti vam lahko pošljemo samo stolice. Če imate kakšne druge vprašanje, se obrnite neposredno na vašo trgovino pohištva.

RO Servis-ul nostru direct pentru formante
 In cazul in care va lipseste o piesa de formanta puteti sa trimiti direct acest card de service pe fax la numarul de mai jos. Noi nu putem expedii piesa de formante direct pe acest canal. Dacă aveți o altă reclamație referitoare la piesa de mobilier, atunci vă rugăm să vă adresați direct la magazinul dvs. de mobilă.

RUS Наш прямой сервис для поставки недостающих деталей мебели
 Если Вам не хватает какой-либо детали мебели, Вы можете отправить заявку на доставку недостающих деталей по номеру, указанному ниже. Однако, только детали мебели можно доставить по этому телефону. Если у Вас возникли иные претензии относительно приобретенной мебели, пожалуйста, обращайтесь непосредственно в магазин, осуществляющий продажу.







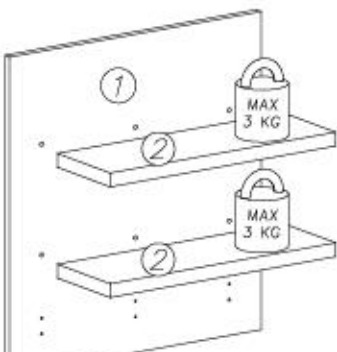

S Vår direkte service for beslagdelar
 Om du saknar en beslagdel kan du faxa detta servicekort direkt till nummer som anges nedan. Fax kan dock inte skicka skadegörningar och andra beslagdelar till dig. Om du vill reklamera din möbel av en annan anledning måste du kontakta ditt möbelhus direkt.

ES Nuestro servicio directo para accesorios
 Si le falta algún accesorio, puede enviar esta tarjeta de servicio directamente a la siguiente dirección. No obstante, por este método solo podemos enviar accesorios. Si tiene alguna otra objeción sobre su mueble, consulte directamente con su mueblería.

TR Doğrudan hizmetler için
 Bir mobilya parçası ya da servisi parçanın doğrudan teslimatını isterseniz, aşağıdaki numaraya yazarak talebinizi iletebilirsiniz. Mobilya ile ilgili diğer sorunlarınızı veya diğer doğrudan mobilya aksesuarları için.

nr	L[mm]	B[mm]	T[mm]	Menge	Coll
1	644	600	16	1	1/1
2	538	180	28	2	1/1

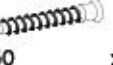

Q8 	U1 	G46 
x...	x...	6x8 x...
U7 	U8 	W2 
x...	#10x60 x...	x...
A1 	W1 	N23 
#7x50 x...	x...	M4x20 x...

