

# Trumpet

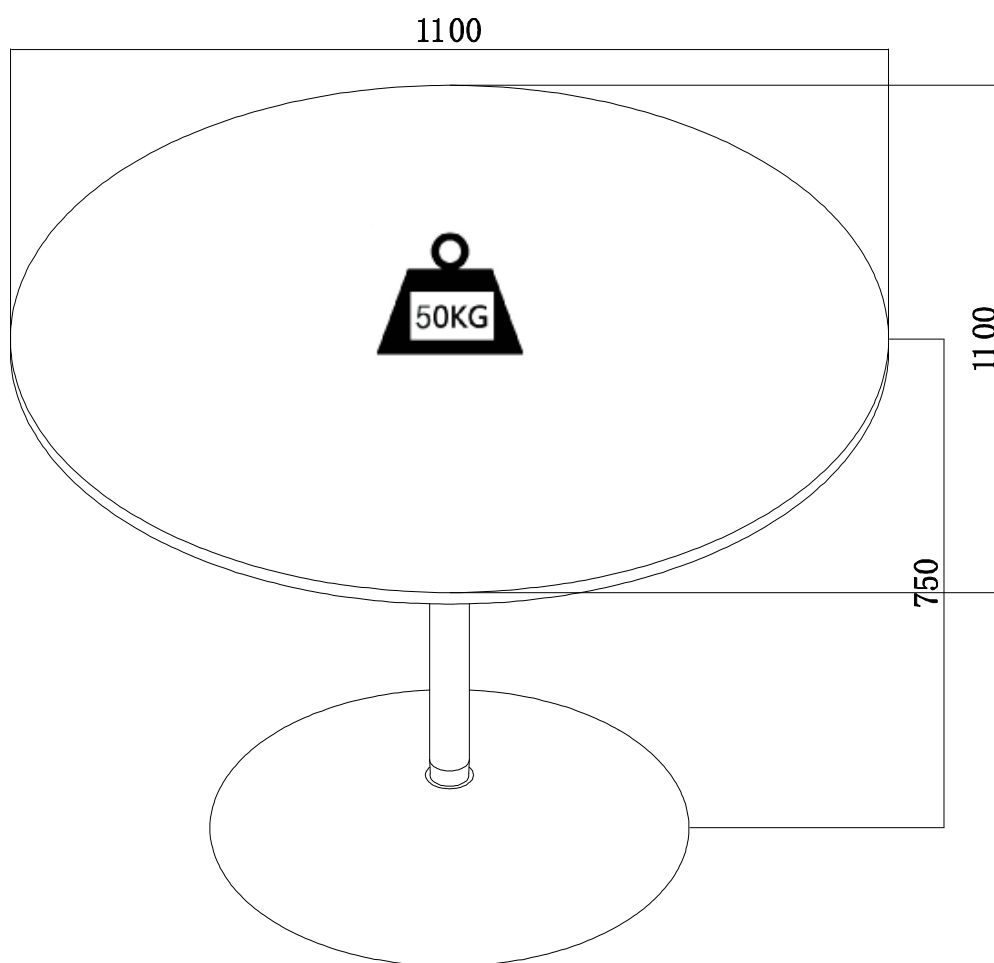

- (D) Montageanleitung
- (FR) Notice de montage
- (NL) Handleiding voor de montage
- (CZ) Montážní návod
- (HU) Szerelési útmutató
- (TR) Montaj talimatı

- (GB) Assembly instructions
- (IT) Istruzioni di montaggio
- (PL) Instrukcja montażu
- (SK) Návod na montáž
- (RO) Instrucțiuni de montaj
- (RU) ИНСТРУКЦИЯ ПО МОНТАЖУ

**Service • Assistenza • Dienstverlening • Serwis  
Servis • Szerviz • Сервисная служба**

Name • Nom • Nome • Naam •  
Nazwa • Jméno • Názov • Név •  
Denimire • İsim • Название

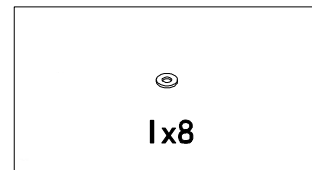
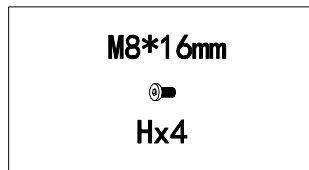
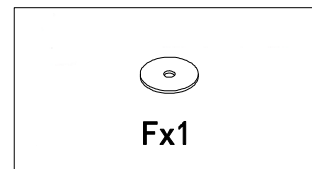
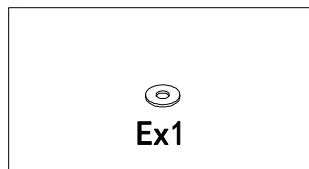
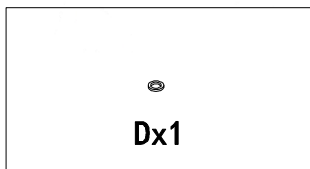
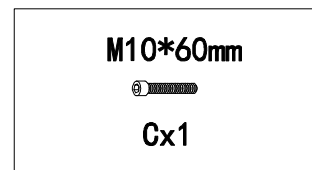
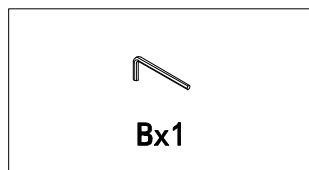
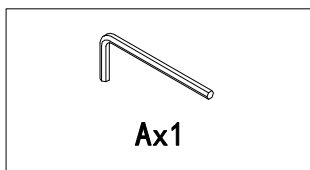
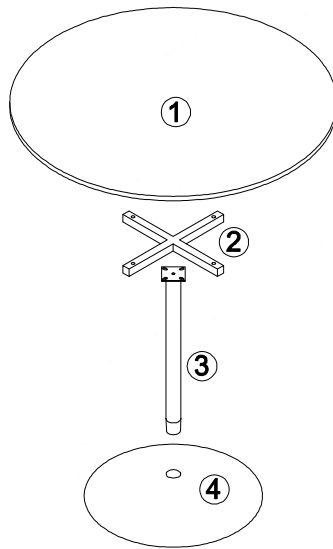
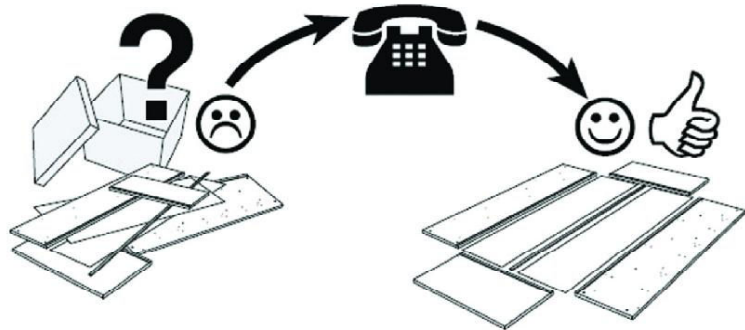
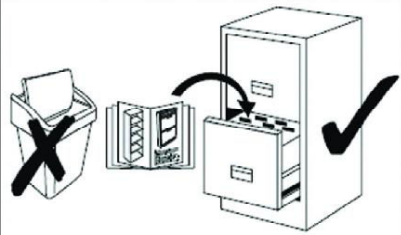

Nr. • No. • N° • Номер • Č • Sz

Tур • Туре • Tip • Típus • Típo •  
Тип



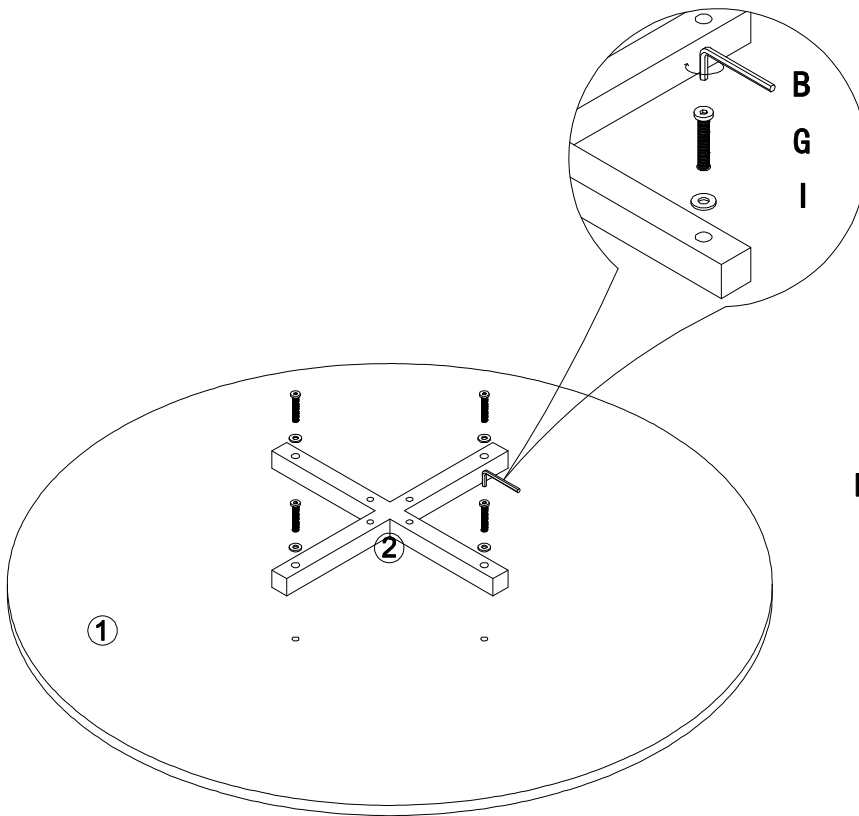



1

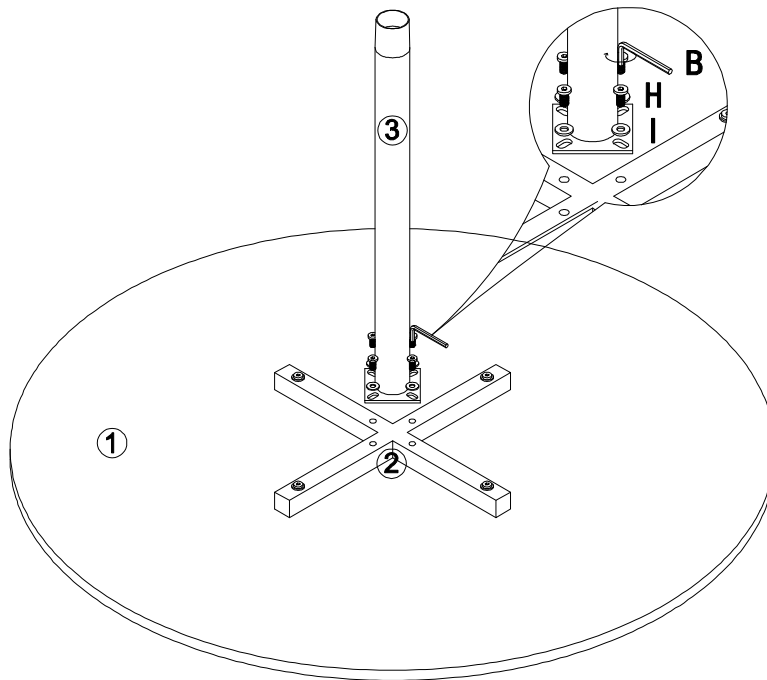

-  Bx1
-  Gx4  
M8\*45mm
-  Ix8

2



-  Bx1
-  Hx4  
M8\*16mm
-  Ix8

3

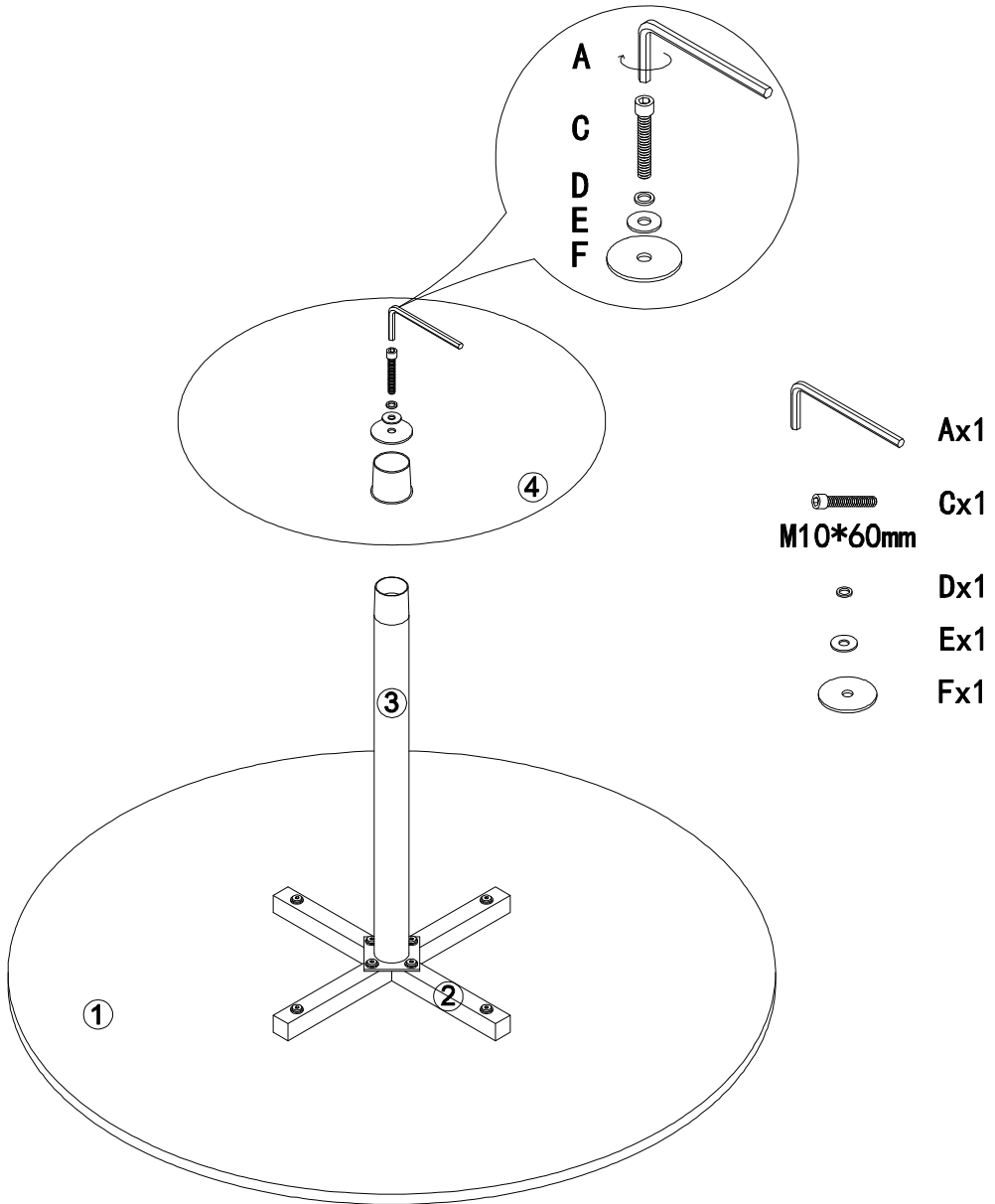

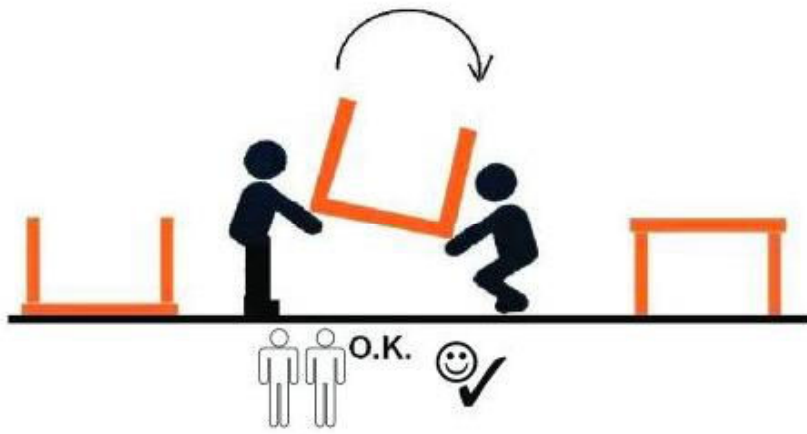
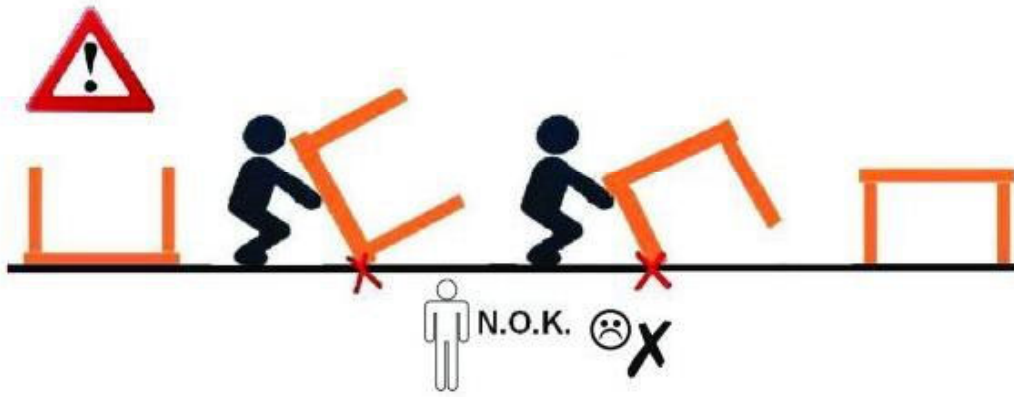



- |   |                                     |
|---|-------------------------------------|
| <b>(D)</b> Montageanleitung             | <b>(GB)</b> Assembly instructions   |
| <b>(FR)</b> Notice de montage           | <b>(IT)</b> Istruzioni di montaggio |
| <b>(NL)</b> Handleiding voor de montage | <b>(PL)</b> Instrukcja montażu      |
| <b>(CZ)</b> Montážní návod              | <b>(SK)</b> Návod na montáž         |
| <b>(HU)</b> Szerelési útmutató          | <b>(RO)</b> Instrucțiuni de montaj  |
| <b>(TR)</b> Montaj talimatı             | <b>(RU)</b> Инструкция по монтажу   |

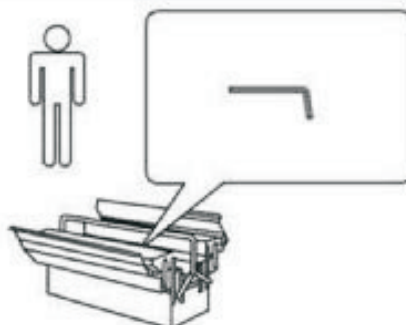

**Service • Dienstverlening • Serwis • Servis • Сервисная служба**

Name • Naam • Nazwa • İsim • Назва-иѐ	
Nr. • No. • Номер	
Typ • Type • Тип • Тип	

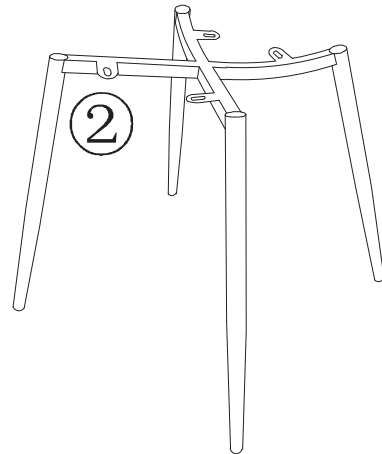
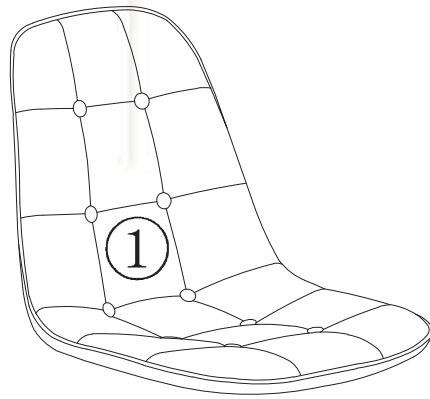

①	x1
②	x1

<b>A</b> x1	<b>B</b> x4	<b>C</b> x4	<b>D</b> x4
-------------	-------------	-------------	-------------

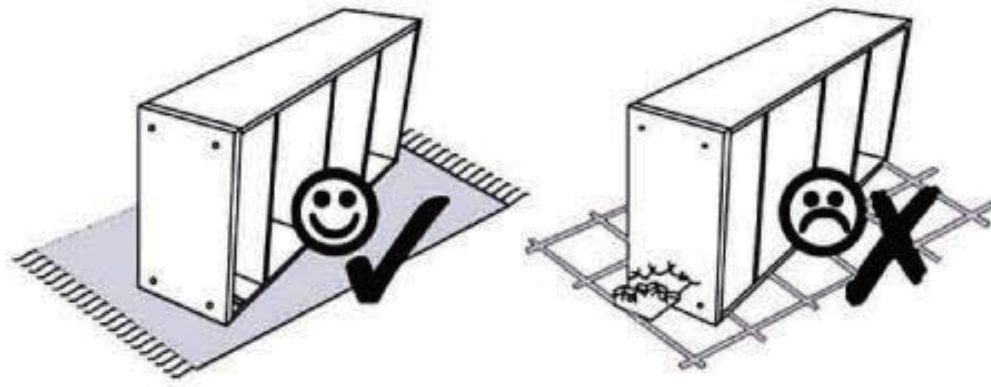

1

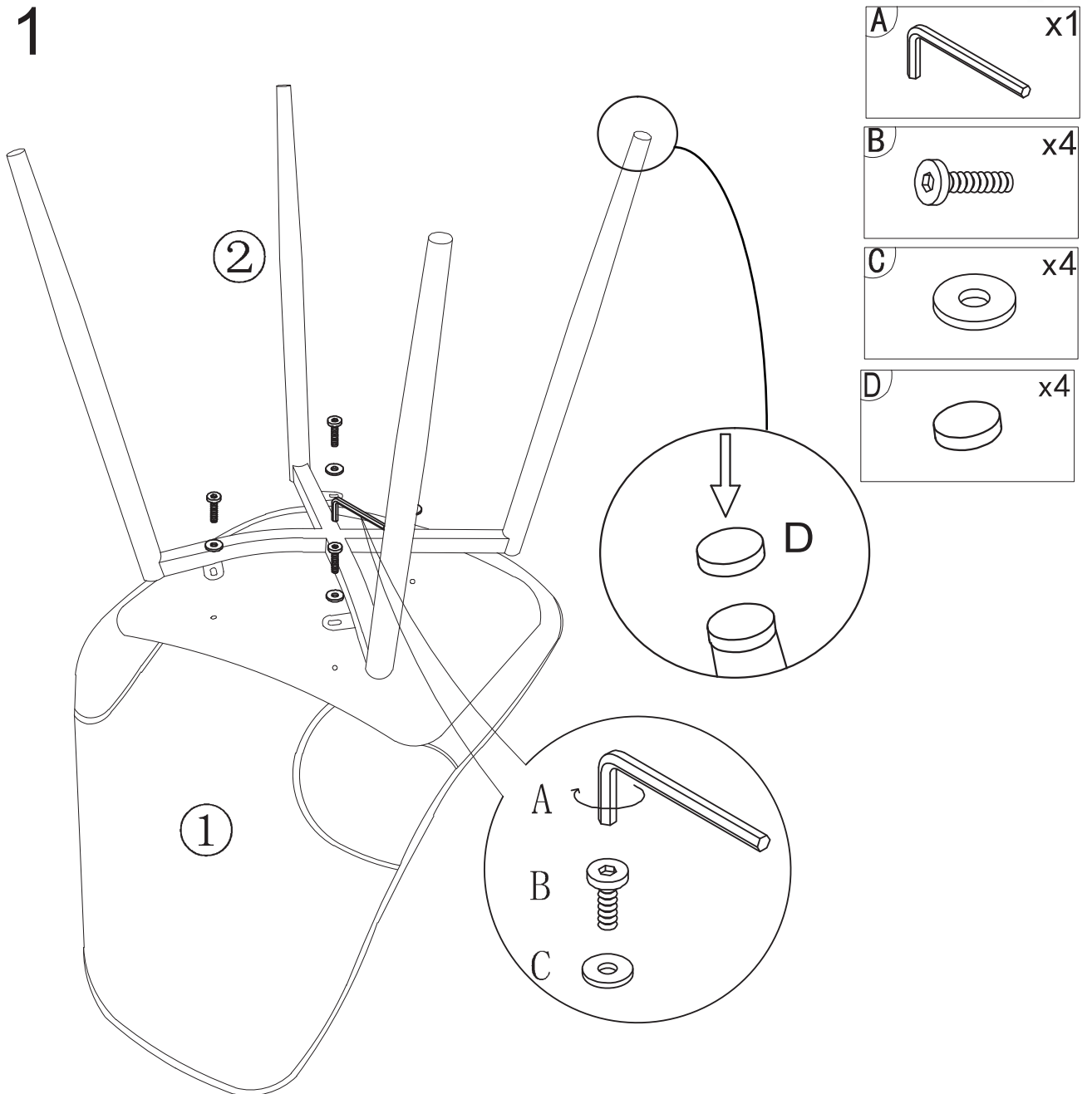



---

2



---

3