

RAVENNA 41

OPTION L

OPTION R

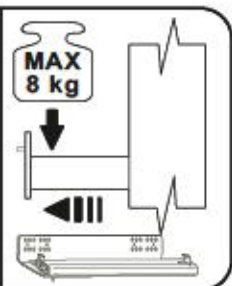
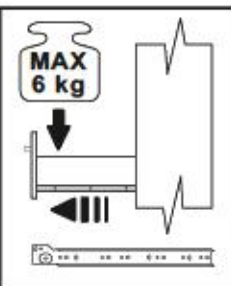
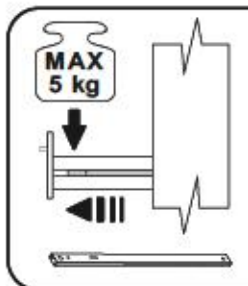
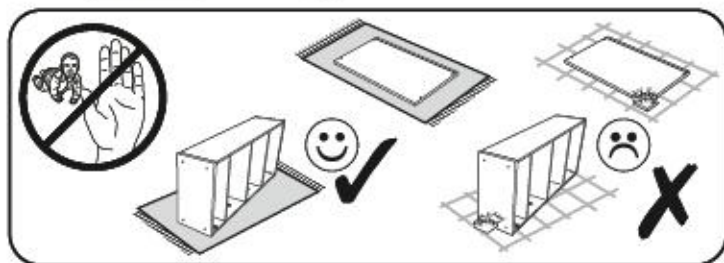
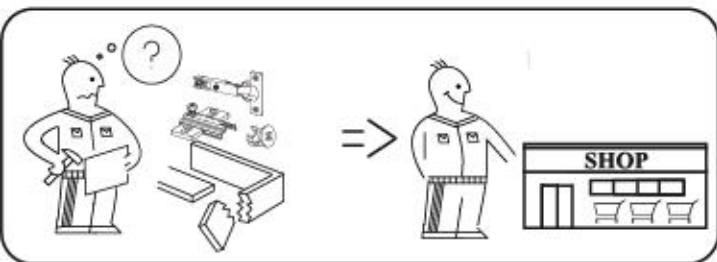
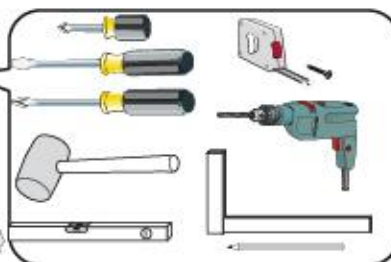
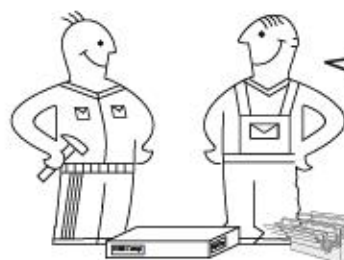
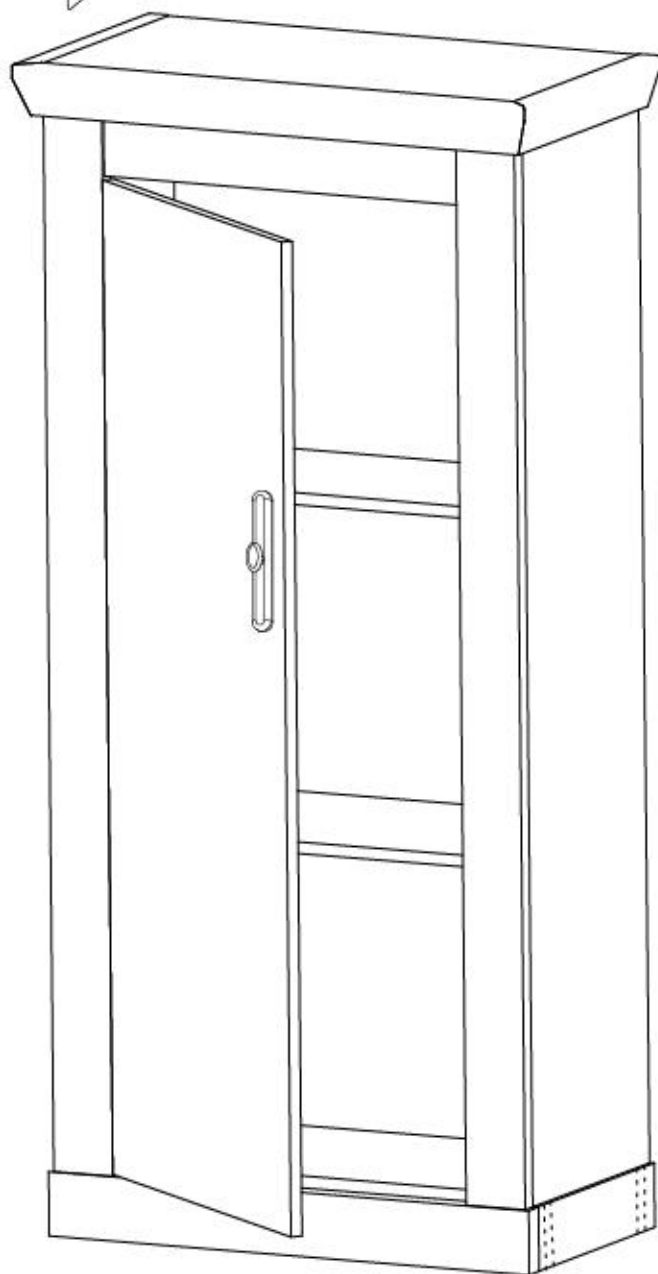
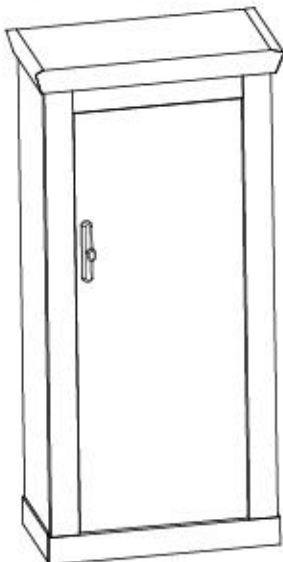
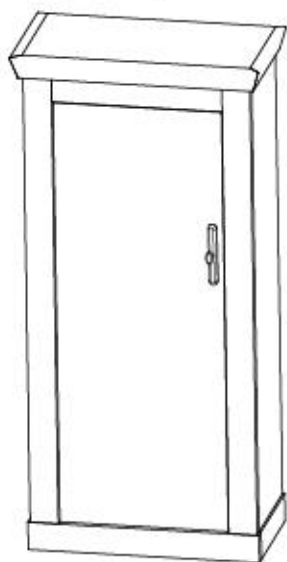

RAVENNA 41

max.



HC 62

HC 57

HC 101

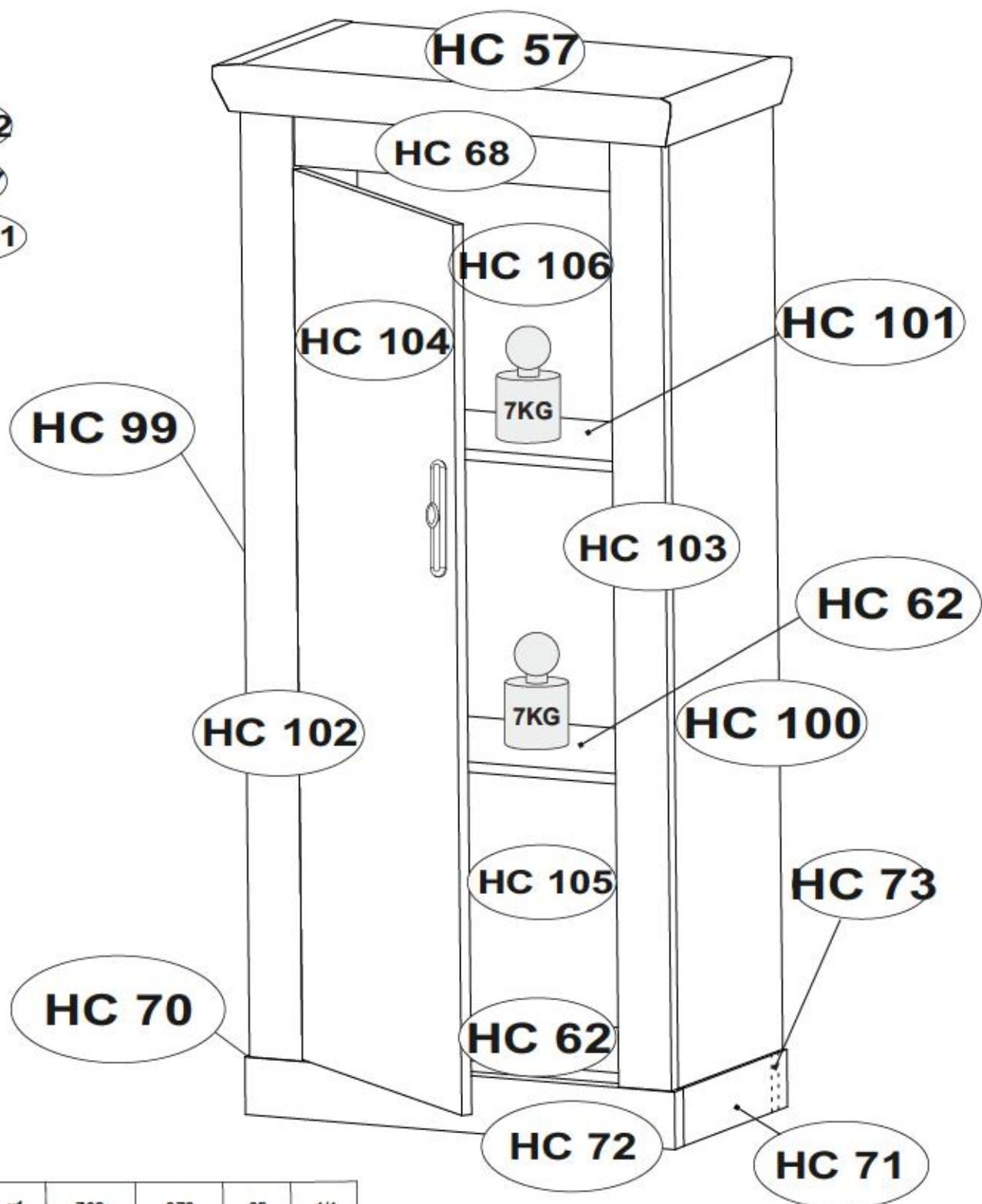



HC 57	x1	702	372	65	1/1
HC 62	x2	611	299	15	1/1
HC 68	x1	483	124	18	1/1
HC 70	x1	317	80	28	1/1
HC 71	x1	317	80	28	1/1
HC 72	x1	656	80	28	1/1
HC 73	x1	598	80	28	1/1
HC 99	x1	1361	320	15	1/1

HC 100	x1	1361	320	15	1/1
HC 101	x1	610	267	15	1/1
HC 102	x1	1361	80	22	1/1
HC 103	x1	1361	80	22	1/1
HC 104	x1	1231	477	15	1/1
HC 105	x1	421	623	2.5	1/1
HC 106	x1	945	623	2.5	1/1

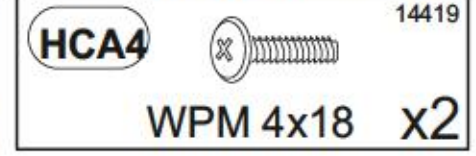
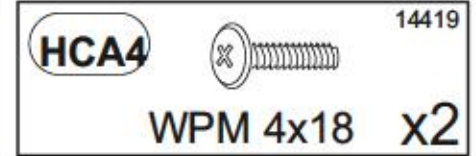
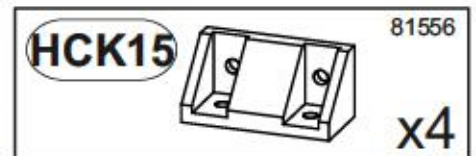
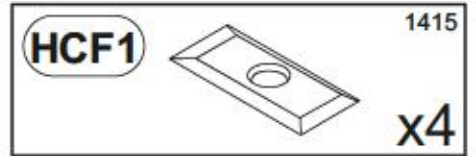
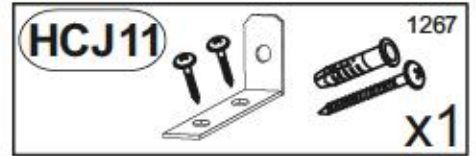
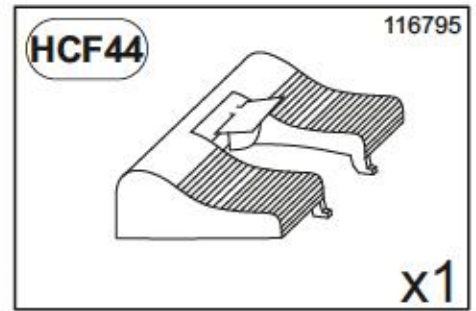
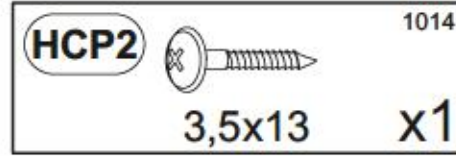
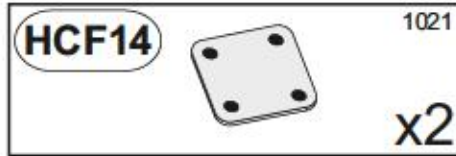
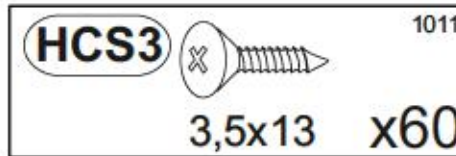
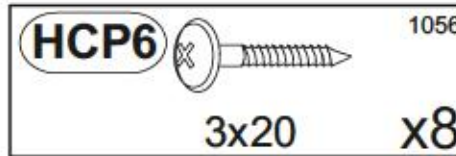
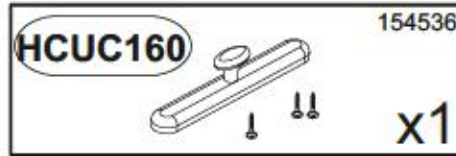
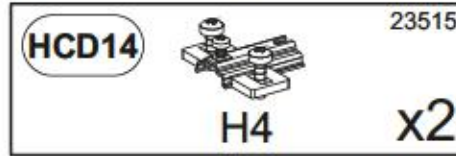
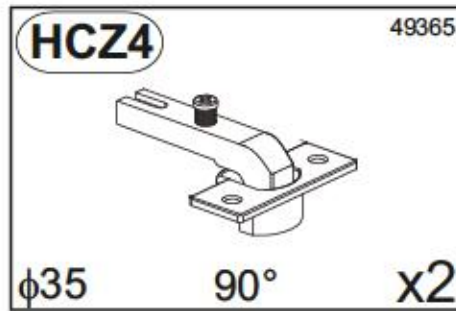
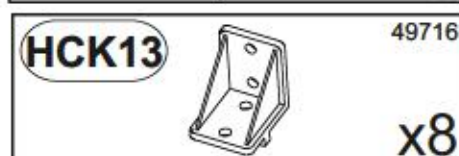
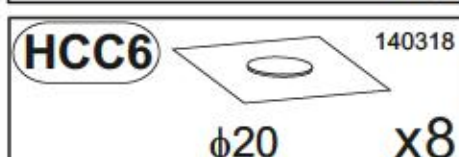
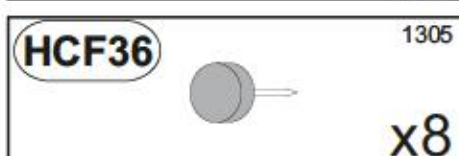
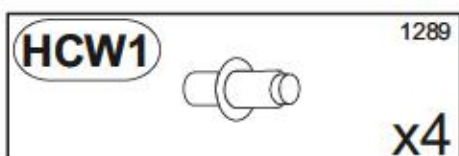
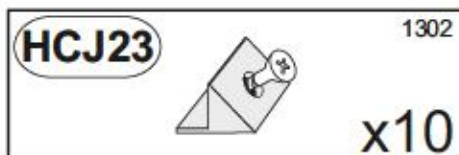
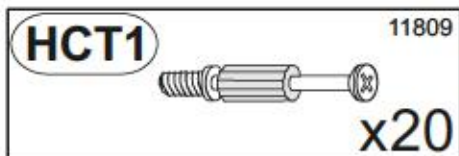
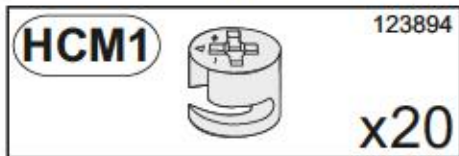
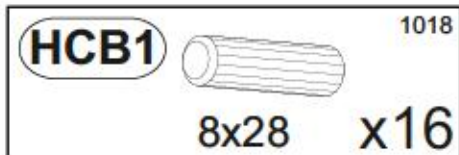
RAVENNA 41



1

HCM1		12 38 94	x4
HCK15		81 55 8	x2
HCS3		10 01	x4
		3,5x13	

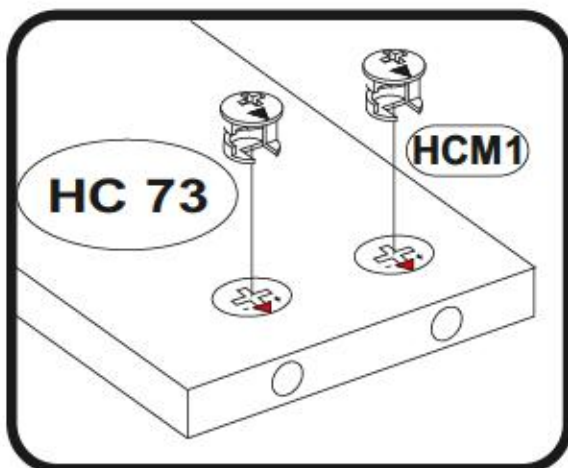
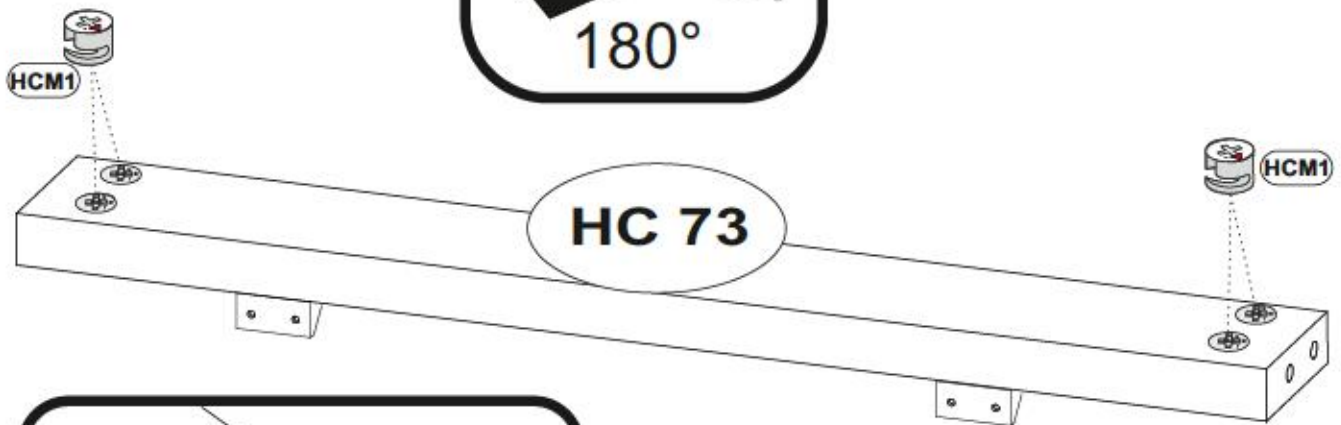
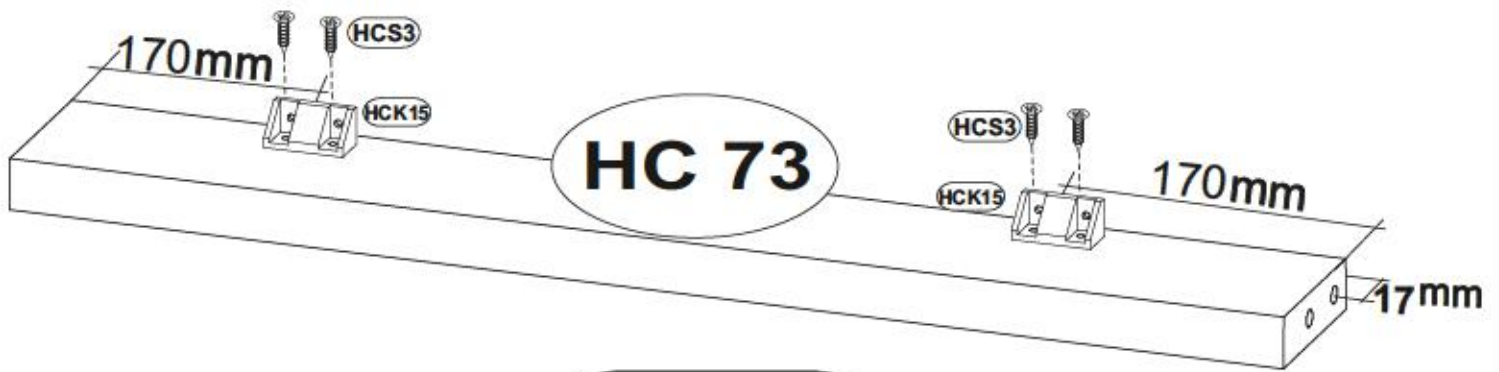
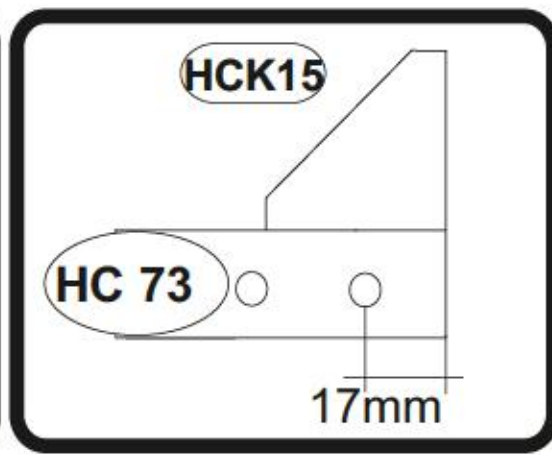
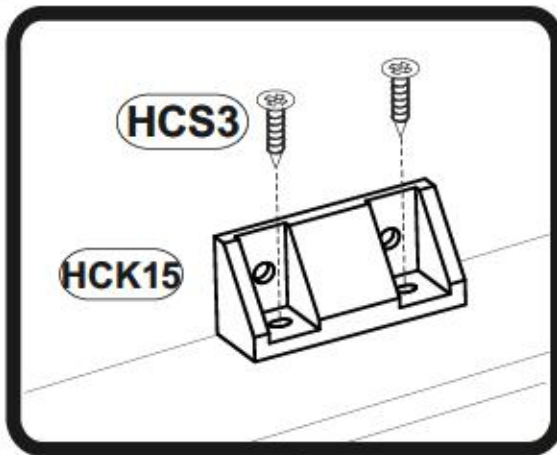

2

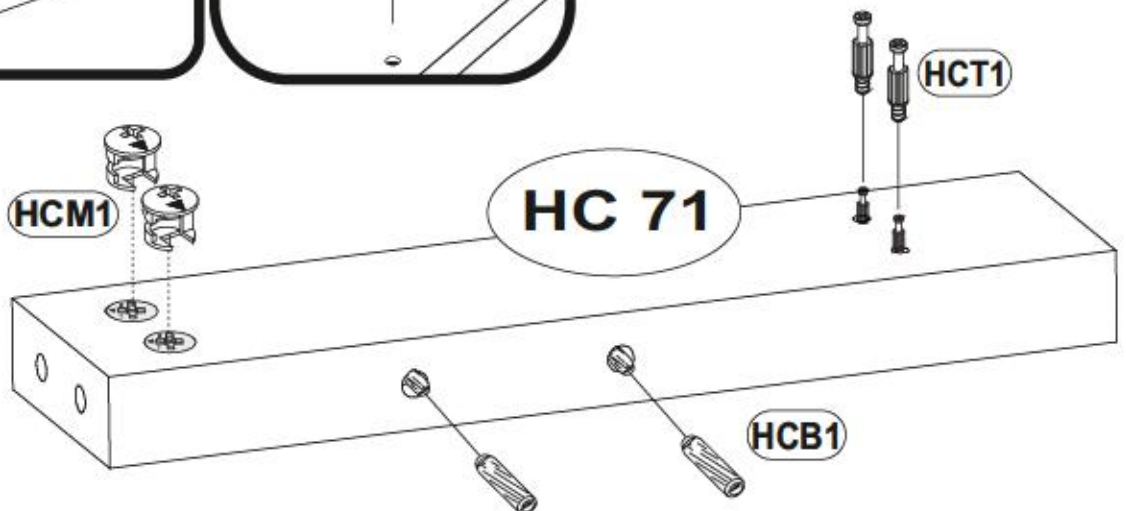
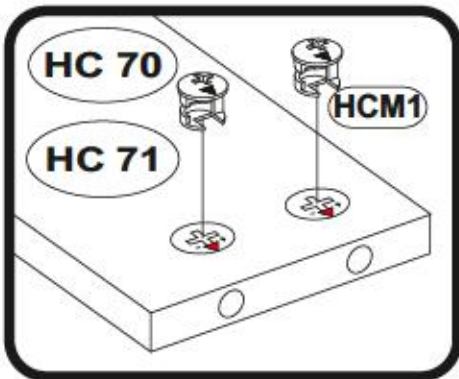
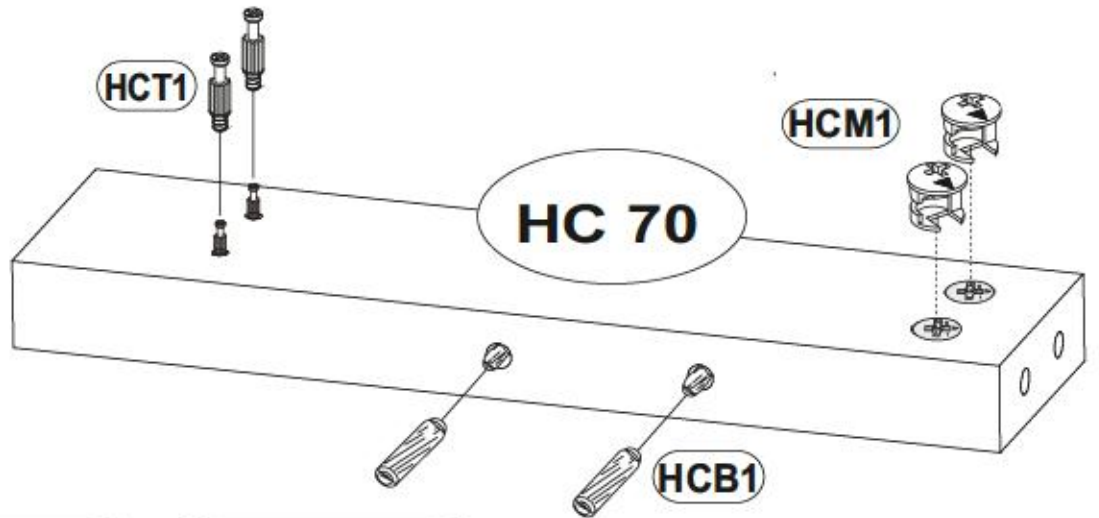
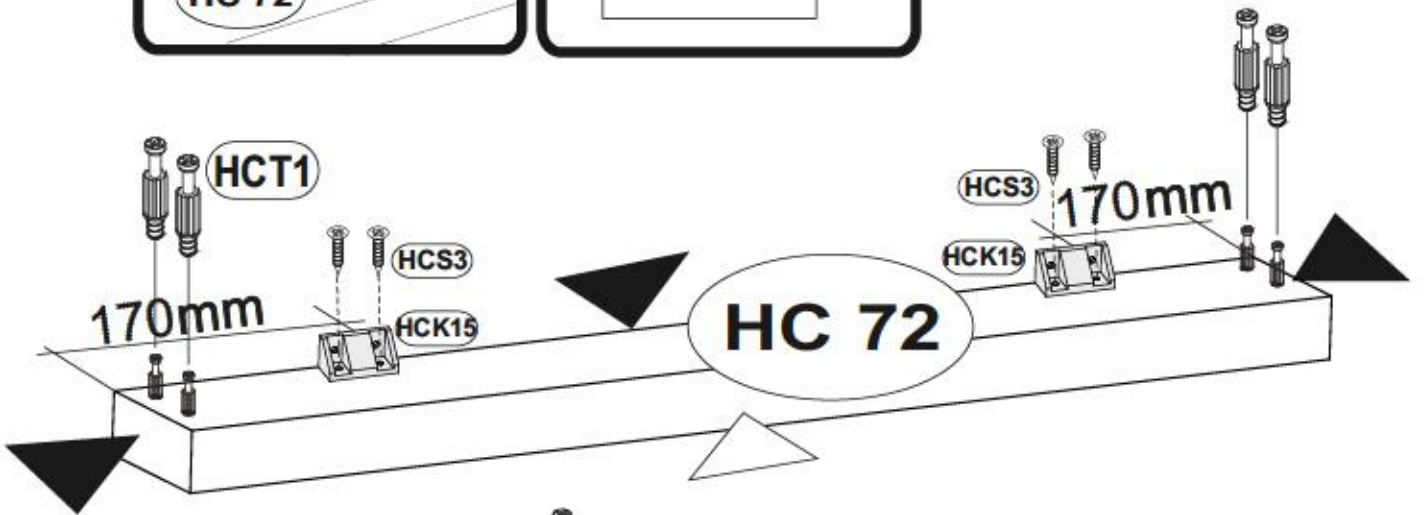
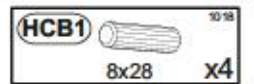
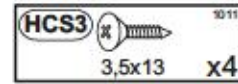
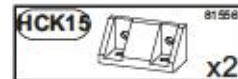
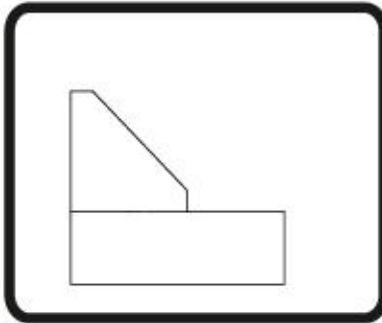
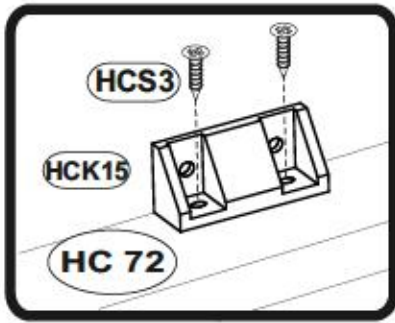

3

HCF36 1305
4x30 x8

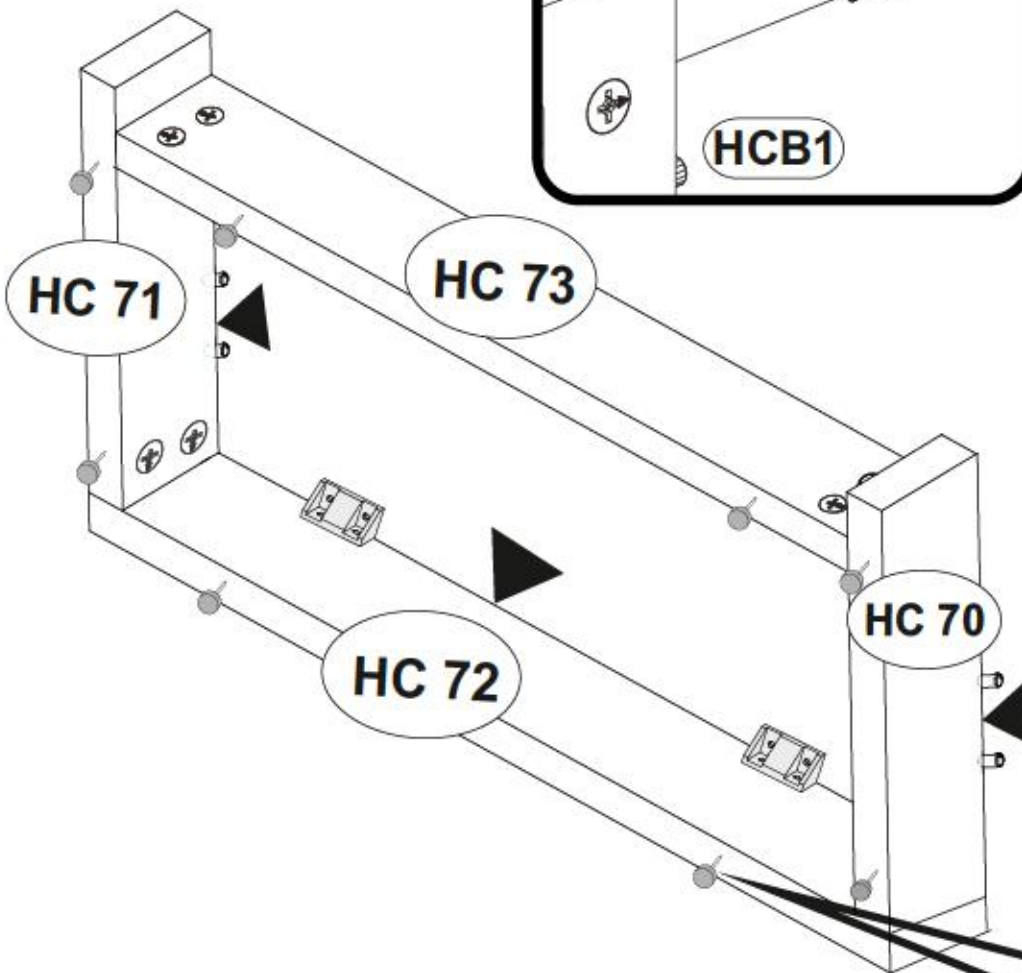
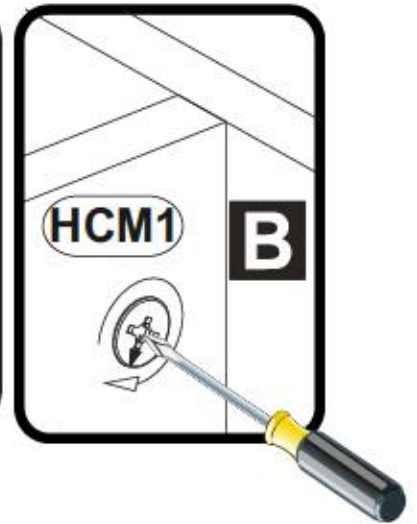
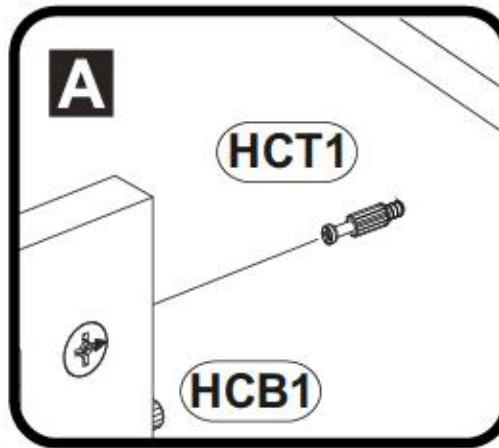
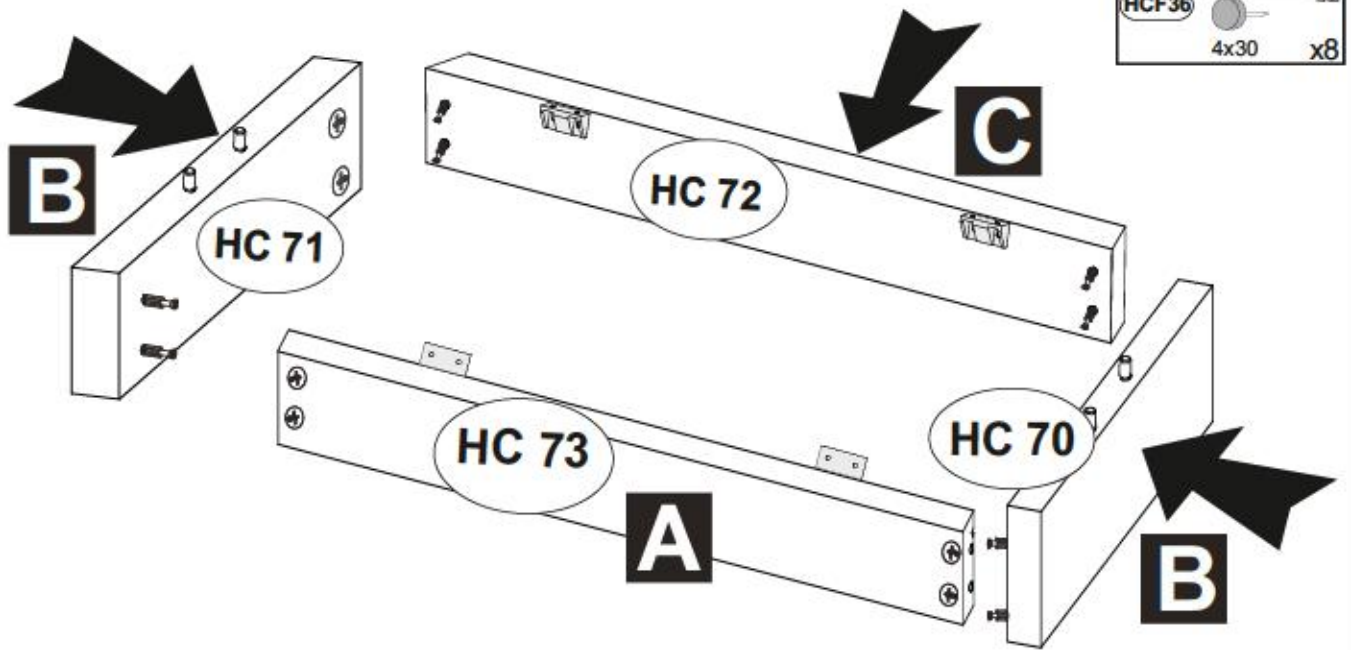

4

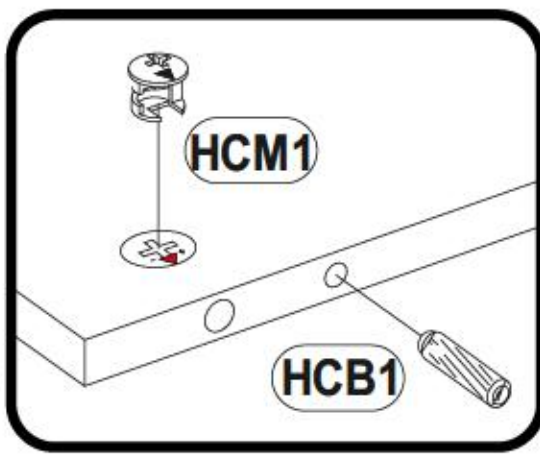
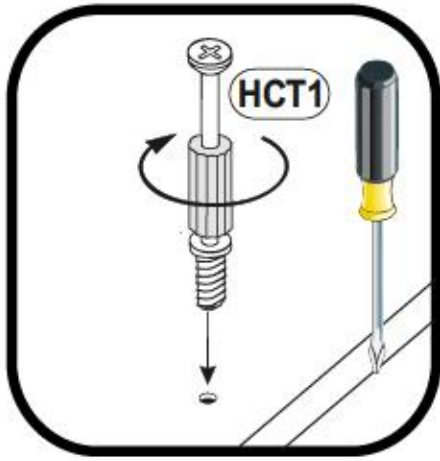

HCB1		1018
	8x28	x4
HCM1		12984
		x4
HCT1		1300
		x8

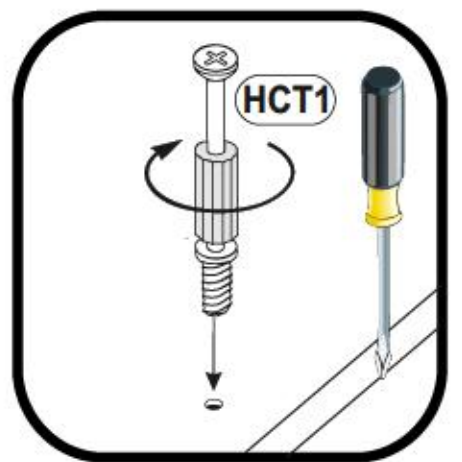
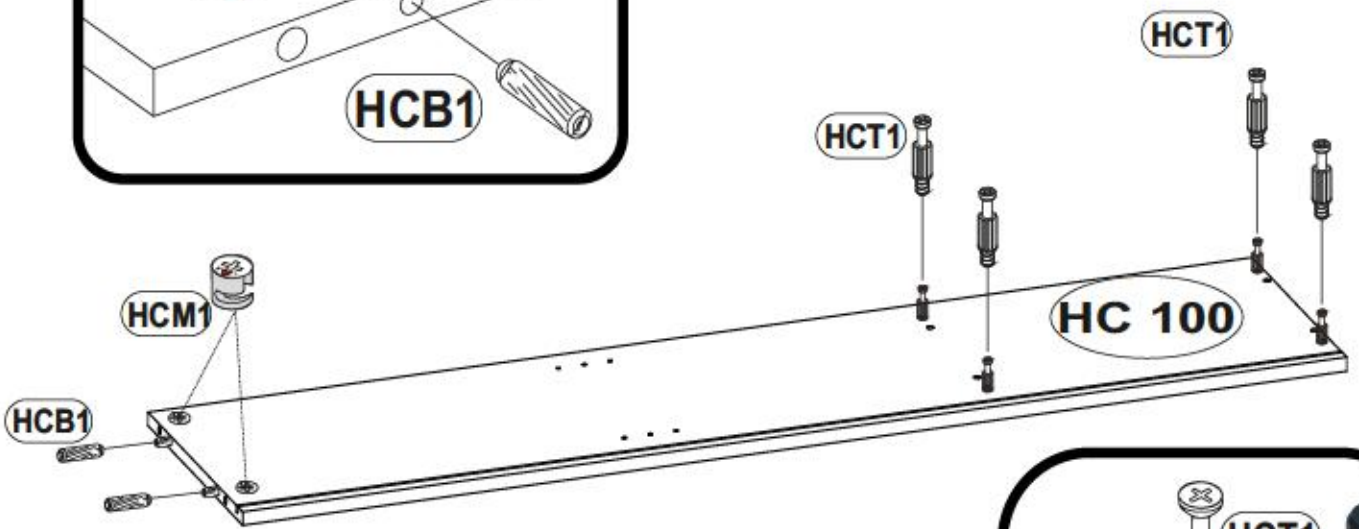
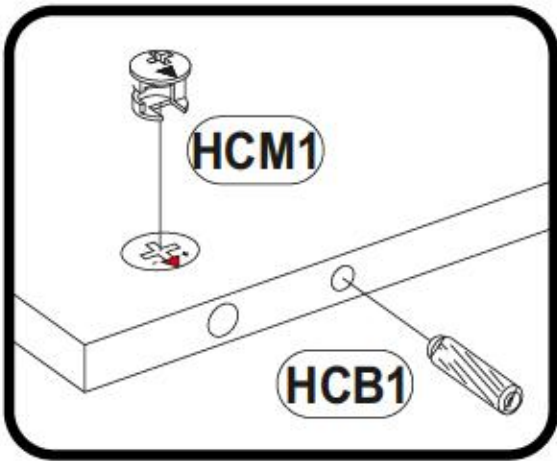
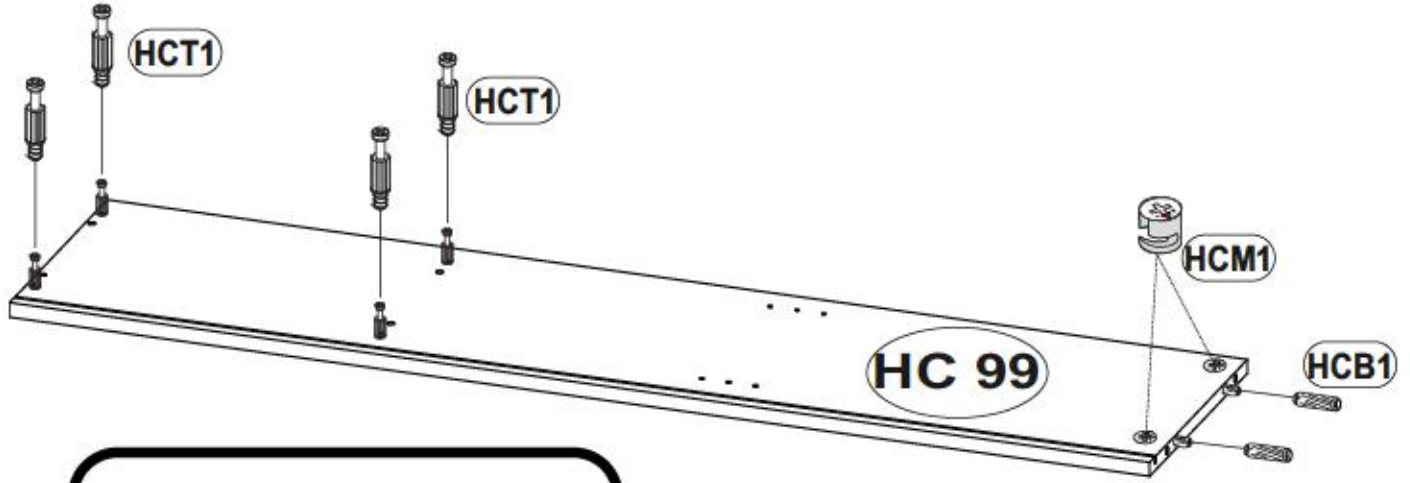

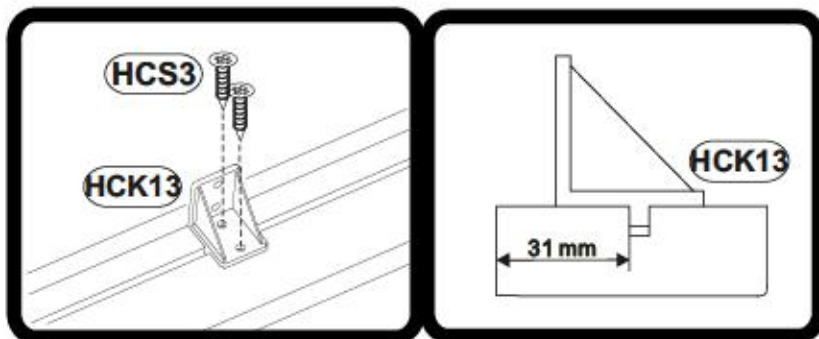
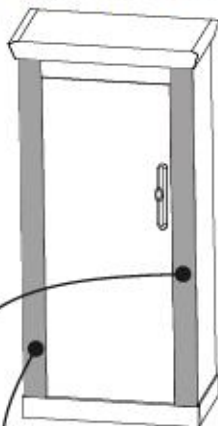
5**OPTION L**

HCS3 3,5x13 x16

HCD14 H4 x2

HCK13 x8

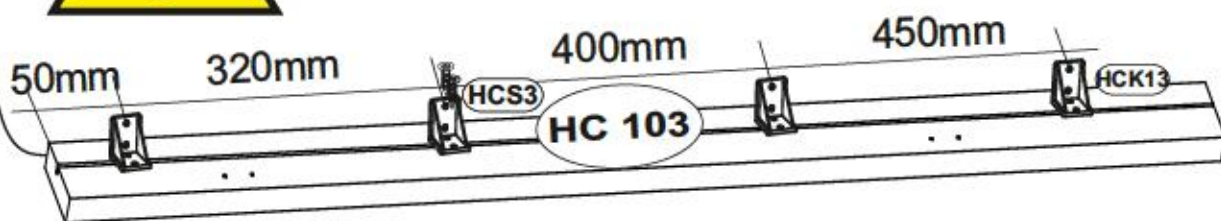
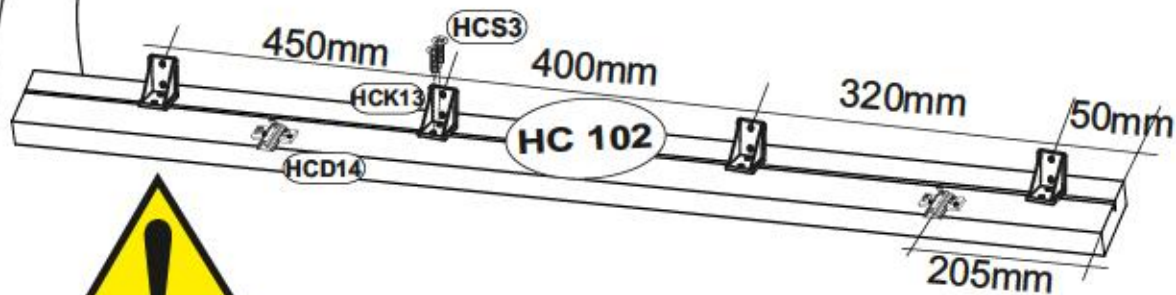
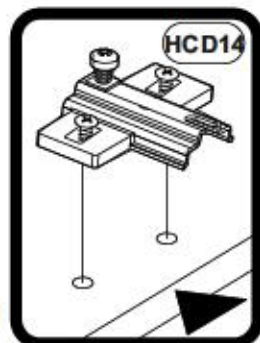
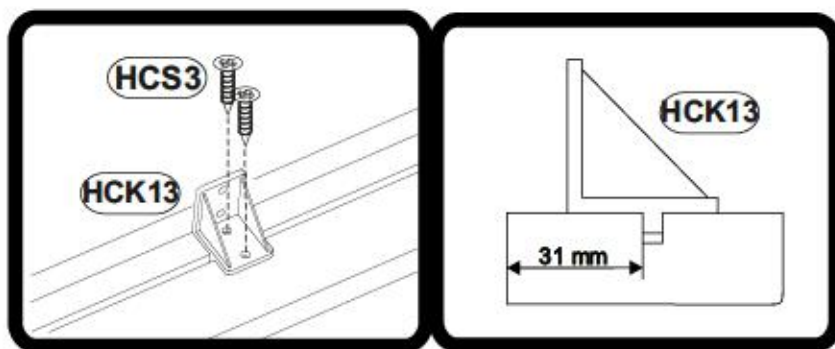
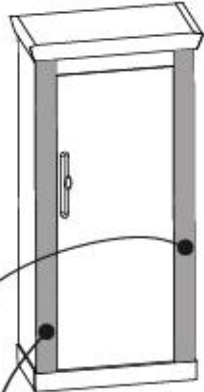
**OPTION R**



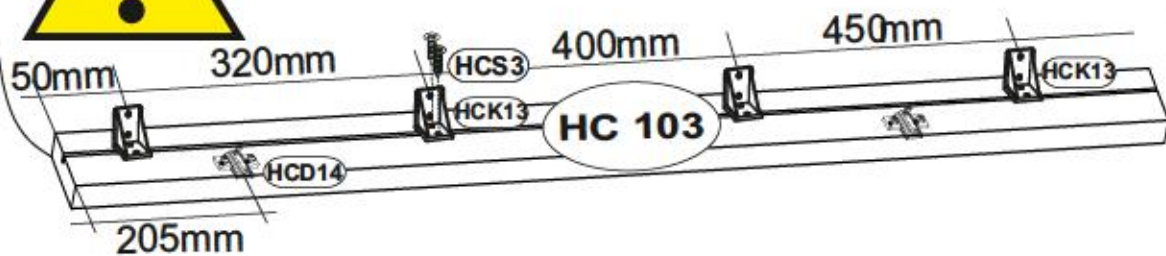
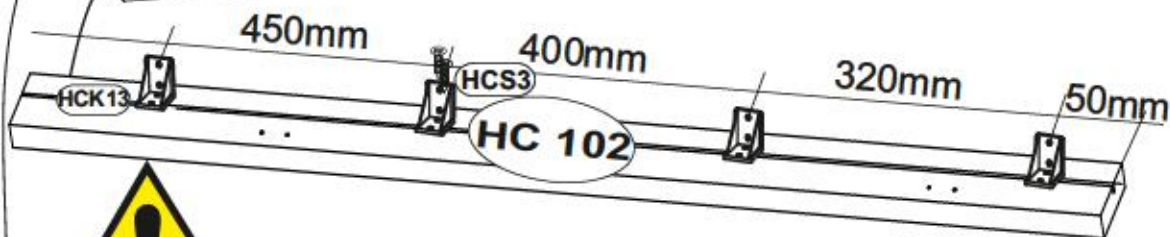
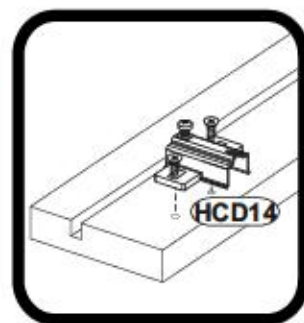

HCS3 3,5x13 x16

HCD14 H4 x2

HCK13 x8



6

HCF14		1021	HCB1		1018
		x2		8x28	x8
HCS3		1011	HCM1		123894
	3,5x13	x4			x8

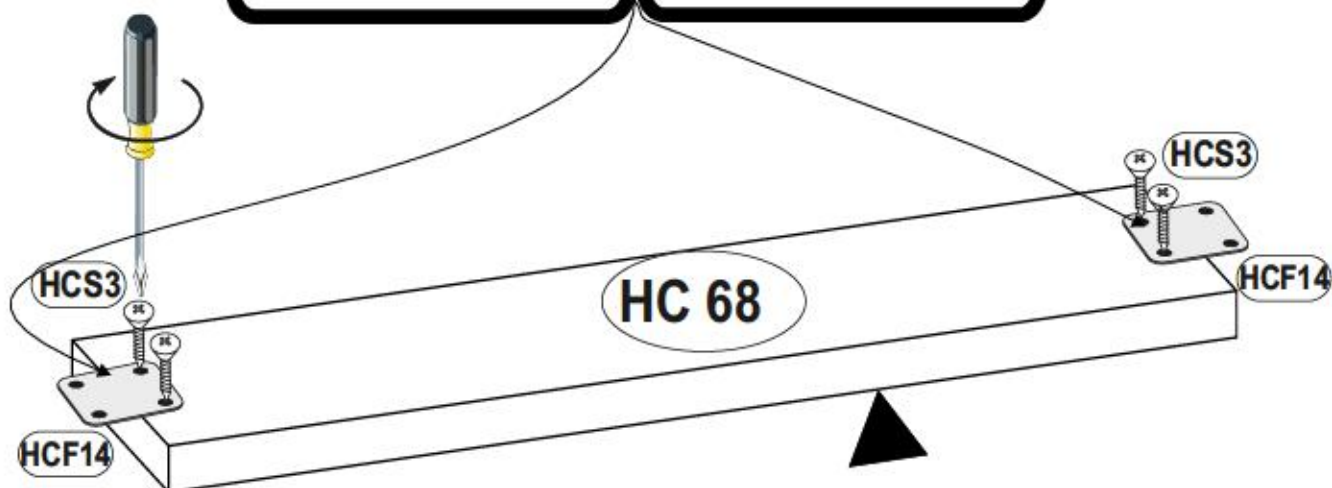
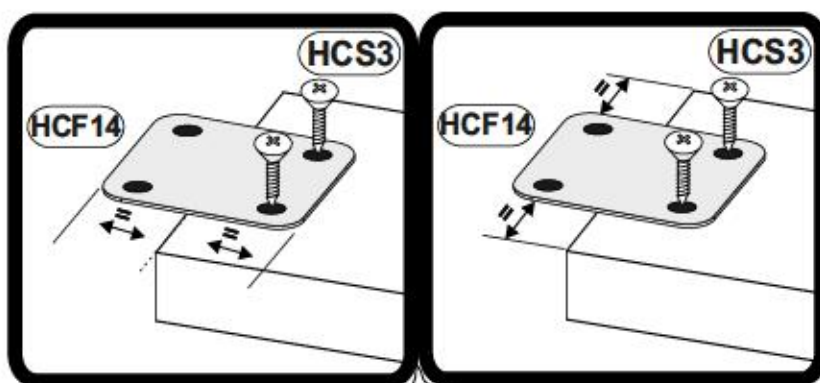
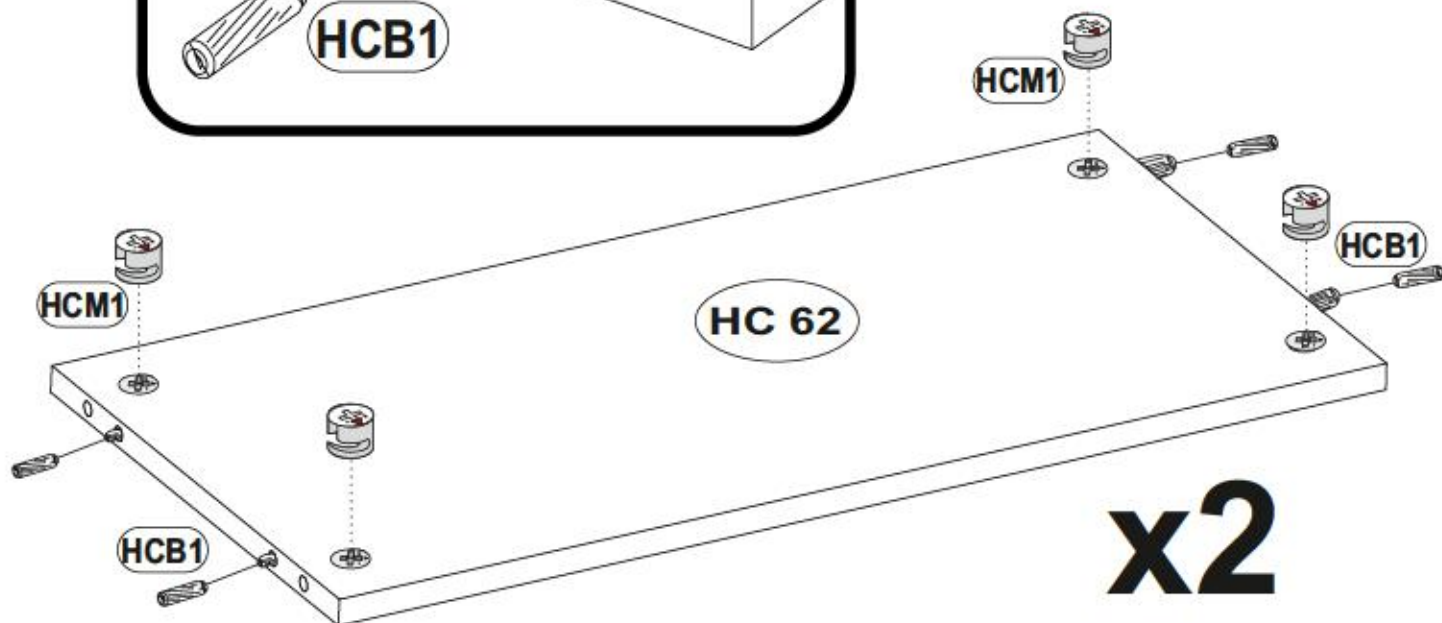
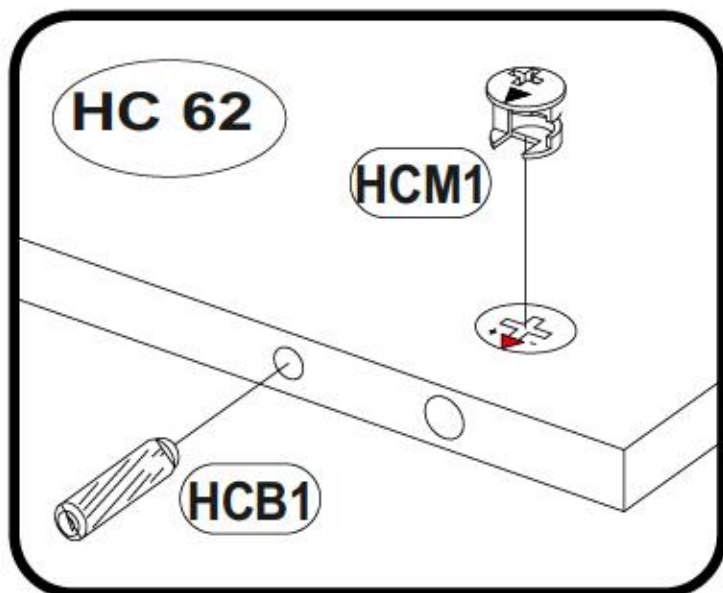

7

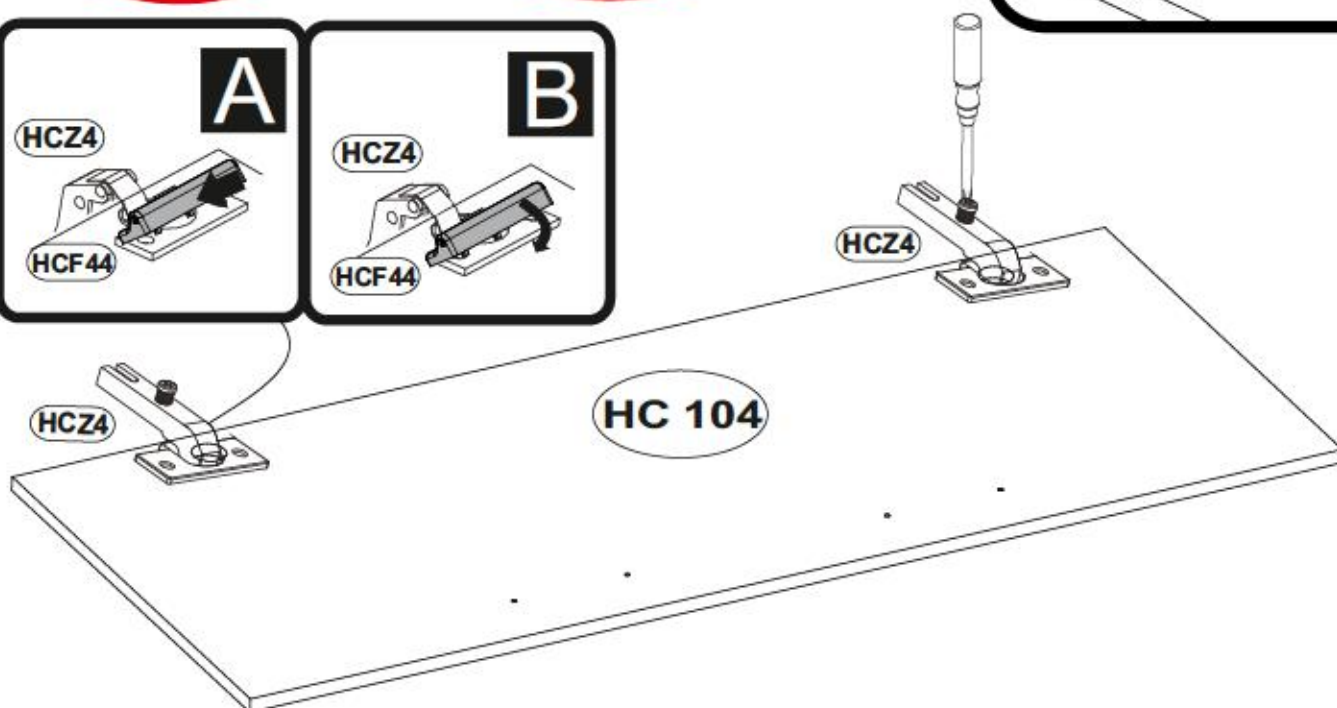
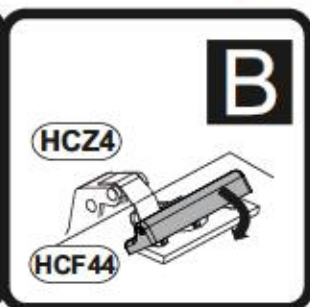
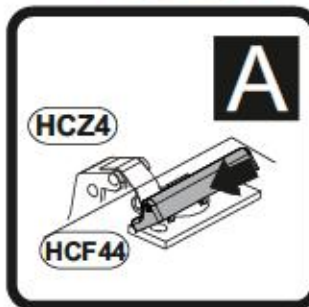
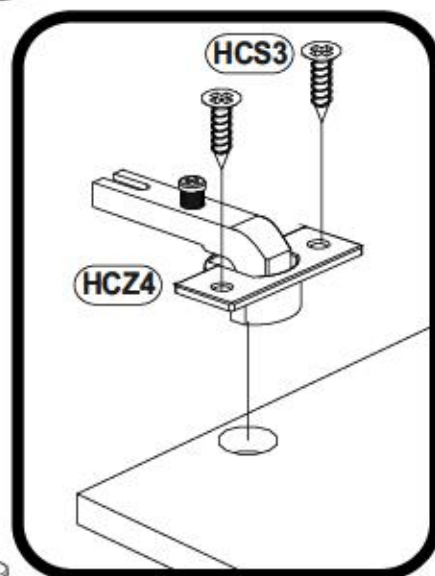
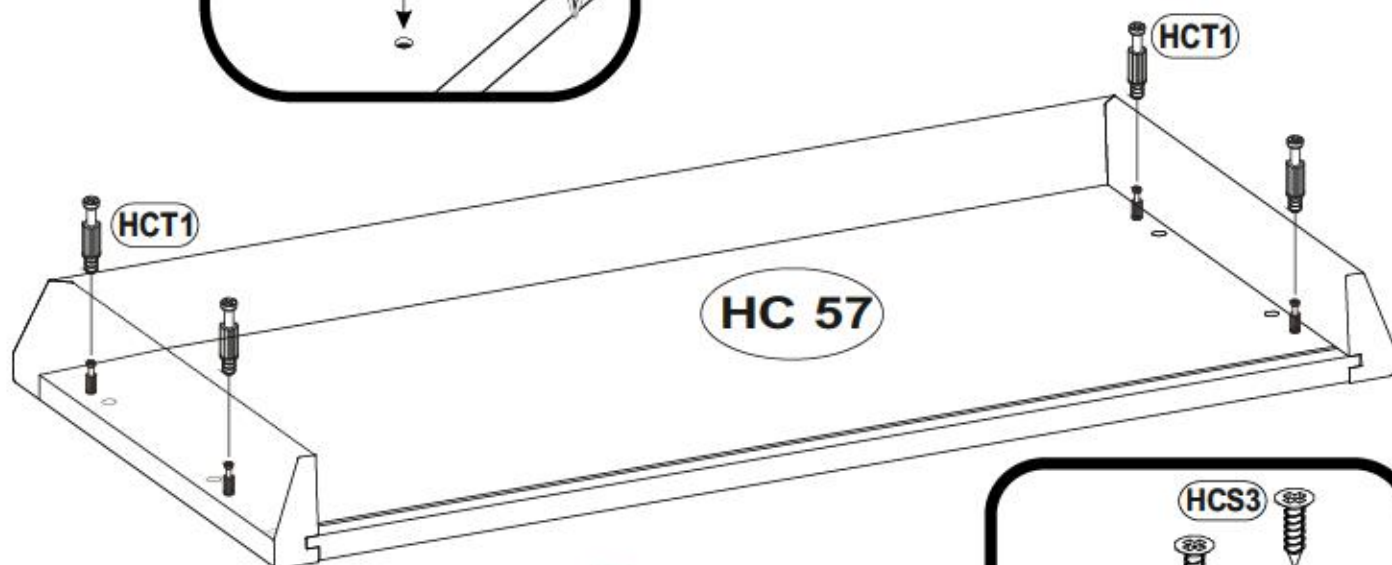
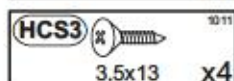
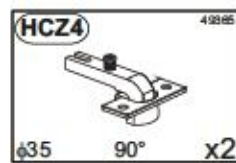
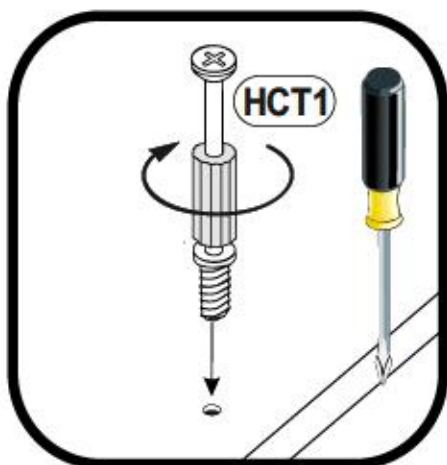

8

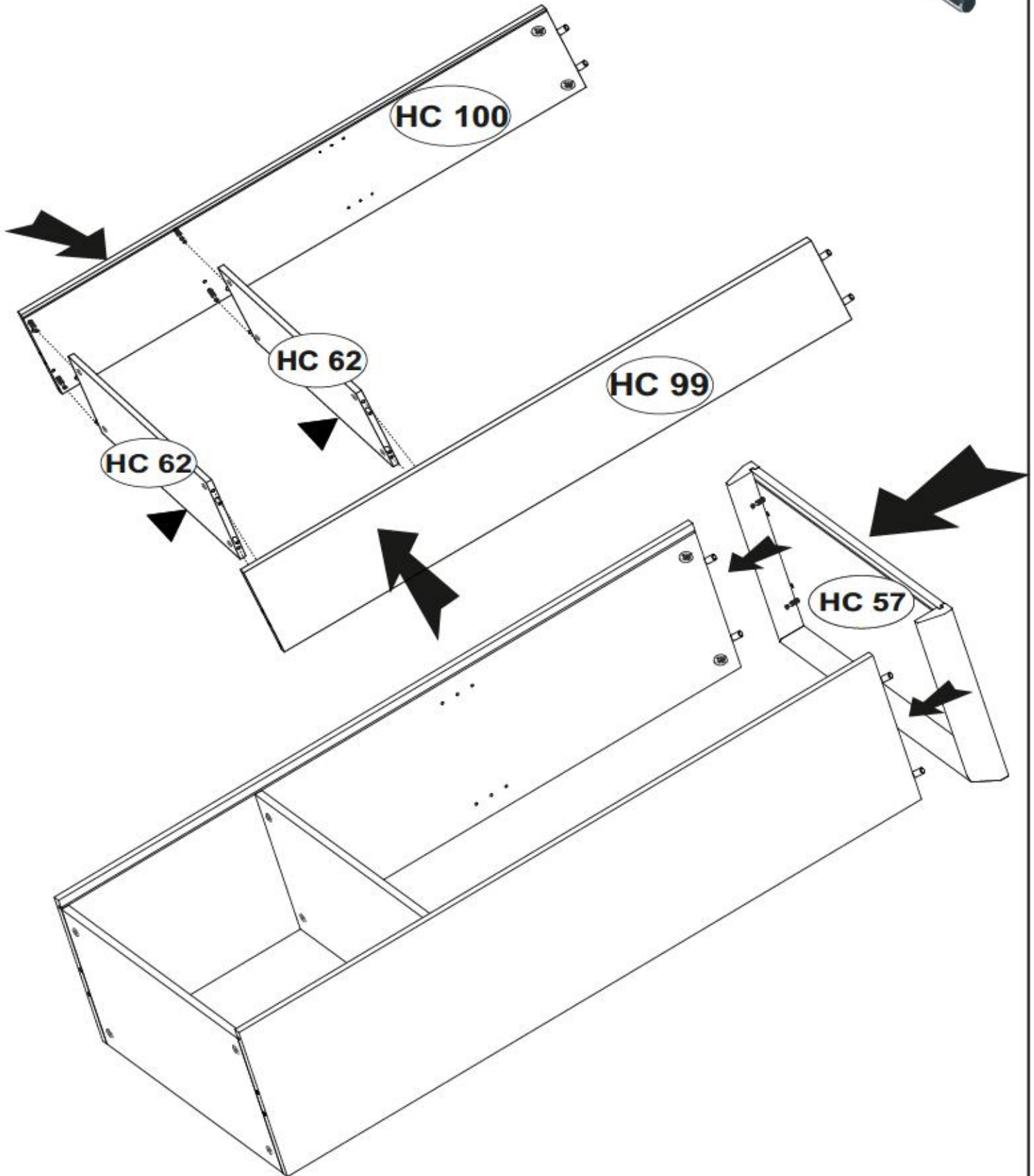
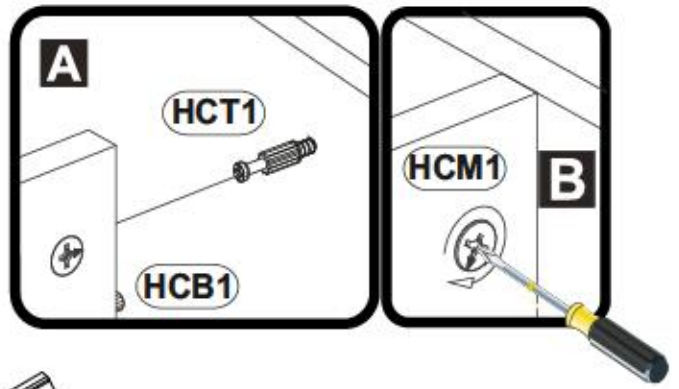

9

HCS3		1011
	3,5x13	x8
HCP6		1056
	3x20	x8
HCJ23		1302
		x10
HCF1		1415
		x4

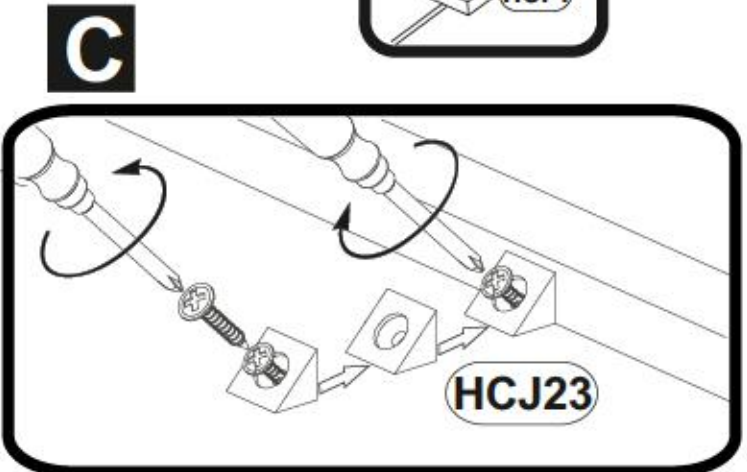
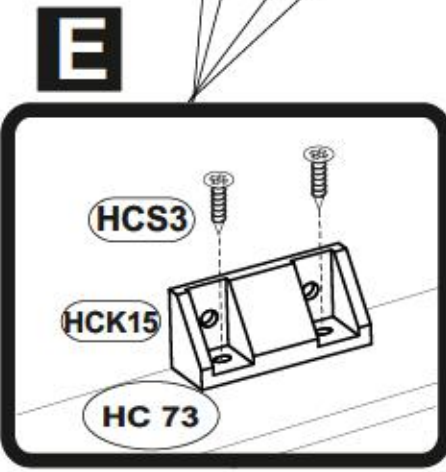
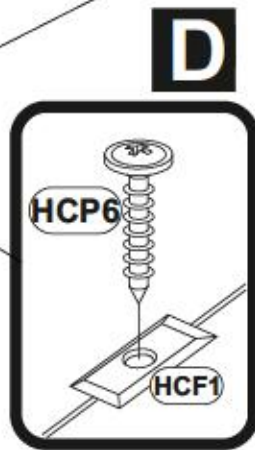
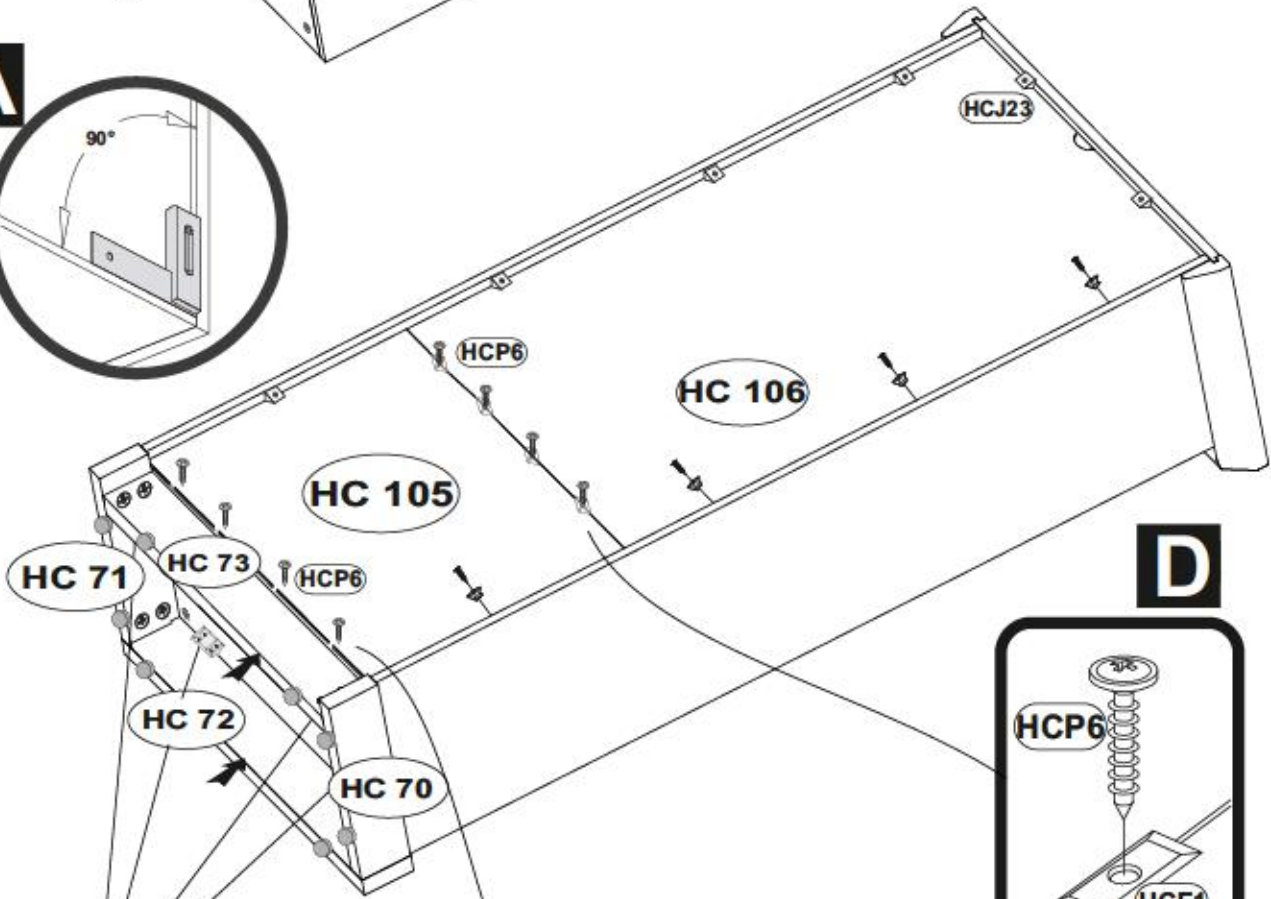
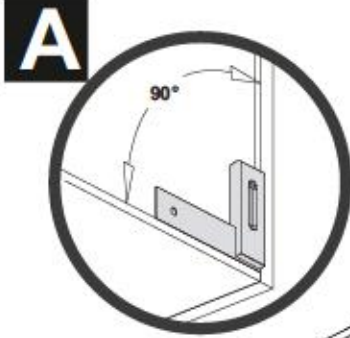
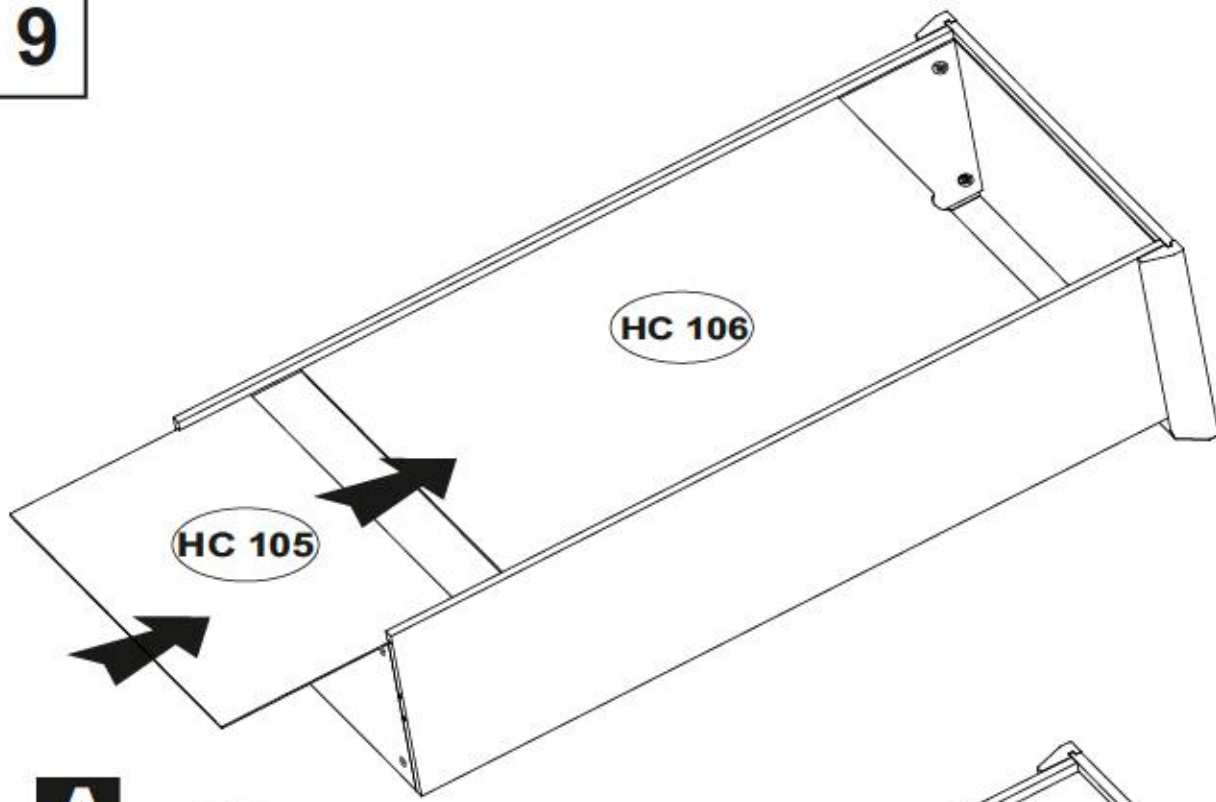

10A

Option L

HCS3	1011
3,5x13	x20
HCW1	1289
	x4
HCJ11	1287
	x1

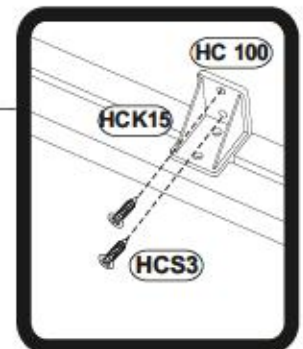
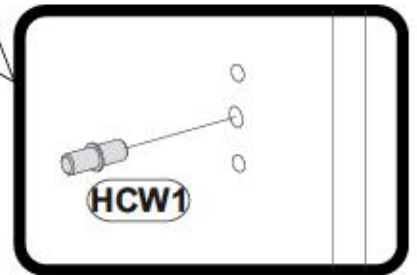
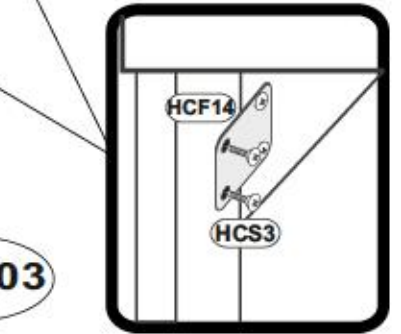
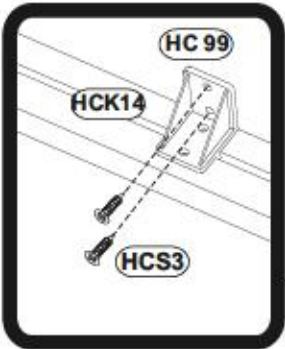
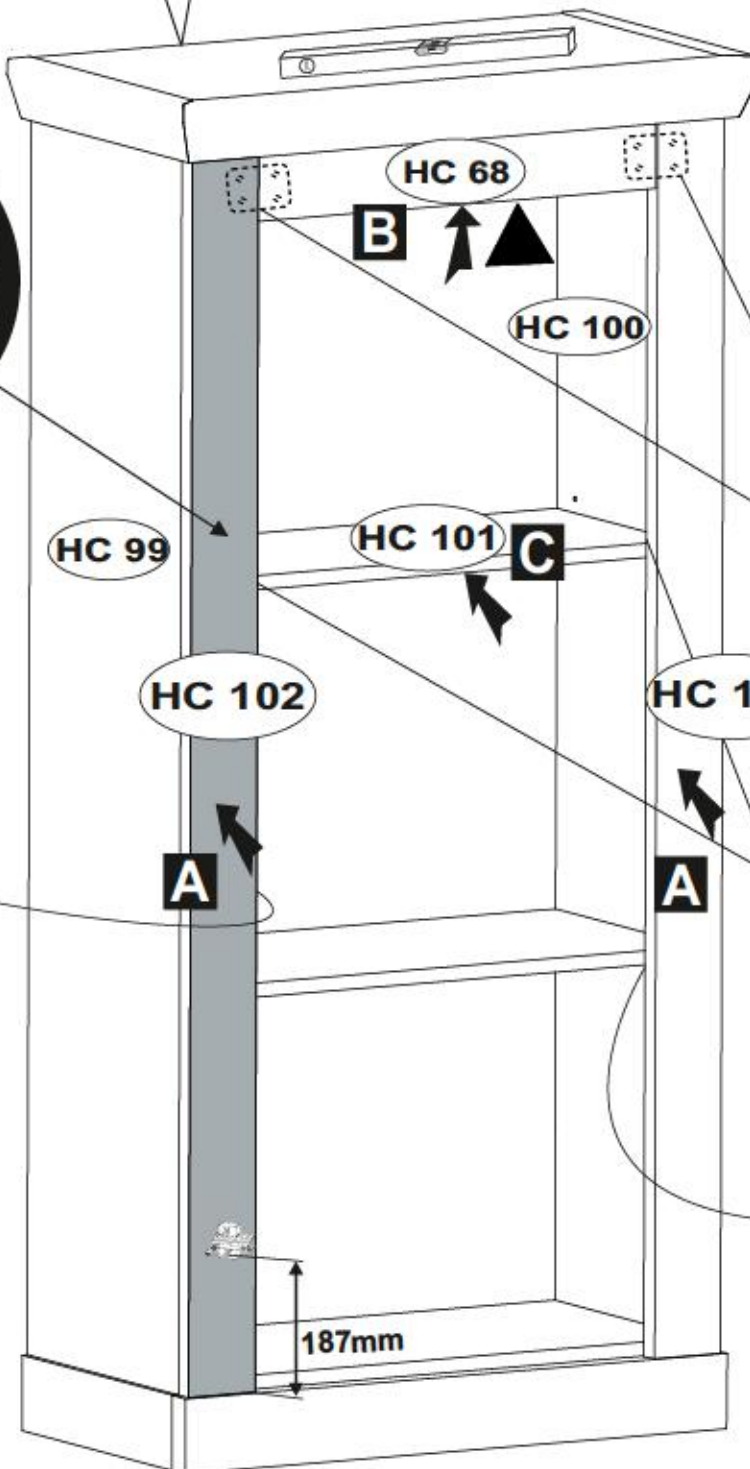
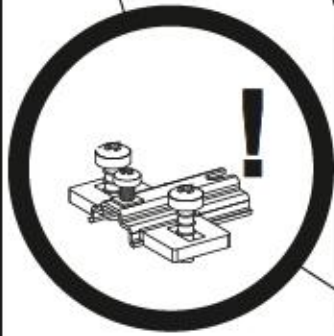
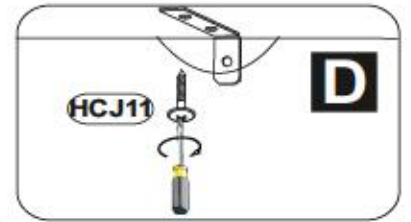
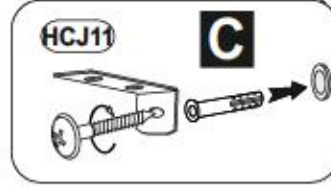
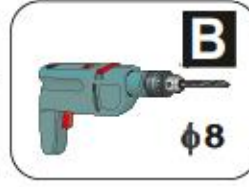
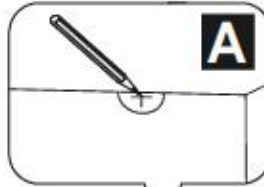
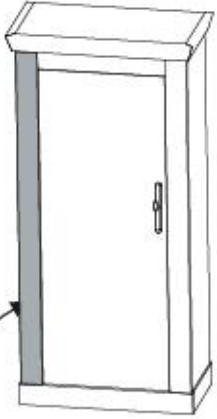
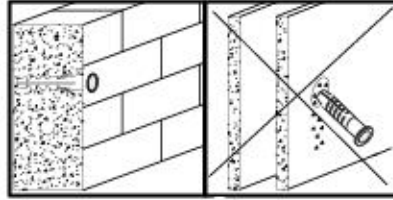

10B

Option R

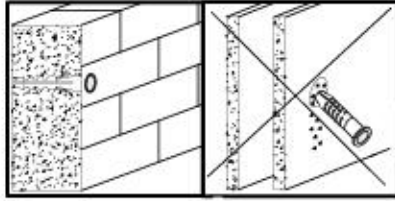

HCS3		1011
	3,5x13	x20
HCW1		1289
		x4
HCJ11		1287
		x1

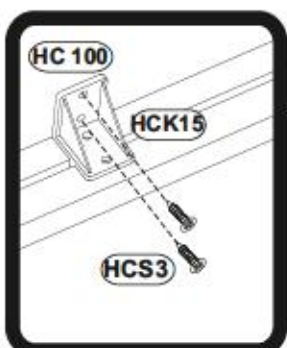
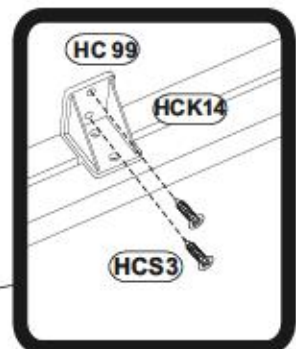
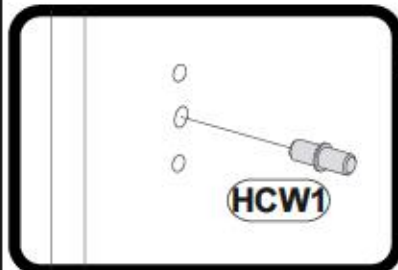
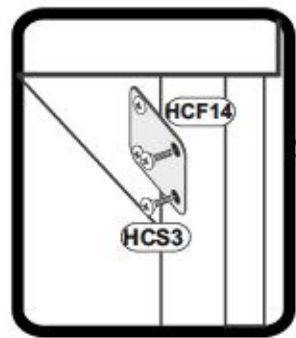
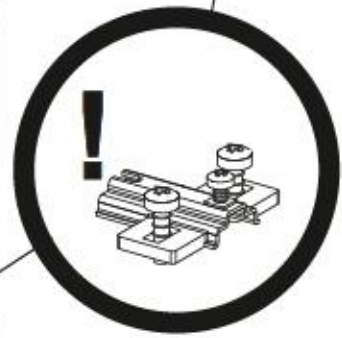
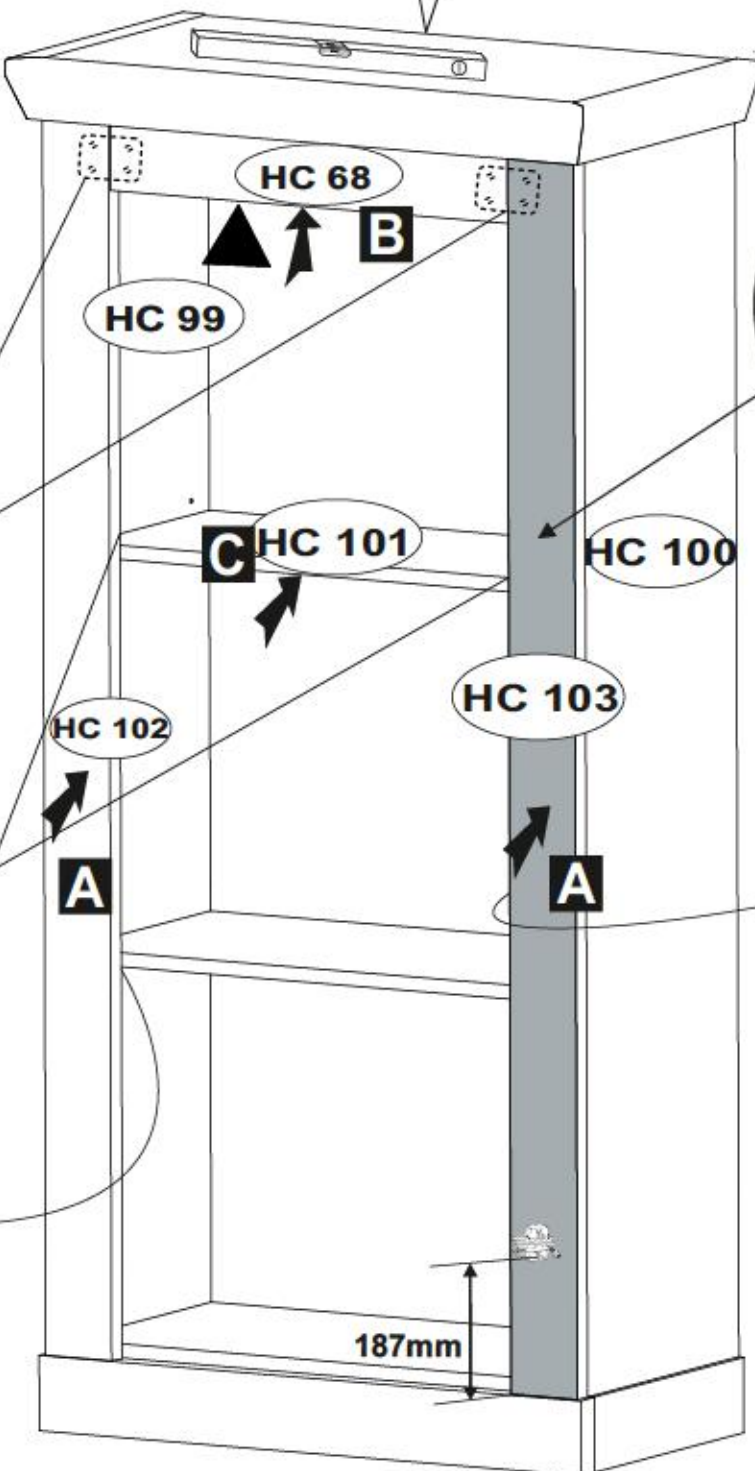
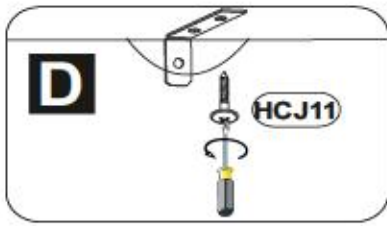
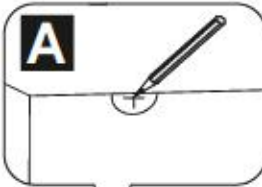
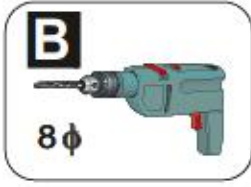
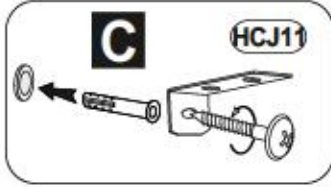

11

OPTION L

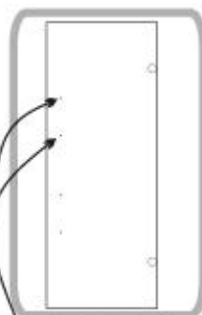
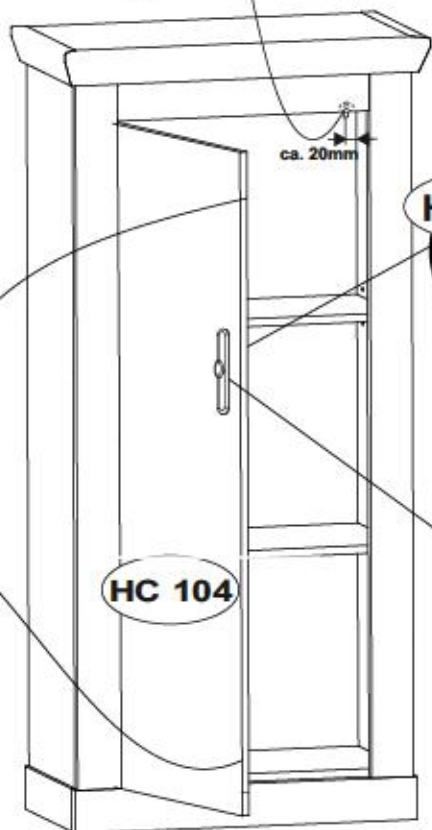
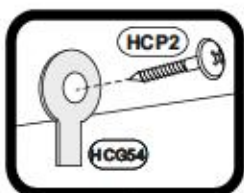

- HCUC160 154338 x1
- HCG54 126880 x1
- HCP2 3014 3,5x13 x1
- HCC6 14217 $\phi 20$ x8
- HCA4 14410 WPM 4x18 x2

HC 104

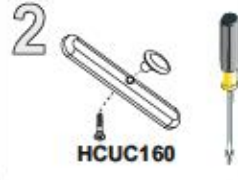
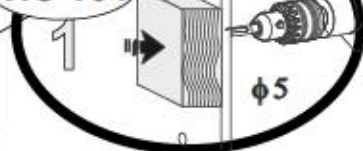

HC 104

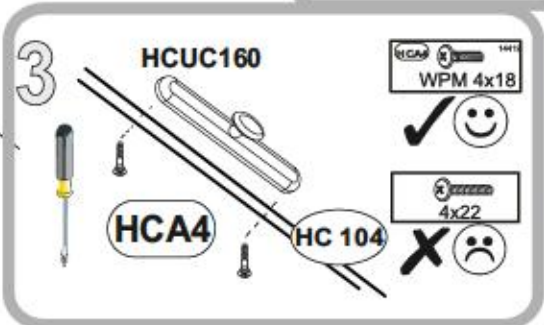

OPTION R

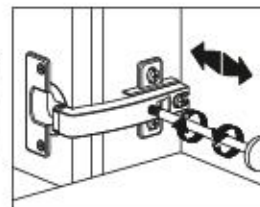
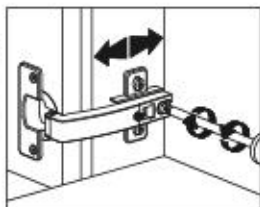
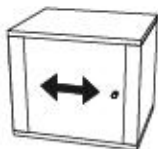
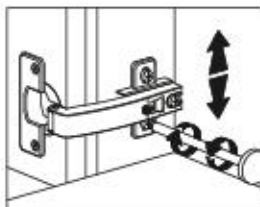
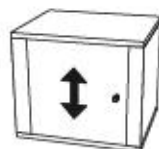
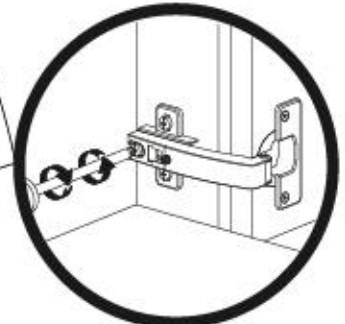
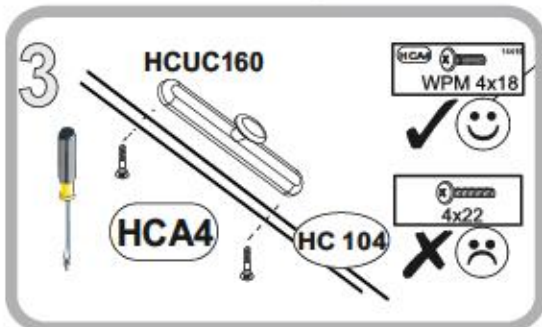
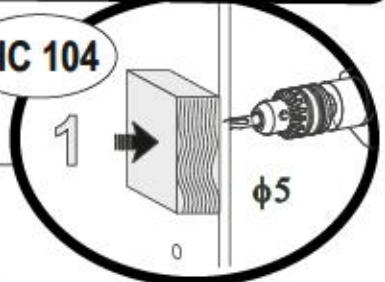
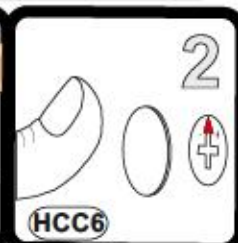
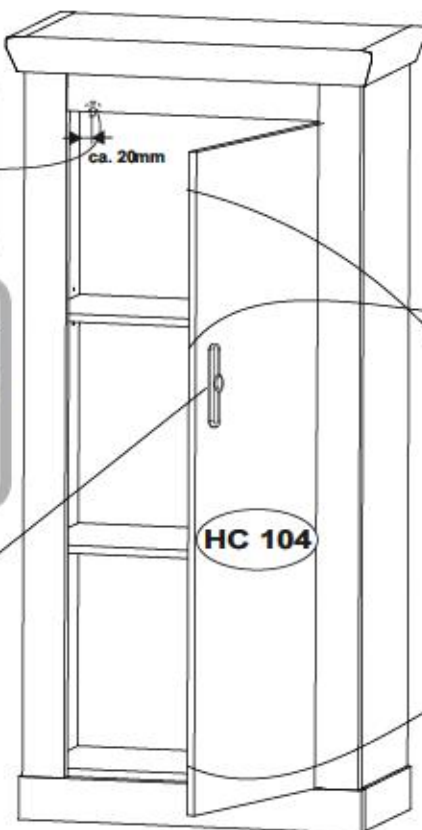
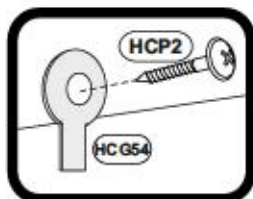
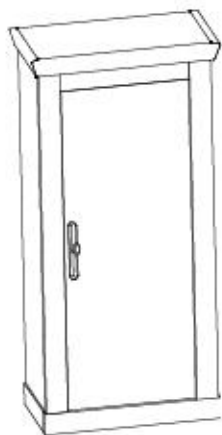

RAVENNA 41

OPTION L

OPTION R

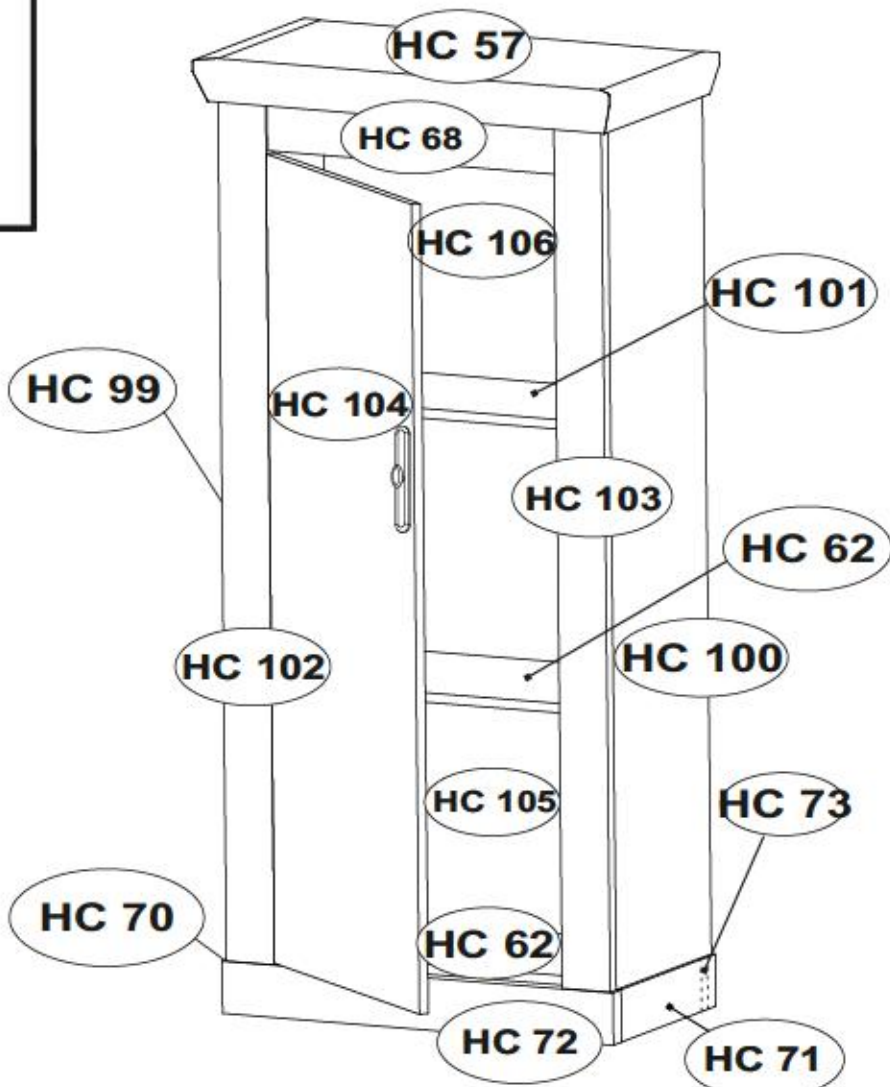

D Umær Dinskráttíðing fyrir þessi gæðfélur. Sölu þín er ein þessig gæðfélur, þótt þú sést þá sérstaklega dín skilningur á þessum málum. Þú getur einnig sýnt þessum gæðfélum á þessum vefsiðum. Sölu þín er ein þessum gæðfélum á þessum vefsiðum, þótt þú sést þá sérstaklega dín skilningur á þessum málum.

GB Our direct order service for fitting. If a fitting part is missing, you can e-mail this service card directly to the address below. However, we can only send fitting parts in this way. If you have any other queries for complaints concerning your item of furniture, please contact your furniture store directly.

CZ Náš přímý službu pro montáž. Pokud vám chybí některá dílčí součást, můžete tuto službu kontaktovat přímo na adresu níže uvedenou. Tato služba vám může poskytnout pouze díly. Pokud máte jakýkoli jiný dotaz, prosíme vás, abyste se obrátili na prodejce nábytku.

F Bien servir la notice de montage. Si vous manquez une pièce, veuillez envoyer directement la présente carte service à l'adresse e-mail indiquée ci-dessous. Cependant, ceci nous permet uniquement d'envoyer des fournitures. Pour tout autre type de réclamation concernant votre meuble, veuillez contacter directement votre magasin d'ameublement.

I Il nostro servizio diretto per l'ordine delle forniture. Qualora vi dovesse mancare un pezzo di falegname, allora vi preghiamo di inviare questo cartello di servizio immediatamente all'indirizzo sotto indicato. Possiamo inviare i pezzi di falegname solamente per mezzo di questo procedimento. Qualora dovete avere qualche altra reclamazione in merito al mobile, allora vi preghiamo di rivolgervi direttamente al Nostro Negozio di mobili.

BG Непосредствено поръчка за обикол. Ако липсва част от мебелта, то трябва да се свържете директно с адреса на е-пощата, посочен по-долу. По този начин можем да доставим само липсващи части от мебелта. Ако искате да направите друга декларация относно мебелта, трябва да се свържете директно с магазините за обзавеждане, от които сте закупили мебелта.

NL Onze directservice voor lossen problemen. Wanneer er een onderdeel ontbreekt, kunt u deze servicekaart direct aan de benodigde e-mailadres sturen. Wij kunnen lange deze weg echter alleen bijbehorende onderdelen versturen. Mocht u een ander probleem aan uw meubel hebben, verzoeken wij u contact op te nemen met uw meubelwinkler.

PL Nasz bezpośredni serwis dla klientów. Jeżeli brakuje części koniecznych do montażu, prosimy o przekazanie nam niniejszej karty serwisowej na niżej podany adres e-mailowy. W ten sposób możemy przesłać Państwu tylko brakujące części. W przypadku innych reklamacji dotyczących mebli, prosimy zgłosić się do sklepu meblowego, w którym został dokonany zakup.

HR Servis za otkaz. U slučaju da nedostaje neki od dijelova mobilnog namještaja, možete nam direktno poslati ovu karticu za servisne dijelove. Na ovaj način mogu vam dostaviti samo dijelove. U slučaju da imate dodatne prigovore vezane uz komad namještaja molimo vas da se obratite našem trgovcu namještaja gdje je isti kupljen.

HU Direktrendelési szolgáltatás. Amennyiben hiányzik a szereléshez szükséges alkatrészek, akkor ezt a kártyát közvetlenül elküldhetjük az alábbi e-mail címre. Csak a hiányzó alkatrészeket tudjuk elküldeni így. Amennyiben másféle reklamációt szeretne tenni a bútorteljesítéssel kapcsolatban, forduljon a boltvezetőhöz a boltjában.

SK Náš priamy servis pre našich klientov. Ak by Vám chýbala niektorá časť k montáži, môžete poslať túto službu priamo na e-mailovú adresu nižšie uvedenú. Môžeme Vám poslať iba tie diely, ktoré sú potrebné. Ak by ste mali iné námietky ohľadom Vašho nábytku, obráťte sa prosím na Vašu predajňu nábytku.

SLO Náš direktni službu storitve za obkole. Če vam manjka kakšna delovna komponenta, lahko to storimo kar direktno po e-pošti določeno na spodnji naslov. Po tej poti vam lahko pošljemo samo delovne. Če želite kakšne druge reklamacije glede pohištva, se obrnite na prodajalno, na katero ste ga kupili.

RO Serviciu directă pentru furnitură. În cazul în care vă lipsește o piesă de lemn sau o piesă de metal, puteți trimite această card de service prin e-mail la adresa de mai jos. Noi nu putem trimite decât piese de lemn sau de metal prin această cale. Dacă aveți o altă reclamație referitoare la piesa de mobilier, atunci vă rugăm să vă adresați direct la magazinul din care a fost cumpărat.

RUS Наш прямой сервис для поставки фурнитуры. Если отсутствует, что Вам не хватает того или иного элемента фурнитуры, Вы можете отправить сервисную карту по адресу нижеприведенному на электронную почту. Однако, только образцы мы можем послать лишь фурнитуры. Если же у Вас имеются иные претензии относительно приобретенной мебели, пожалуйста, обращайтесь непосредственно в магазин, откуда была приобретена продукция.

S Vår direkte service for alle gædfele. Om du mangler en beslagdel kan du skicka detta servicekort direkt till e-postadressen som anges nedan. Vi kan endast skicka de delar som behövs till dessa beslagdelar till dig. Om du vill klargöra din möbel av en annan anledning måste du kontakta ditt möbelför direkt.

ES Nuestro servicio directo para accesorios. Si le falta algún accesorio, puede enviarnos este tarjeta de servicio directamente a la siguiente dirección. No obstante, por este método solo podemos enviar accesorios. Si tiene alguna otra queja sobre su mueble, consulte directamente con su mueblería.

TR Doğrudan hizmet için doğrudan servisimiz. Eğer bir aksesuar eksikse bu servis kartını doğrudan aşağıdaki e-mail adresine göndermeniz mümkündür. Ancak bu yöntemle sadece doğrudan aksesuarlar gönderebiliriz. Mobilyanızla ilgili diğer tüm şikayetleriniz için doğrudan mobilya satıcınıza başvurmanız gerekir.

HC 57	x1	702	372	65	1/1
HC 62	x2	611	299	15	1/1
HC 68	x1	483	124	18	1/1
HC 70	x1	317	80	28	1/1
HC 71	x1	317	80	28	1/1
HC 72	x1	656	80	28	1/1
HC 73	x1	598	80	28	1/1
HC 99	x1	1361	320	15	1/1

HC 100	x1	1361	320	15	1/1
HC 101	x1	610	267	15	1/1
HC 102	x1	1361	80	22	1/1
HC 103	x1	1361	80	22	1/1
HC 104	x1	1231	477	15	1/1
HC 105	x1	421	623	2.5	1/1
HC 106	x1	945	623	2.5	1/1

RAVENNA 41

HCT1 11809

 X...

HCJ23 1302

 X...

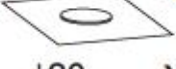
HCW1 1289

 X...

HCF36 1305

 X...

HCC6 140318

 φ20 X...

HCK13 49716

 X...

HCJ11 1267

 X...

HCF1 1415

 X...

HCG54 126680

 X...

HCUC160 154536

 X...

HCA4 14419

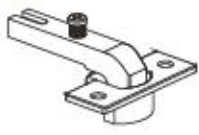
 WPM 4x18 X...

HCZ4 49365

 φ35 90° X...

HCD14 23515

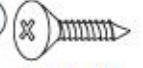
 H4 X...

HCP6 1056

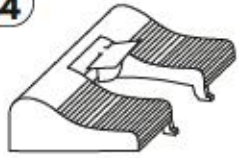
 3x20 X...

HCS3 1011

 3,5x13 X...

HCF14 1021

 X...

F44 116795

 X...

HCB1 1018

 8x28 X...

HCM1 123894

 X...

HCP2 1014

 3,5x13 X...

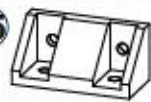
HCK15 81556

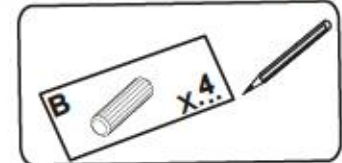
 X...



D Unser Dienstservice für Beschädigte
 Sollte Ihnen ein Beschädigtes fehlen, können Sie diese Servicekarte direkt an die untenstehende Adresse mailen. Wir können eine Bestellung nur Beschädigte auf diesem Wege verschicken. Sollten Sie eine andere Beschreibung an Ihrem Möbelstück haben, so wenden Sie sich bitte direkt an Ihr Möbelhaus.

GB Our direct order service for fitting
 If a fitting part is missing, you can e-mail this service card directly to the address below. However, we can only send fitting parts in this way. If you have any other cause for complaint concerning your item of furniture, please contact your furniture store directly.

CZ Náš přímý službu pro kování
 Chybí-li vám nějaký díl z kování, můžete tuto službu i kartu adresát e-mailem přímo na náš úvodní adresu. Tuto částku však můžeme poslat jen díky kování. Pokud byste nějakou věc jiný díl nábytku, obraťte se přímo na svého prodejce nábytku.

F Bien servi en la notice de montage
 Si vous remarque une erreur, veuillez en voyer une demande de prêtente carte service et l'adresse e-mail indiquée ci-dessous. Cependant, ceci nous permet uniquement d'envoyer des pièces de rechange. Pour tout autre type de réclamation concernant votre meuble, veuillez contacter directement votre magasin d'ameublement.

I Il nostro servizio diretto per l'ordine delle forniture
 Quando Vi dovesse mancare un pezzo di fissaggio, allora Vi preghiamo di inviare questa carta di servizio insieme al presente all'indirizzo sotto indicato. Possiamo inviare i pezzi di fissaggio solamente per mezzo di questo procedimento. Qualora dovete avere qualche altra richiesta o un problema al mobile, allora Vi preghiamo di rivolgerVi direttamente al Vostro Negozio di mobili.

BG Насата директна услуга за обнова
 Ако ви липне част от мебелта, потърсете в инструкцията саркази картата и на е-пошта на е-мил адреса, и докато по-рано. По този начин можем да доставим само запасни компоненти от обнова. Ако устовете други проблеми по мебелта, се свържете директно с обнова на мебелта в магазините, от които сте закупили мебелта.

NL Onze directservice voor loze onderdelen
 Wanneer we een onderdeel ontbrekt, kunt u deze servicekaart direct aan ons dienstadres e-mailen. Wij kunnen lange deze weg echter alleen beschadigden verzenden. Mocht u een ander probleem aan uw meubel hebben, verzaken wij u contact op te nemen met uw meubelzaak.

PL Nasz bezpośredni serwis części meblowych
 Jeżeli brakuje części koniecznych do montażu, prosimy o przesłanie nam niniejszej karty serwisowej na nasz podany adres e-mailowy. W ten sposób możemy przesyłać. Ponadto tylko uszkodzone części. W przypadku innych reklamacji dotyczących mebla, prosimy zgłaszać się do naszego meblowego, w którym zostały dokonany zakup.

HR Servis zaokona
 U slučaju da nedostaje neki od dijelova meblima vas da ne dalje neovlašten mail adresu pošaljete ovaj servisni obrazac. Na ovaj način mogu se dostaviti samo okona. U slučaju da imate dodatne prigovore vezane uz komad namještaja molimo vas da obratite pažnju trgovini trgovini namještaja gdje je isti kupljen.

HU Direktrendelésért a hiányzó részekért
 Ha hiányzik egy részlet, azt a kártyát kitöltve az alábbi címre küldje el. Azonban csak a hiányzó részeket tudunk így küldeni. Amennyiben másféle problémát észlel a furnitúránál, forduljon közvetlenül a boltihoz.

SK Náš přímý servis pro části kování
 Ak by Vám chýbala niekaja časť kování, môžete poslať túto službu kartu a e-mailom na náš úvodný adresu. Tuto časť však môžeme poslať iba kování. Ak by ste mali inú reklamáciu ohľadom Vášho nábytku, obráťte sa priamo na Vašu predajňu nábytku.

SLO Náš direktna služba za delce meblu
 Če vam manjka kakikoli delce, lahko to servisu o kar ni copaljete po e-pošti direktno na spodnji naslov. Po tej poti vam lahko pošljemo samo okonja. Če želite reklamo ali kakšen drug del poročila, se obrnite neposredno na vašo trgovino poročila.

RO Serviciu directă pentru piesele
 În cazul în care vă lipsește o piesă de mobilier, puteți să trimiteți această card de serviciu prin e-mail la adresa de mai jos. Noi nu putem trimite decât piesele de mobilier defecte pe această cale. Dacă aveți o altă reclamație referitoare la piesa de mobilier, atunci vă rugăm să vă adresați direct la magazinul dvs. de mobilier.

RUS Наш прямой сервис для поставки фурнитуры
 Если отсутствует, что Вам необходимо для сборки мебели, то просим Вас направить заявку на нашу электронную почту. Однако, только поврежденные детали мебели мы можем доставить только таким образом. Если у Вас имеются другие претензии относительно приобретенной мебели, пожалуйста, обращайтесь непосредственно в магазин, где была приобретена мебель.

S Vår direkte service för beskadigade
 Om du saknar en beskadigad del du ska skicka detta servicekort direkt till e-postadressen som anges nedan. Tänk på att det är den enda möjligheten att skicka beskadigade delar. Om du vill reklamera din möbel av en annan anledning måste du kontakta ditt möbelhus direkt.

ES Nuestro servicio directo para accesorios
 Si le falta algún accesorio, puede enviarnos este tarjeta de servicio de reemplazo a la siguiente dirección. No obstante, por este medio solo podemos enviar accesorios. Si tiene alguna otra objeción sobre su mueble, consulte directamente con su mueblería.

TR Doğrudan sipariş hizmeti
 Bir ürününüz eksikse bu servise kartini dogrudan ilgili satilma adrese dogrudan mail ile iletiniz. Sadece bu yolla donatileri gonderilebiliriz. Mobilyenizle ilgili baska sulyelemleri veya baska dogrudan mobilya satilma adresine yapiniz.