

245FCA24

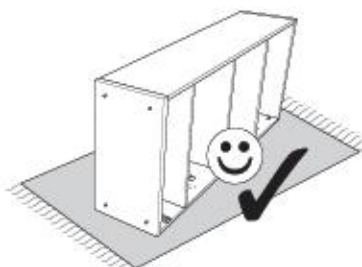
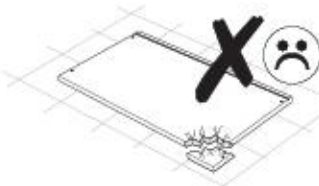
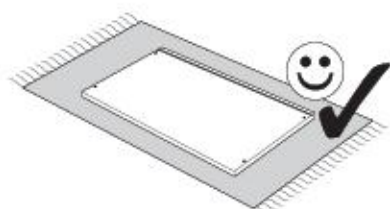
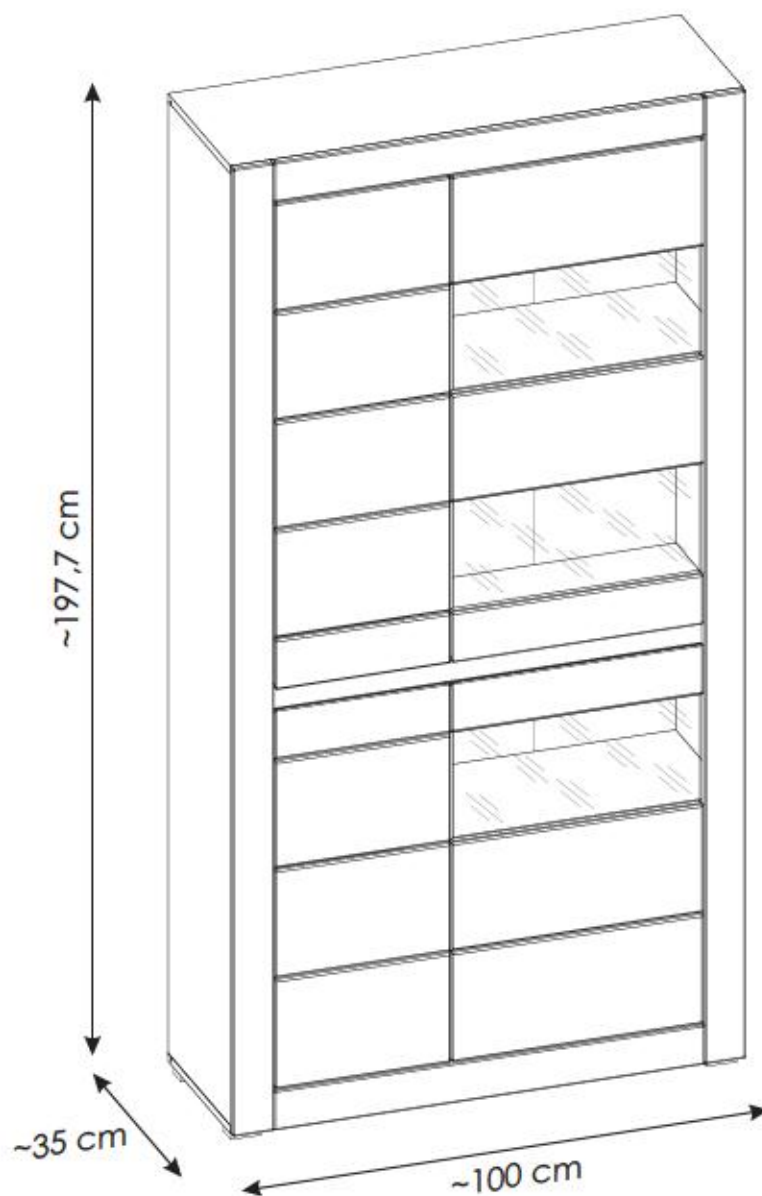

ملاحظة!

يجب تثبيت الأثاث بإحكام إلى الحائط أو الجدار لتجنب خطر إنقلابه. لا تحتوي العلبه على مسامير التثبيت، إذ إنه ينبغي إستعمال المسامير المخصصة لنوعية الحائط أو الجدار. اختر المسامير التي تناسب جدارك.

E.

¡ATENCIÓN! El mueble debe ser fijado permanentemente a la pared para evitar el riesgo relacionado con el vuelco del mueble. En el paquete no hay tornillos de fijación, ya que se debe elegir el tipo de fijación adecuado para el tipo de pared. Elija el apropiado para su tipo de pared.

CN.

注意！本家具需要固定在墙上以免倒塌。箱子里没有安装螺钉。因为安装方式需要根据墙的类型调整。请按照您的墙类型选择合适的安装方式。

SLO.

POZOR! Pohištvo trajno pritrdite na steno, da preprečite tveganje, da se prevrne. V paketu ni pritrdilnih vijakov, saj je treba način pritrditve ustrezno izbrati glede na vrsto stene. Izberite način, ki je ustrezen za vašo steno.

HU.

FIGYELEM! Rögzítse a bútorokat a falhoz, hogy elkerülje a bútor felborulásának kockázatát. A készletben nem találhatóak rögzítőcsavarok, mivel a rögzítés típusa a fal típusától függ. Válassza ki a fal típusának megfelelő kötőelemeket.

NL.

OPMERKING! De meubelen moeten permanent aan de muur worden bevestigd om te voorkomen dat de meubelen kantelen. Er zitten geen bevestigingsschroeven in het pakket, omdat het type bevestiging moet worden gekozen op basis van het type muur. Kies de juiste voor uw type muur.

EN.

WARNING! To prevent this furniture from tripping over, fix it to the wall permanently. Fixing devices are not included since different wall materials require different types of fixing devices. Please make sure you chose the correct ones for your type of wall.

SK.

POZORI Nábytok musí byť trvalo pripevnený k stene tak, aby sa zamedzilo riziku prevrátenia. Balík neobsahuje upevňovacie skrutky, pretože typ upevnenia je treba vybrať podľa typu steny. Vyberte typ vhodný pre Vašu stenu.

CZ.

POZORI Nábytek je nutné pevně připevnit ke zdi, abychom se vyhnuli riziku spojenému s jeho převrnutím. Součástí balení nejsou připevňovací šrouby, protože způsoby připevnění je nutné zvolit podle druhu stěny. Vyberte správný pro Váš typ stěny.

RU.

ПРИМЕЧАНИЕ! Эту мебель необходимо всегда прикреплять к стене, чтобы избежать рисков, связанных с переворотом мебели. В пакете нет крепежных винтов, потому что тип крепления должен быть выбран в соответствии с типом стены. Выберите, пожалуйста, правильные винты к вашей стене.

RO.

ATENȚIE! Mobila trebuie ancorată permanent în perete pentru a evita riscul de răsturnare a mobilei. În pachet nu sunt incluse șuruburile de fixare, deoarece tipul de ancoraj trebuie ales în funcție de tipul de perete. Alegeți șuruburile potrivite pentru tipul Dvs. de perete.

TR.

DIKKATİ! Devrimle riskini önlemek için mobilya duvara sabitlenmelidir. Sabitleme civataları pakete dahil değildir, çünkü sabitleme tertibatının tipi, duvara tipine uygun olarak seçilmelidir. Onu duvannızın tipine göre seçiniz.

PL.

UWAGA! Mebel należy trwale zamocować do ściany, aby uniknąć ryzyka związanego z przewróceniem się mebla. W paczce nie ma śrub mocujących, ponieważ rodzaj mocowania należy odpowiednio dobrać do rodzaju ściany. Dobierz właściwe do Twojego rodzaju ściany.

D.

ACHTUNG! Um alle mit dem Umkippen des Möbels verbundenen Risiken auszuschließen, muss das Möbel fest an der Wand verankert werden. Beschläge für die Wandbefestigung sind nicht beige packt, da diese von der jeweiligen Wandbeschaffenheit abhängig sind. Bitte solche Befestigungsschläge wählen, die für die heimischen Wände geeignet sind.

FR.

ATTENTION! Ce meuble doit être fixé en permanence au mur pour éviter les risques de chute. Les vis de fixation ne sont pas livrées car le type de fixation doit être choisi en fonction du type de mur. Sélectionnez les fixations adaptées au mur.

I.

ATTENZIONE! Il mobile deve essere permanentemente fissato alla parete per evitare i rischi derivanti da un ribaltamento del mobile. La confezione non include le viti di fissaggio, in quanto il tipo di fissaggio deve essere scelto in base al tipo di parete. Utilizzare viti appropriate in base al materiale della parete.

HR.

NAPOMENA! Namještaj mora biti trajno pričvršćen za zid, kako bi se izbjegao rizik od njegovog prevrtanja. U paketu nema vijaka za pričvršćivanje, jer se vrsta montaže mora prilagoditi vrsti zida. Odaberite pravu vrstu prema Vašoj vrsti zida.

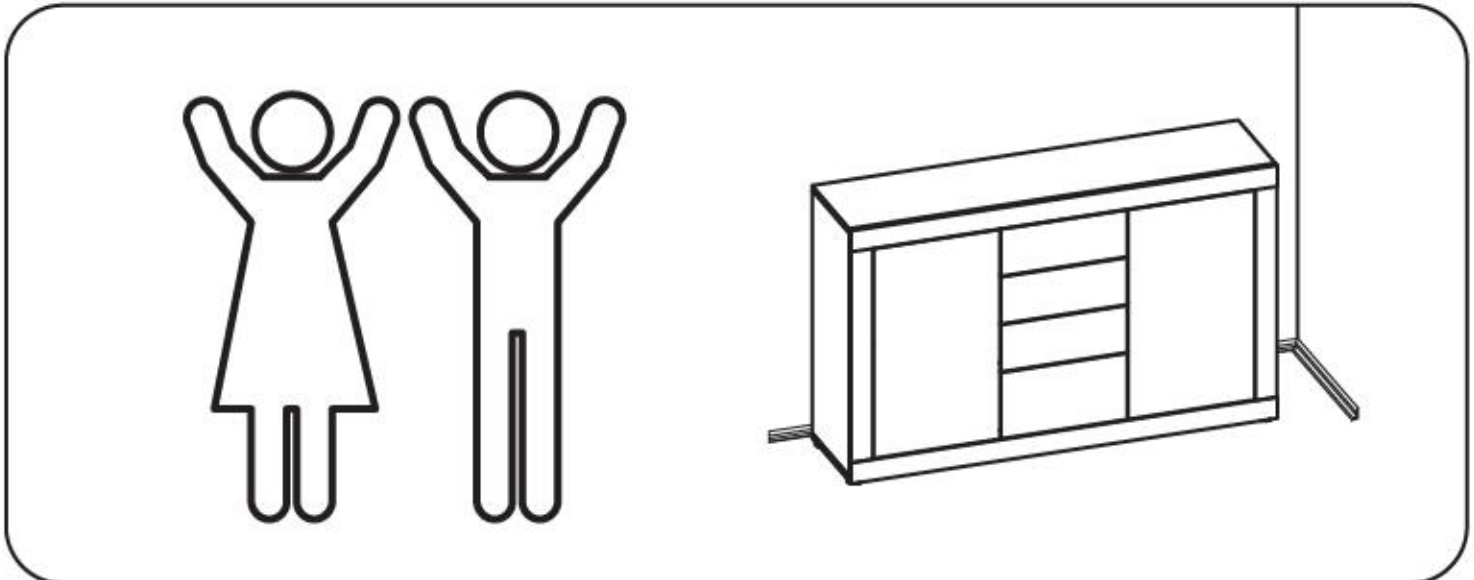
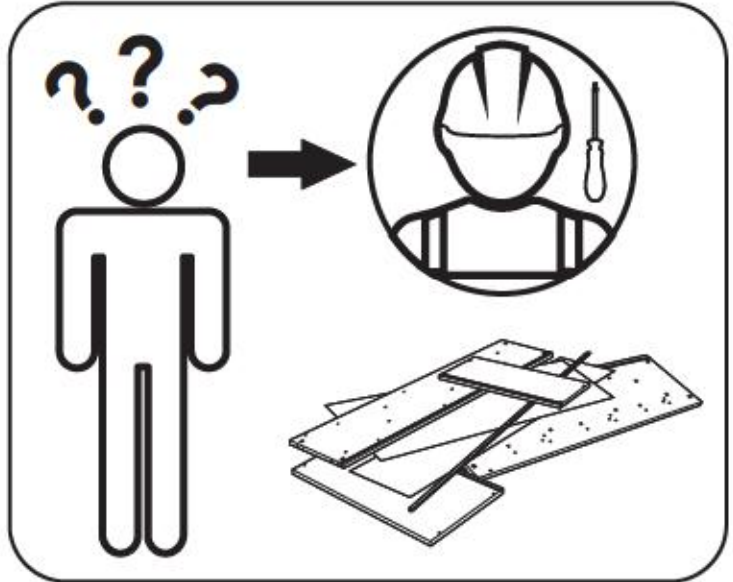
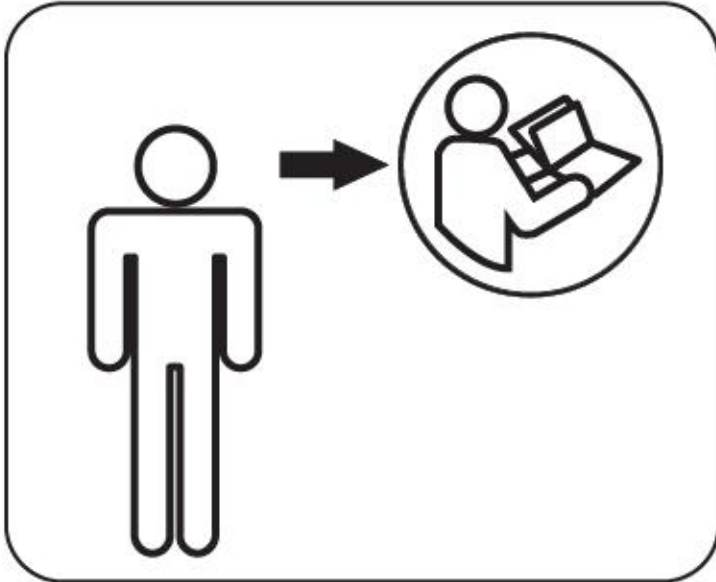
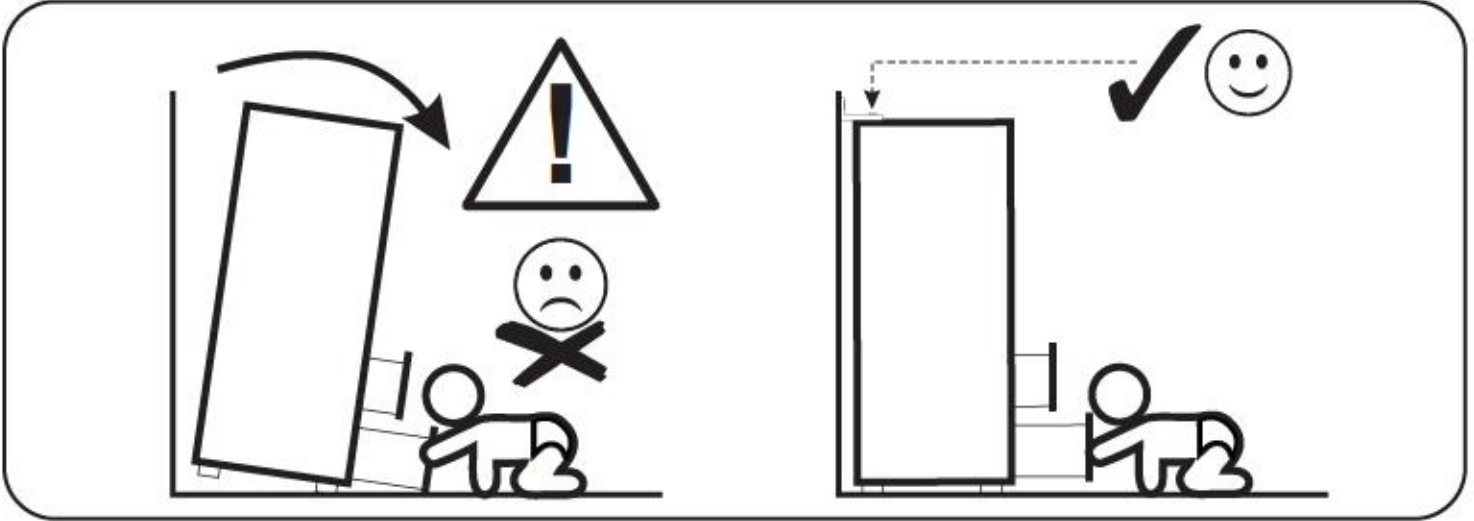
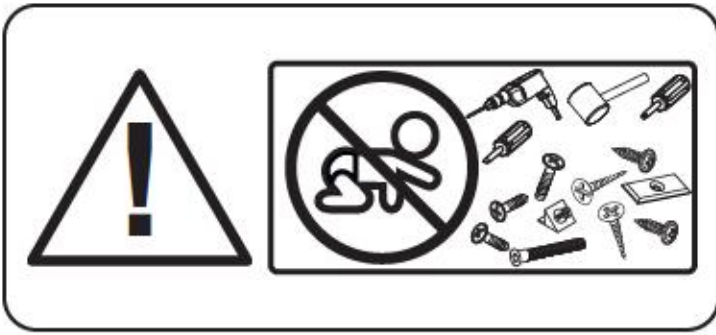



version A

BCxx

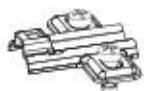

BCxx



version B

BCxx

+
BCxx

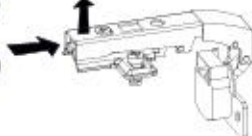

BCxx

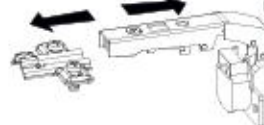

BCxx

245FCA24

MM

260

250

240

230

220

210

200

190

180

170

160

150

140

130

120

110

100

90

80

70

60

50













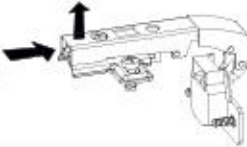



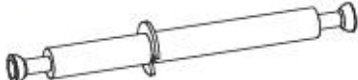

40

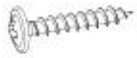
30

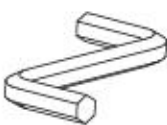
20

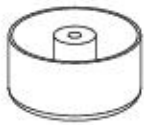
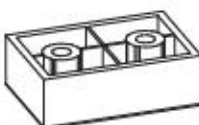
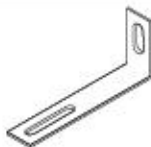
10

0

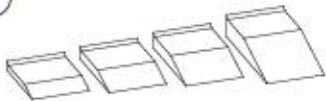
A1 8 x 35 mm x34 	A2 8 x 45 mm x4 	A3 8 x 60 mm x2 
BC17 + BC18 	C2 5 x 13 mm x22 	D2 
E0 Ø16 x28 	E1 15 x 12 mm x39 	F1 6 x 34 mm x27 
F3 7 x 64 mm x4 	F4 7 x 82 mm x2 	G1 7 x 50 mm x6 
I2 4 x 16 mm x20 	I3 3.5 x 22 mm x8 	I4 3.5 x 27 mm x1 
I11 4 x 27 mm x2 	M 	N1 3 x 16 mm x20 
O1 	O3 	Q9 
R1 	R3 	R4 
Z 		

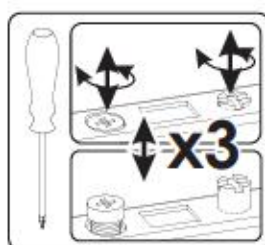
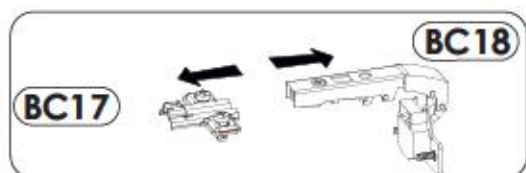

245FCA24

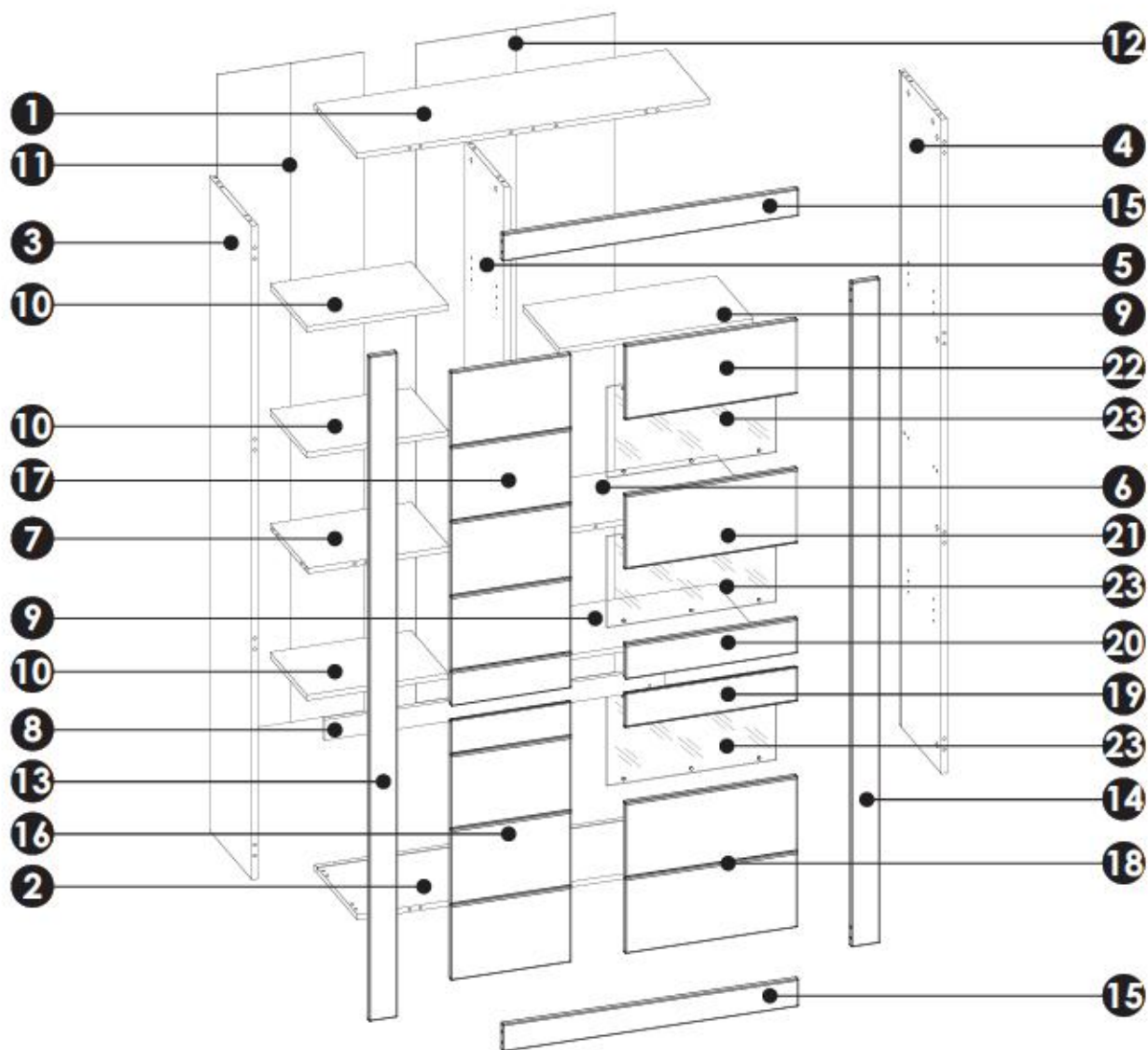
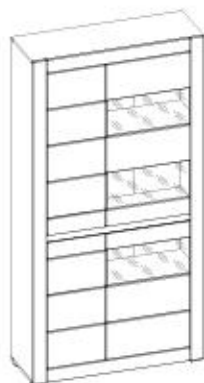

1	1000	334	16	x1	1/3
2	1000	334	16	x1	1/3
3	1925	334	16	x1	3/3
4	1925	334	16	x1	3/3
5	1925	314	16	x1	3/3
6	550	298	16	x1	1/3
7	401	298	16	x1	1/3
8	965	60	16	x1	2/3

9	550	298	16	x2	1/3
10	401	298	16	x3	1/3
11	1939	416	3	x1	3/3
12	564	1939	3	x1	3/3
13	1957	80	16	x1	3/3
14	1957	80	16	x1	3/3
15	840	80	16	x2	2/3
16	341	767	16	x1	2/3

17	341	983	16	x1	2/3
18	490	444	16	x1	2/3
19	490	103	16	x1	2/3
20	490	103	16	x1	2/3
21	490	220	16	x1	2/3
22	490	220	16	x1	2/3
23	481	268	4	x3	1/3

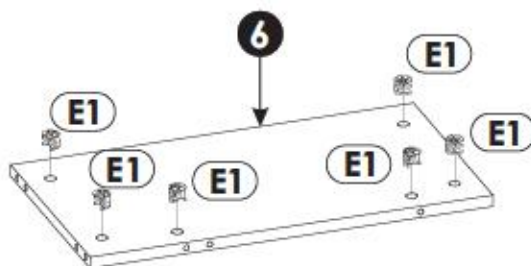
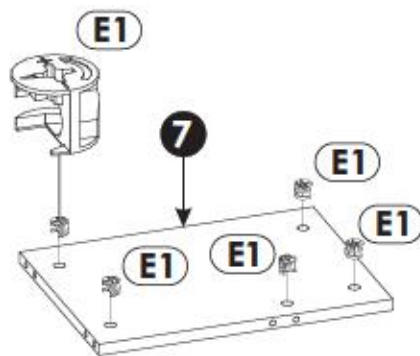
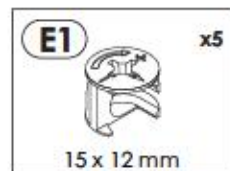
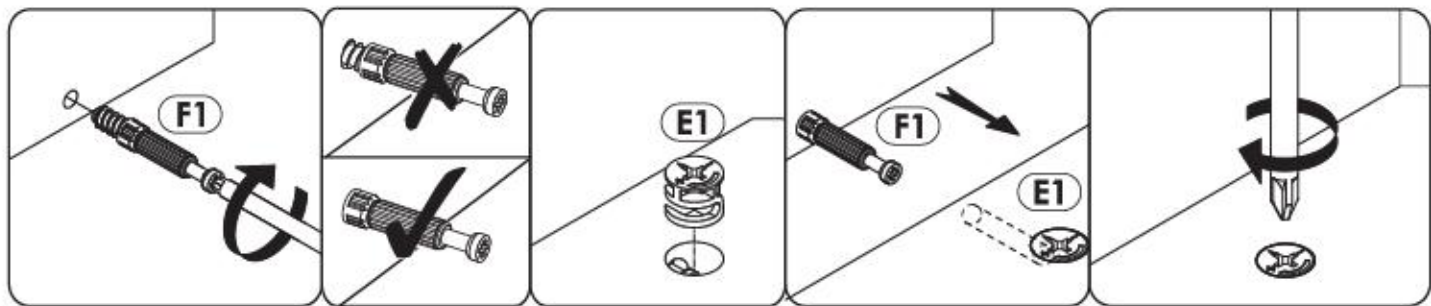

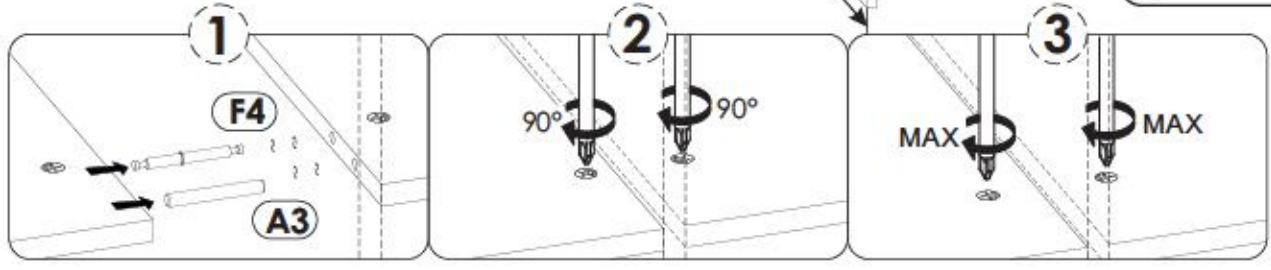
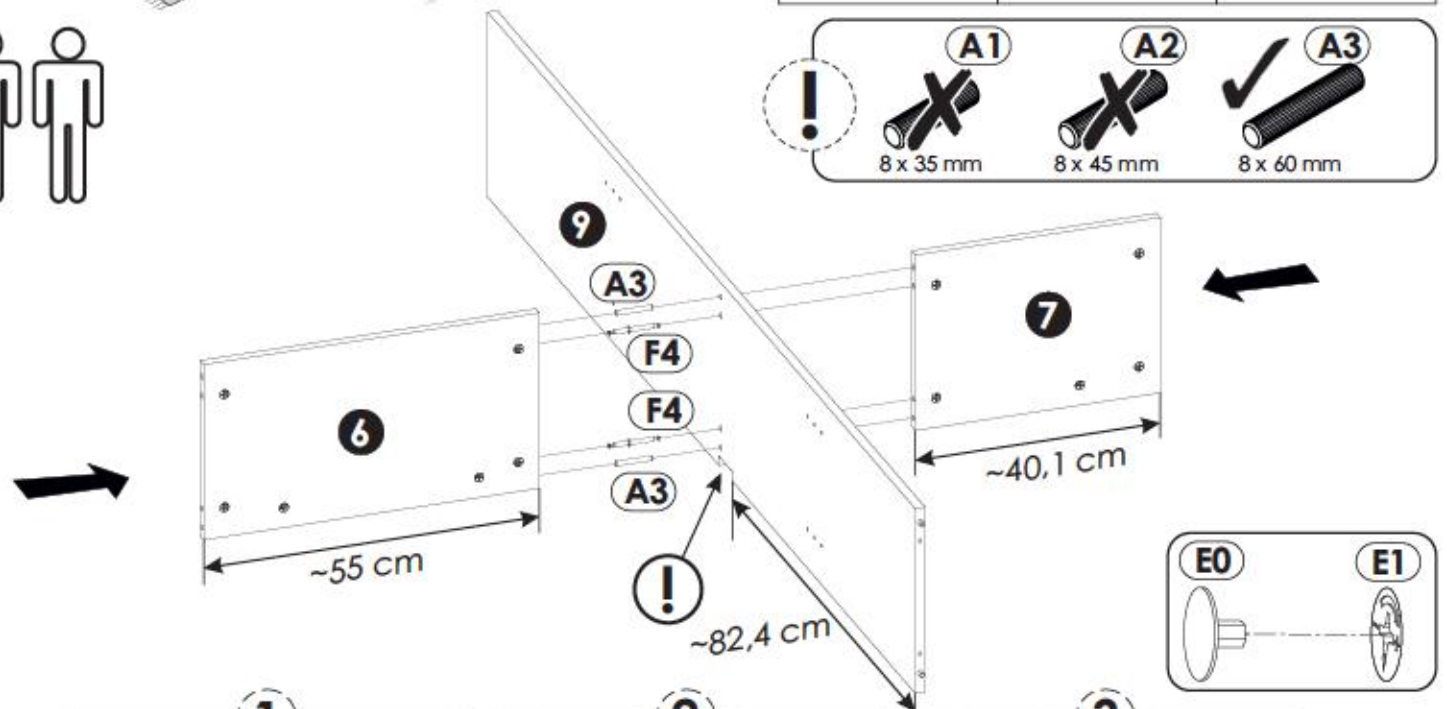
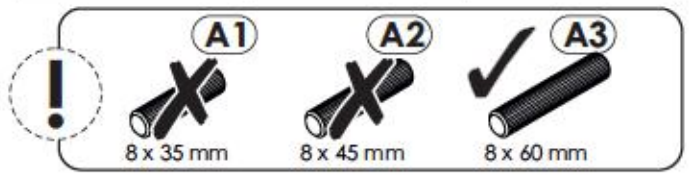
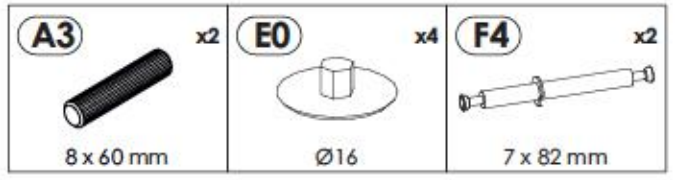
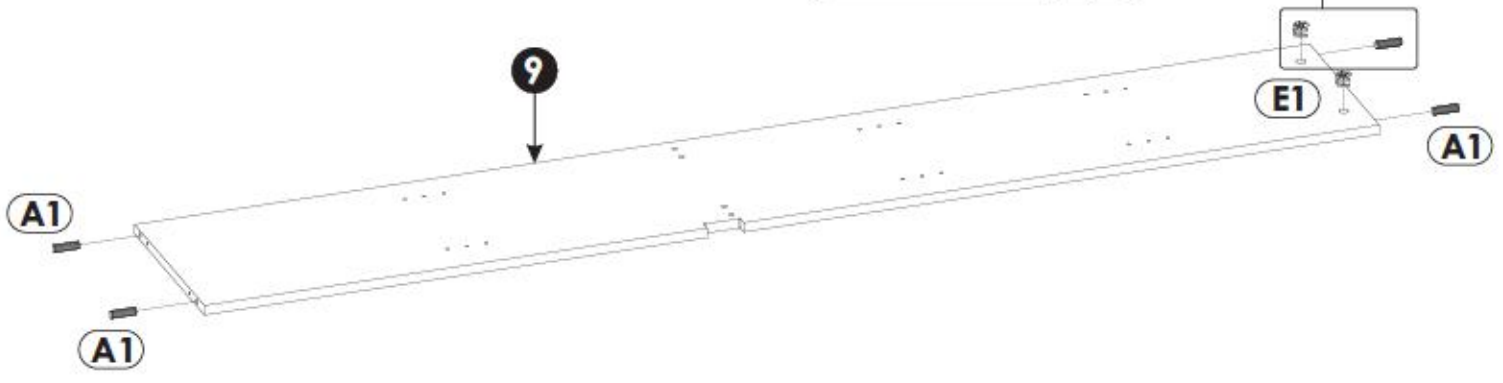
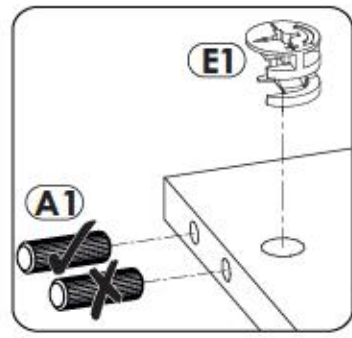
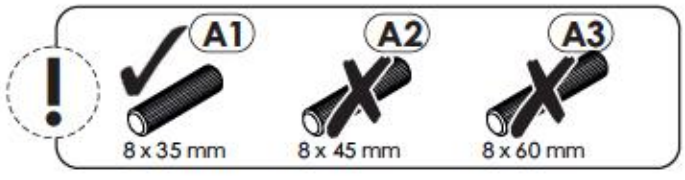
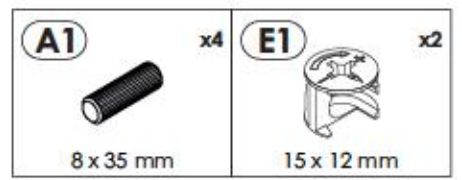

5 ▶

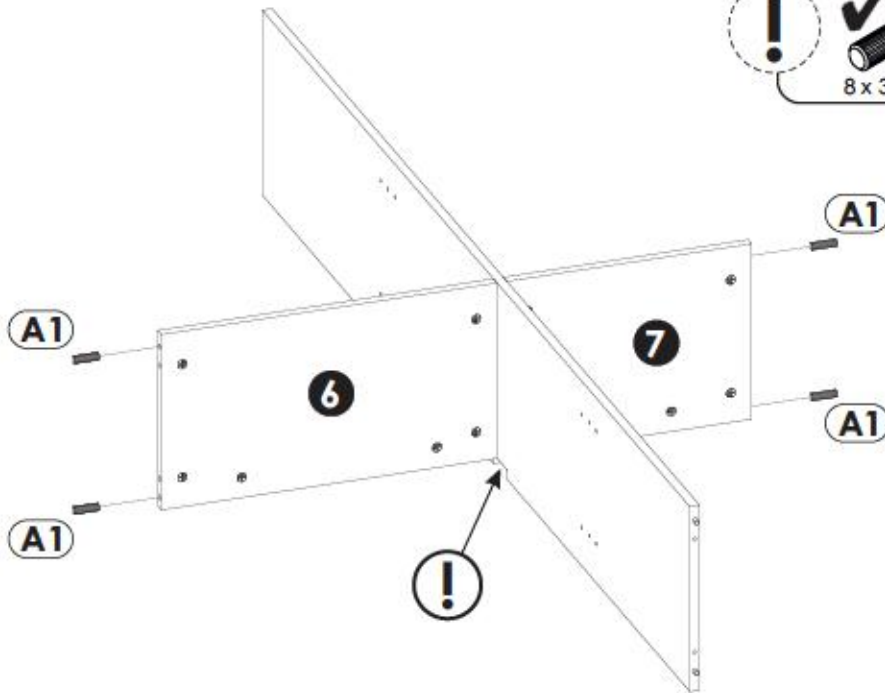
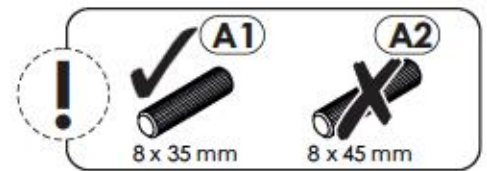
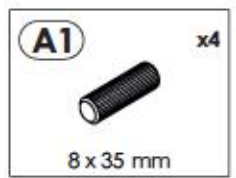
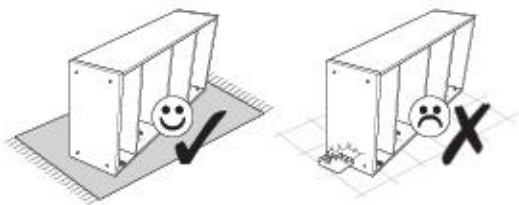

6 ▶

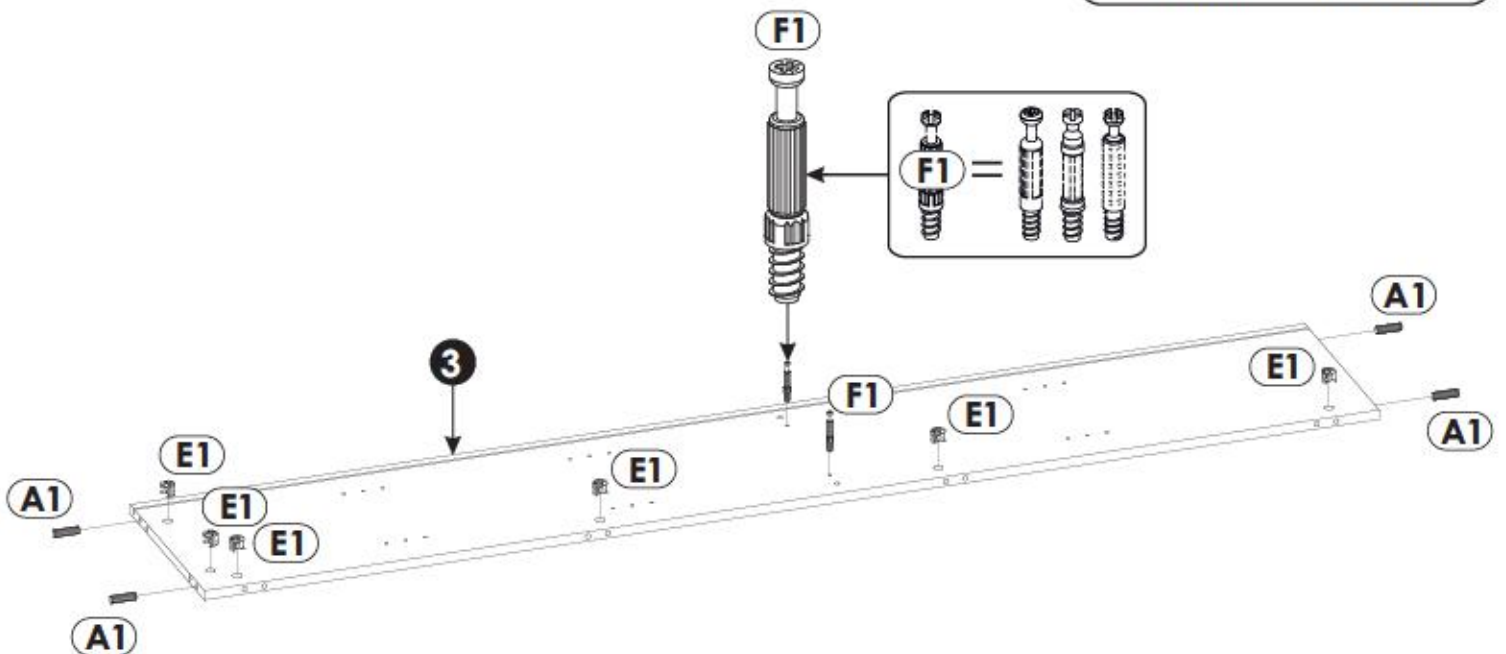
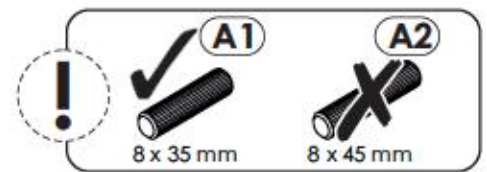

7 ▶

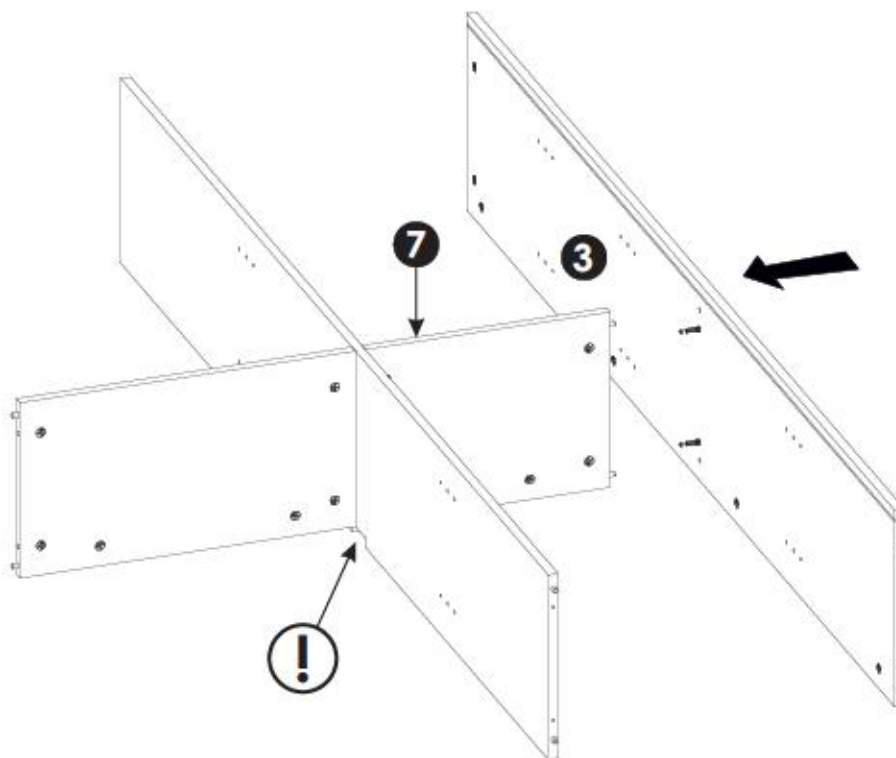
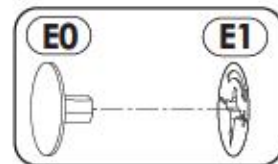
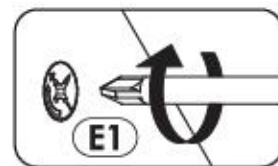
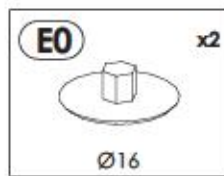
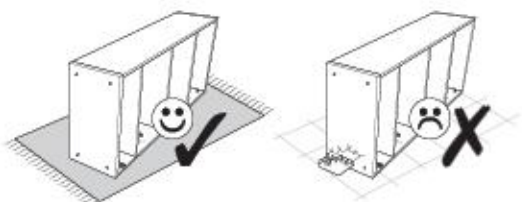

8 ▶

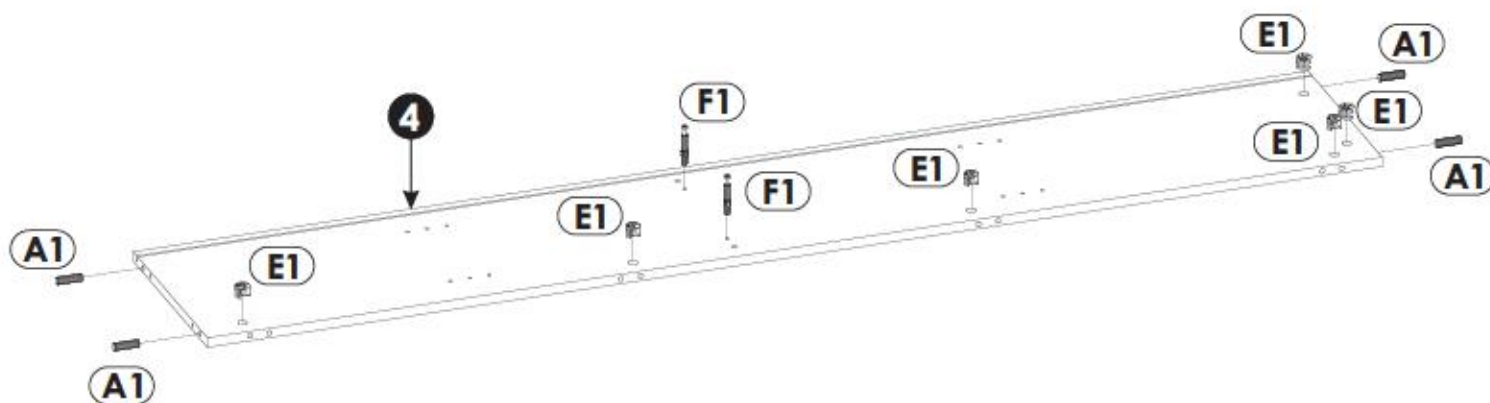
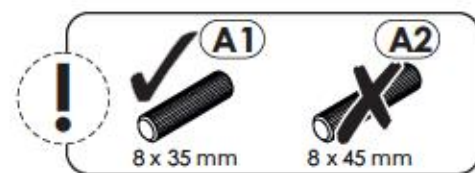
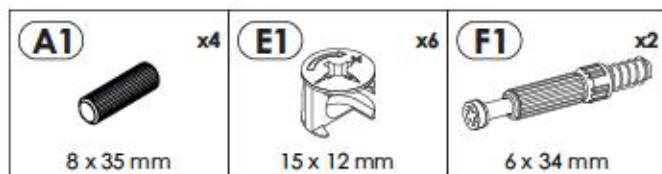

9 ▶

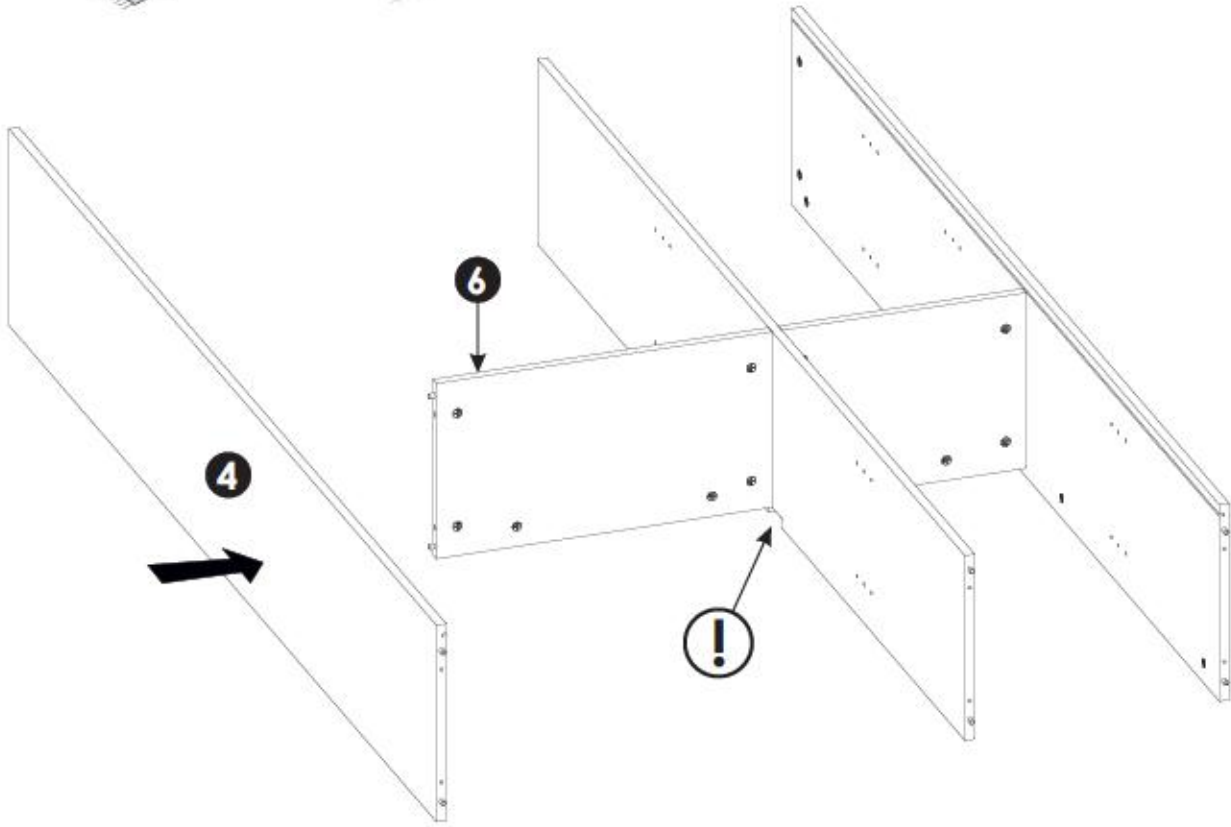
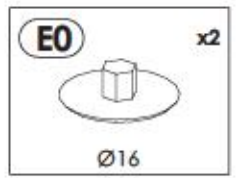
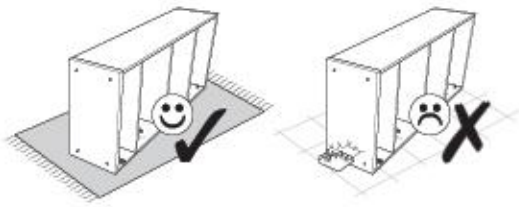

10 ▶

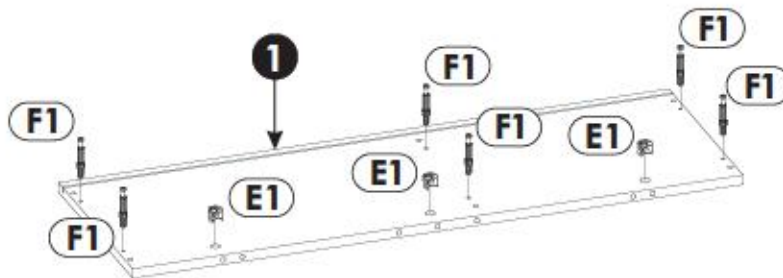
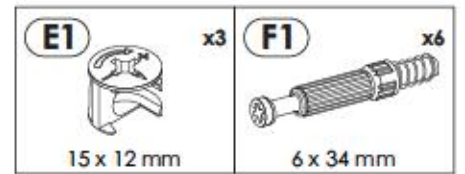

11 ▶

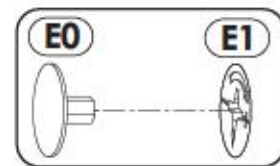
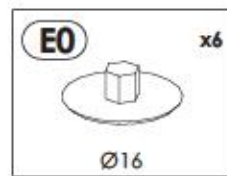
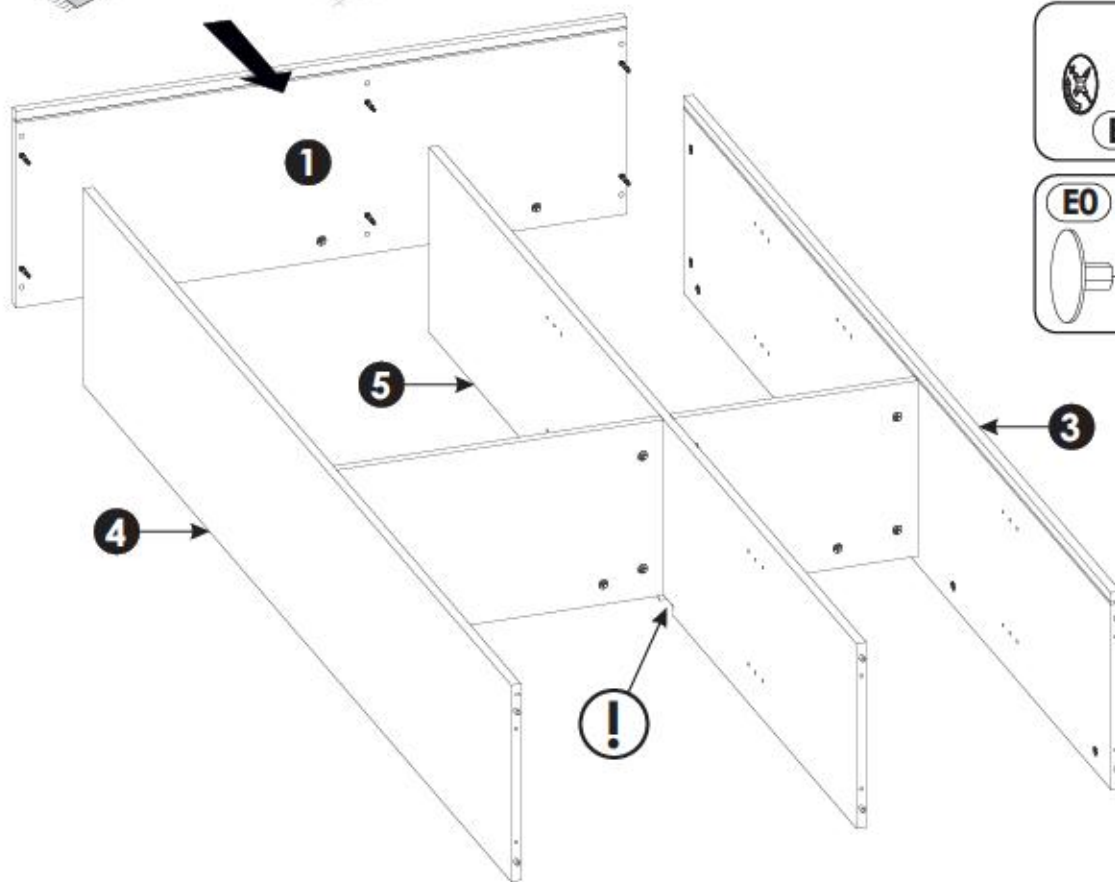

12 ▶

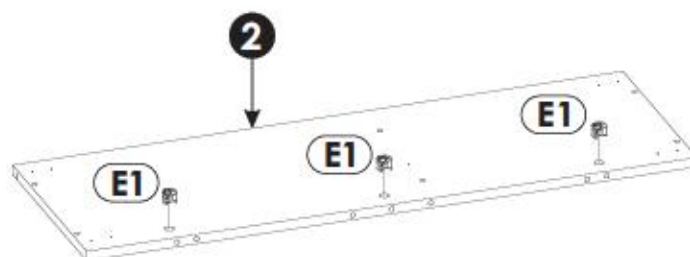

13▶

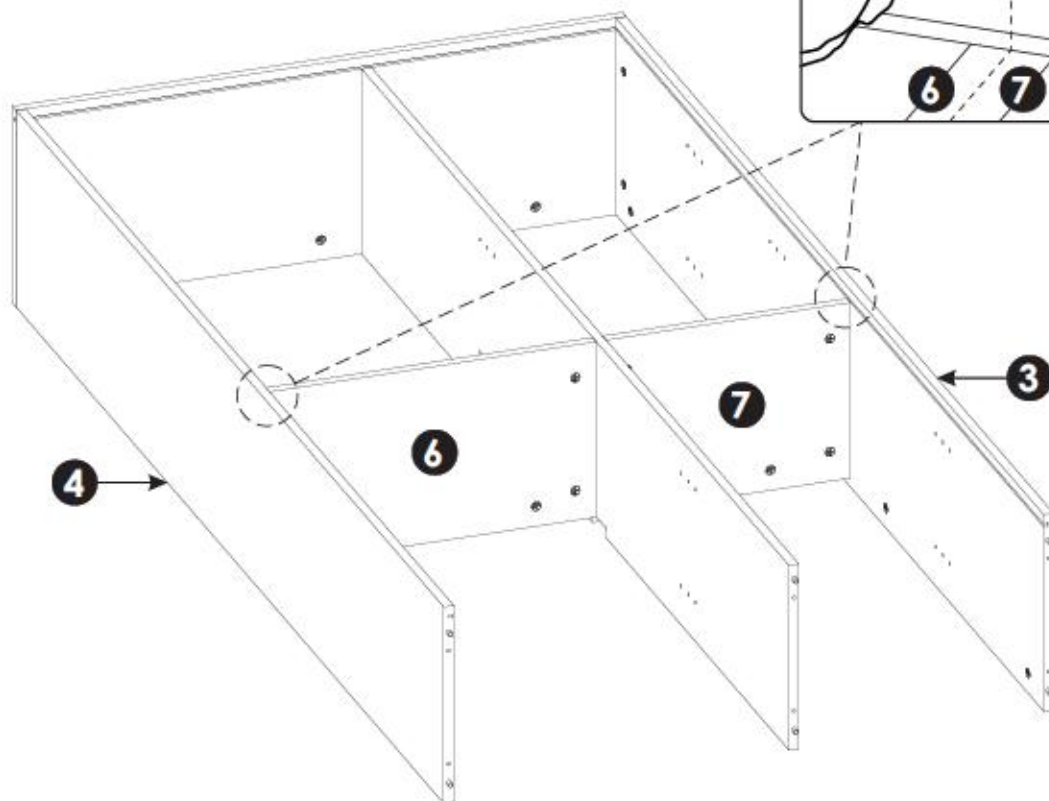
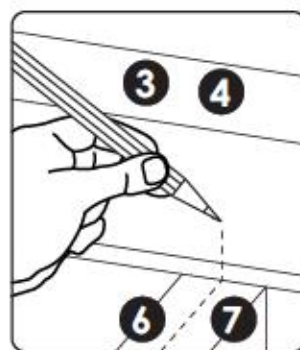
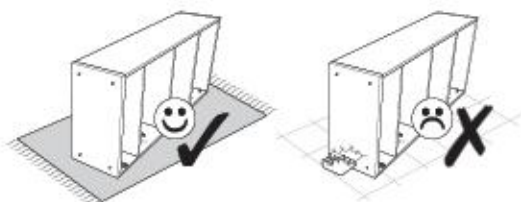

14▶

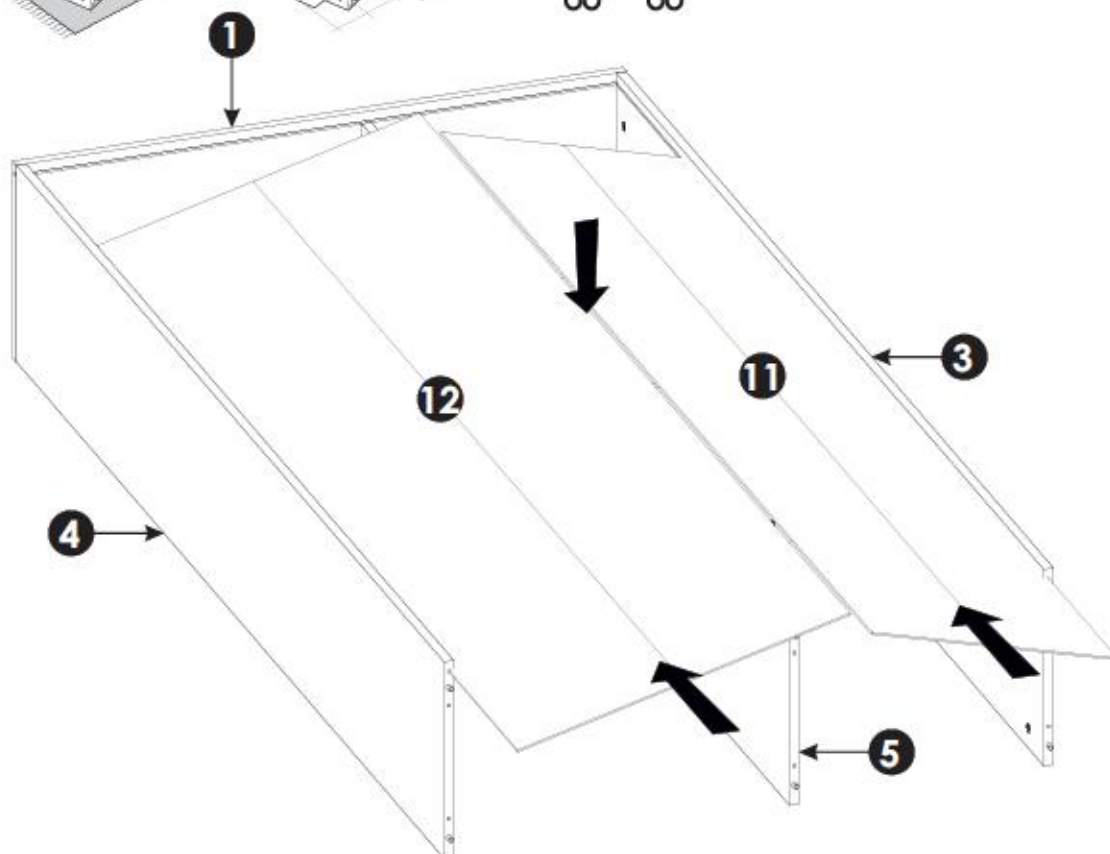

15▶

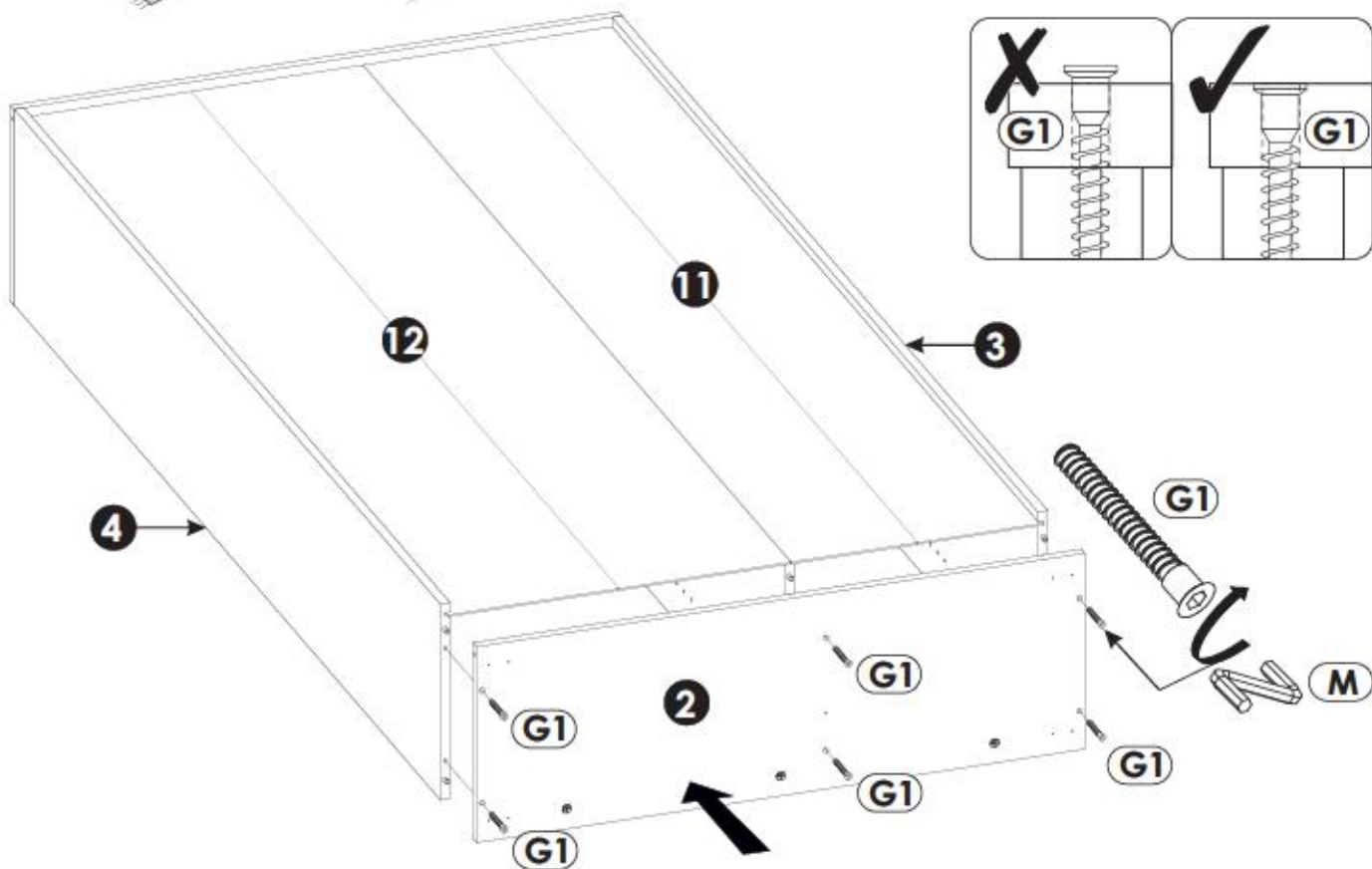
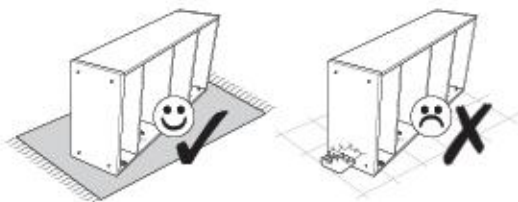

16▶

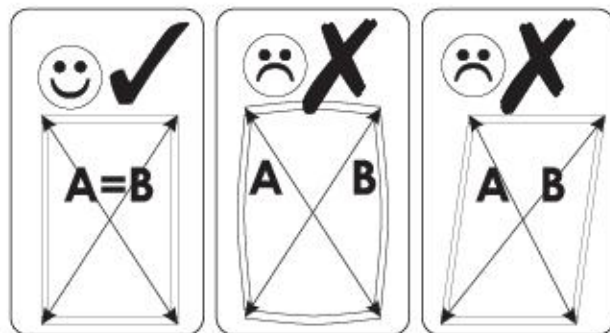
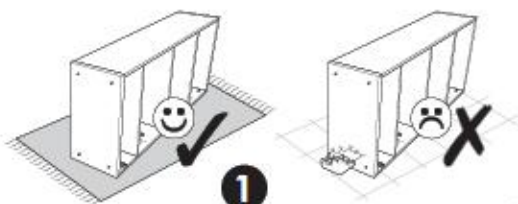

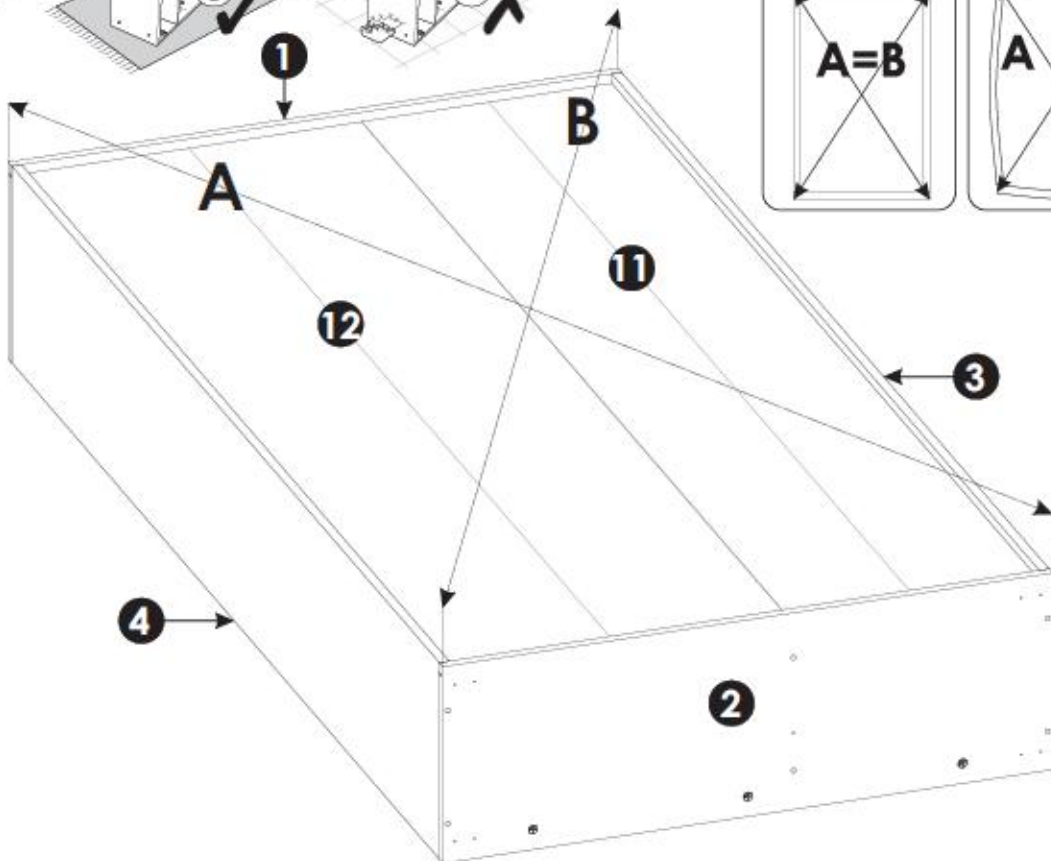

A=B

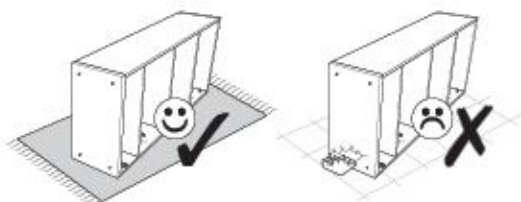

17▶



N1 x25  3 x 16 mm	R1 x13 	R4 x14 
---	--	--

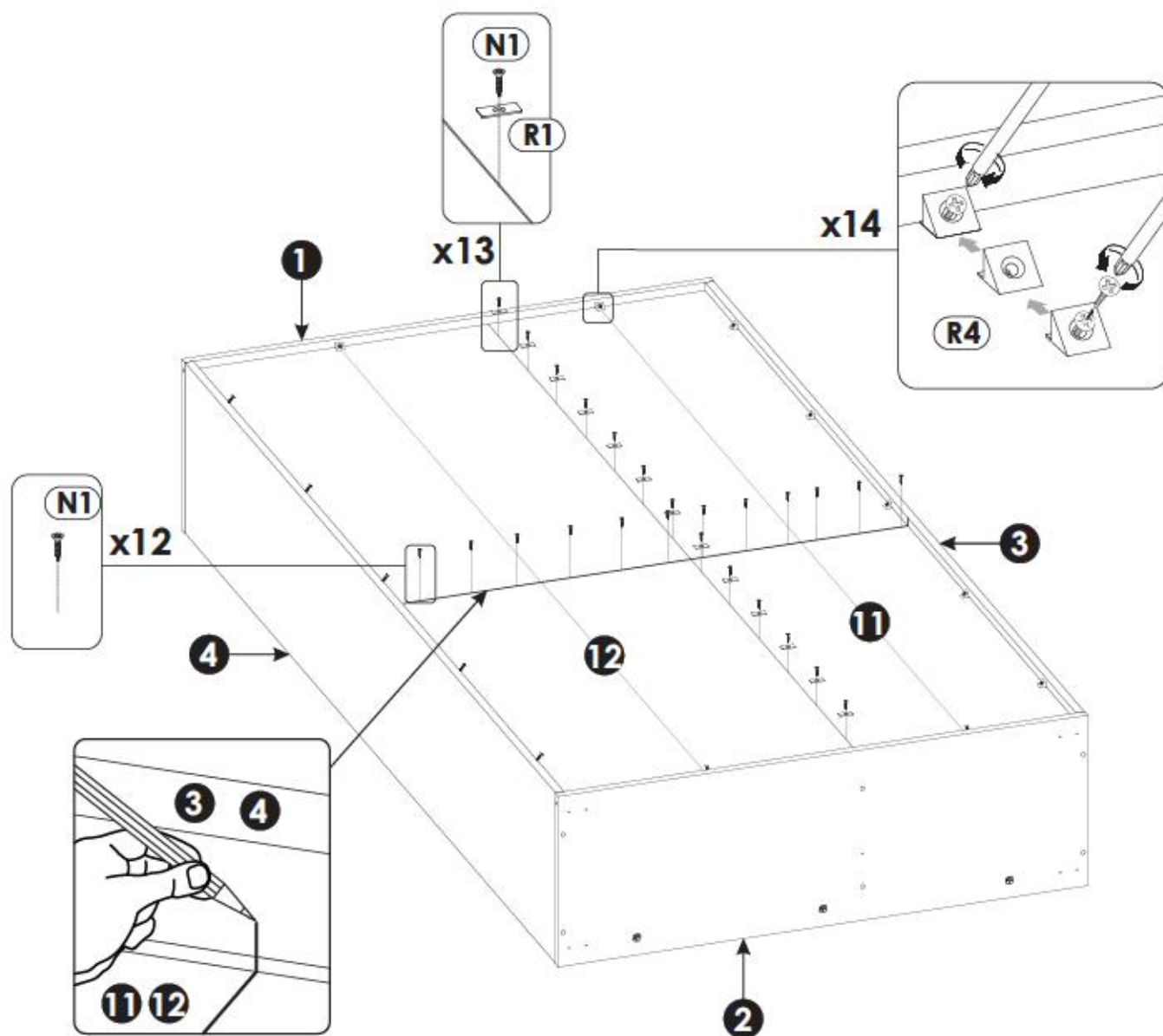

18▶

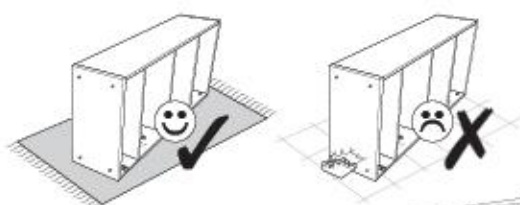

I3 x8 3,5 x 22 mm	I4 x1 3,5 x 27 mm
O1 x1	O3 x4

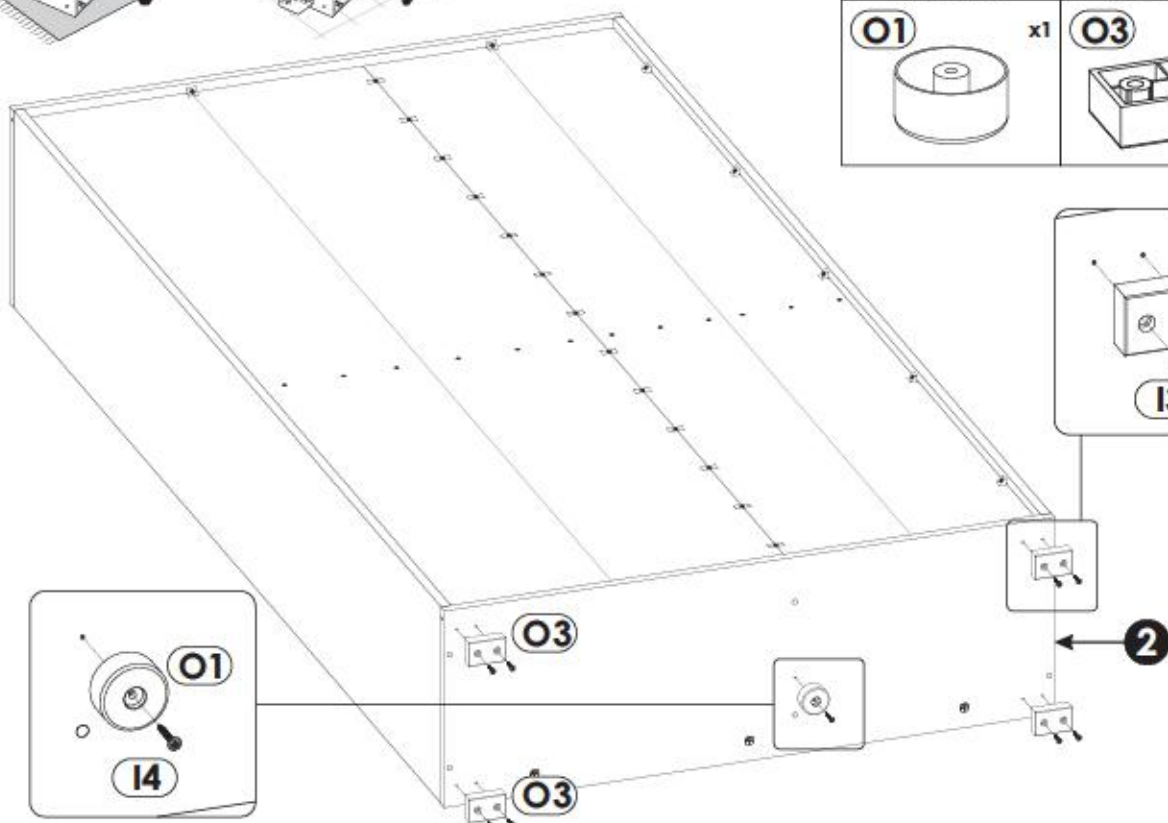

19▶



A1 x18 8 x 35 mm

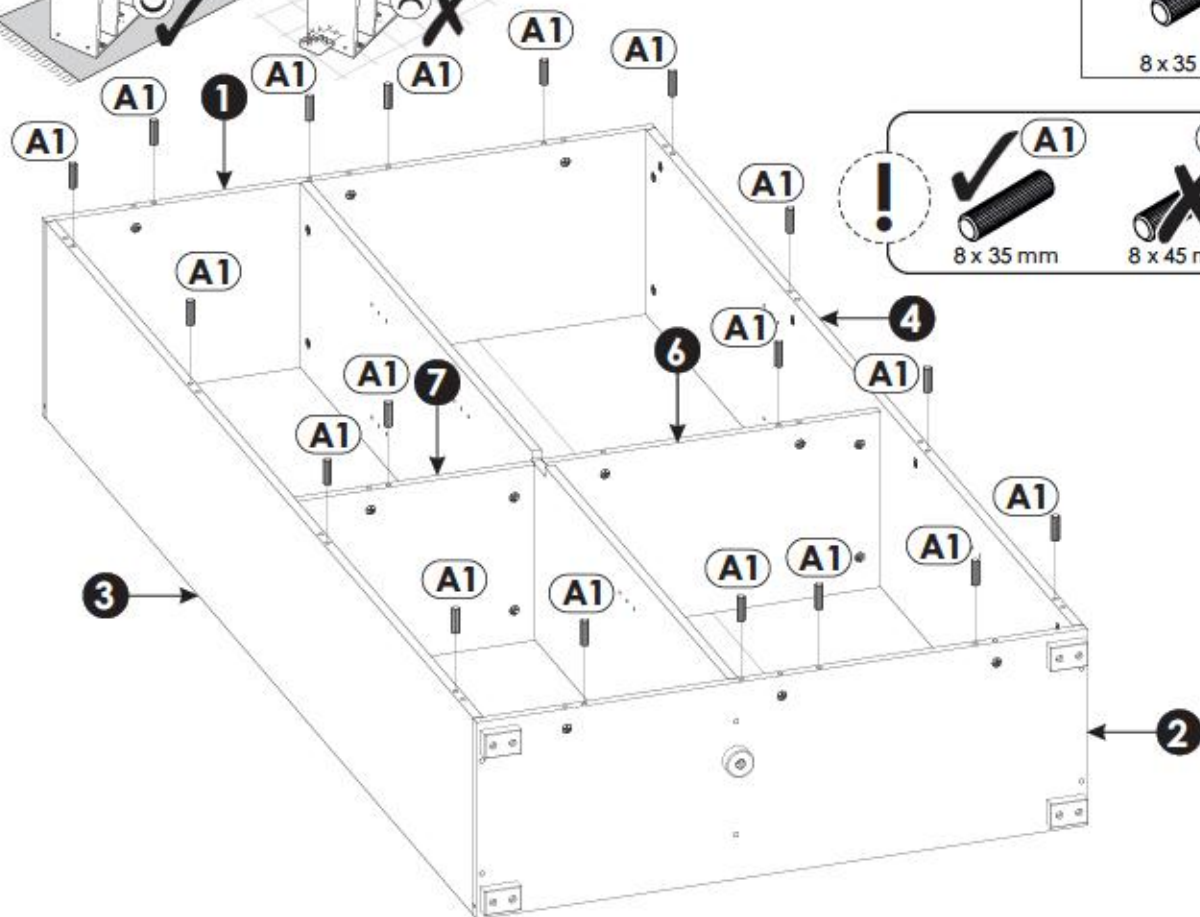
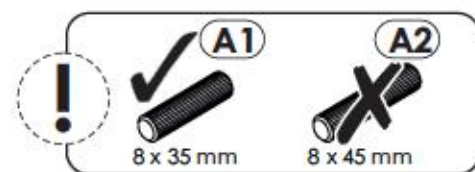

20▶

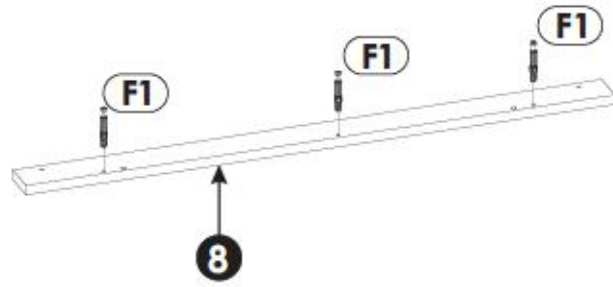
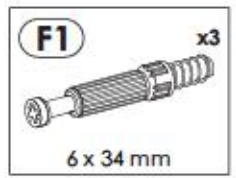
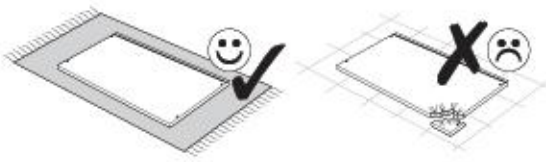

21▶

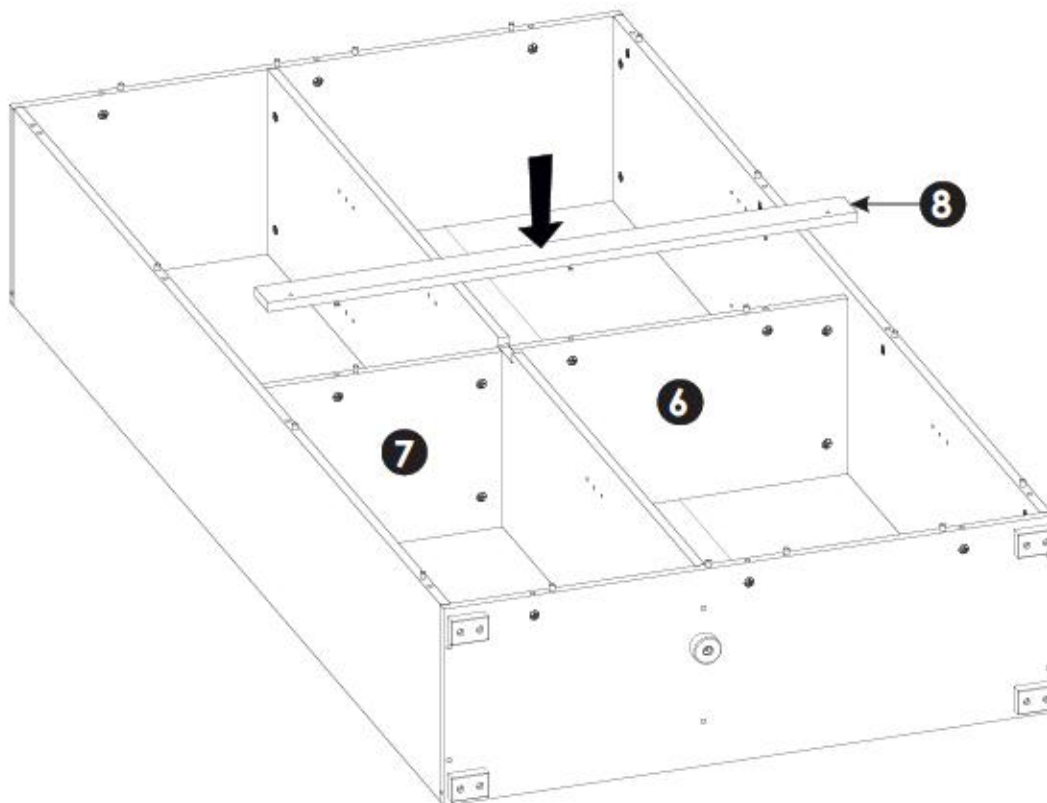
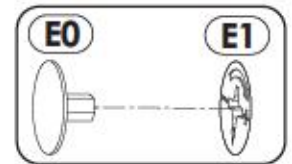
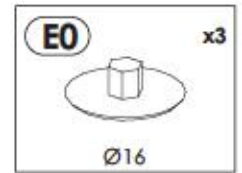
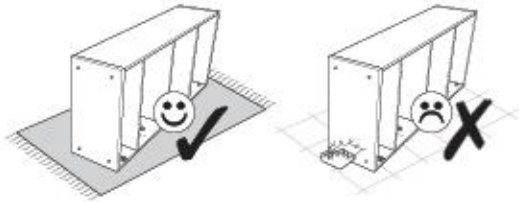

22▶

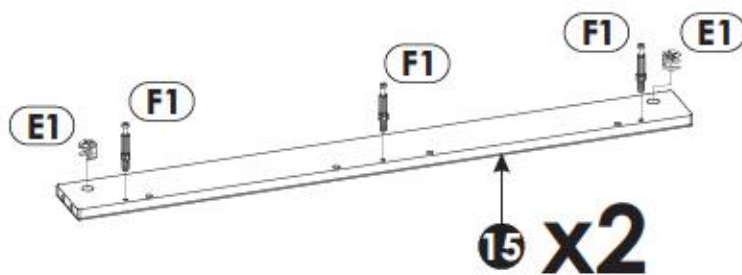
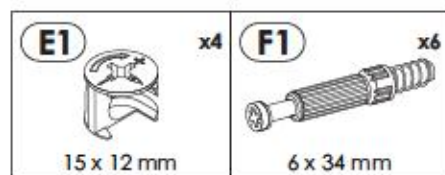

23▶

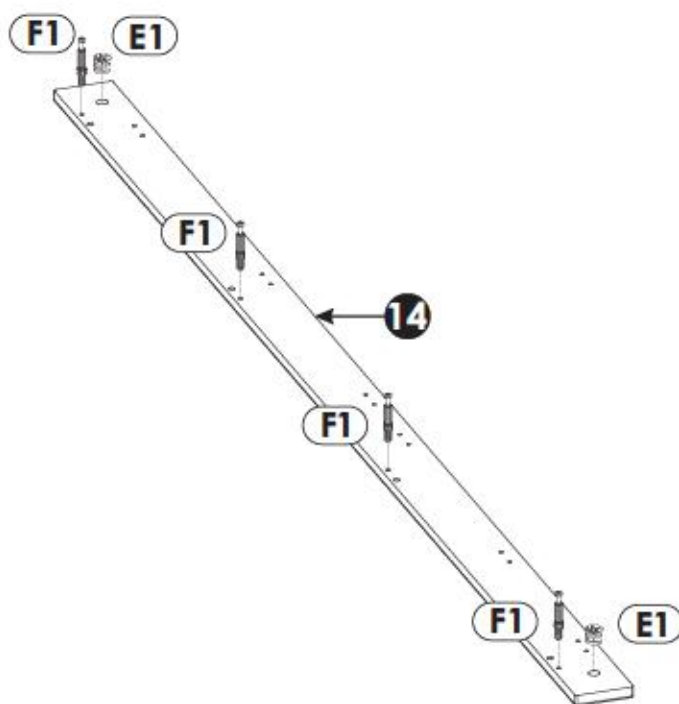
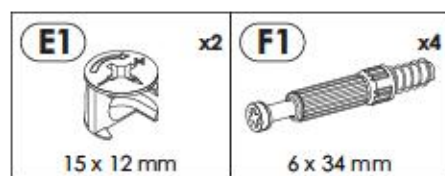

24▶

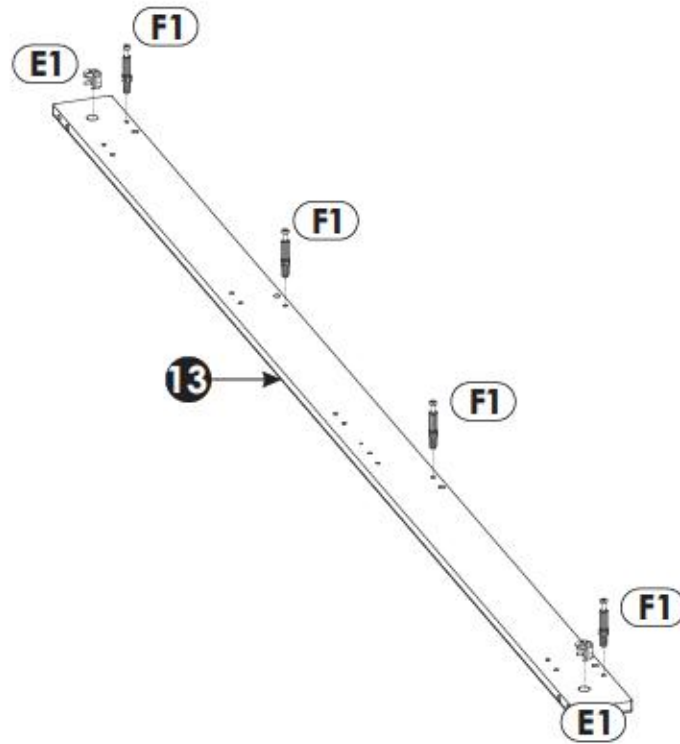
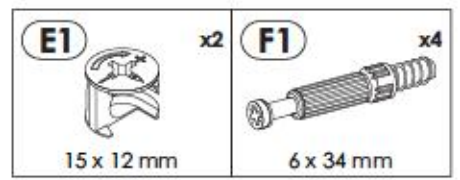

25▶

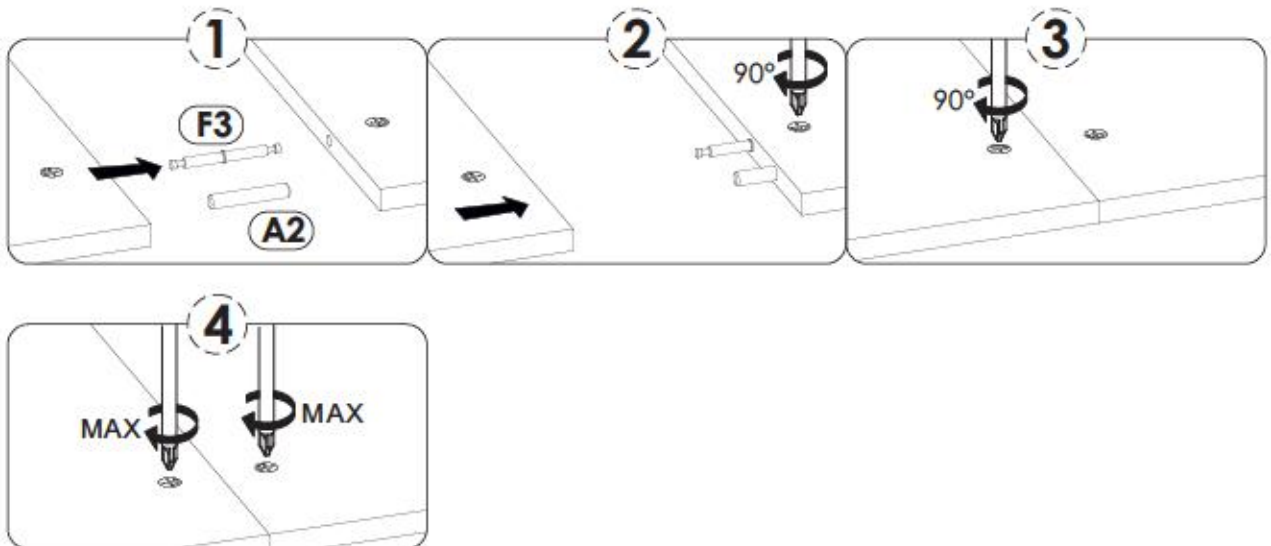
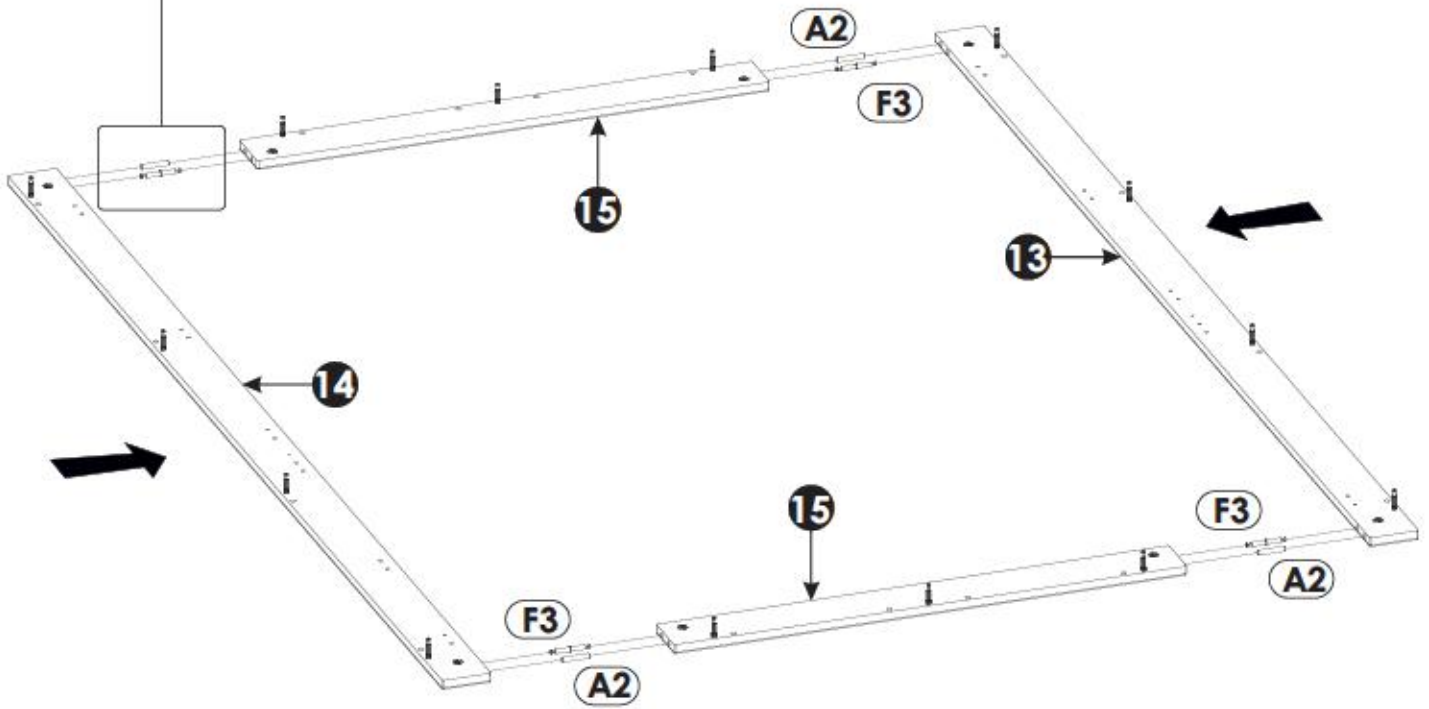
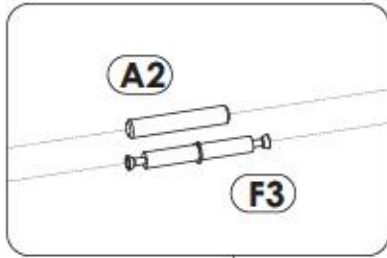
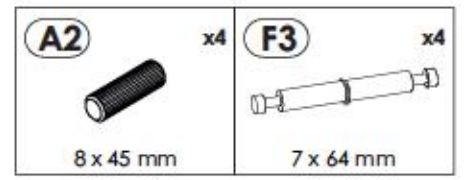
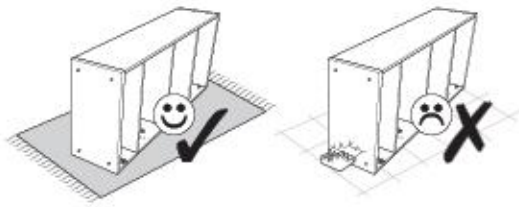

26 ▶

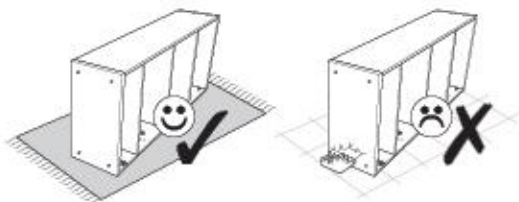

BC17 x11

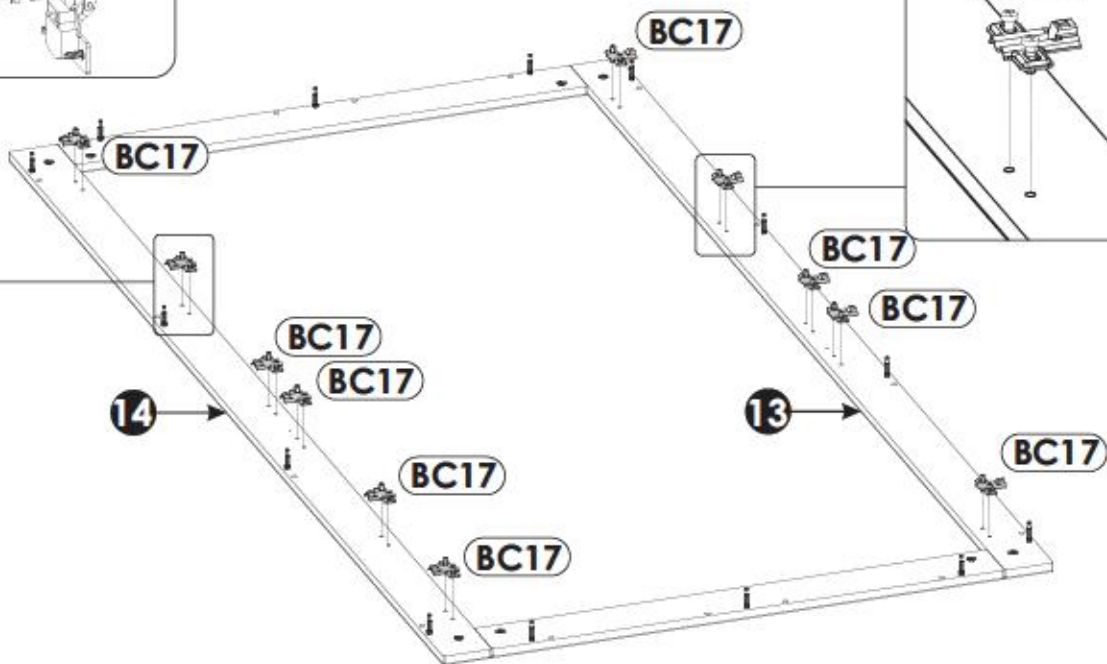
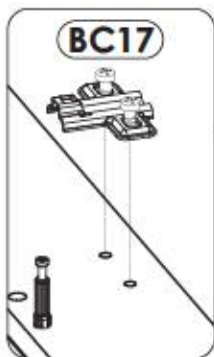
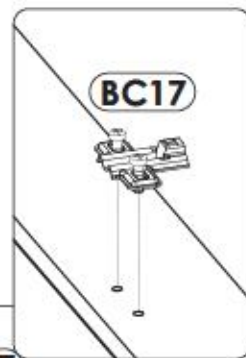
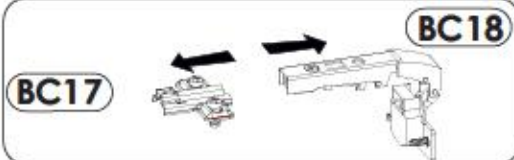

27 ▶

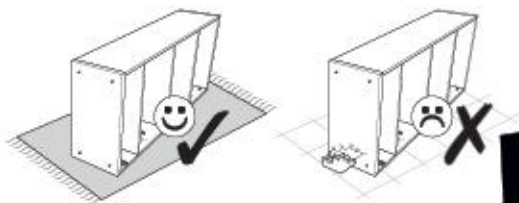

E0 x11



I11 x2

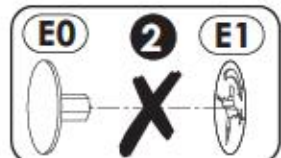
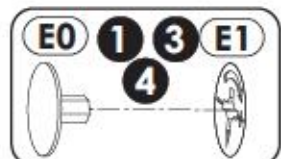
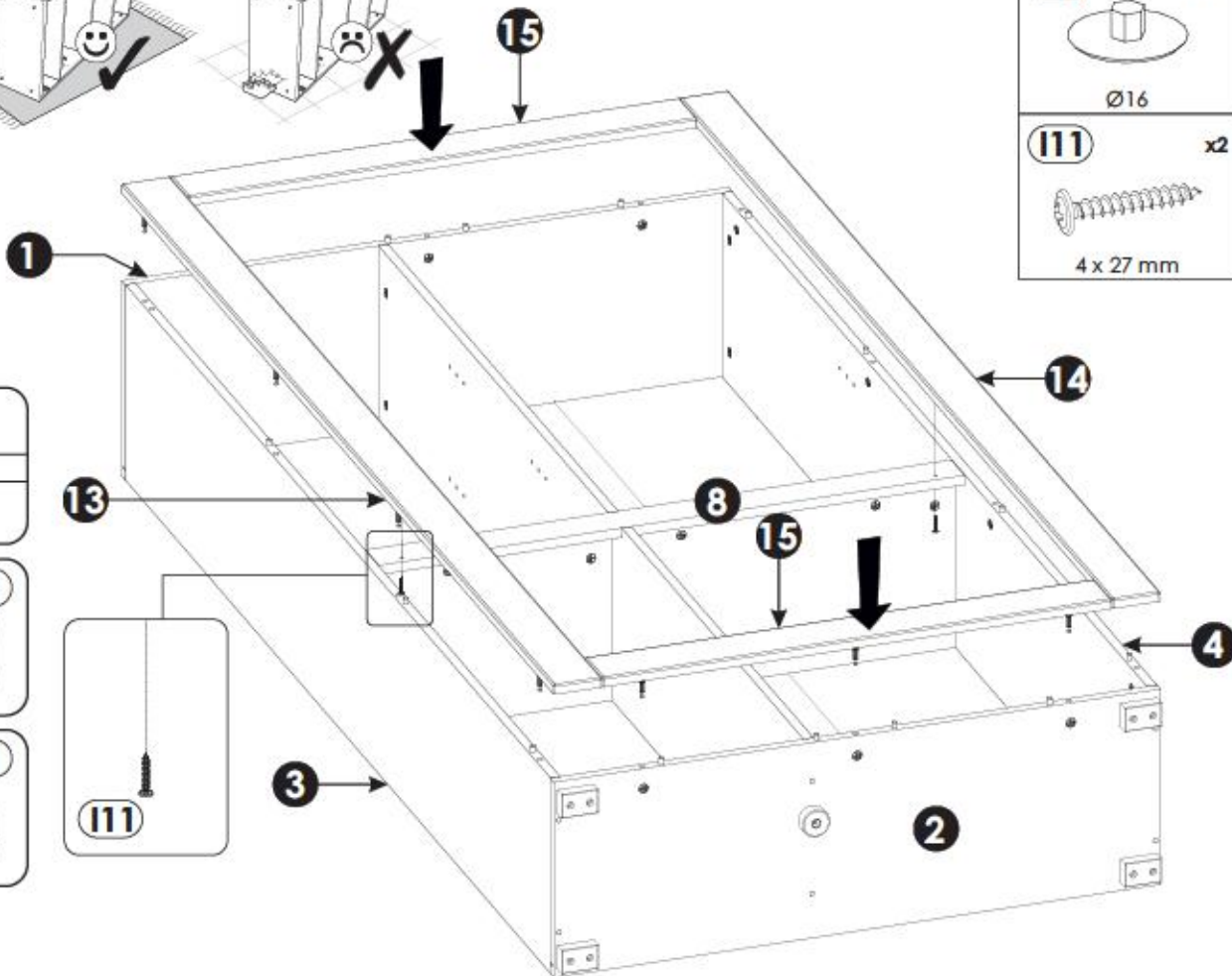
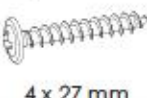

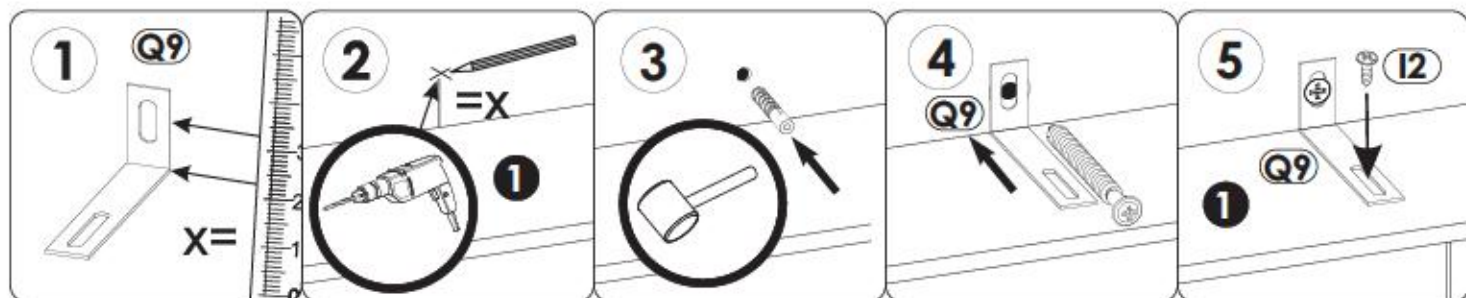
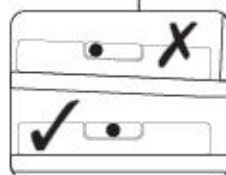
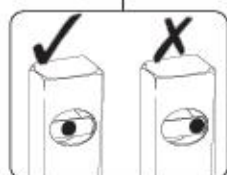
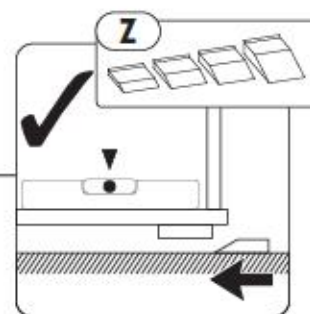
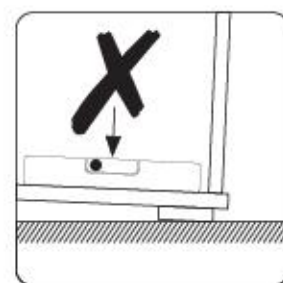
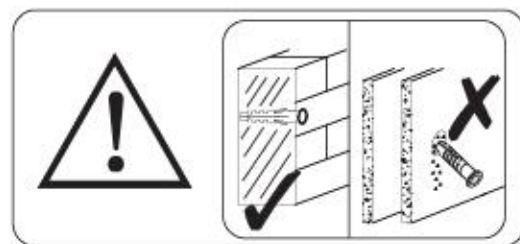
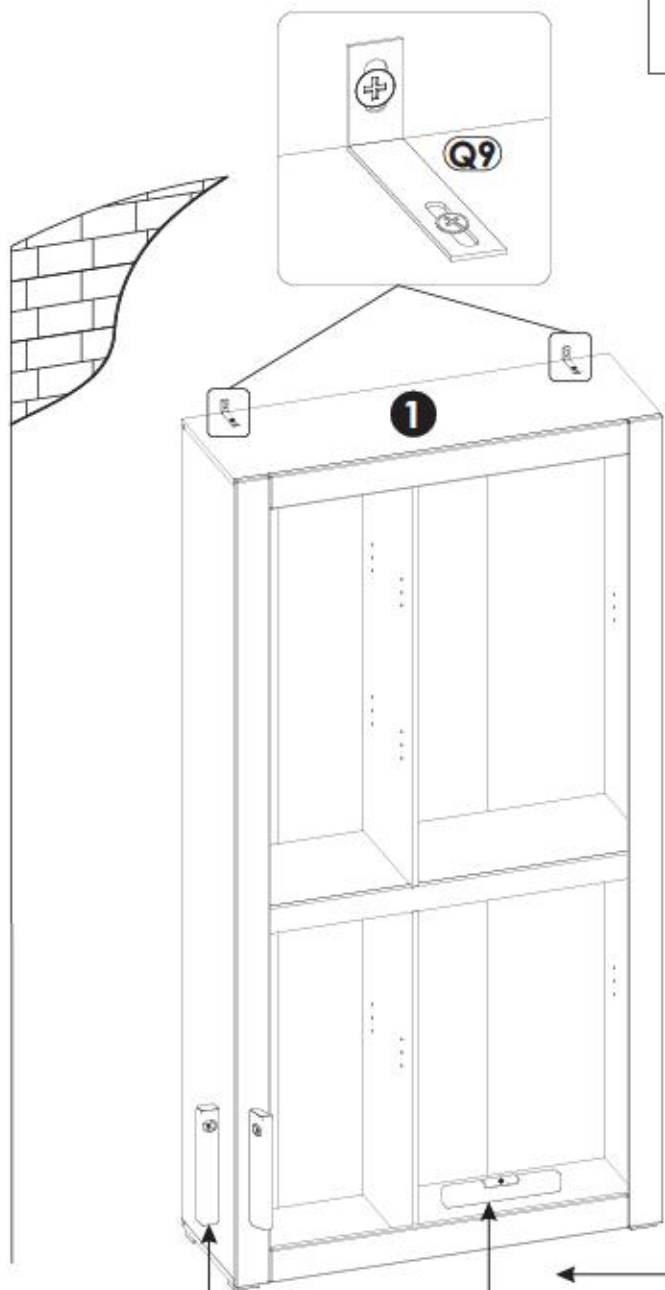

29▶

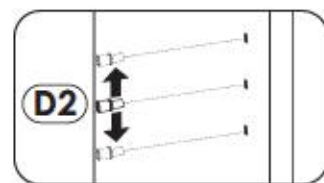
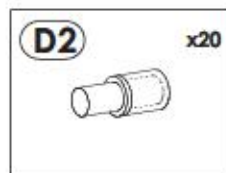
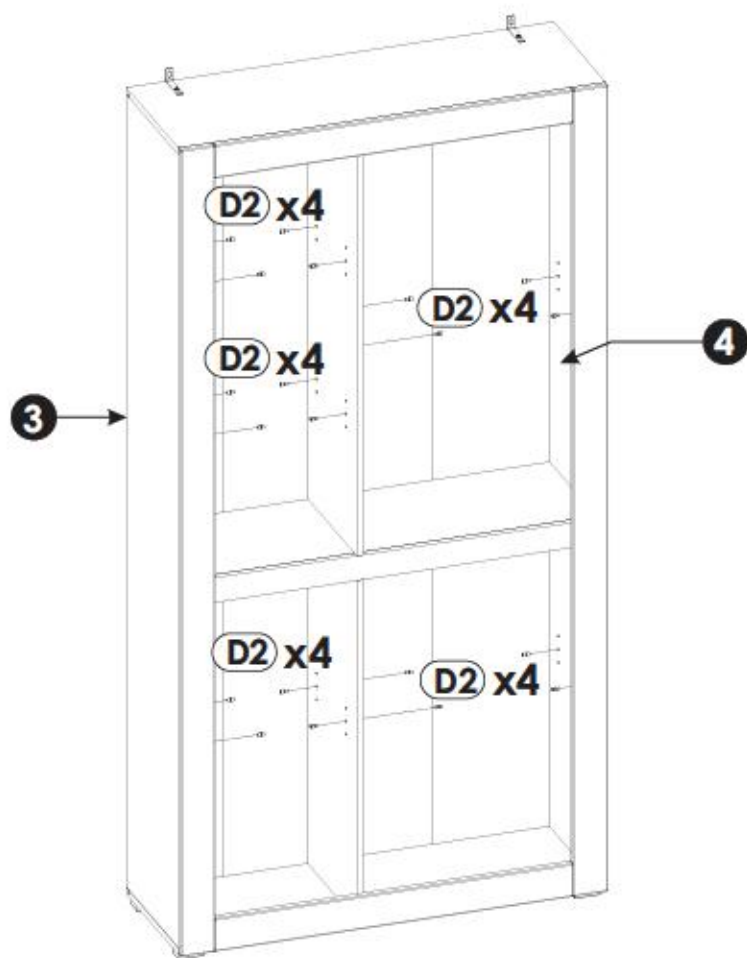

30▶

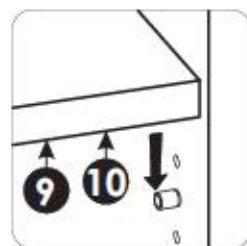
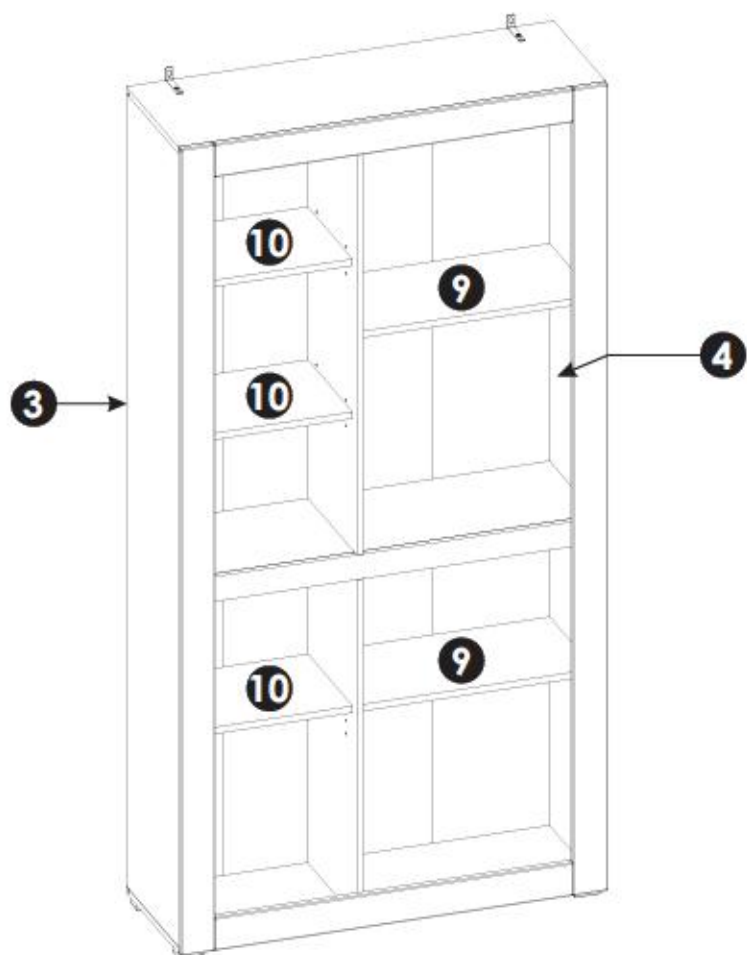

31▶

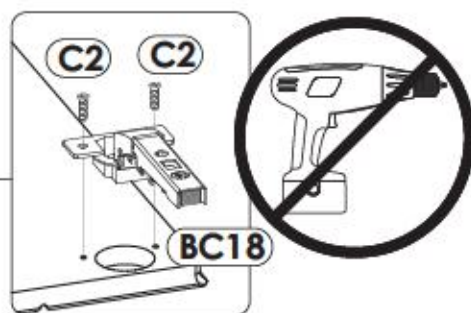
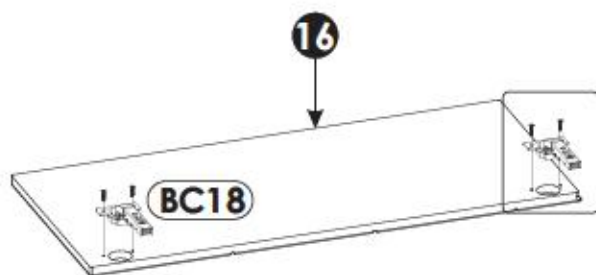
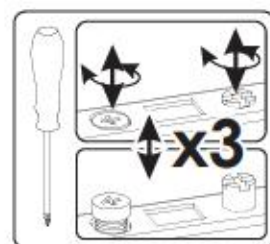
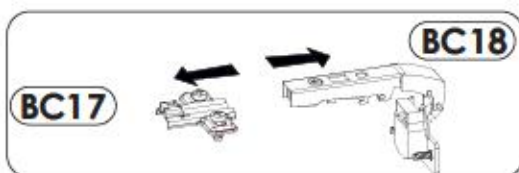
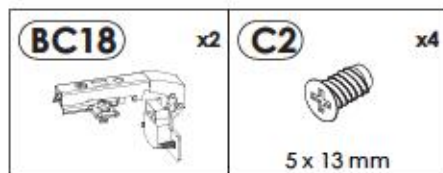

32▶

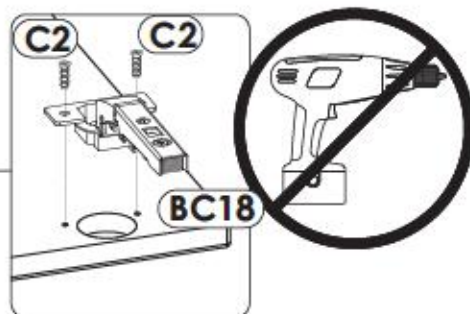
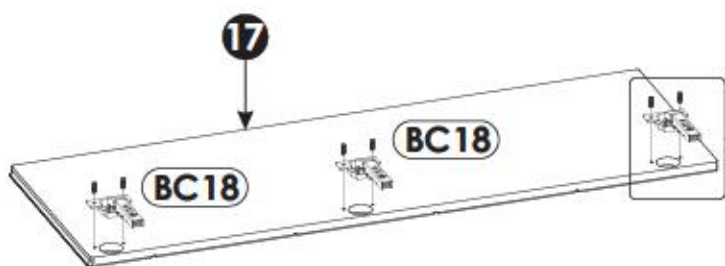
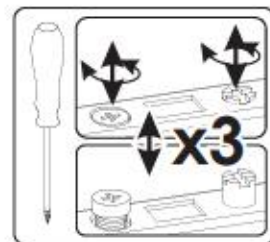
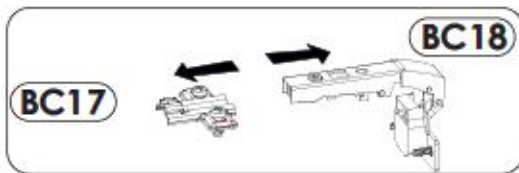
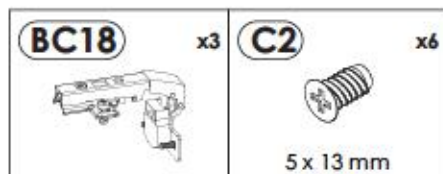

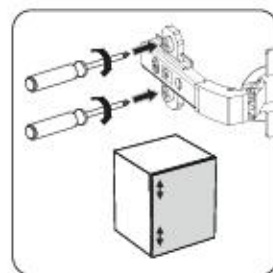
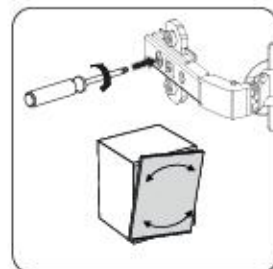
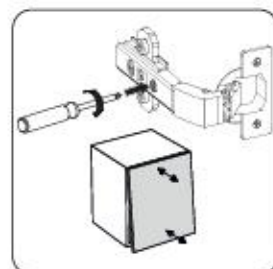
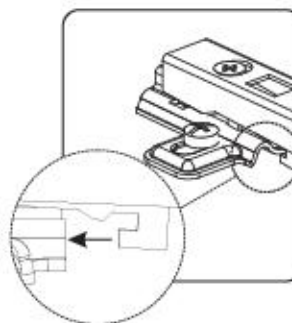
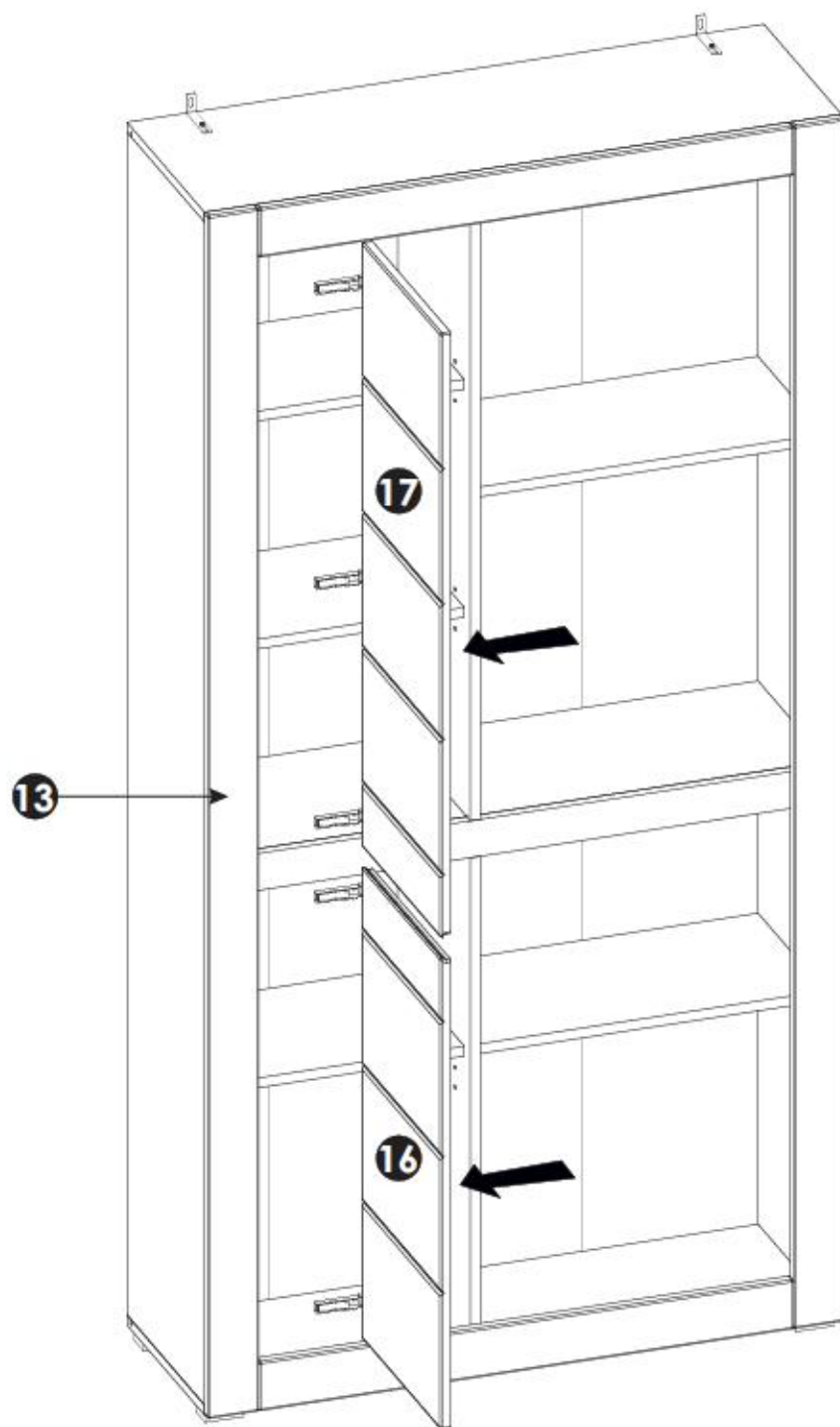

34▶

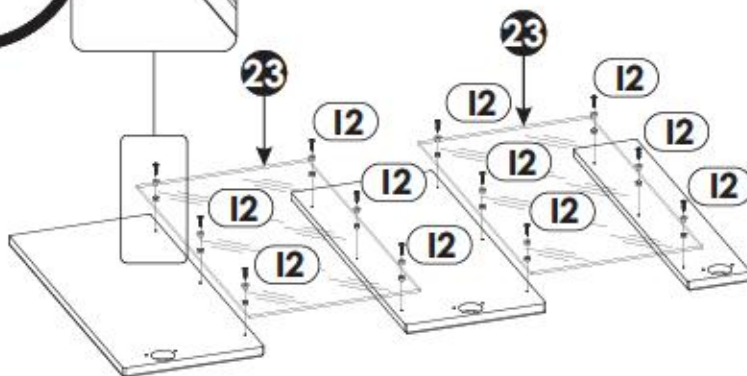
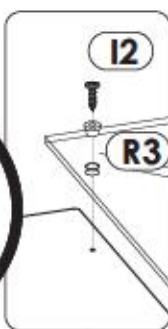
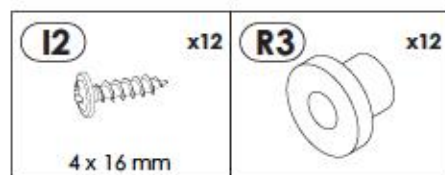
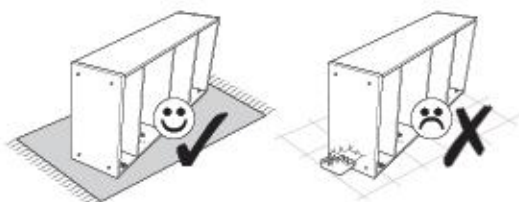

35▶

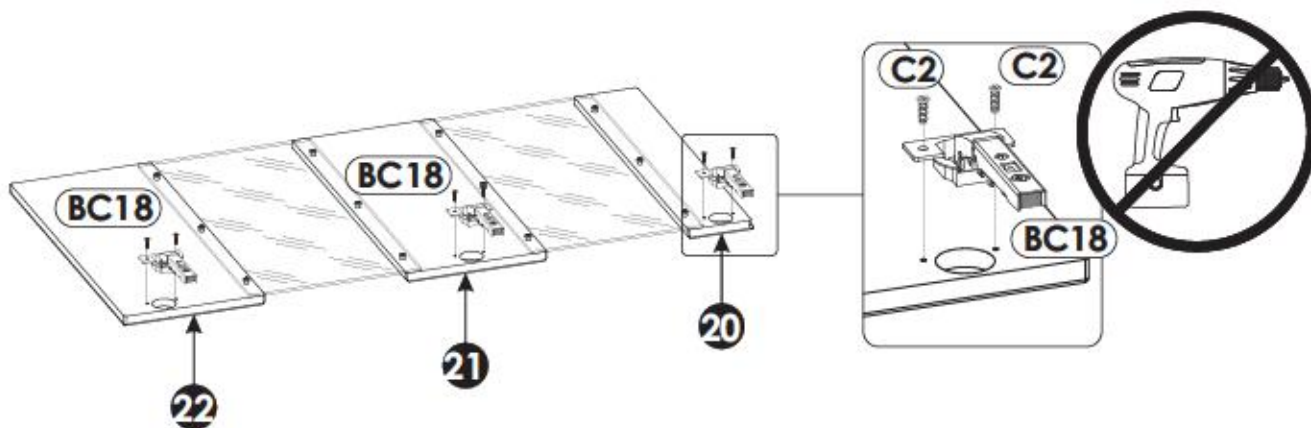
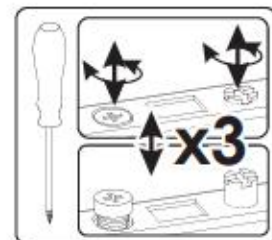
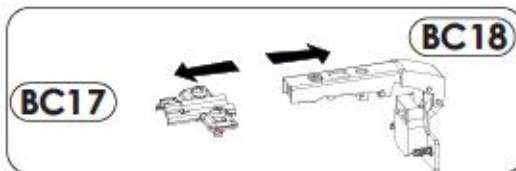
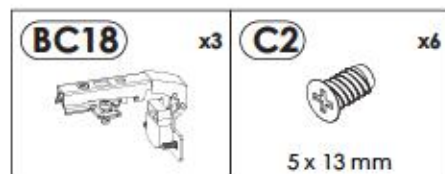
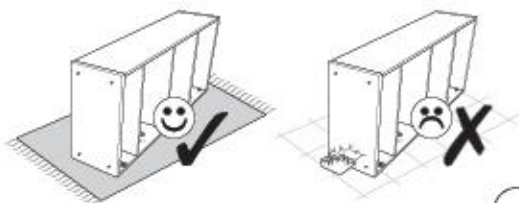

36 ▶

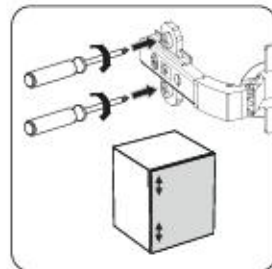
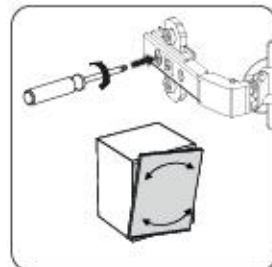
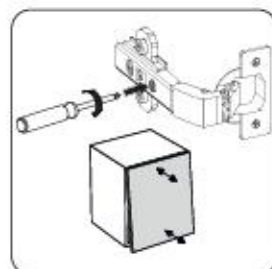
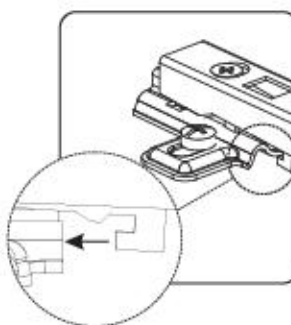
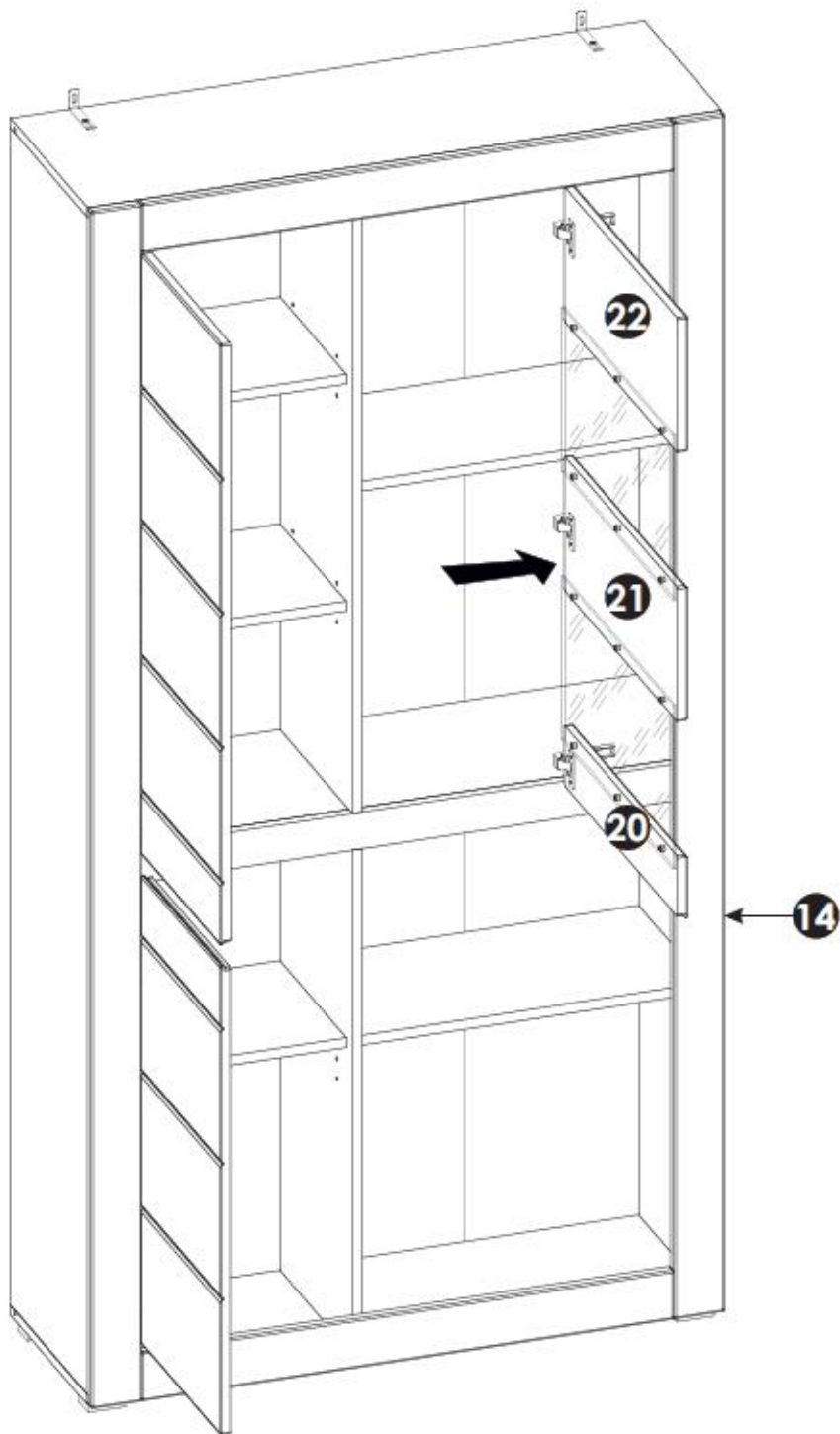

37▶

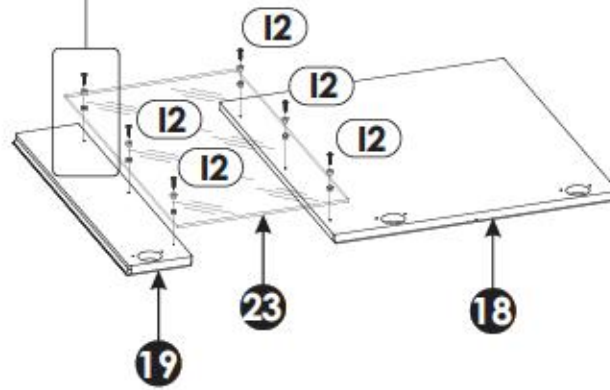
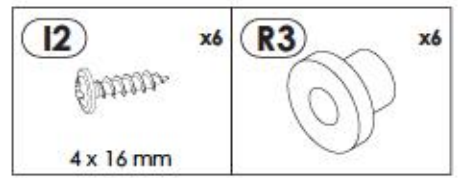
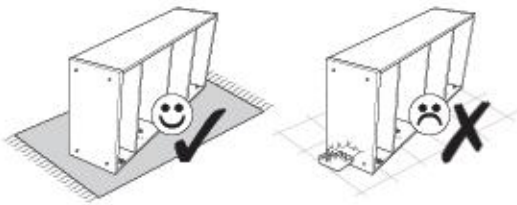

38▶

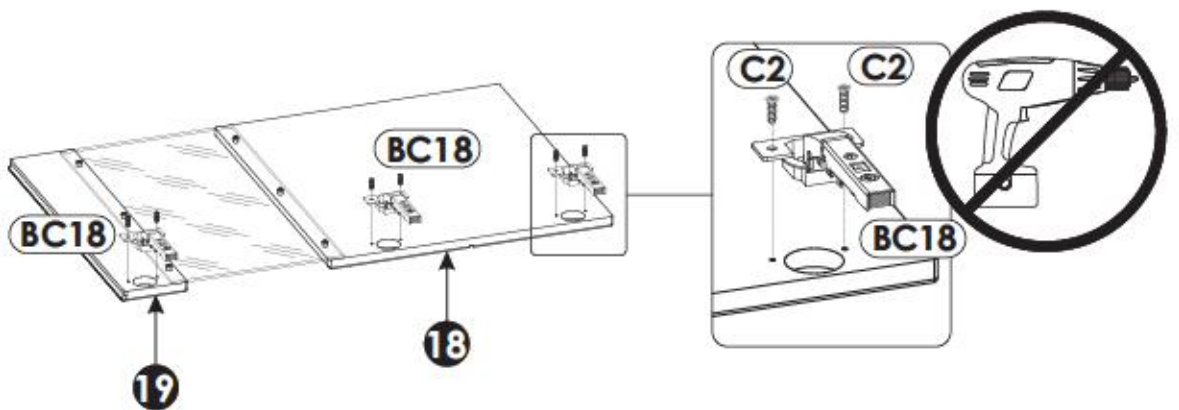
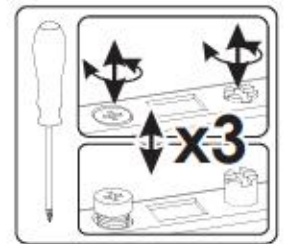
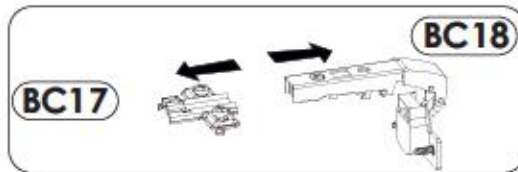
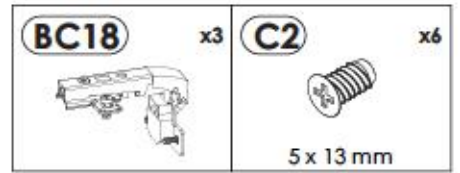
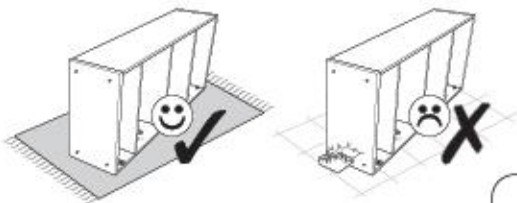

39 ▶

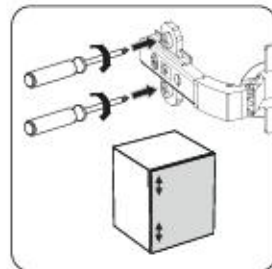
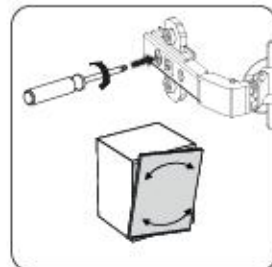
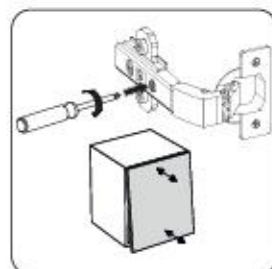
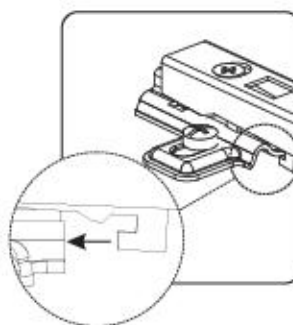
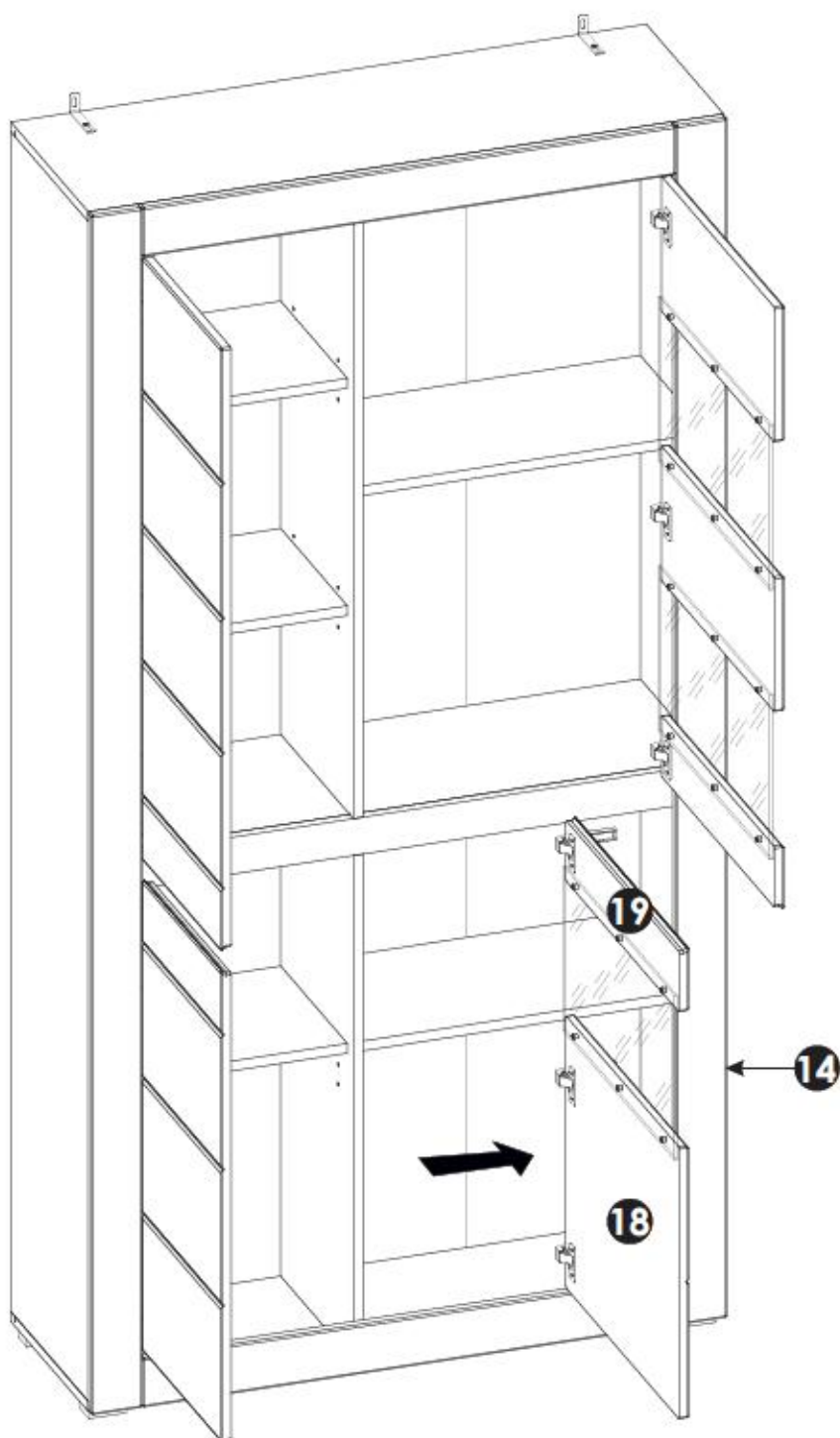

40▶

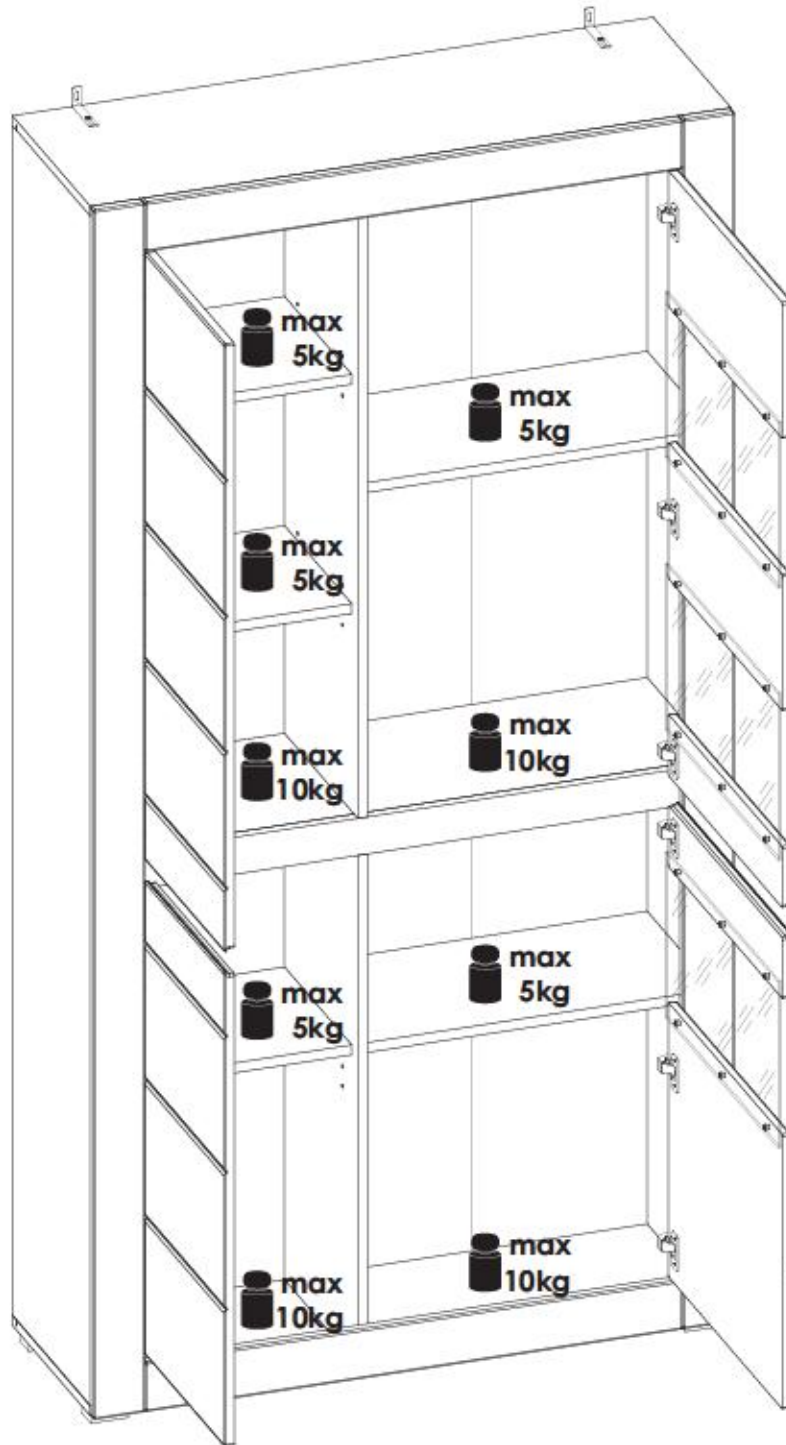

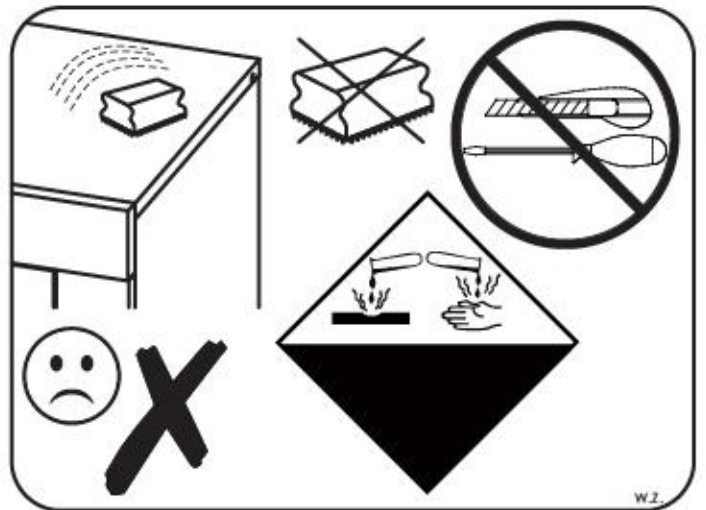
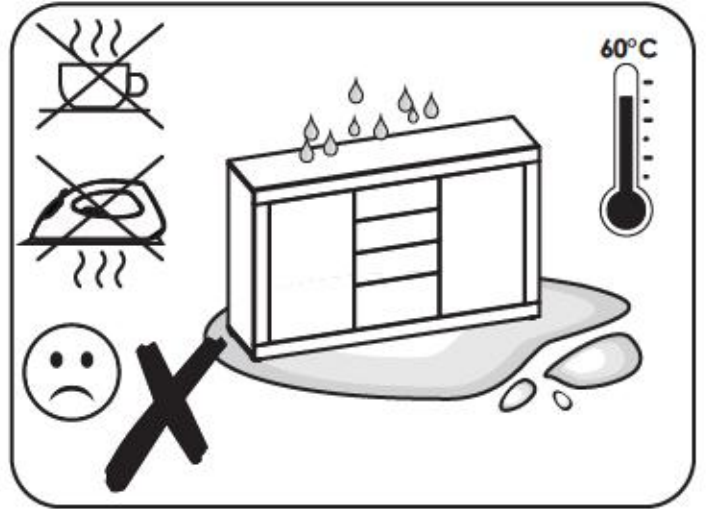
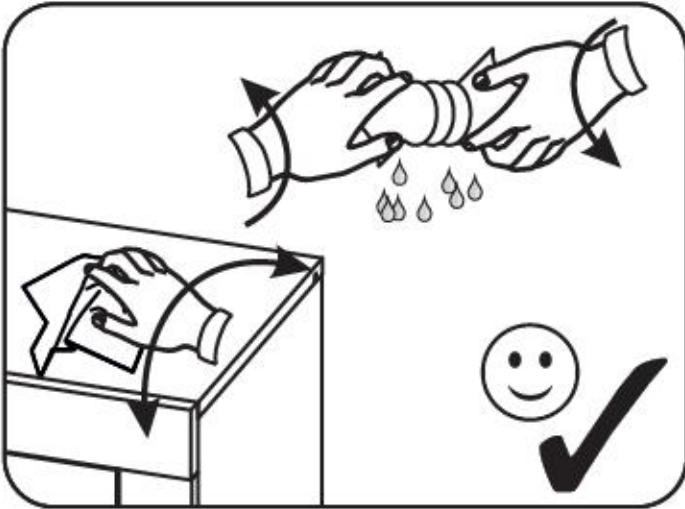
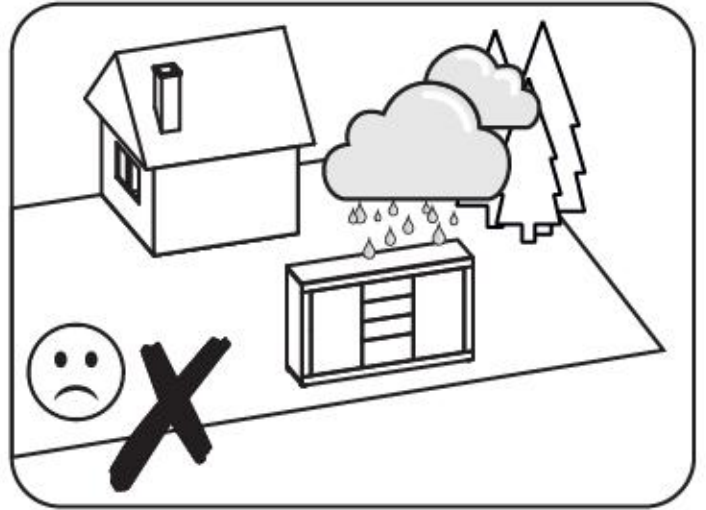
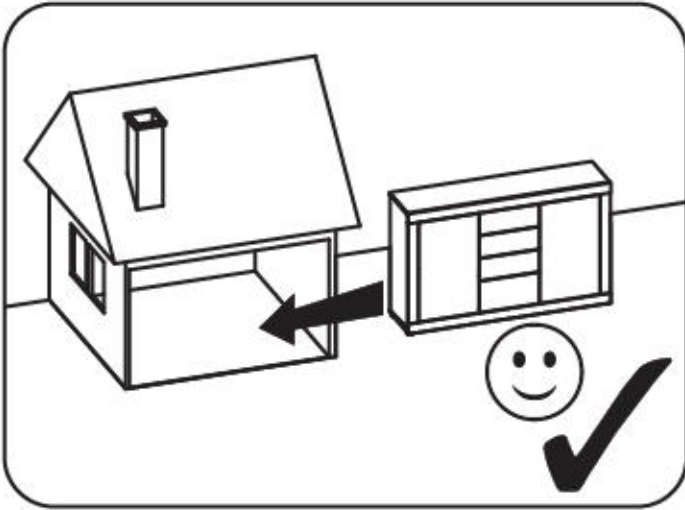

245FCA30

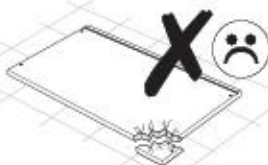
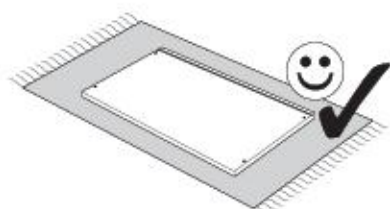
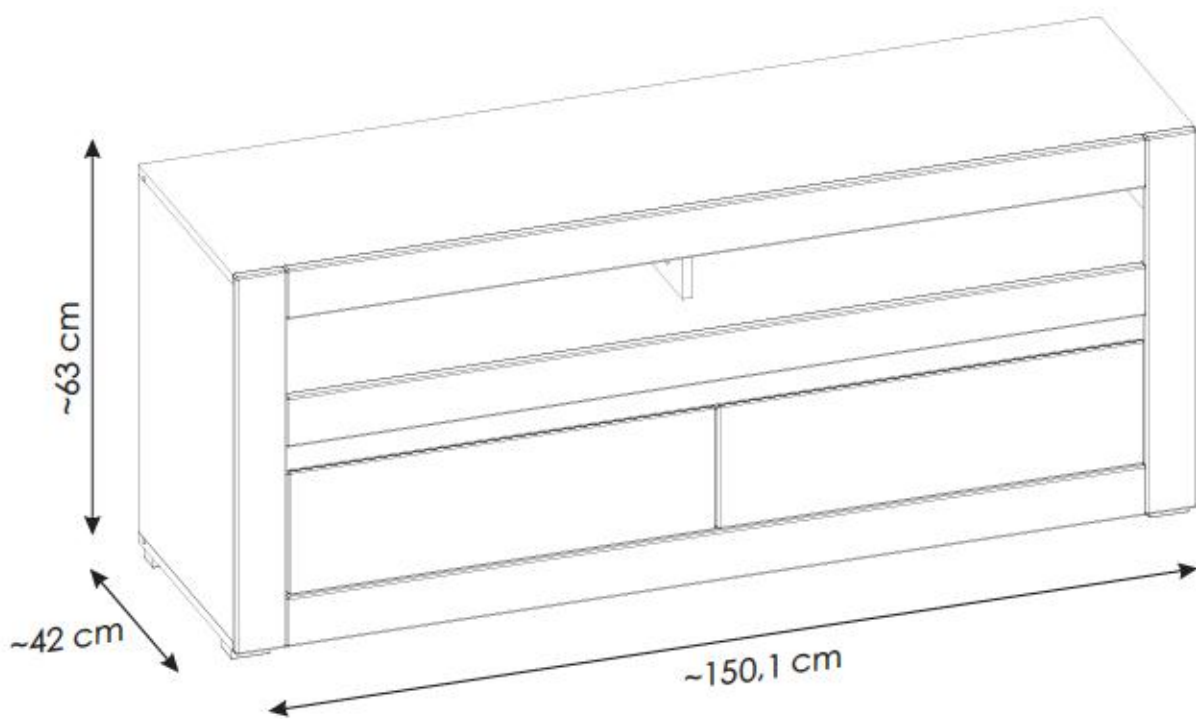

ملاحظة!

يجب تثبيت الأثاث بإحكام إلى الحائط أو الجدار لتجنب خطر إنقلابه. لا تحتوي العلبه على مسامير التثبيت، إذ إنه ينبغي إستعمال المسامير المخصصة لنوعية الحائط أو الجدار. اختر المسامير التي تناسب جدارك.

E.

¡ATENCIÓN! El mueble debe ser fijado permanentemente a la pared para evitar el riesgo relacionado con el vuelco del mueble. En el paquete no hay tornillos de fijación, ya que se debe elegir el tipo de fijación adecuado para el tipo de pared. Elija el apropiado para su tipo de pared.

CN.

注意！本家具需要固定在墙上以免倒塌。箱子里没有安装螺钉。因为安装方式需要根据墙的类型调整。请按照您的墙类型选择合适的安装方式。

SLO.

POZOR! Pohištvo trajno pritrđite na steno, da preprečite tveganje, da se prevrne. V paketu ni pritrđilnih vijakov, saj je treba način pritrđitve ustrezno izbrati glede na vrsto stene. Izberite način, ki je ustrezen za vašo steno.

HU.

FIGYELEM! Rögzítse a bútorokat a falhoz, hogy elkerülje a bútor felborulásának kockázatát. A készletben nem találhatóak rögzítőcsavarok, mivel a rögzítés típusa a fal típusától függ. Válassza ki a fal típusának megfelelő kötőelemeket.

NL.

OPMERKING! De meubelen moeten permanent aan de muur worden bevestigd om te voorkomen dat de meubelen kantelen. Er zitten geen bevestigingsschroeven in het pakket, omdat het type bevestiging moet worden gekozen op basis van het type muur. Kies de juiste voor uw type muur.

EN.

WARNING! To prevent this furniture from tripping over, fix it to the wall permanently. Fixing devices are not included since different wall materials require different types of fixing devices. Please make sure you chose the correct ones for your type of wall.

SK.

POZORI Nábýtok musí byť trvalo pripevnený k stene tak, aby sa zamedzilo riziku prevrátenia. Balík neobsahuje upevňovacie skrutky, pretože typ upevnenia je treba vybrať podľa typu steny. Vyberte typ vhodný pre Vašu stenu.

CZ.

POZORI Nábýtek je nutné pevně připevnit ke zdi, abychom se vyhnuli riziku spojenému s jeho převrnutím. Součástí balení nejsou připevňovací šrouby, protože způsoby připevnění je nutné zvolit podle druhu stěny. Vyberte správný pro Váš typ stěny.

RU.

ПРИМЕЧАНИЕ! Эту мебель необходимо всегда прикреплять к стене, чтобы избежать рисков, связанных с переворотом мебели. В пакете нет крепежных винтов, потому что тип крепления должен быть выбран в соответствии с типом стены. Выберите, пожалуйста, правильные винты к вашей стене.

RO.

ATENȚIE! Mobilă trebuie ancorată permanent în perete pentru a evita riscul de răsturnare a mobilei. În pachet nu sunt incluse șuruburile de fixare, deoarece tipul de ancoraj trebuie ales în funcție de tipul de perete. Alegeți șuruburile potrivite pentru tipul Dvs. de perete.

TR.

DIKKAT! Devrimle riskini önlemek için mobilya duvara sabitlenmelidir. Sabitleme civataları pakete dahil değildir, çünkü sabitleme tertibatının tipi, duvara tipine uygun olarak seçilmelidir. Onu duvannızın tipine göre seçiniz.

PL.

UWAGA! Mebel należy trwale zamocować do ściany, aby uniknąć ryzyka związanego z przewróceniem się mebla. W paczce nie ma śrub mocujących, ponieważ rodzaj mocowania należy odpowiednio dobrać do rodzaju ściany. Dobierz właściwe do Twojego rodzaju ściany.

D.

ACHTUNG! Um alle mit dem Umkippen des Möbels verbundenen Risiken auszuschließen, muss das Möbel fest an der Wand verankert werden. Beschläge für die Wandbefestigung sind nicht beige packt, da diese von der jeweiligen Wandbeschaffenheit abhängig sind. Bitte solche Befestigungsschläge wählen, die für die heimischen Wände geeignet sind.

FR.

ATTENTION! Ce meuble doit être fixé en permanence au mur pour éviter les risques de chute. Les vis de fixation ne sont pas livrées car le type de fixation doit être choisi en fonction du type de mur. Sélectionnez les fixations adaptées au mur.

I.

ATTENZIONE! Il mobile deve essere permanentemente fissato alla parete per evitare i rischi derivanti da un ribaltamento del mobile. La confezione non include le viti di fissaggio, in quanto il tipo di fissaggio deve essere scelto in base al tipo di parete. Utilizzare viti appropriate in base al materiale della parete.

HR.

NAPOMENA! Namještaj mora biti trajno pričvršćen za zid, kako bi se izbjegao rizik od njegovog prevrtanja. U paketu nema vijaka za pričvršćivanje, jer se vrsta montaže mora prilagoditi vrsti zida. Odaberite pravu vrstu prema Vašoj vrsti zida.

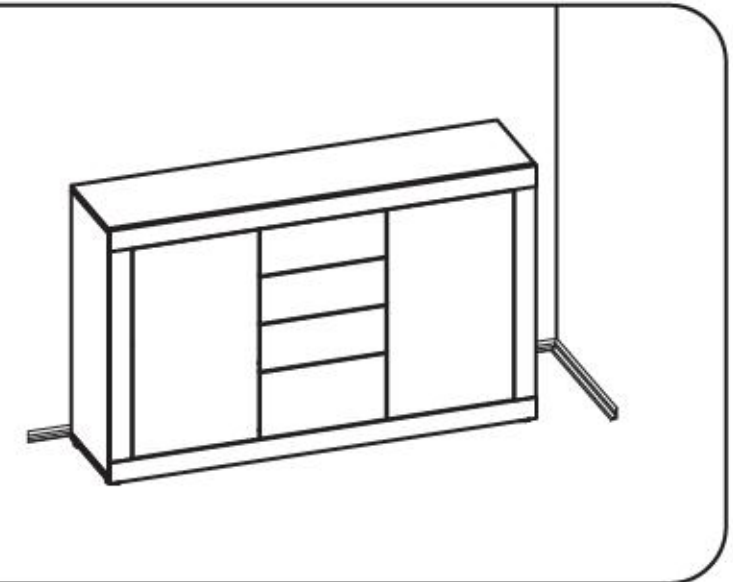
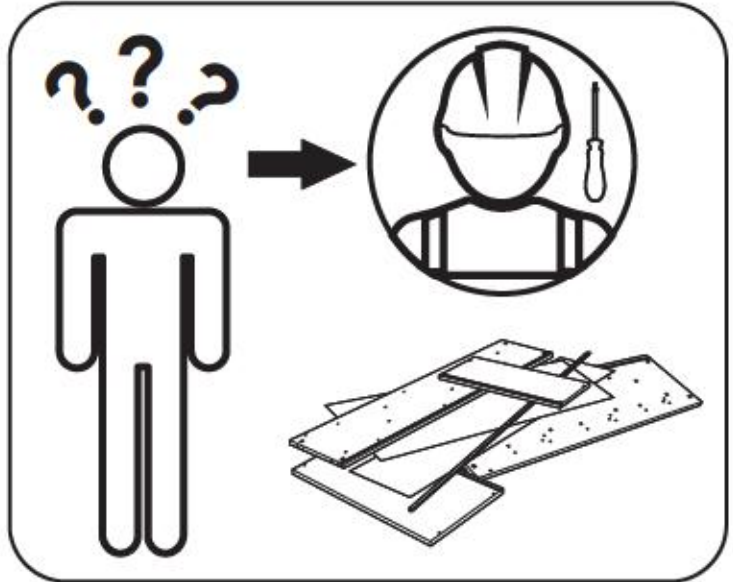
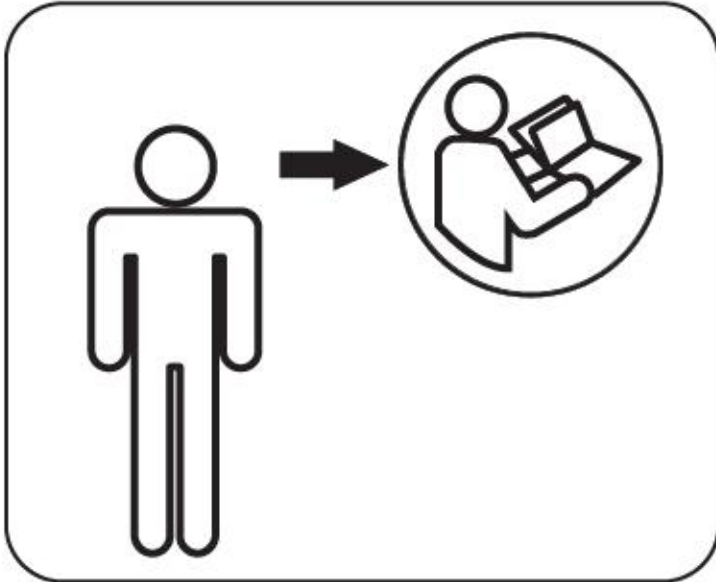
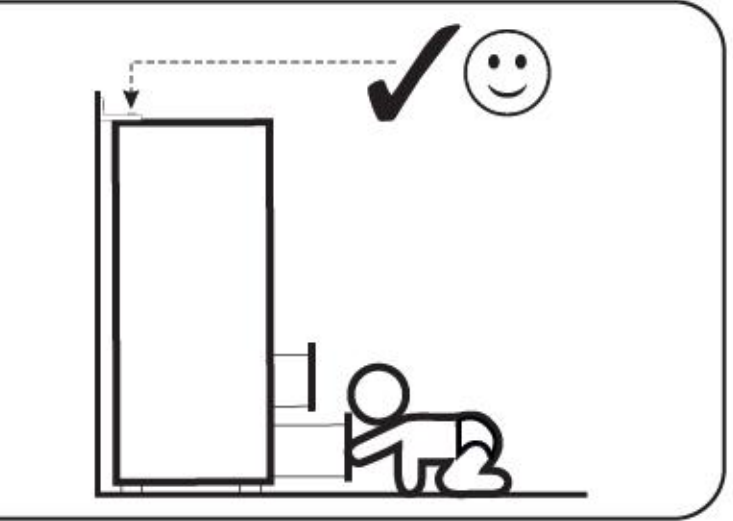
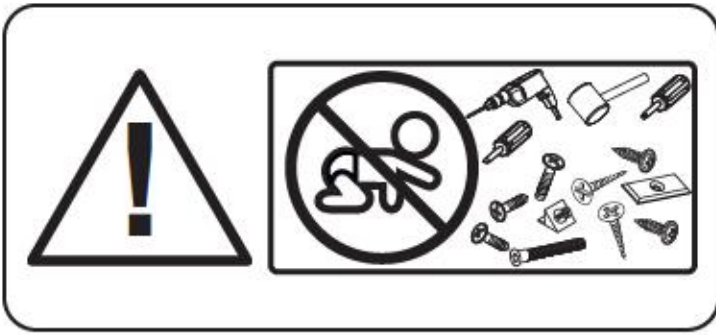

245FCA30

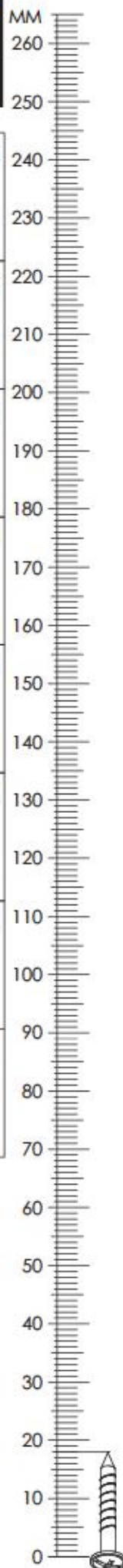

A1	8 x 35 mm	x60	A2	8 x 45 mm	x6	C2	5 x 13 mm	x8
E0	Ø16	x18	E1	15 x 12 mm	x46	F1	6 x 34 mm	x34
F3	7 x 64 mm	x6	G1	7 x 50 mm	x14	I2	4 x 16 mm	x2
I3	3,5 x 22 mm	x8	I4	3,5 x 27 mm	x1	M		x1
N1	3 x 16 mm	x30	N5	3,5 x 16 mm	x2	O1		x1
O3		x4	P24		x2	Q8		x1
Q9		x2	R1		x9	R4		x14
T13		x2	TZ	L R	x2	Z		x1

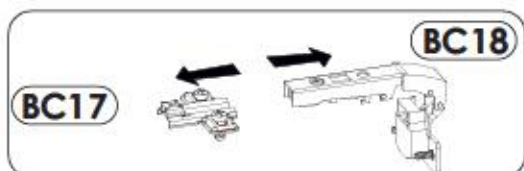

245FCA30

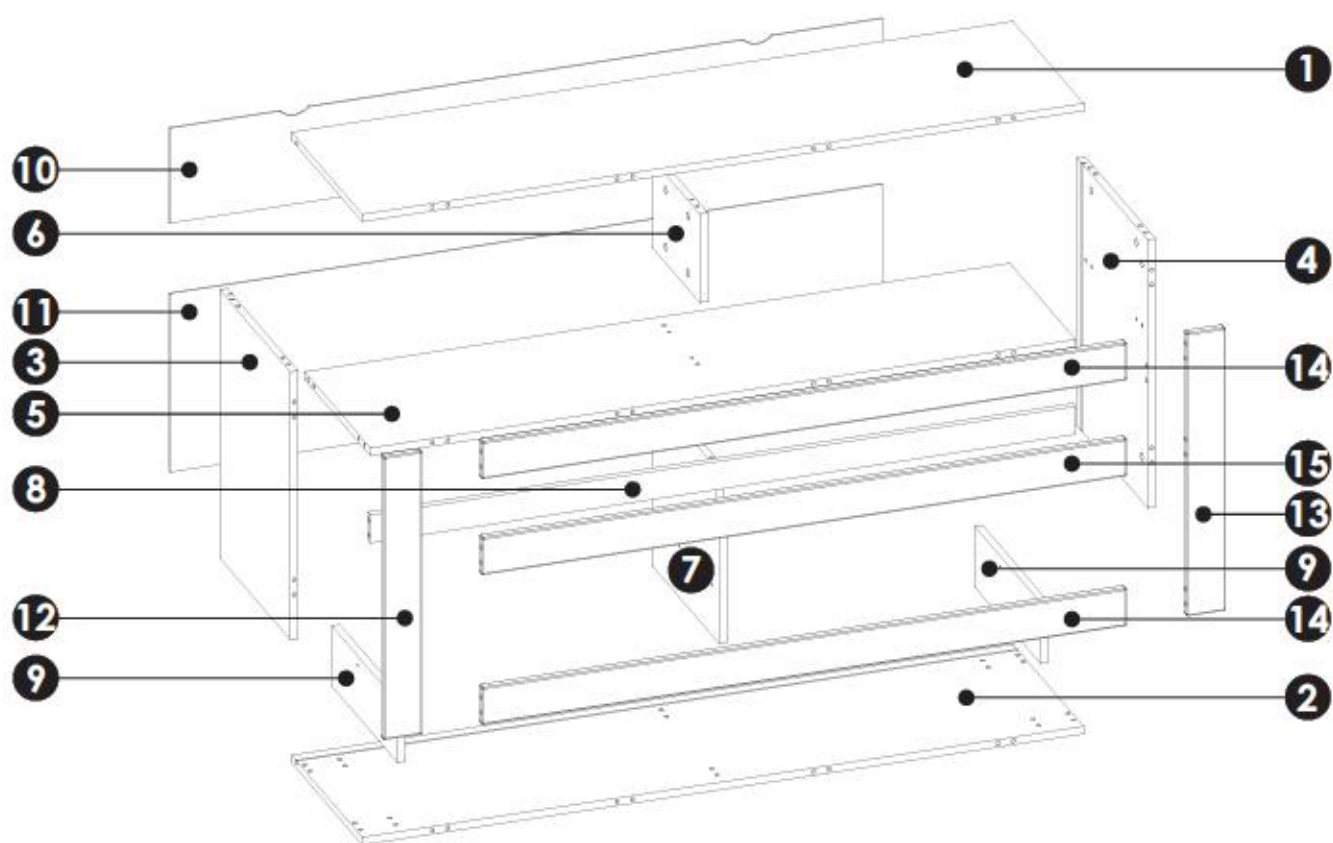
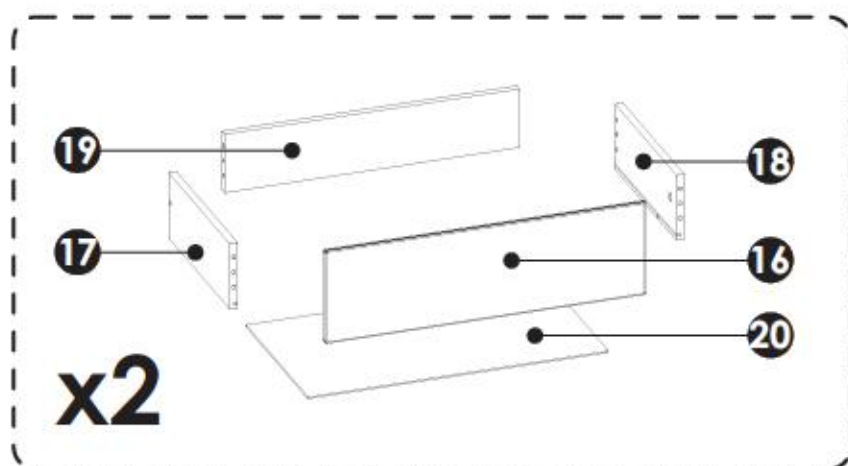
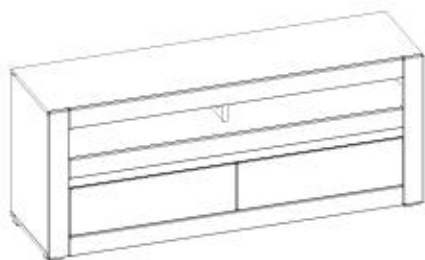

1	1501	404	16	x1	2/2
2	1501	404	16	x1	2/2
3	578	404	16	x1	1/2
4	578	404	16	x1	1/2
5	1468	376	16	x1	2/2
6	191	266	16	x1	2/2
7	371	376	16	x1	1/2
8	1468	60	16	x1	2/2

9	130	376	16	x2	1/2
10	1482	205	3	x1	2/2
11	1482	385	3	x1	2/2
12	610	80	16	x1	2/2
13	610	80	16	x1	2/2
14	1341	80	16	x2	2/2
15	1341	80	16	x1	2/2
16	666	200	16	x2	1/2

17	350	140	16	x2	1/2
18	350	140	16	x2	1/2
19	613	126	16	x2	1/2
20	625	355	3	x2	1/2

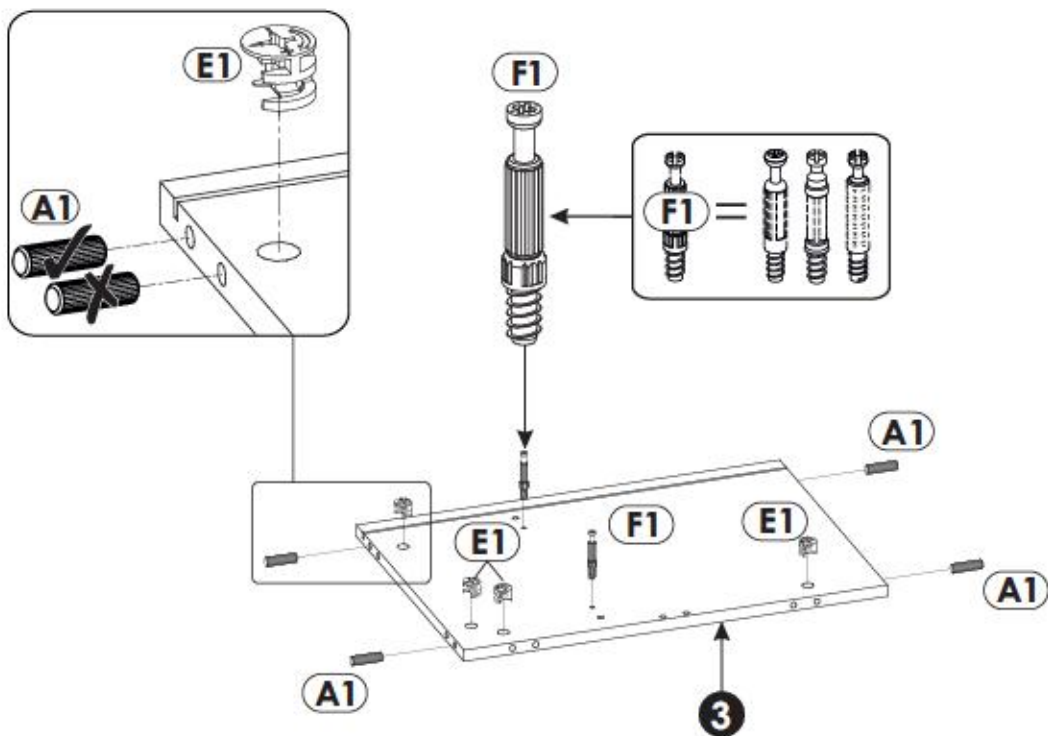
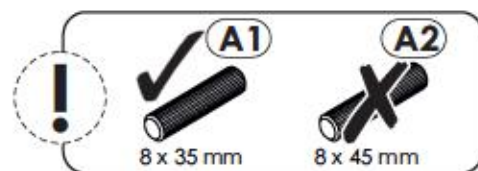
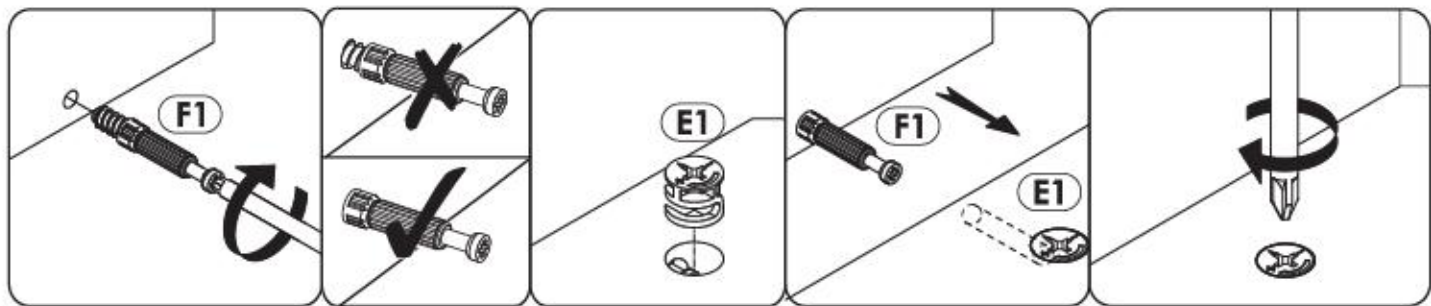

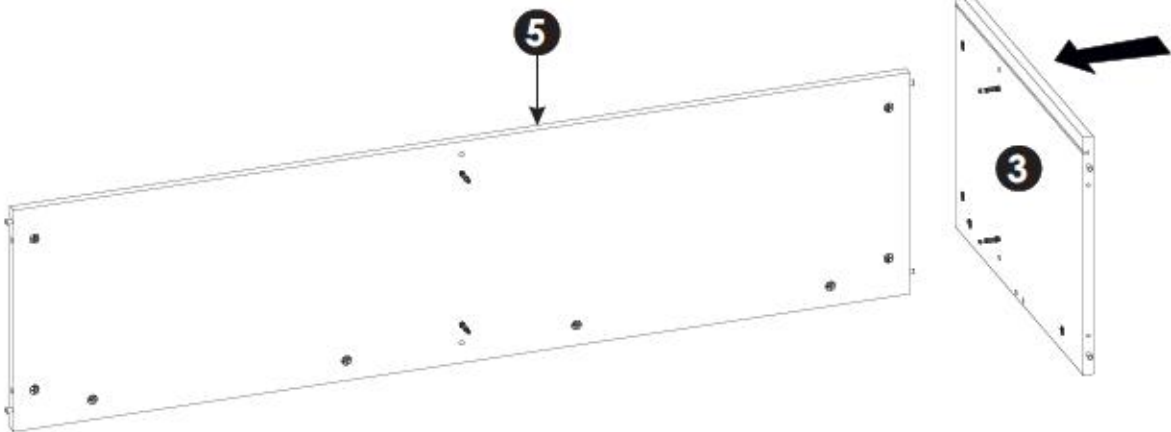
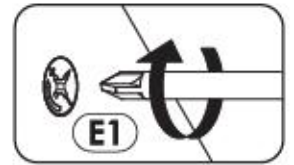
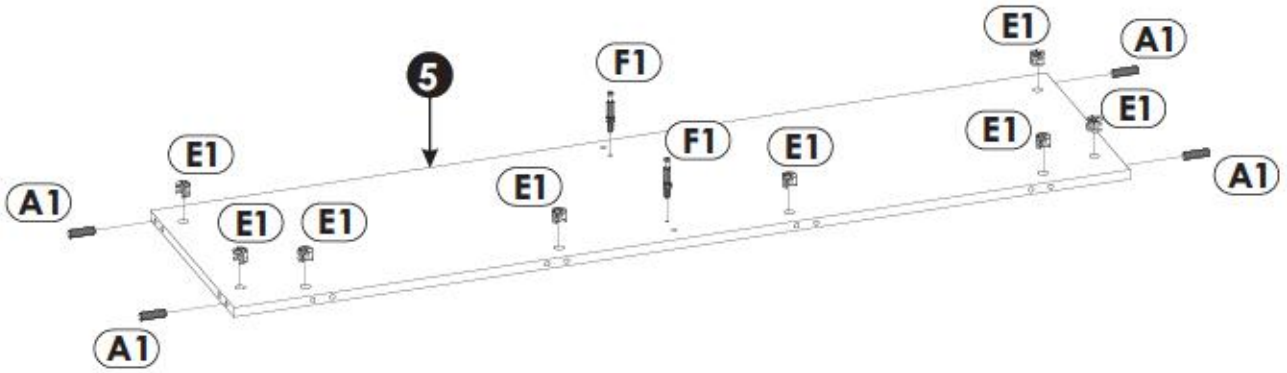
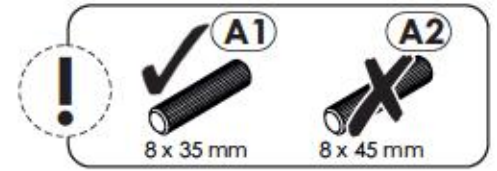
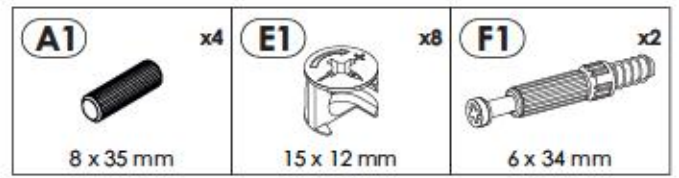

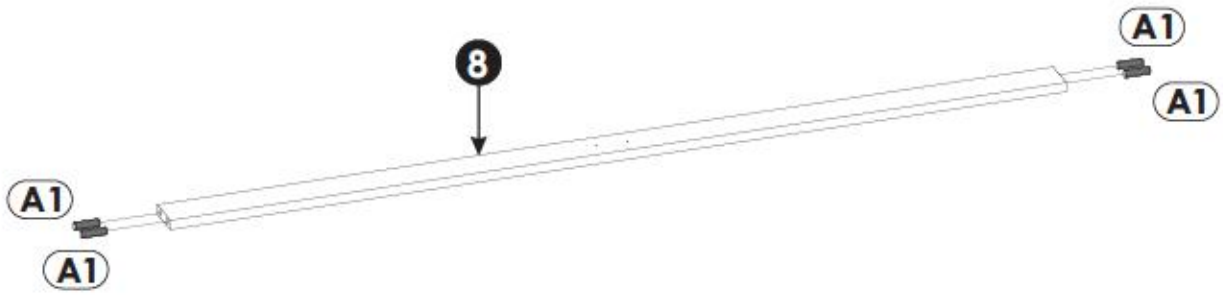
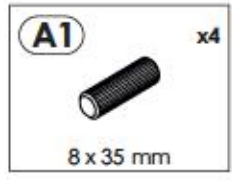
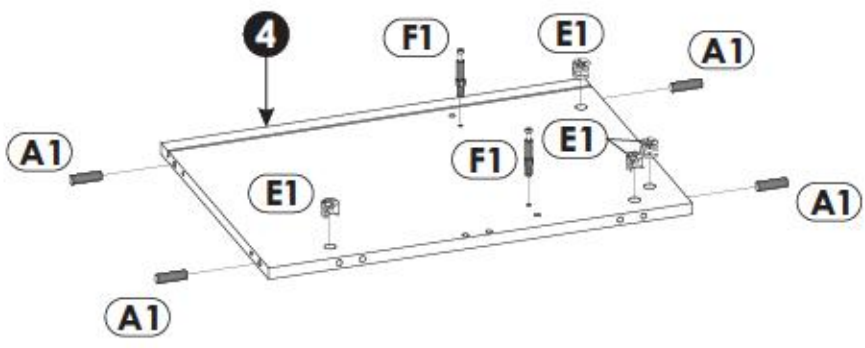
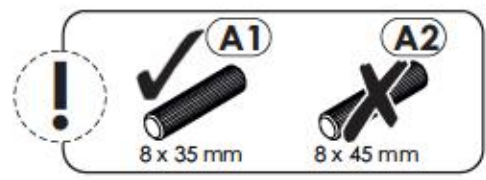
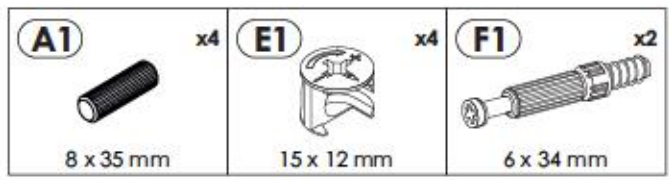

6 ▶

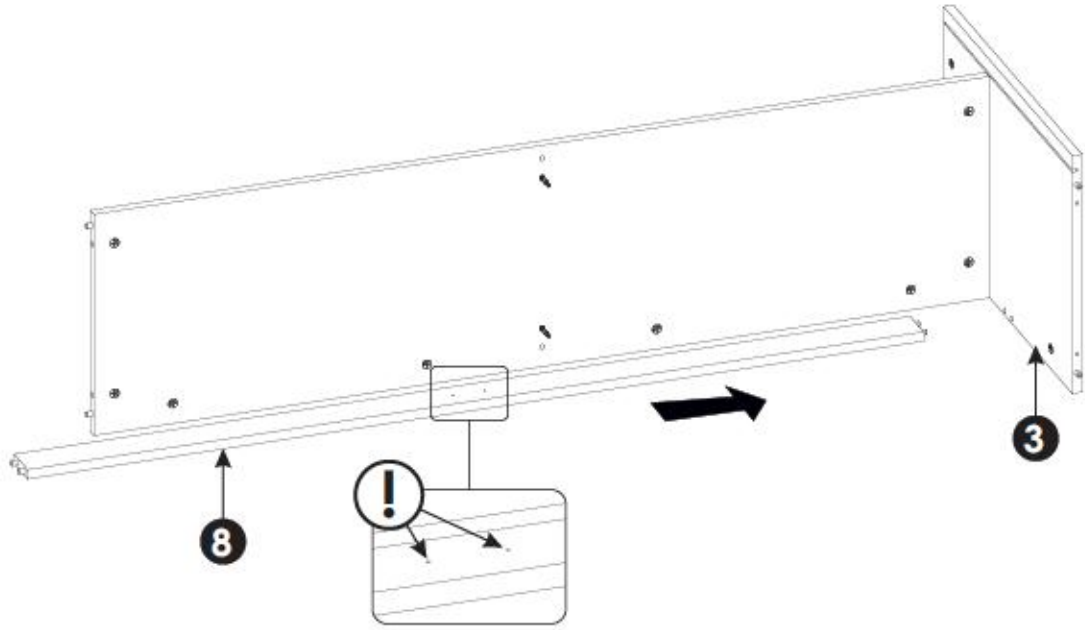
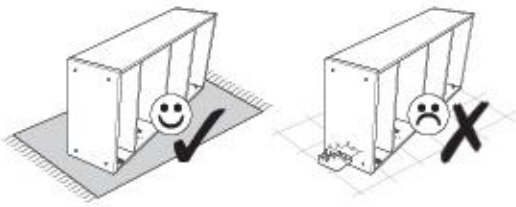

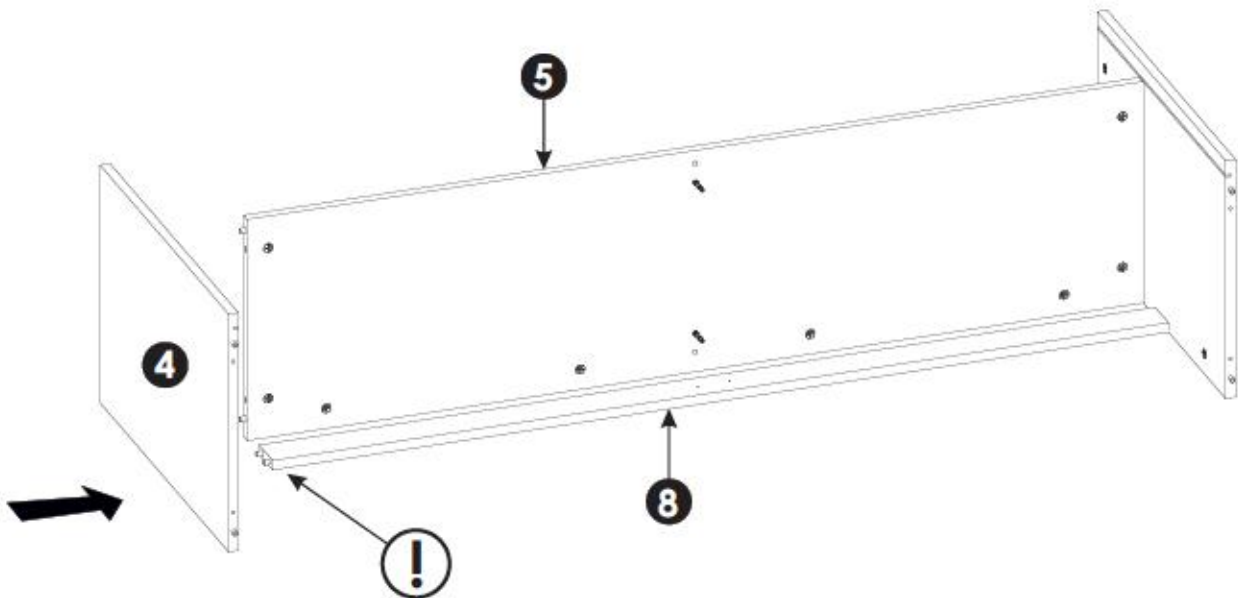
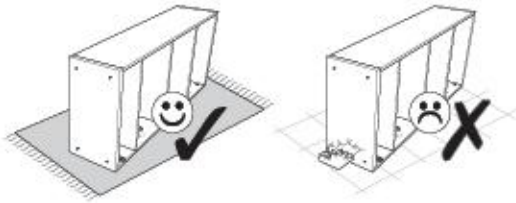

7 ▶

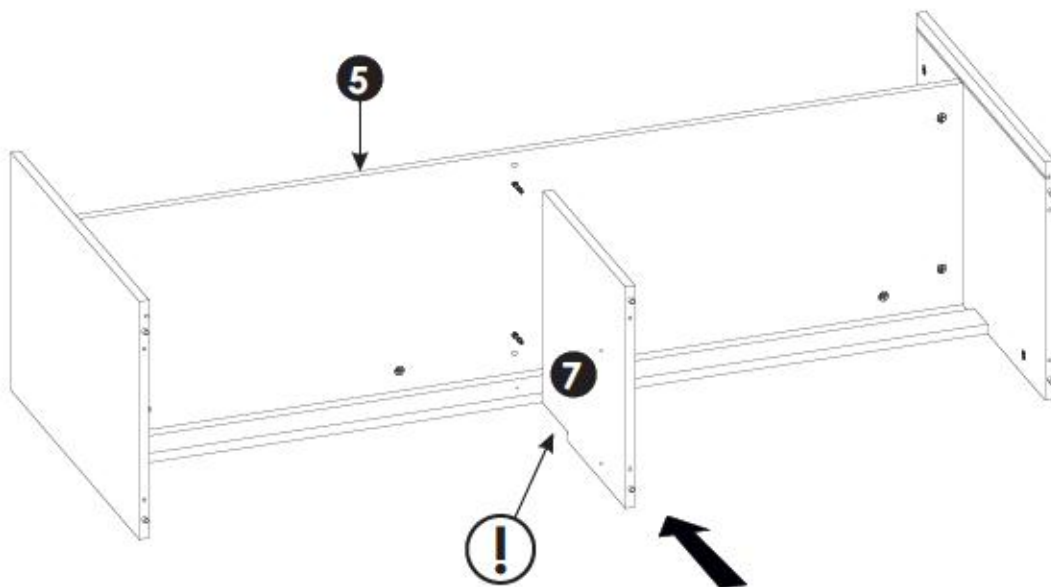
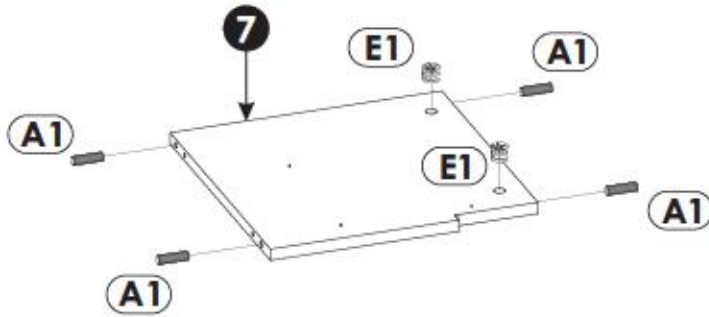
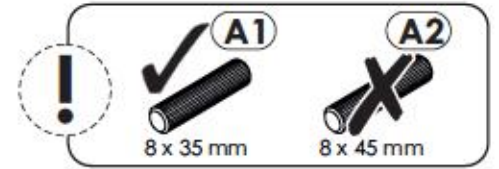
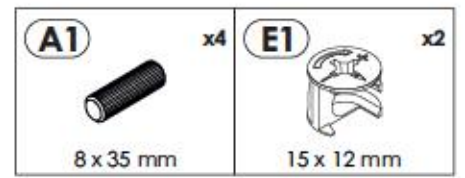

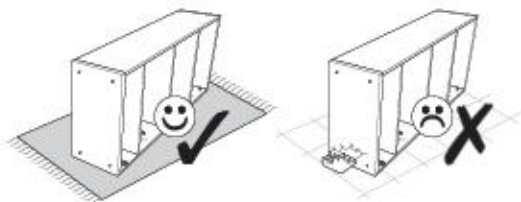

10 ▶



N5  3,5 x 16 mm	x2	Q8 	x1
---	----	---	----

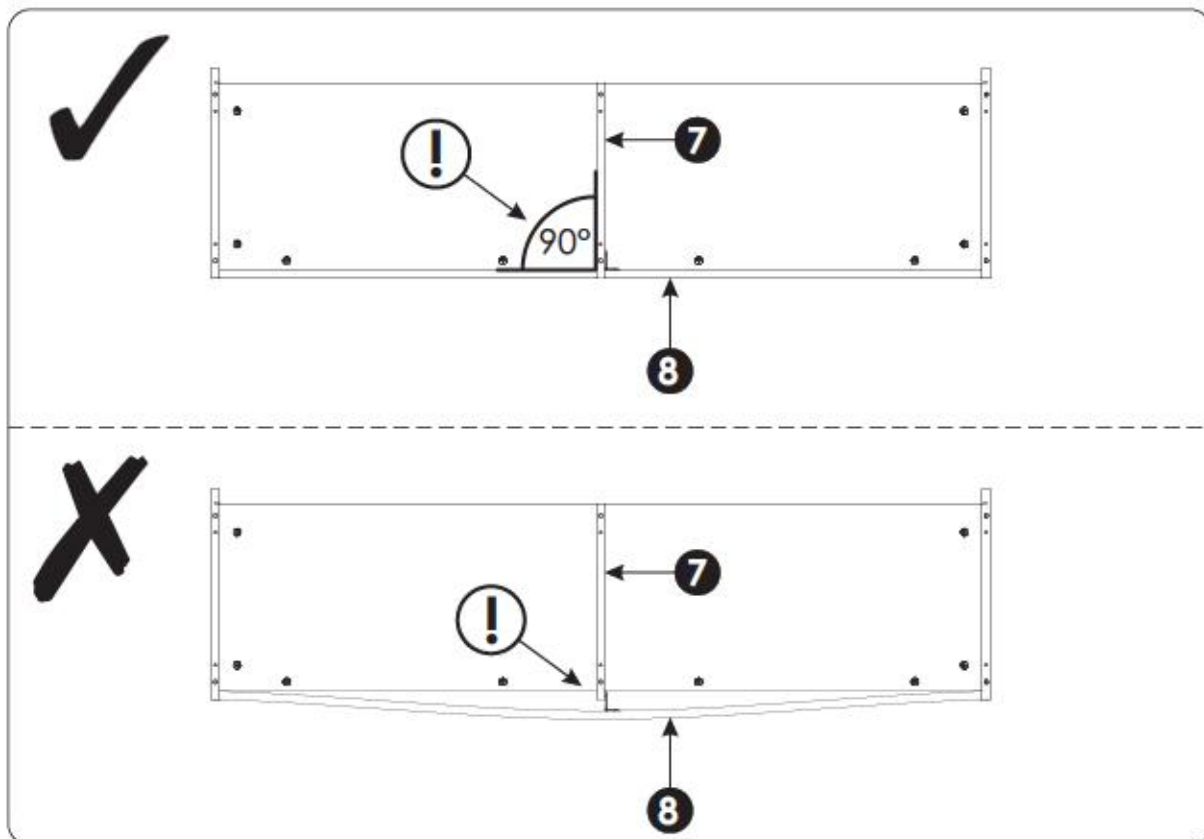
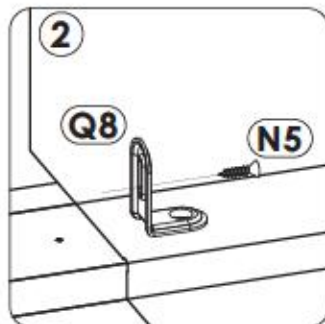
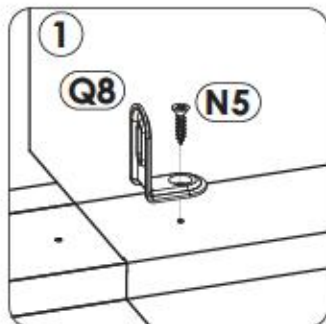
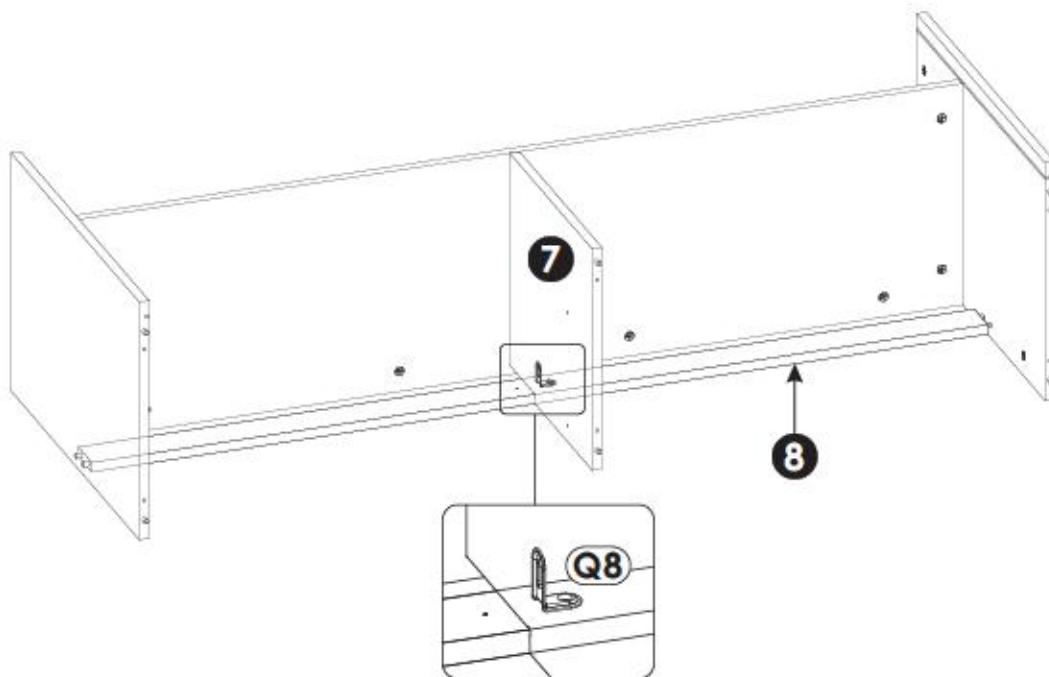

11▶

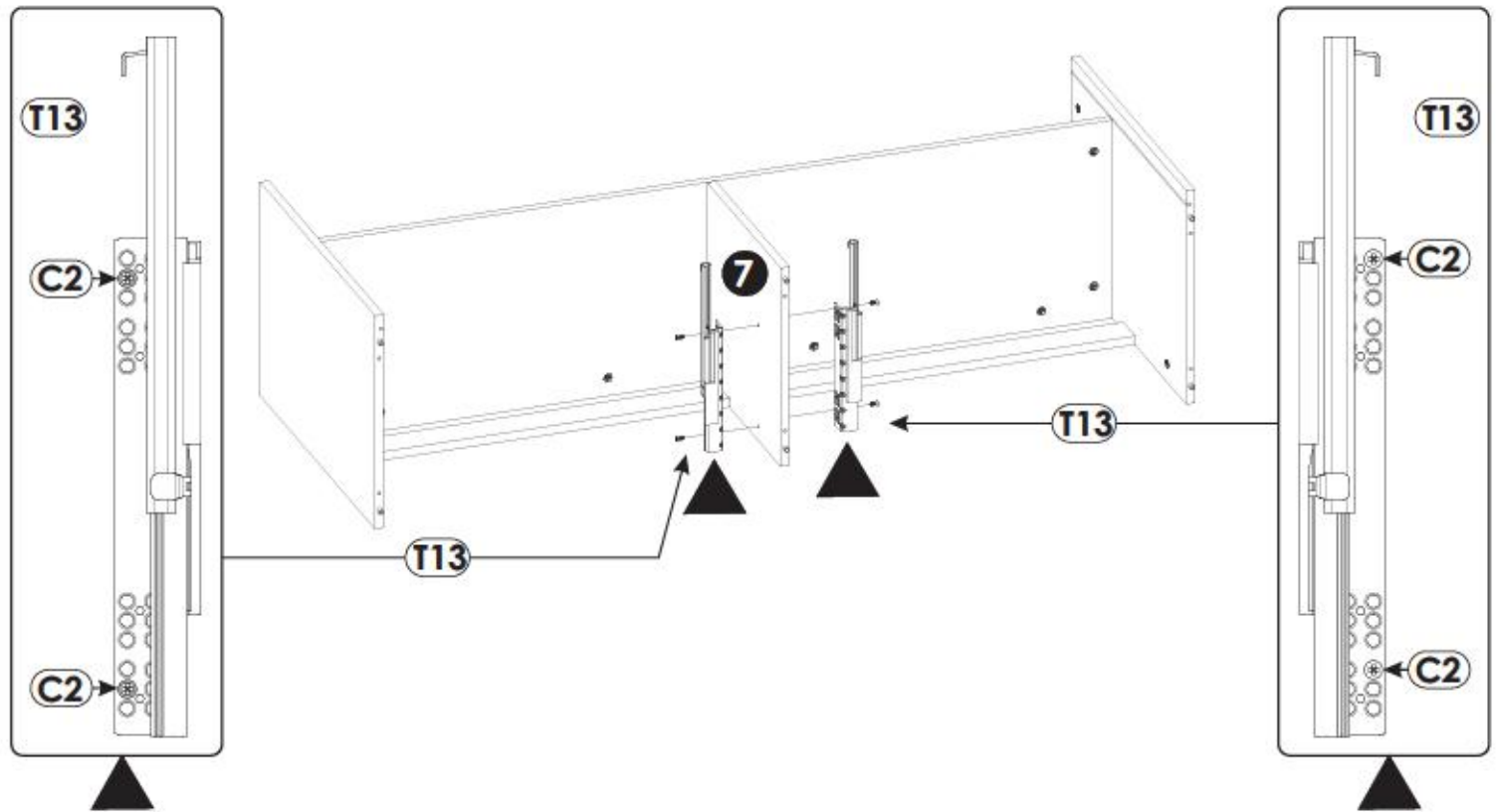
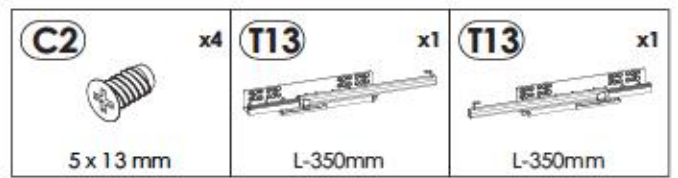
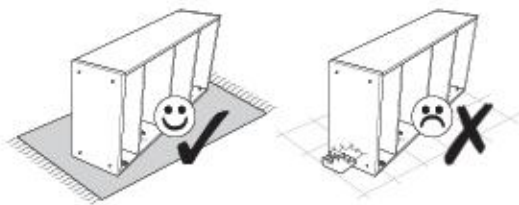

12▶

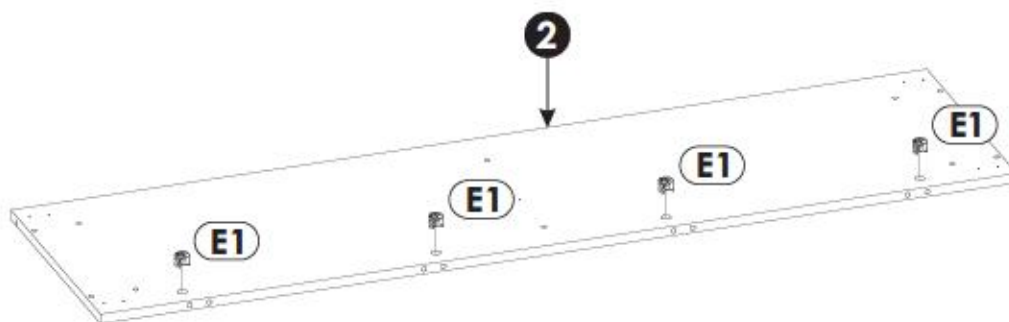

13▶

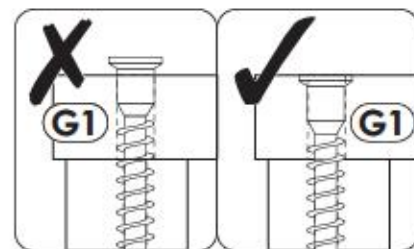
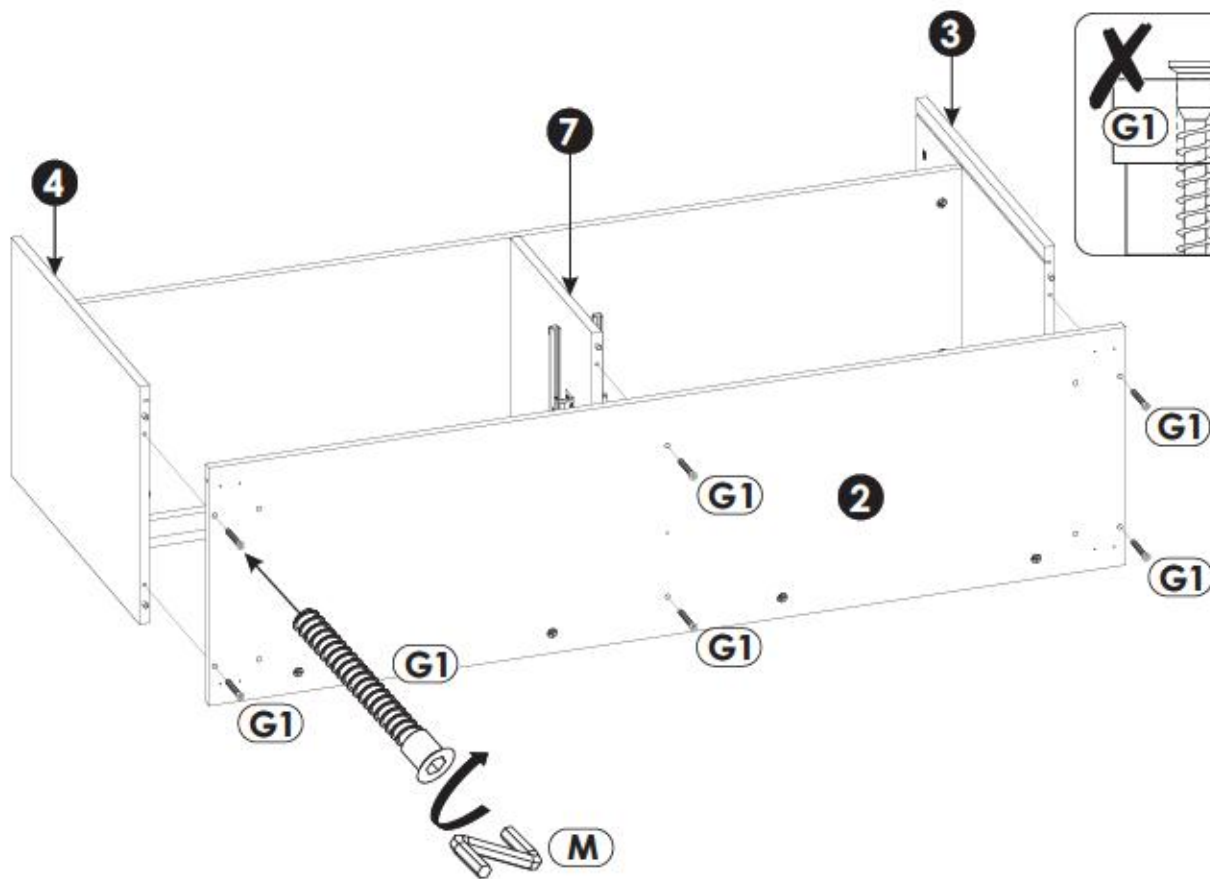
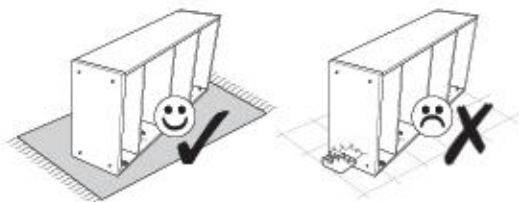

14▶

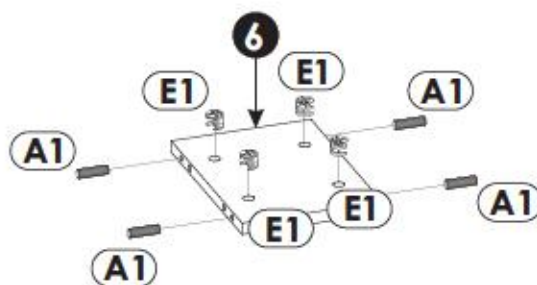
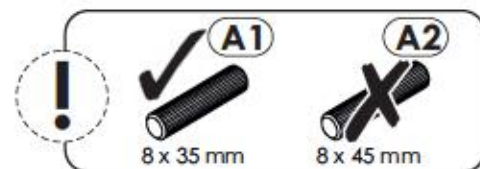

15▶

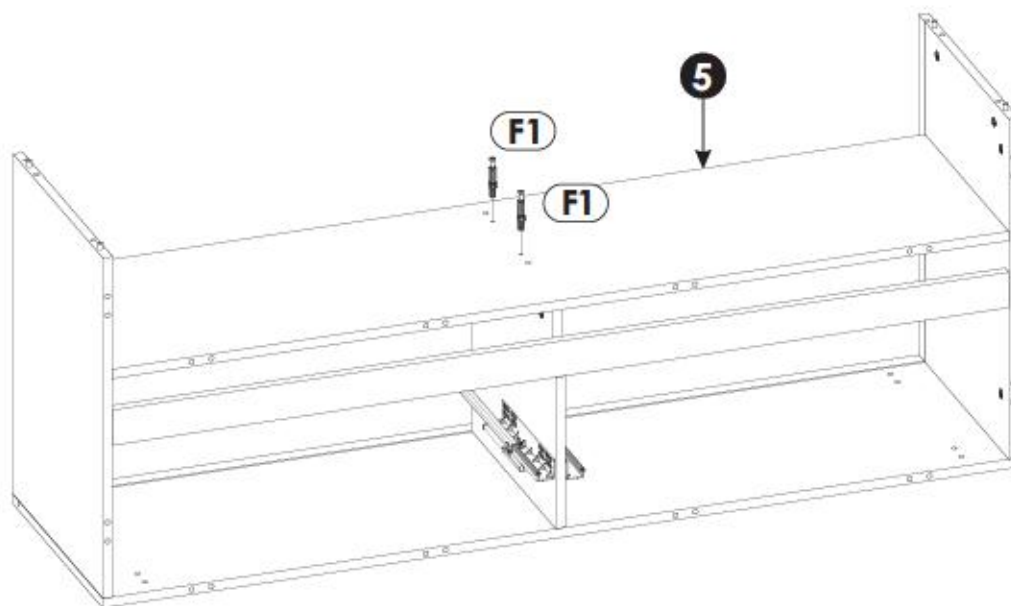
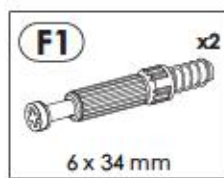
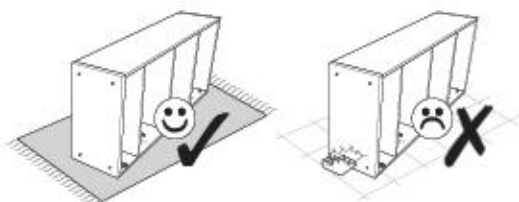

16▶

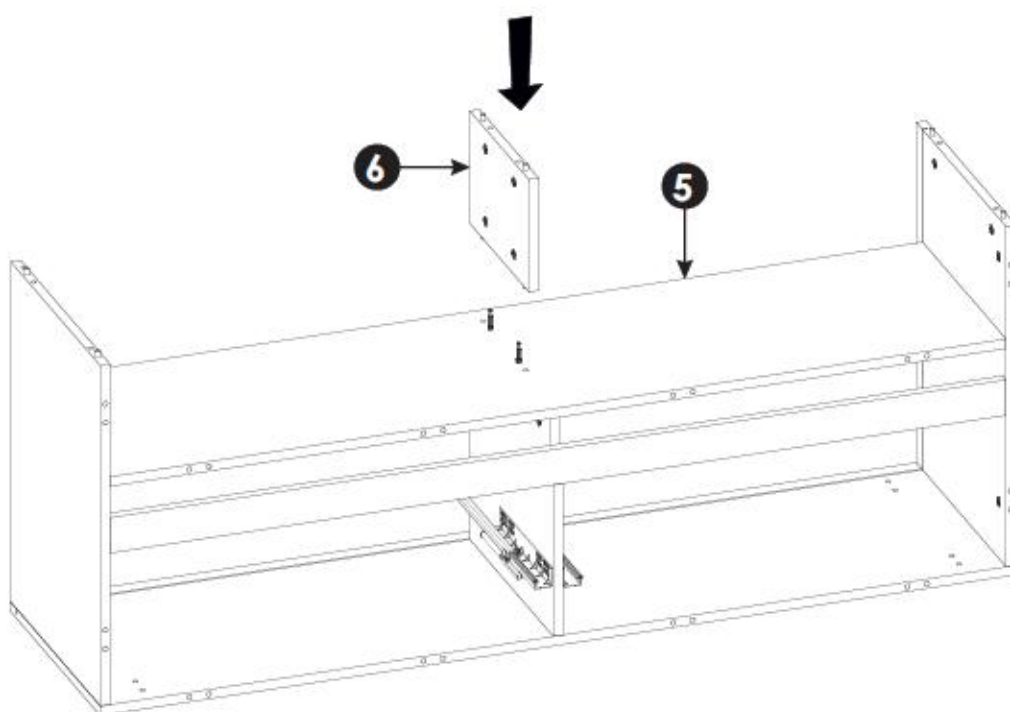
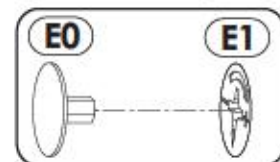
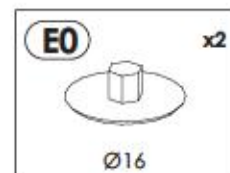
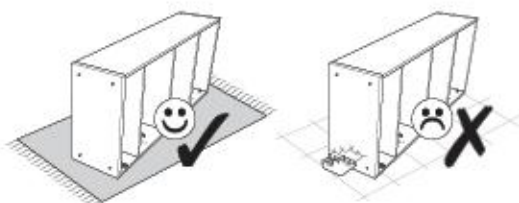

17▶

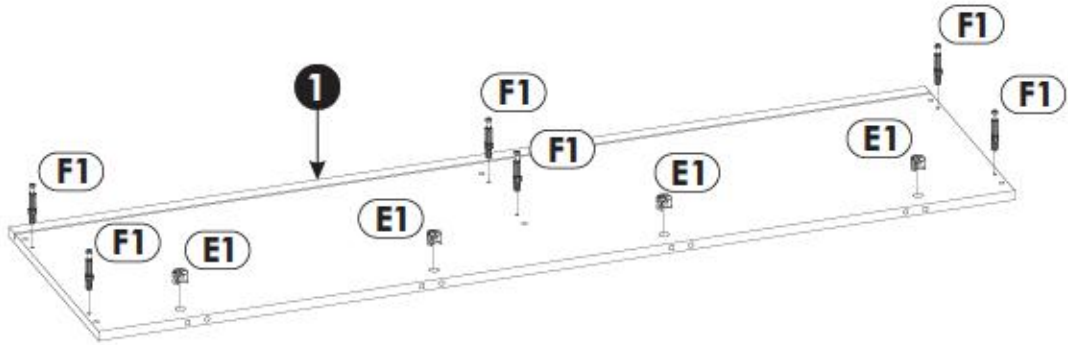
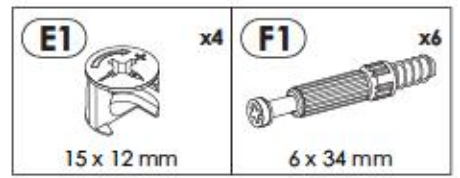

18▶

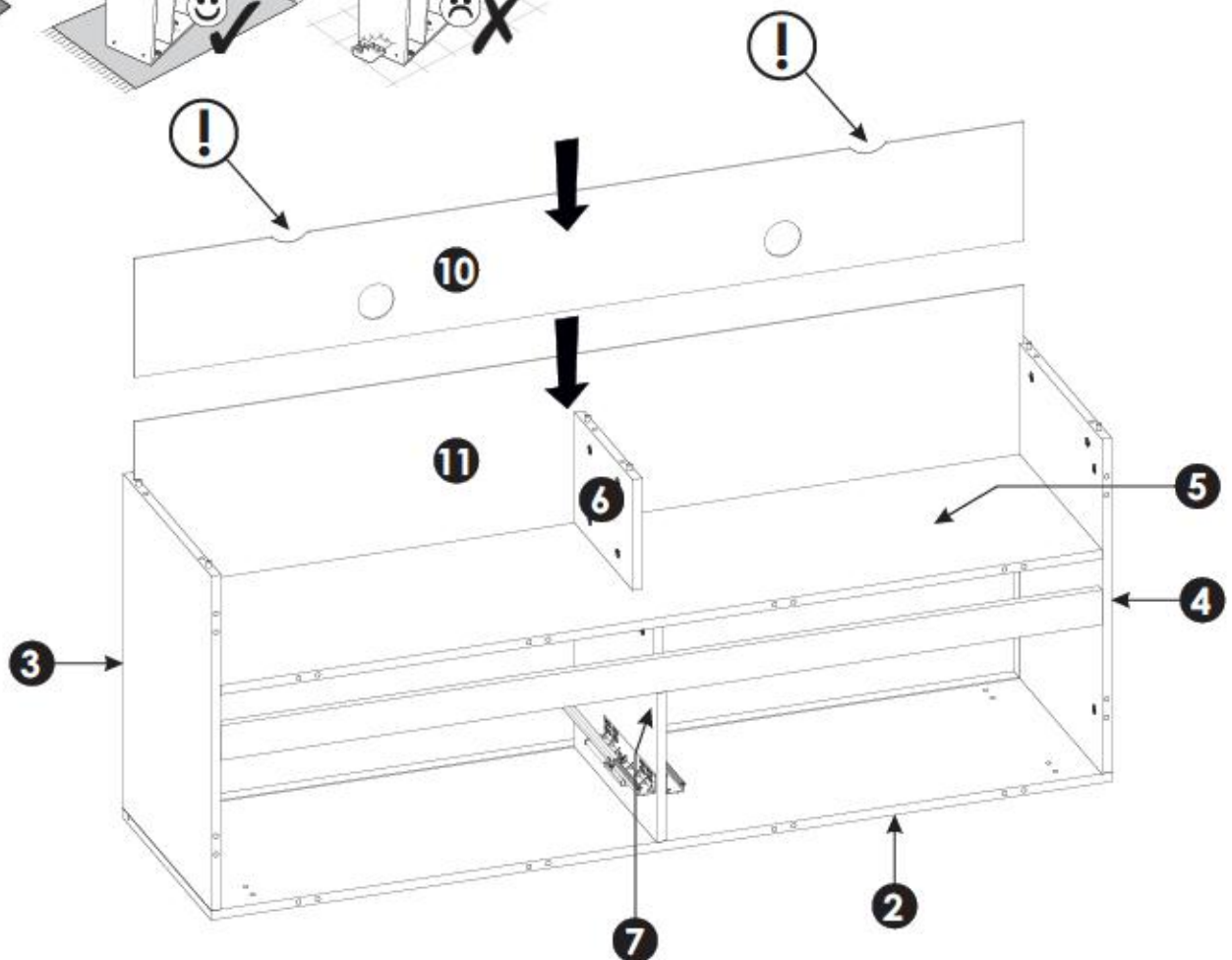
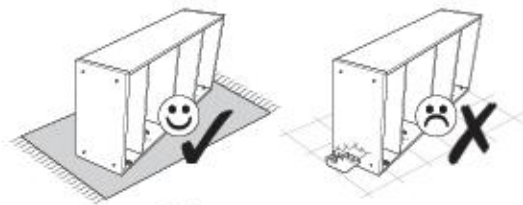

19▶

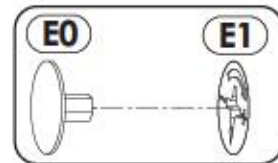
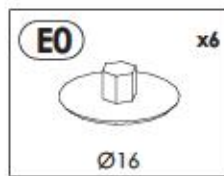
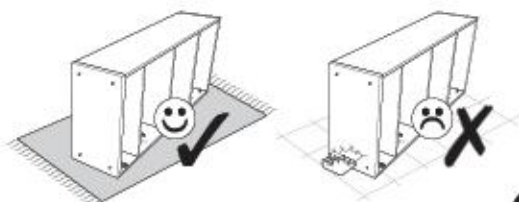

10

1



6

4

3

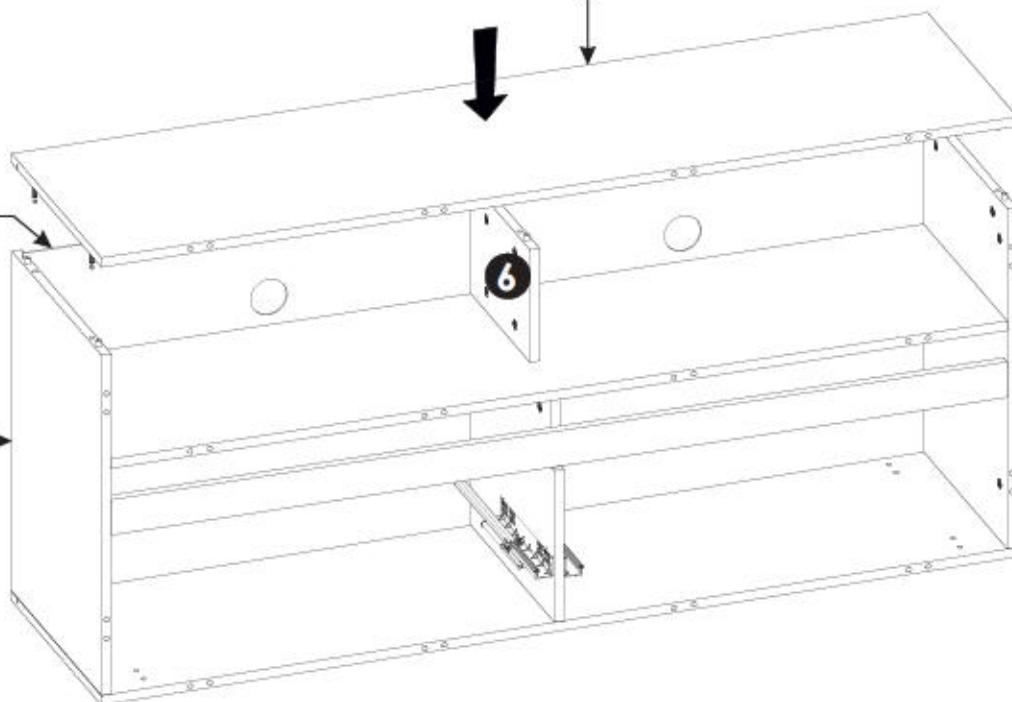

20▶

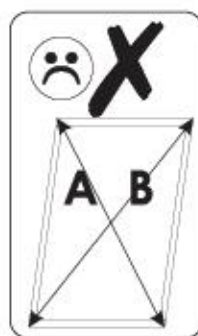
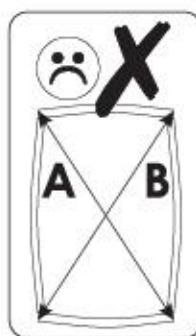
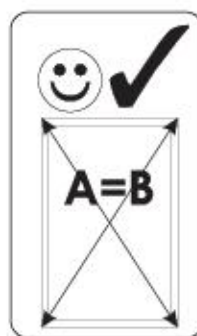
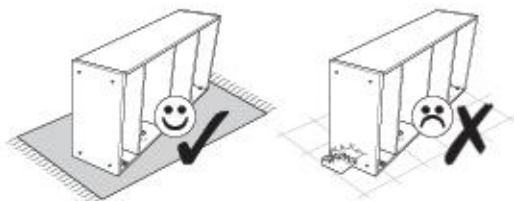

A=B

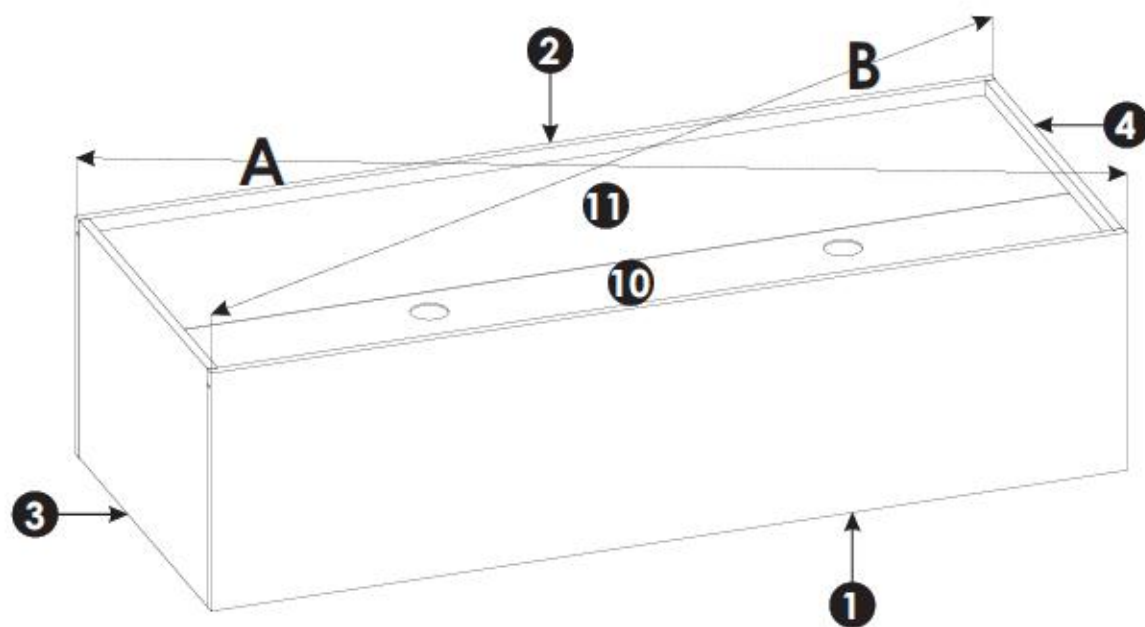

21 ▶

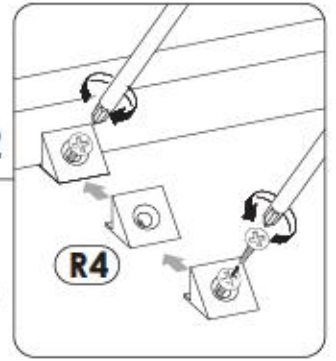
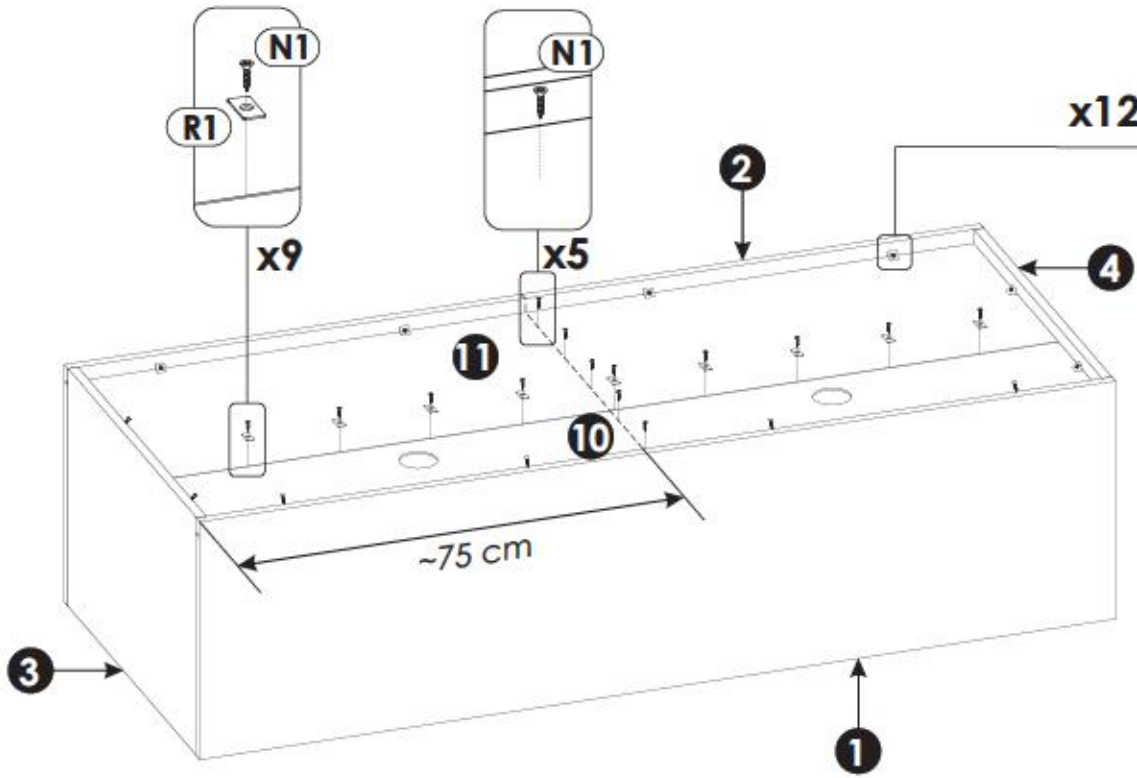
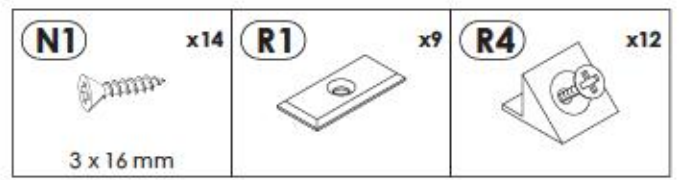
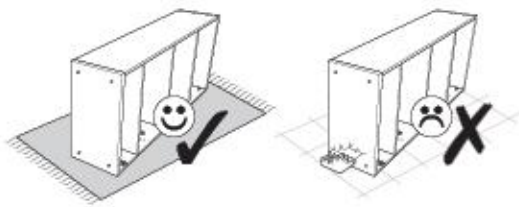

22 ▶

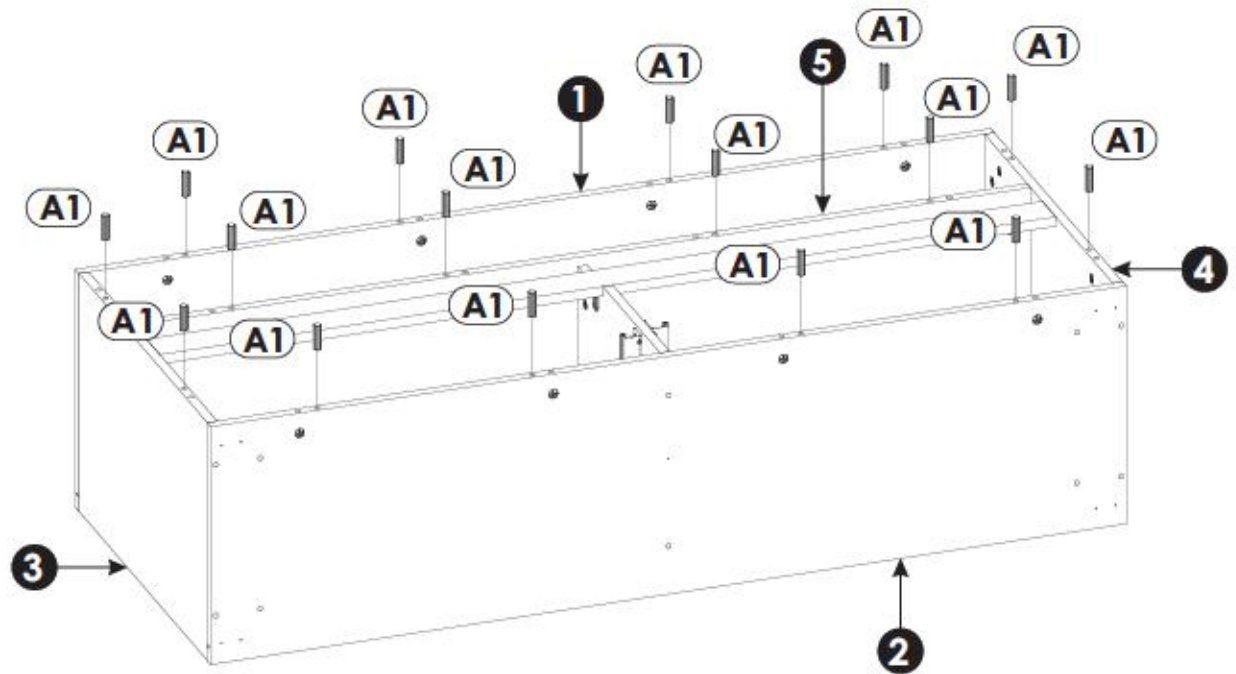
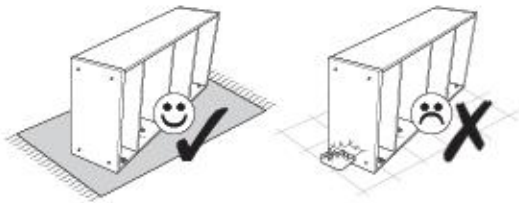

23▶

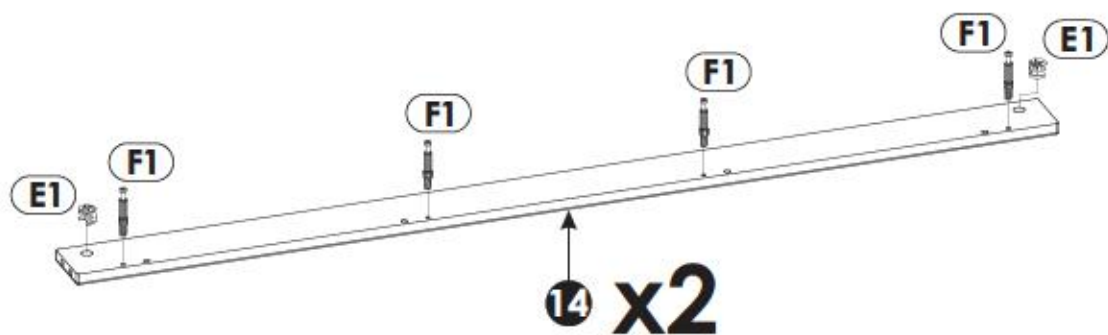
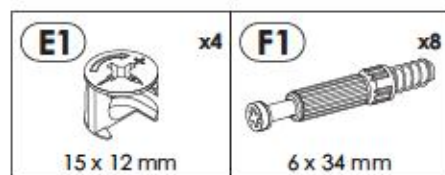

24▶

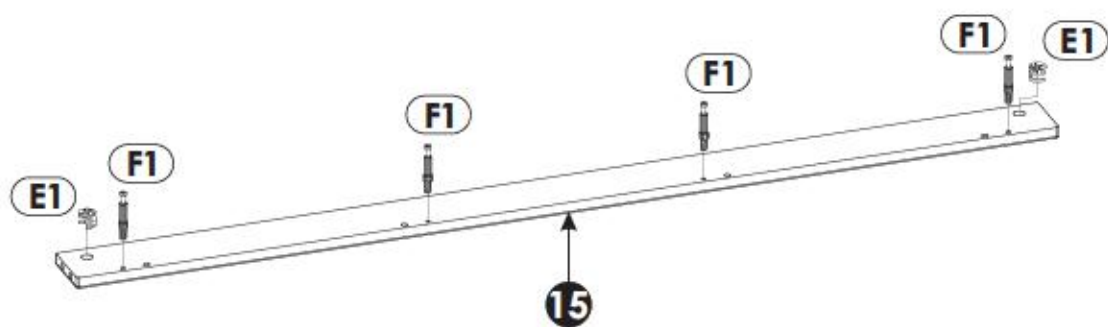
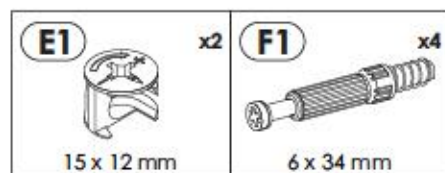

25▶

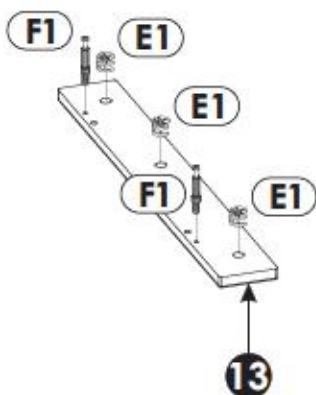
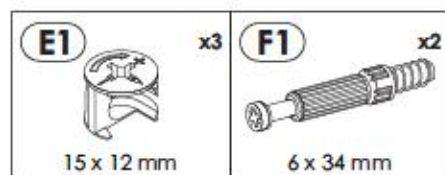

26▶

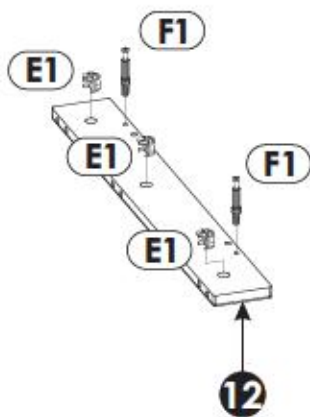
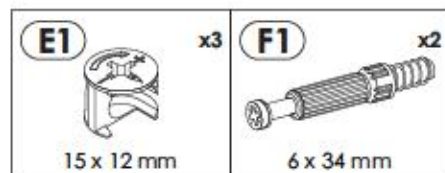

27▶

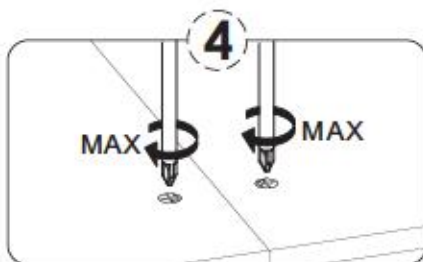
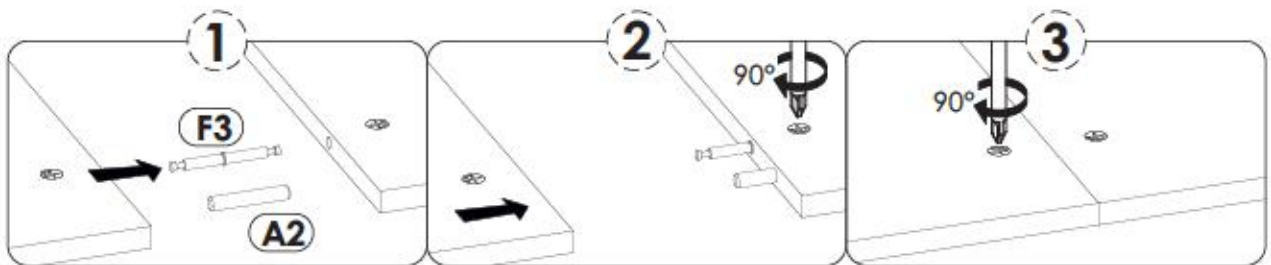
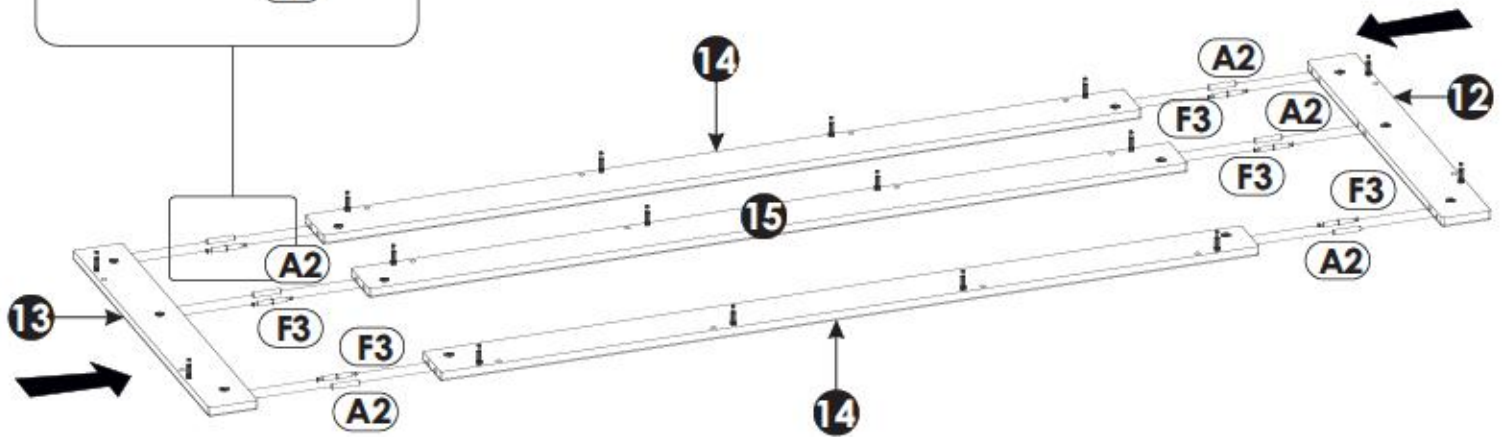
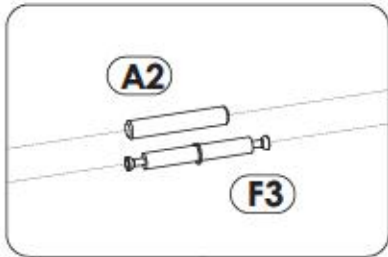
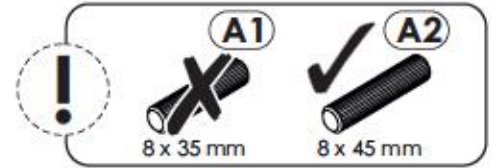
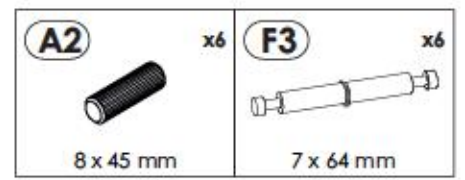
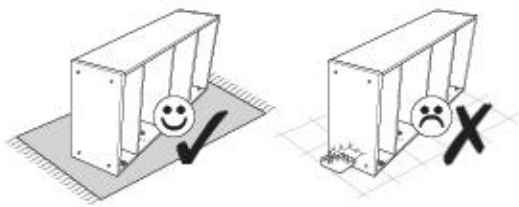

28 ▶

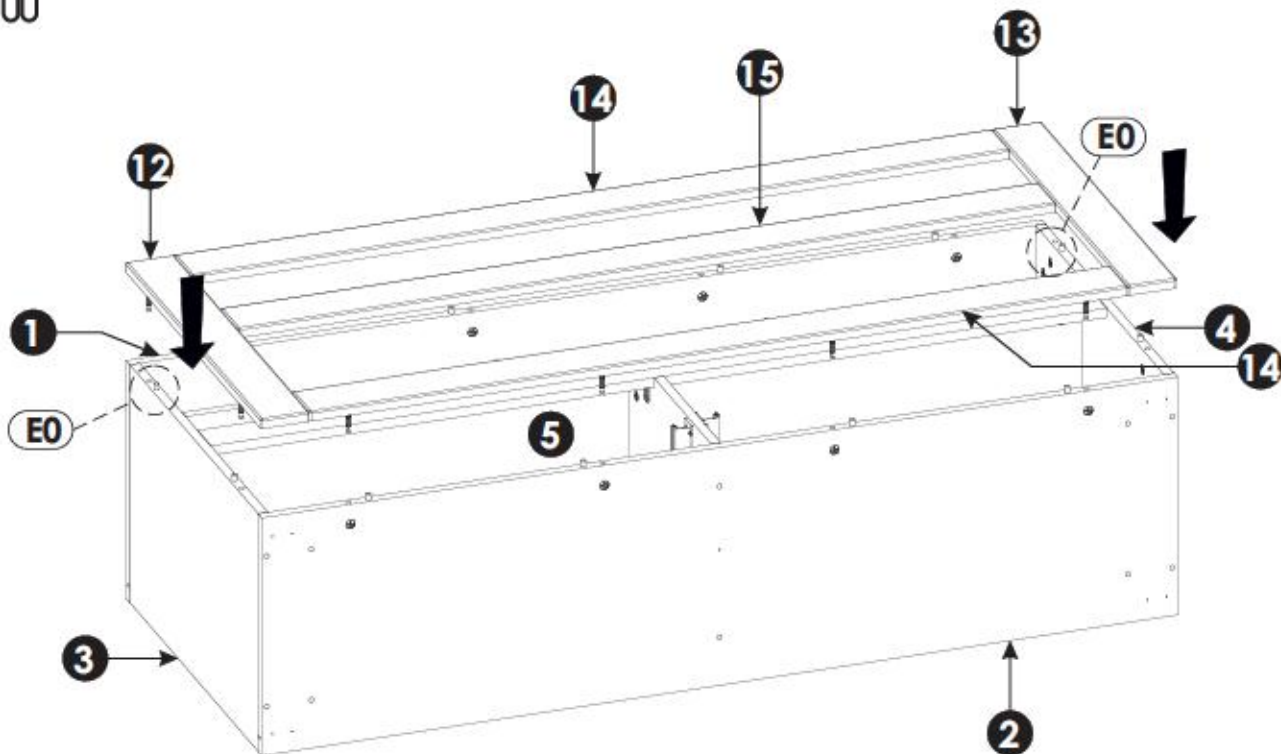
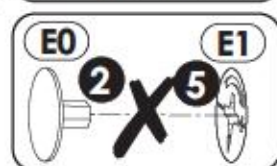
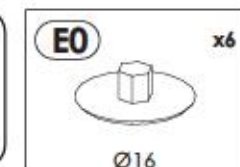
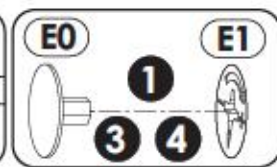
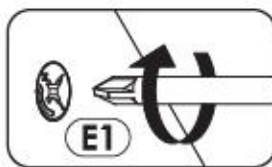

29 ▶

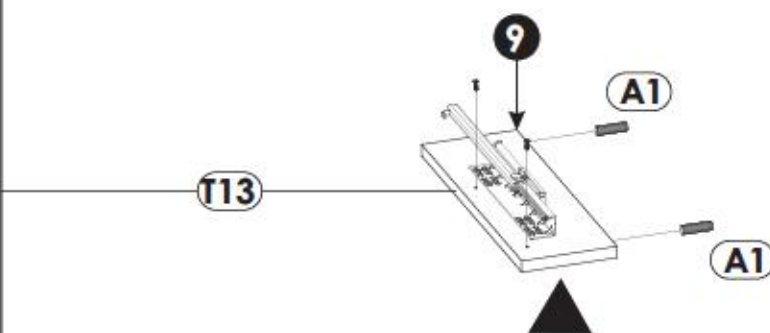
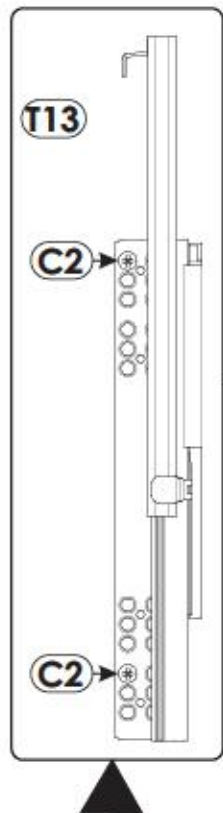
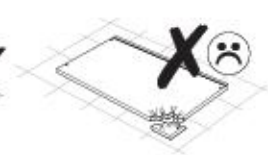
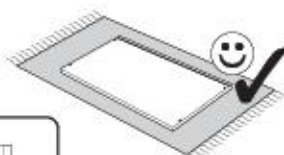

30 ▶

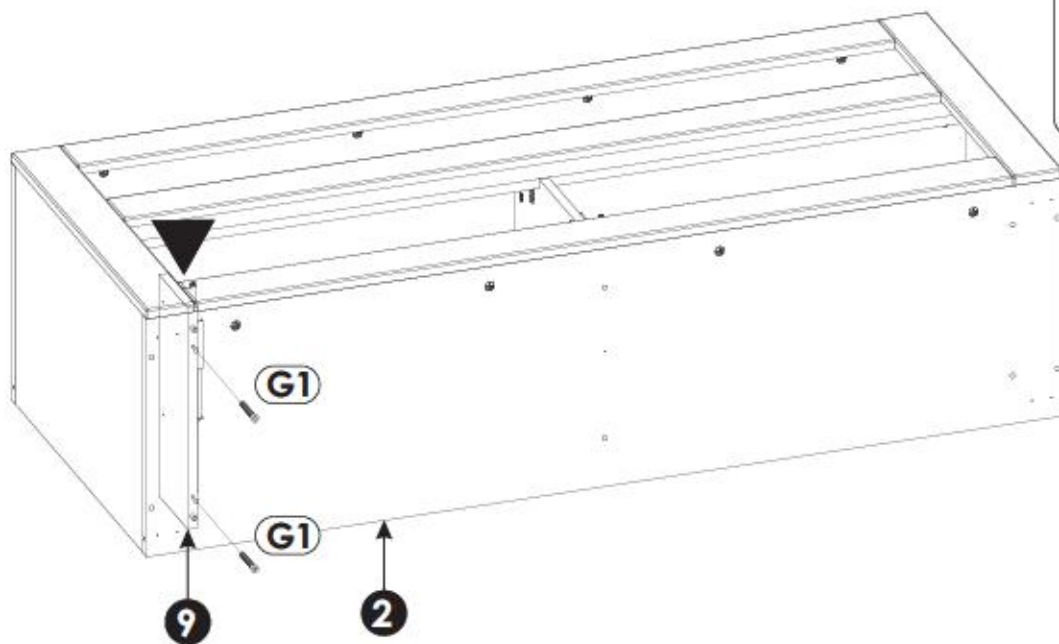
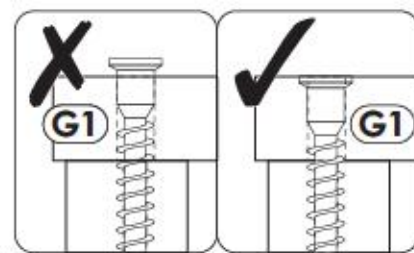
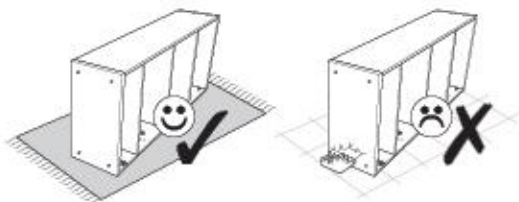

31 ▶

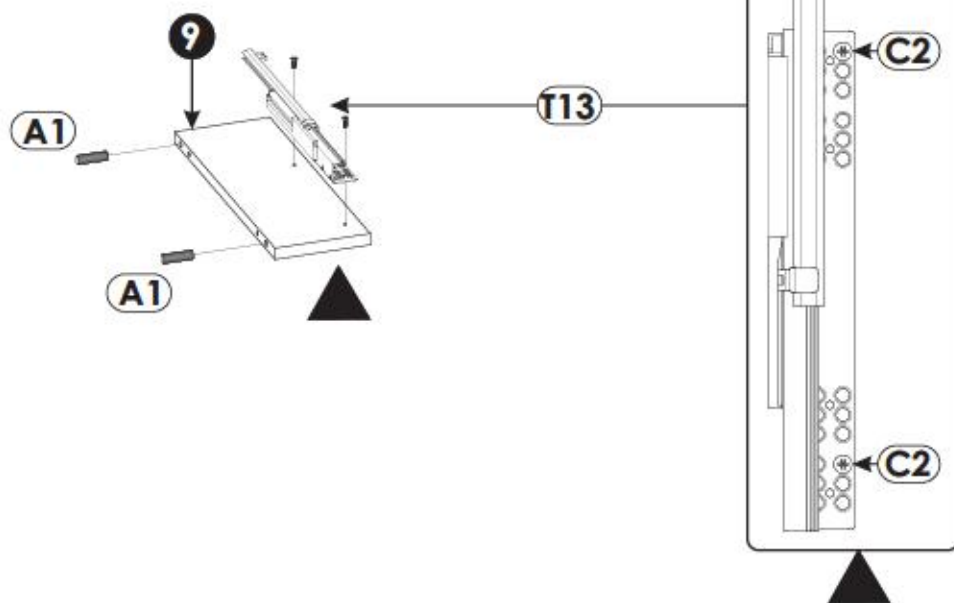

32 ▶

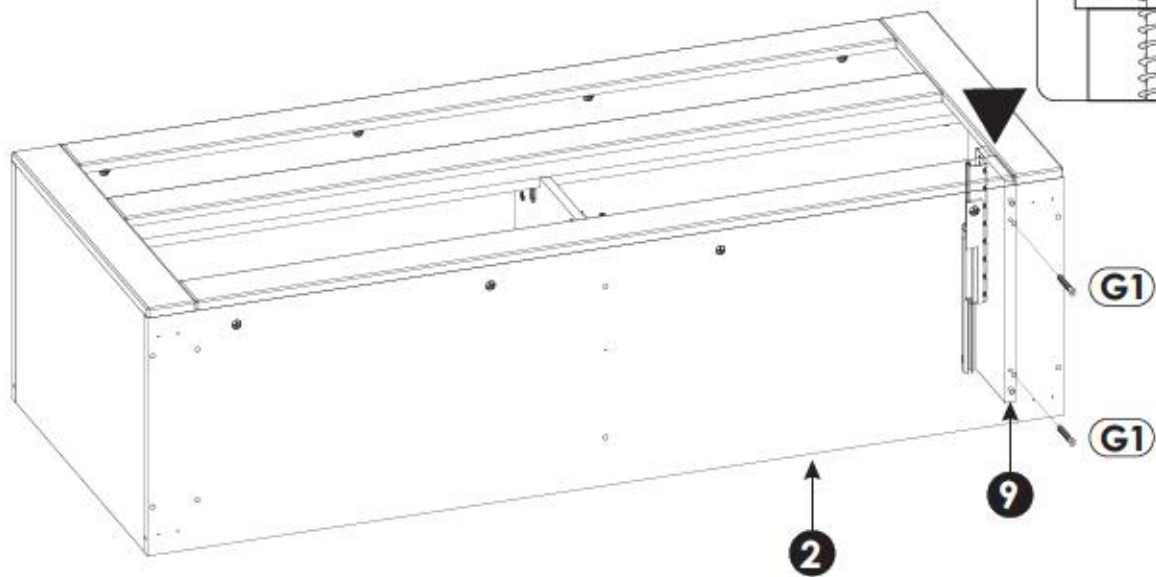
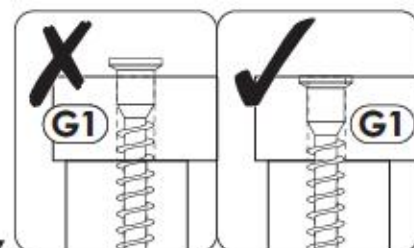
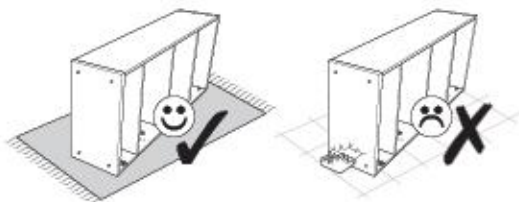

33 ▶

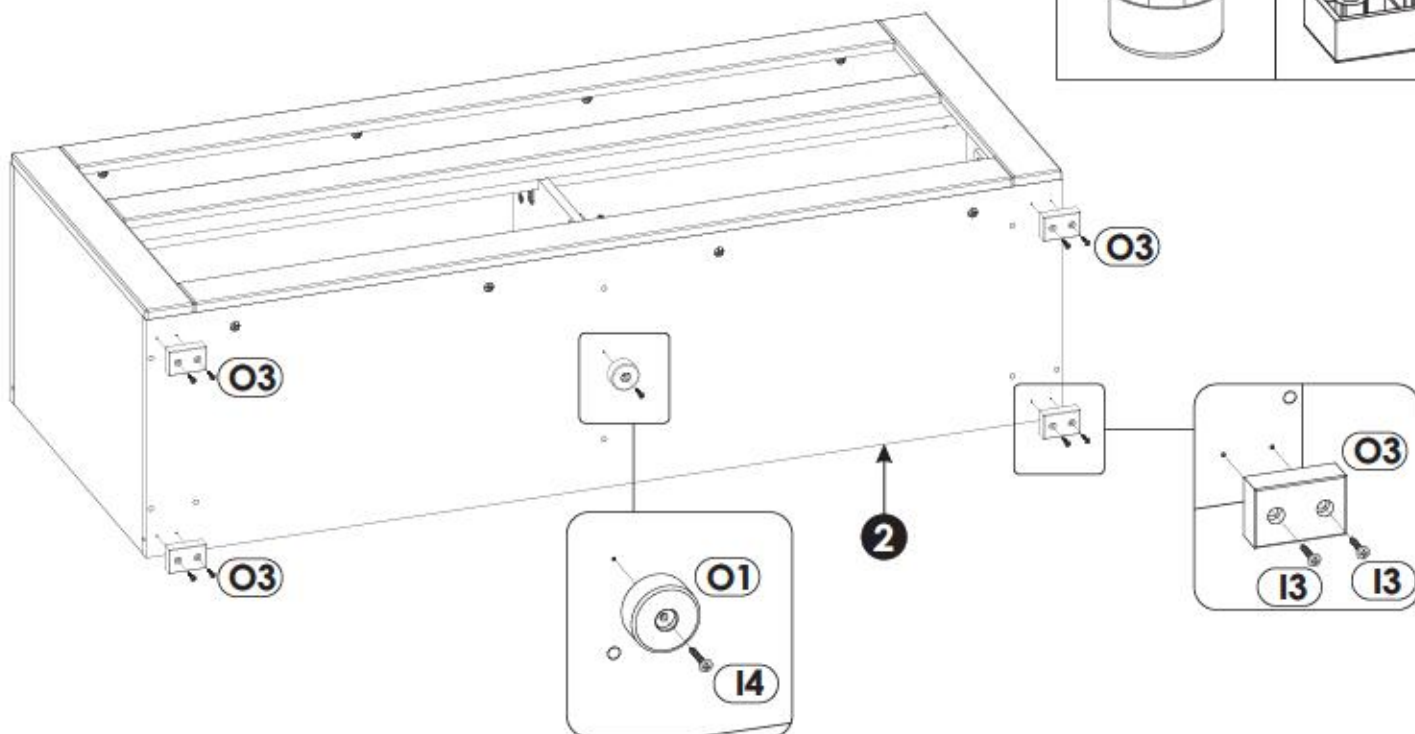
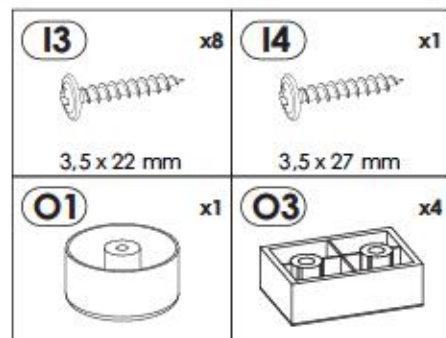
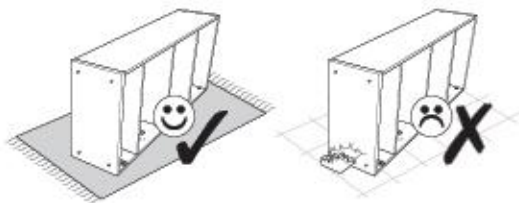

34▶

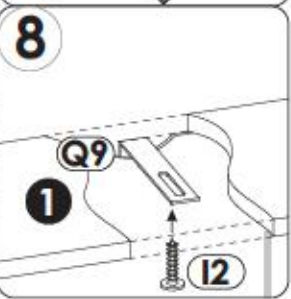
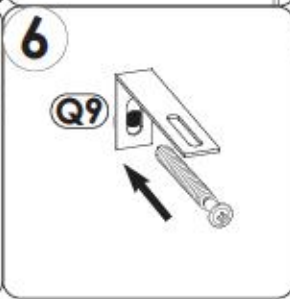
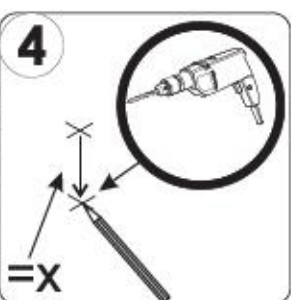
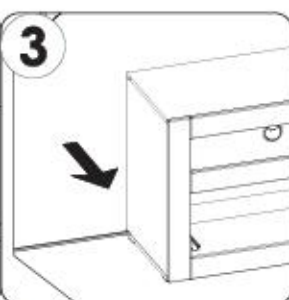
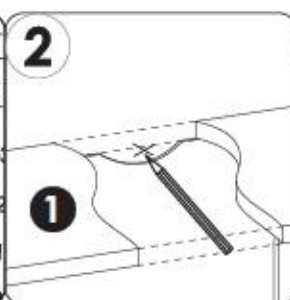
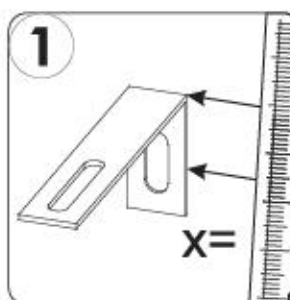
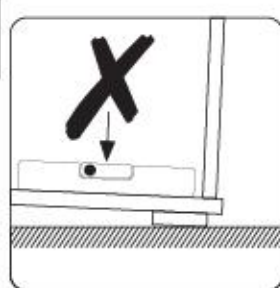
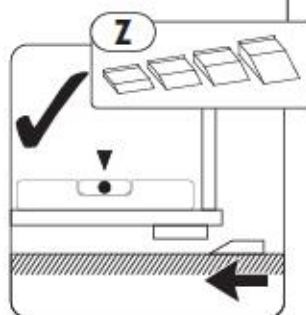
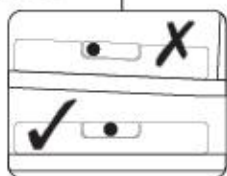
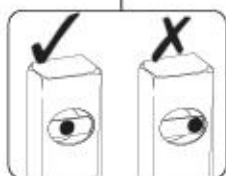
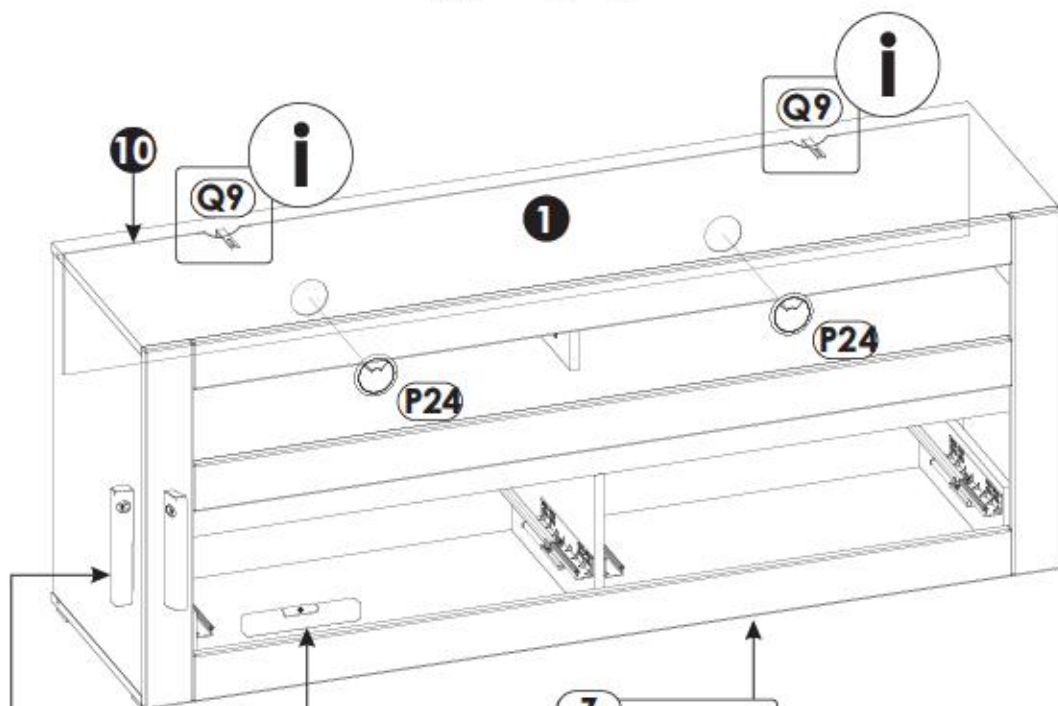
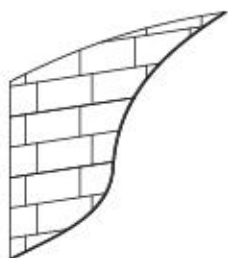
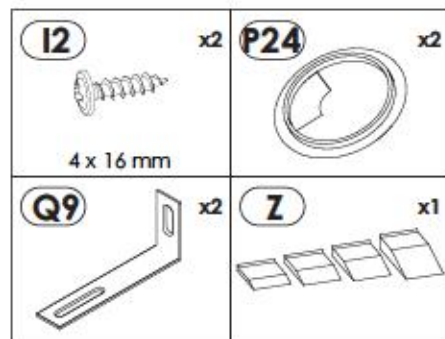
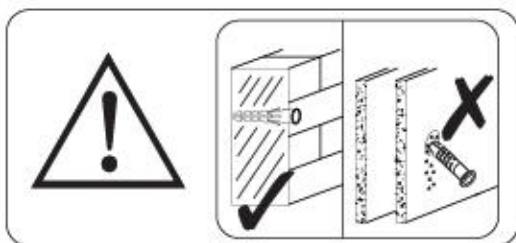

35▶

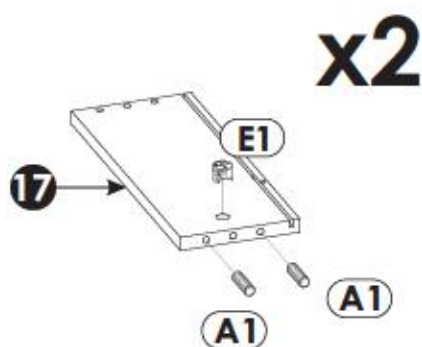

36▶

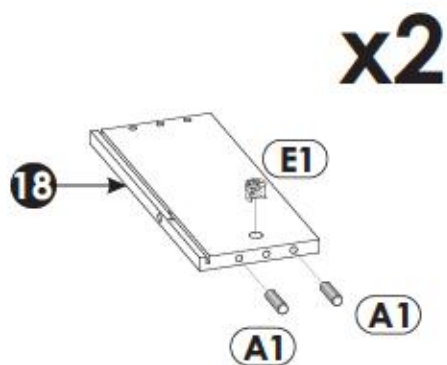
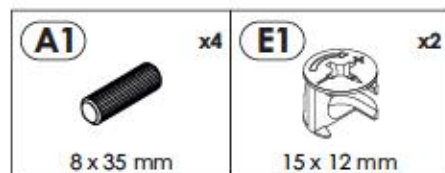

37▶

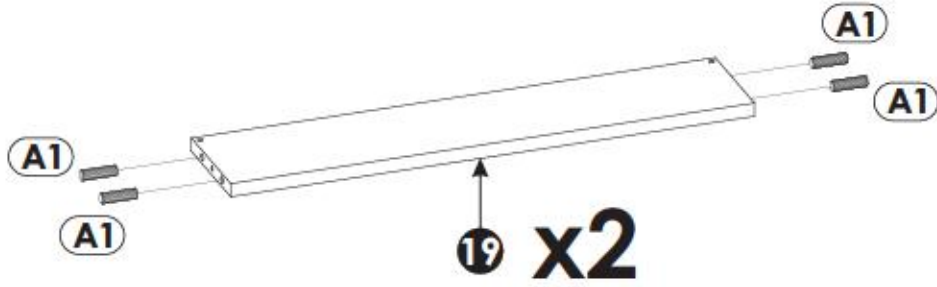
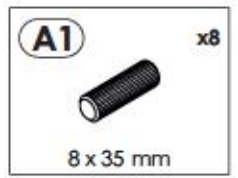

38▶

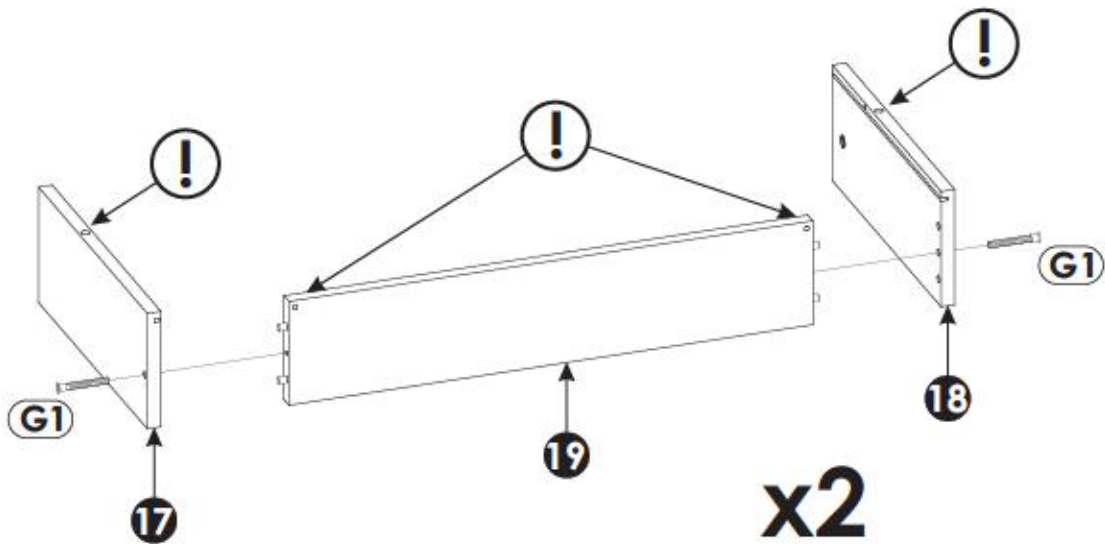
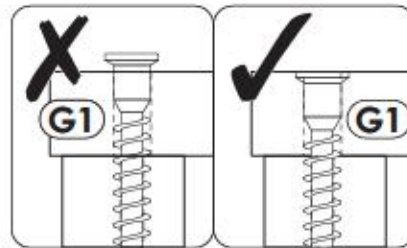
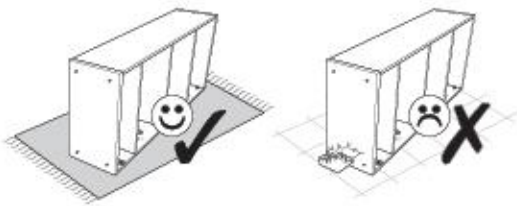

39 ▶

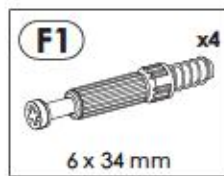
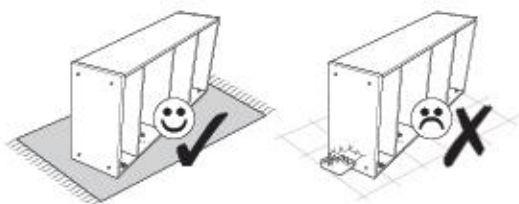

6 x 34 mm

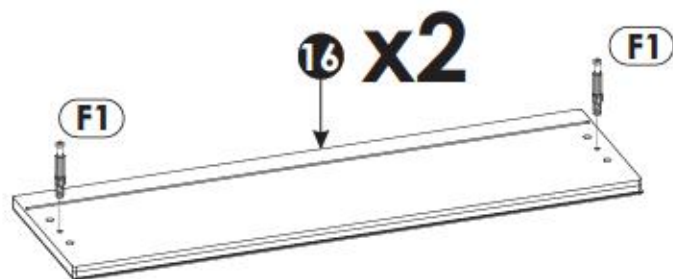

40 ▶

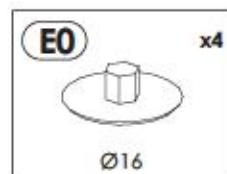
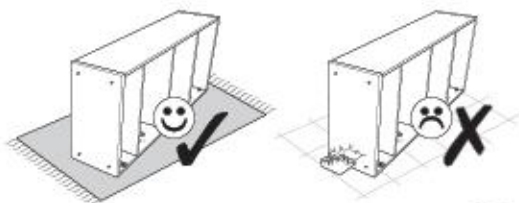

Ø16

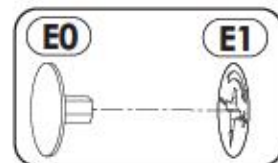
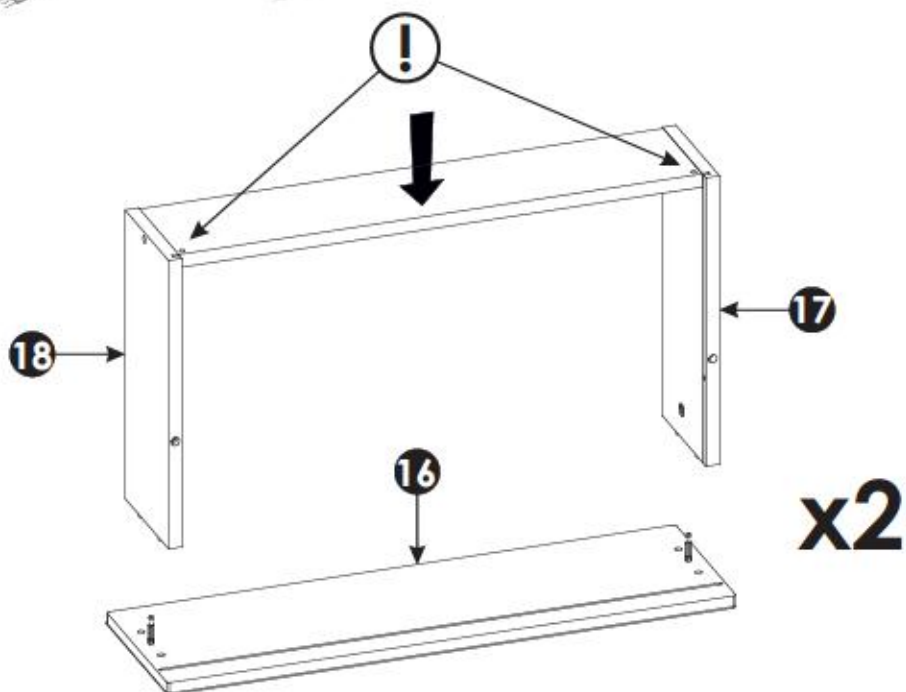

41 ▶

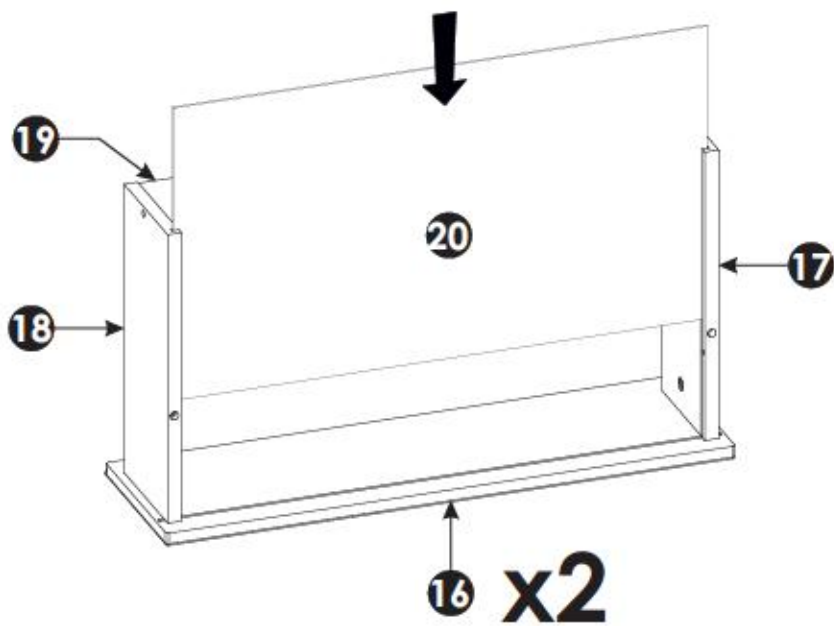
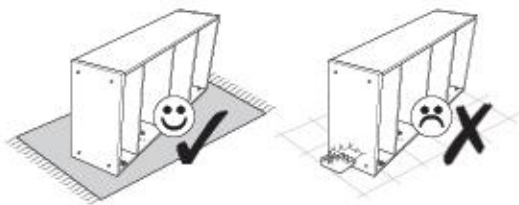

42 ▶

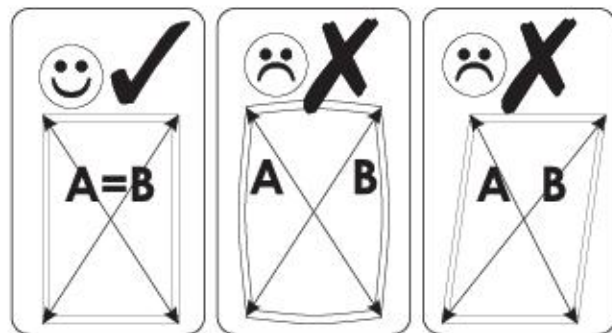
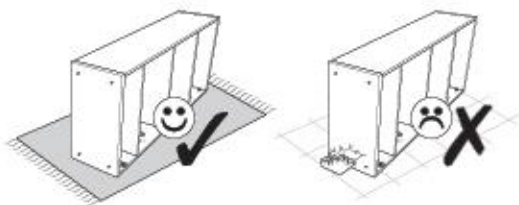

A=B

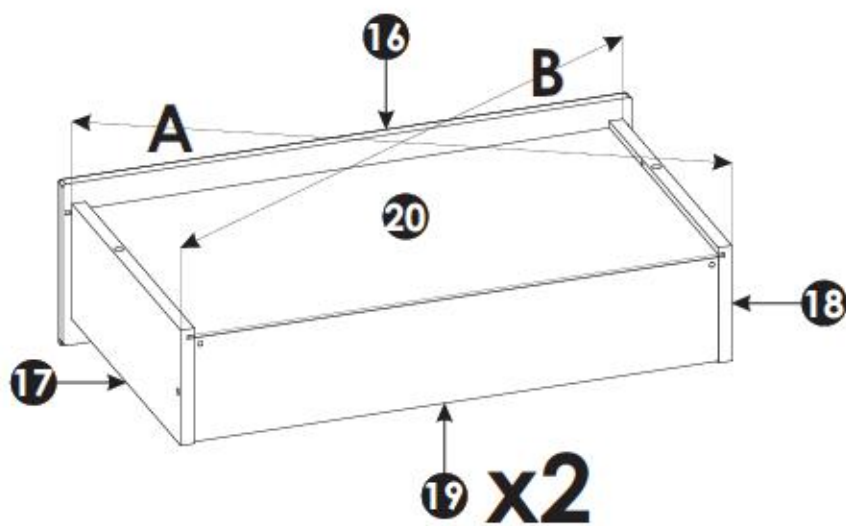

43▶

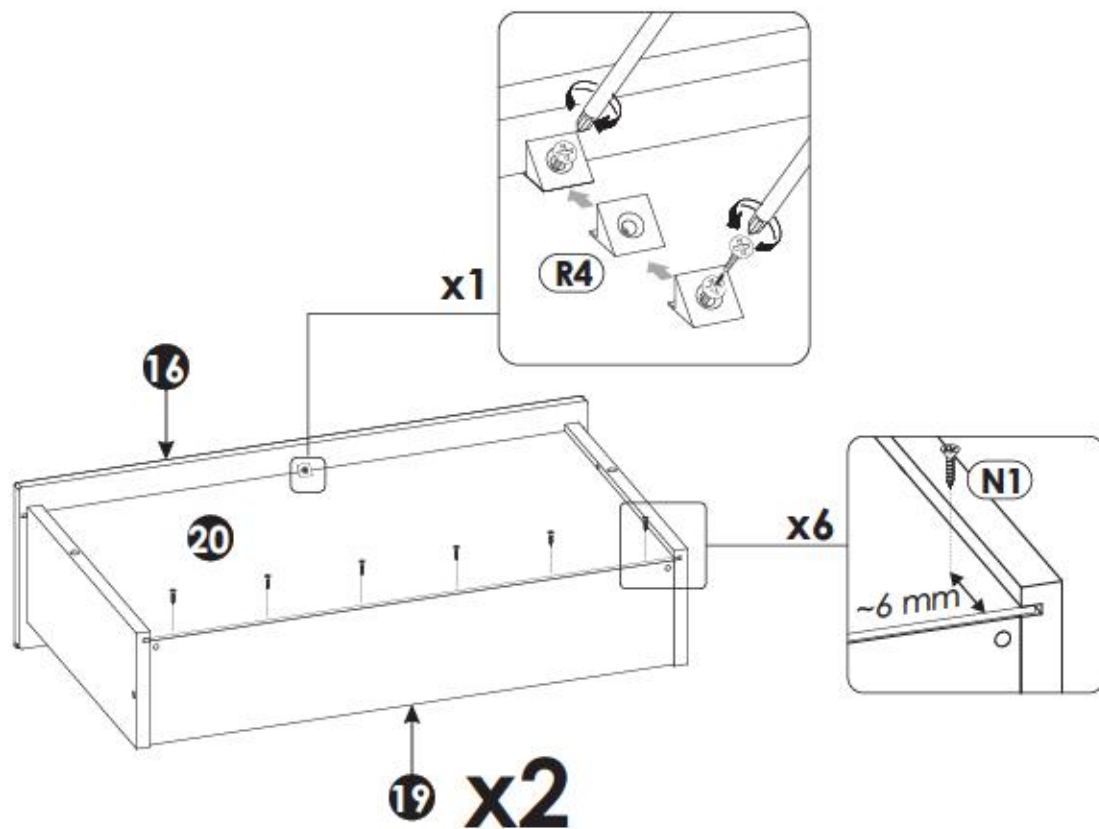
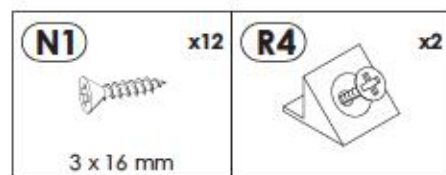
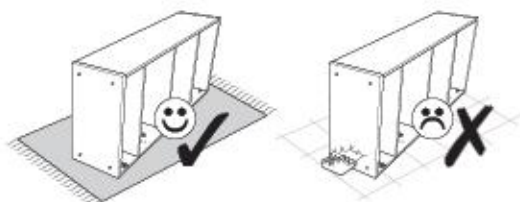

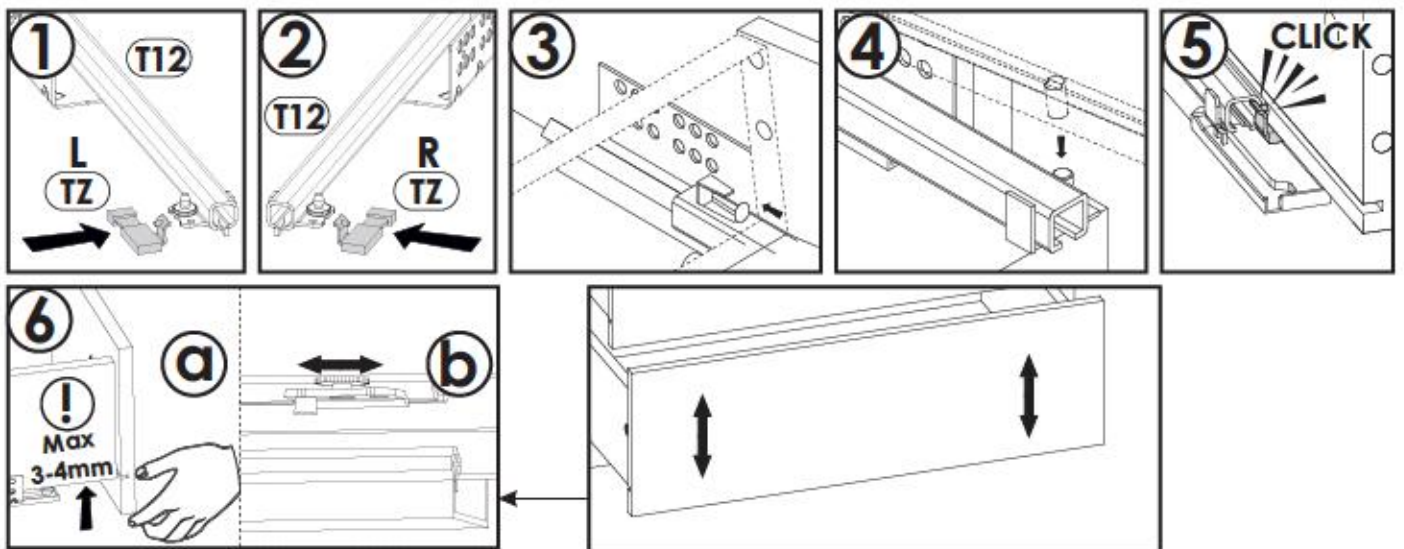
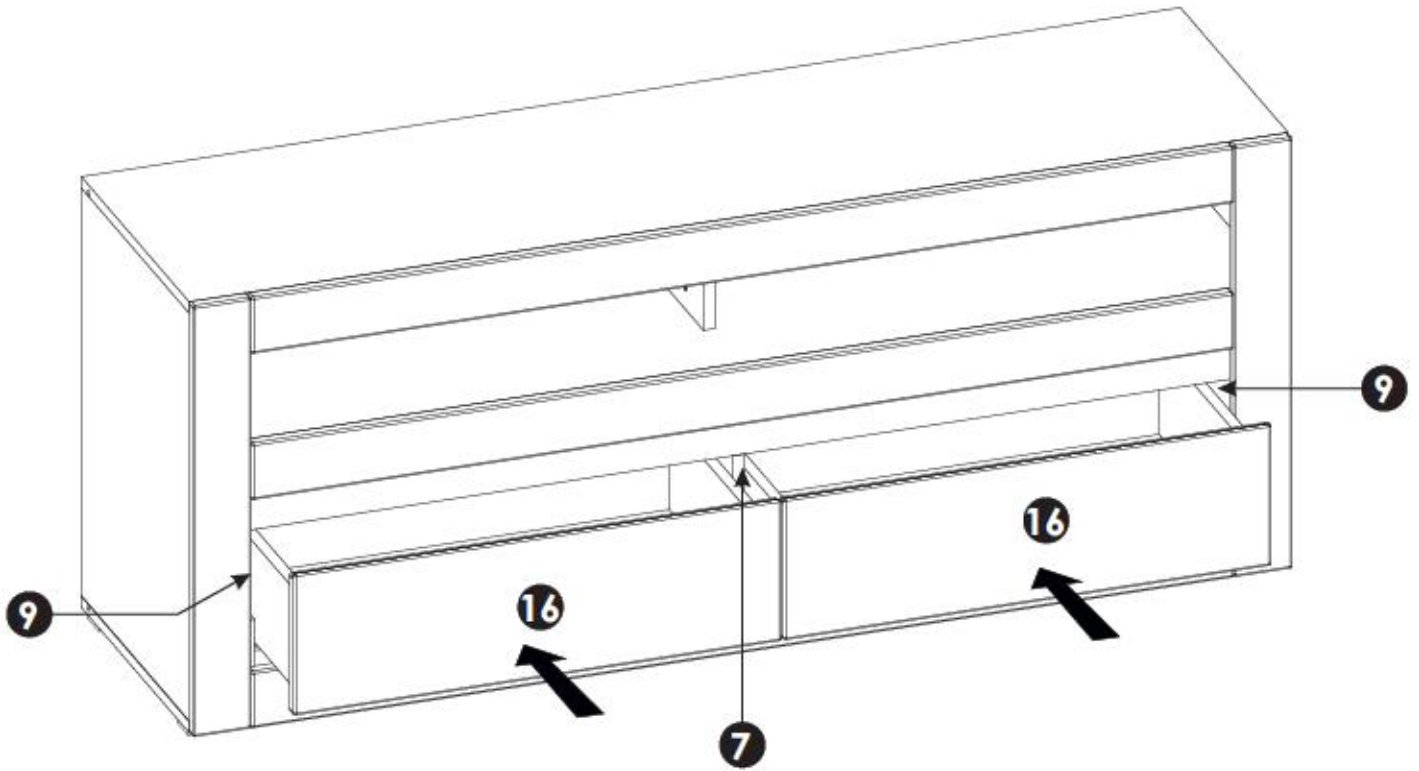
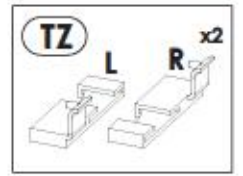

45▶

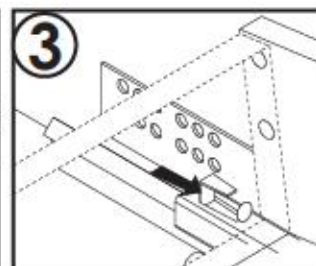
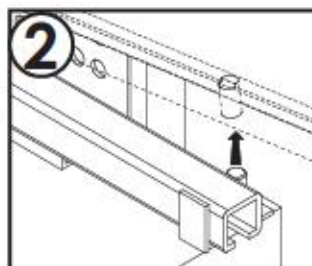
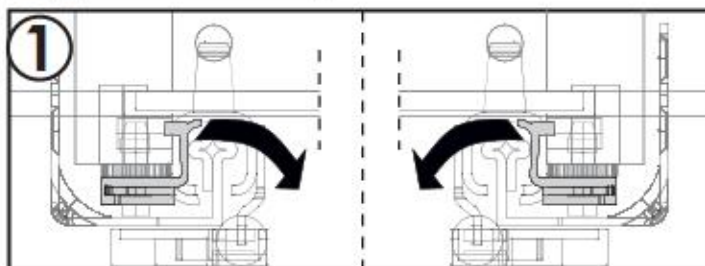
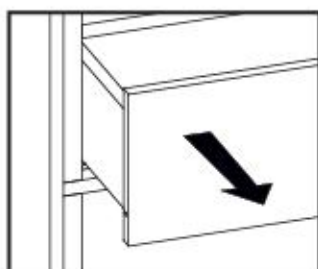
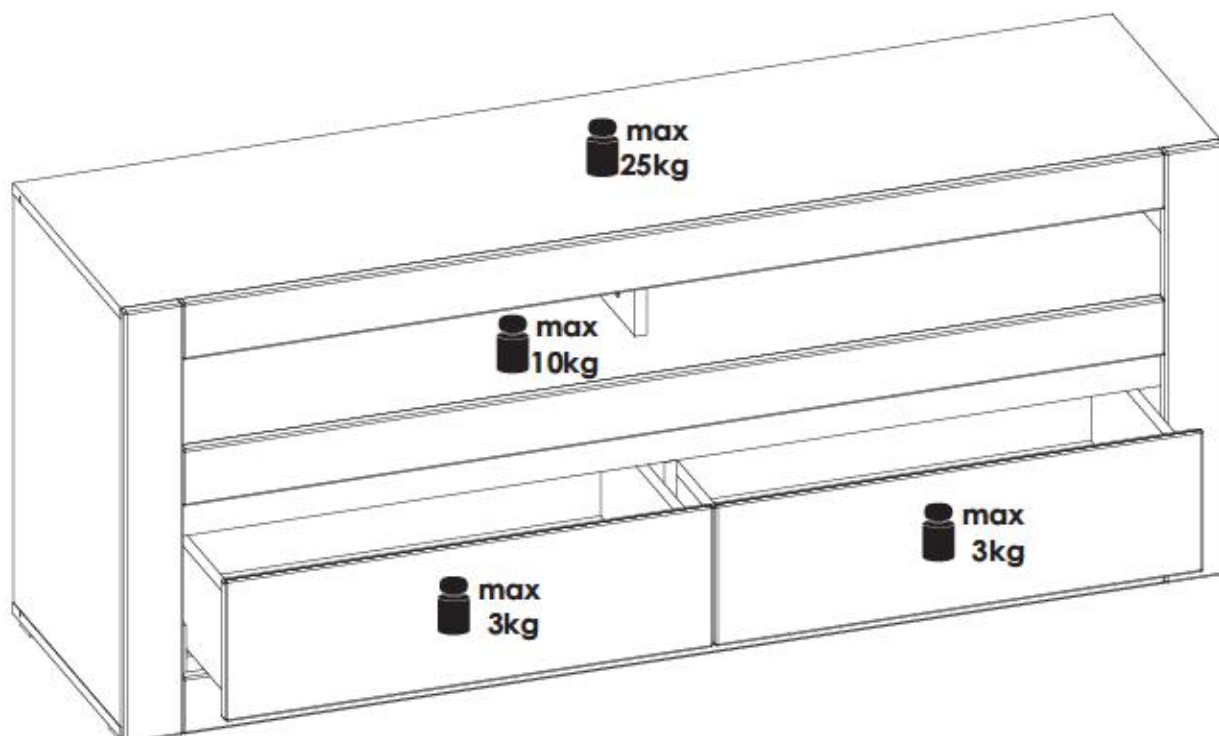

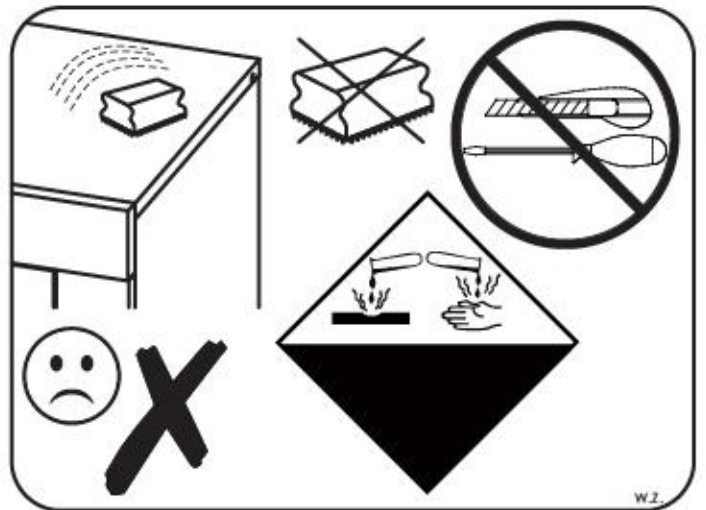
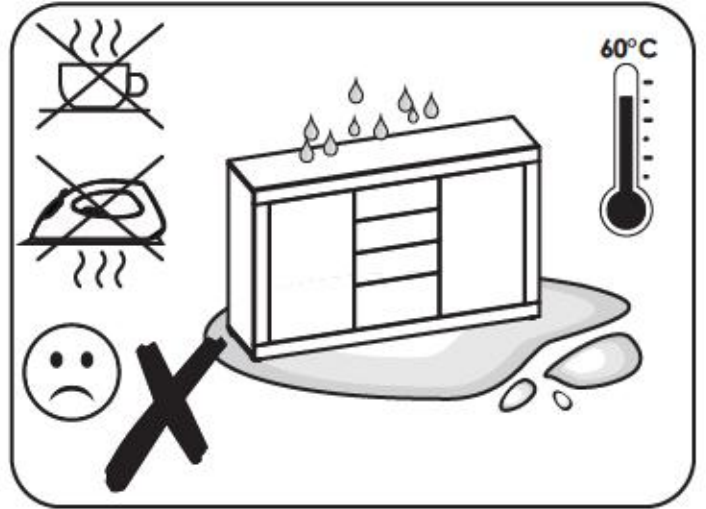
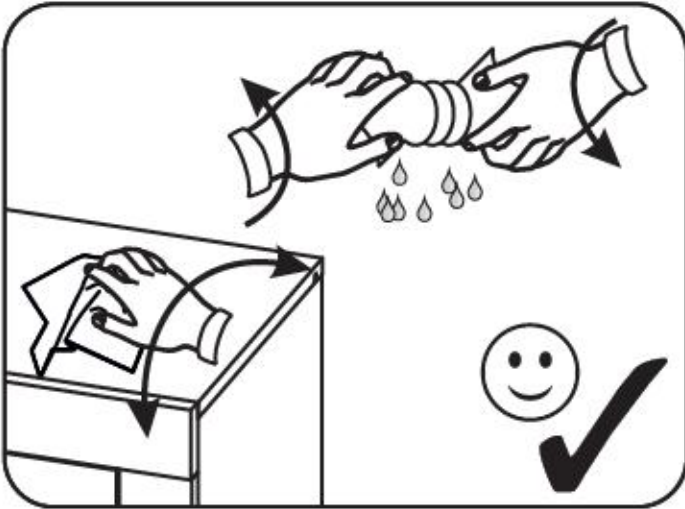
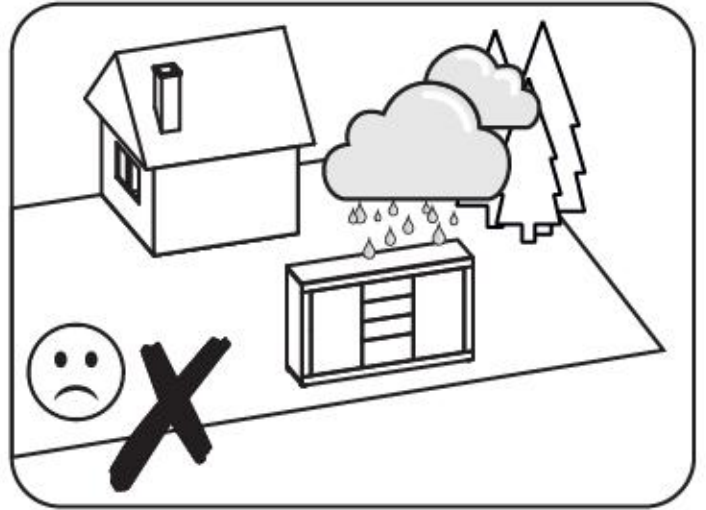
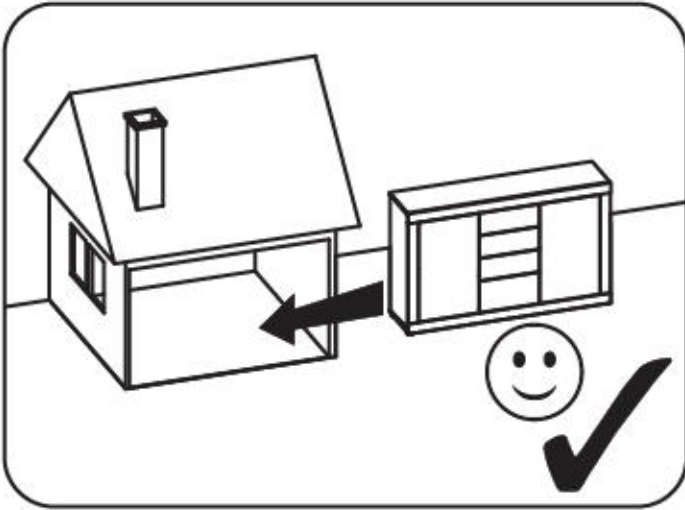

245FCA42

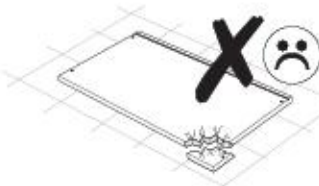
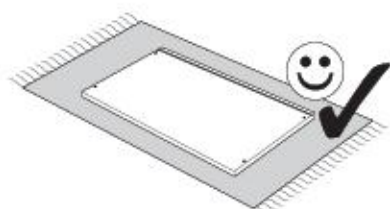
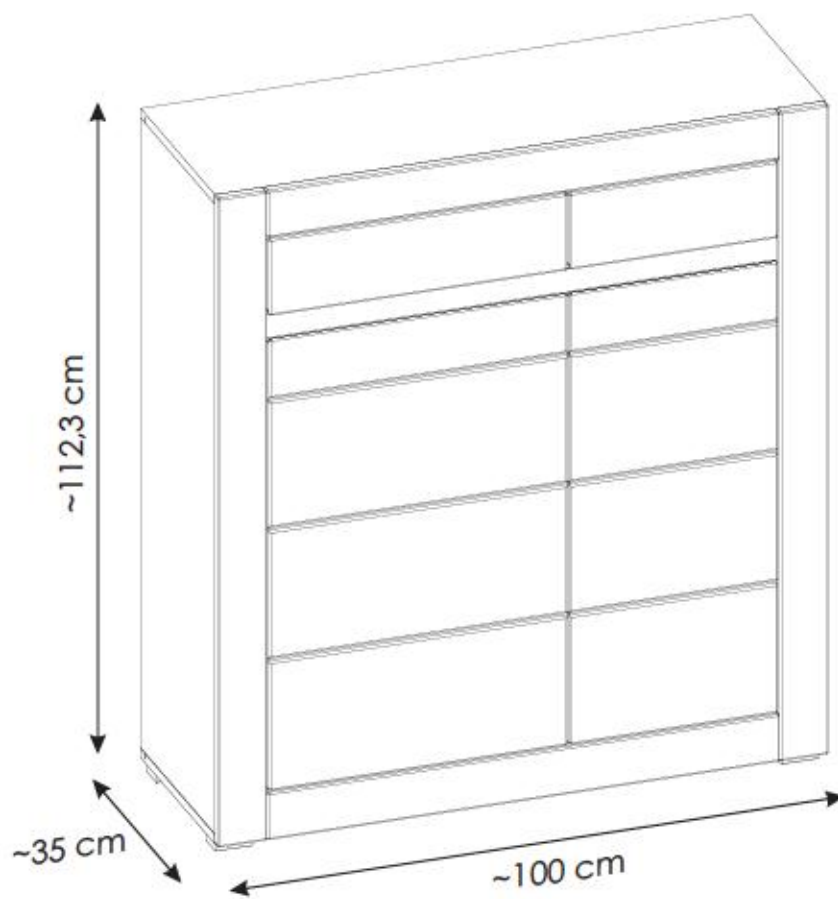
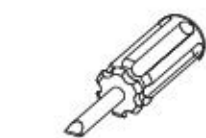

ملاحظة!

يجب تثبيت الأثاث بإحكام إلى الحائط أو الجدار لتجنب خطر إنقلابه. لا تحتوي العلبه على مسامير التثبيت، إذ إنه ينبغي إستعمال المسامير المخصصة لنوعية الحائط أو الجدار. اختر المسامير التي تناسب جدارك.

E.

¡ATENCIÓN! El mueble debe ser fijado permanentemente a la pared para evitar el riesgo relacionado con el vuelco del mueble. En el paquete no hay tornillos de fijación, ya que se debe elegir el tipo de fijación adecuado para el tipo de pared. Elija el apropiado para su tipo de pared.

CN.

注意！本家具需要固定在墙上以免倒塌。箱子里没有安装螺钉。因为安装方式需要根据墙的类型调整。请按照您的墙类型选择合适的安装方式。

SLO.

POZOR! Pohišivo trajno pritrđite na steno, da preprečite tveganje, da se prevrne. V paketu ni pritrđilnih vijakov, saj je treba način pritrđitve ustrezno izbrati glede na vrsto stene. Izberite način, ki je ustrezen za vašo steno.

HU.

FIGYELEM! Rögzítse a bútorokat a falhoz, hogy elkerülje a bútor felborulásának kockázatát. A készletben nem találhatóak rögzítőcsavarok, mivel a rögzítés típusa a fal típusától függ. Válassza ki a fal típusának megfelelő kötőelemeket.

NL.

OPMERKING! De meubelen moeten permanent aan de muur worden bevestigd om te voorkomen dat de meubelen kantelen. Er zitten geen bevestigingsschroeven in het pakket, omdat het type bevestiging moet worden gekozen op basis van het type muur. Kies de juiste voor uw type muur.

EN.

WARNING! To prevent this furniture from tripping over, fix it to the wall permanently. Fixing devices are not included since different wall materials require different types of fixing devices. Please make sure you chose the correct ones for your type of wall.

SK.

POZORI Nábytok musí byť trvalo pripevnený k stene tak, aby sa zamedzilo riziku prevrátenia. Balík neobsahuje upevňovacie skrutky, pretože typ upevnenia je treba vybrať podľa typu steny. Vyberte typ vhodný pre Vašu stenu.

CZ.

POZORI Nábytek je nutné pevně připevnit ke zdi, abychom se vyhnuli riziku spojenému s jeho převrnutím. Součástí balení nejsou připevňovací šrouby, protože způsoby připevnění je nutné zvolit podle druhu stěny. Vyberte správný pro Váš typ stěny.

RU.

ПРИМЕЧАНИЕ! Эту мебель необходимо всегда прикреплять к стене, чтобы избежать рисков, связанных с переворотом мебели. В пакете нет крепежных винтов, потому что тип крепления должен быть выбран в соответствии с типом стены. Выберите, пожалуйста, правильные винты к вашей стене.

RO.

ATENȚIE! Mobila trebuie ancorată permanent în perete pentru a evita riscul de răsturnare a mobilei. În pachet nu sunt incluse șuruburile de fixare, deoarece tipul de ancoraj trebuie ales în funcție de tipul de perete. Alegeți șuruburile potrivite pentru tipul Dvs. de perete.

TR.

DIKKAT! Devrimle riskini önlemek için mobilya duvara sabitlenmelidir. Sabitleme civataları pakete dahil değildir, çünkü sabitleme tertibatının tipi, duvara tipine uygun olarak seçilmelidir. Onu duvannızın tipine göre seçiniz.

PL.

UWAGA! Mebel należy trwale zamocować do ściany, aby uniknąć ryzyka związanego z przewróceniem się mebla. W paczce nie ma śrub mocujących, ponieważ rodzaj mocowania należy odpowiednio dobrać do rodzaju ściany. Dobierz właściwe do Twojego rodzaju ściany.

D.

ACHTUNG! Um alle mit dem Umkippen des Möbels verbundenen Risiken auszuschließen, muss das Möbel fest an der Wand verankert werden. Beschläge für die Wandbefestigung sind nicht beige packt, da diese von der jeweiligen Wandbeschaffenheit abhängig sind. Bitte solche Befestigungsschläge wählen, die für die heimischen Wände geeignet sind.

FR.

ATTENTION! Ce meuble doit être fixé en permanence au mur pour éviter les risques de chute. Les vis de fixation ne sont pas livrées car le type de fixation doit être choisi en fonction du type de mur. Sélectionnez les fixations adaptées au mur.

I.

ATTENZIONE! Il mobile deve essere permanentemente fissato alla parete per evitare i rischi derivanti da un ribaltamento del mobile. La confezione non include le viti di fissaggio, in quanto il tipo di fissaggio deve essere scelto in base al tipo di parete. Utilizzare viti appropriate in base al materiale della parete.

HR.

NAPOMENA! Namještaj mora biti trajno pričvršćen za zid, kako bi se izbjegao rizik od njegovog prevrtanja. U paketu nema vijaka za pričvršćivanje, jer se vrsta montaže mora prilagoditi vrsti zida. Odaberite pravu vrstu prema Vašoj vrsti zida.

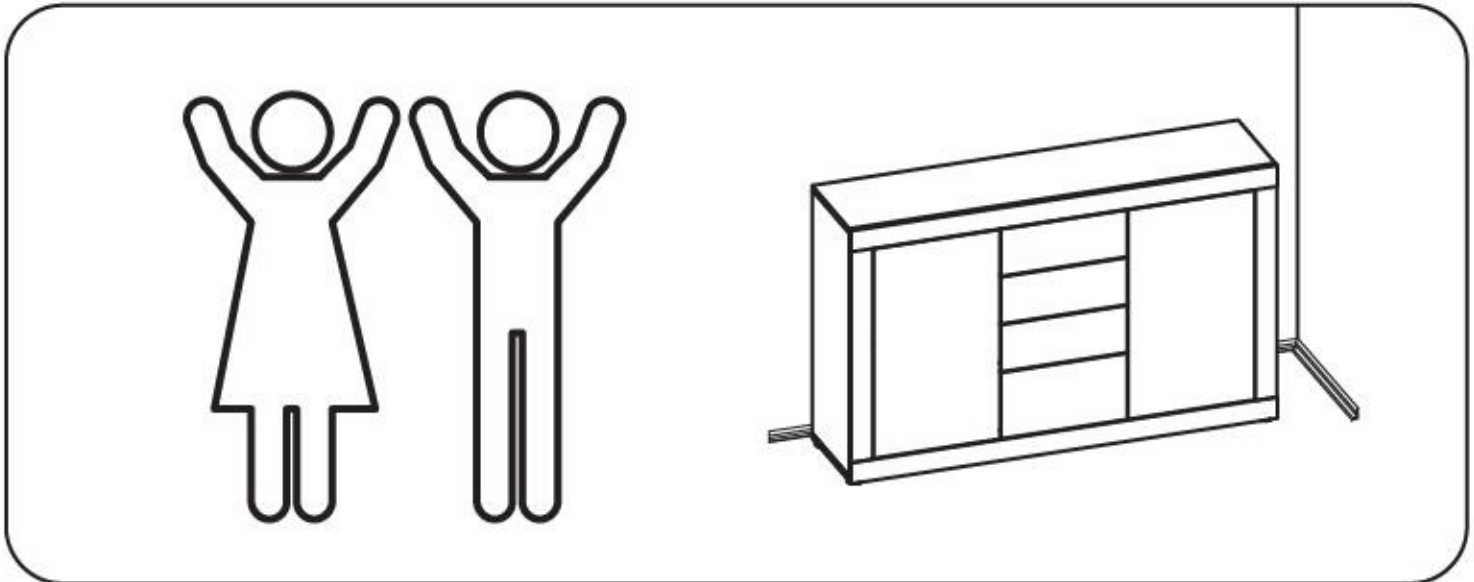
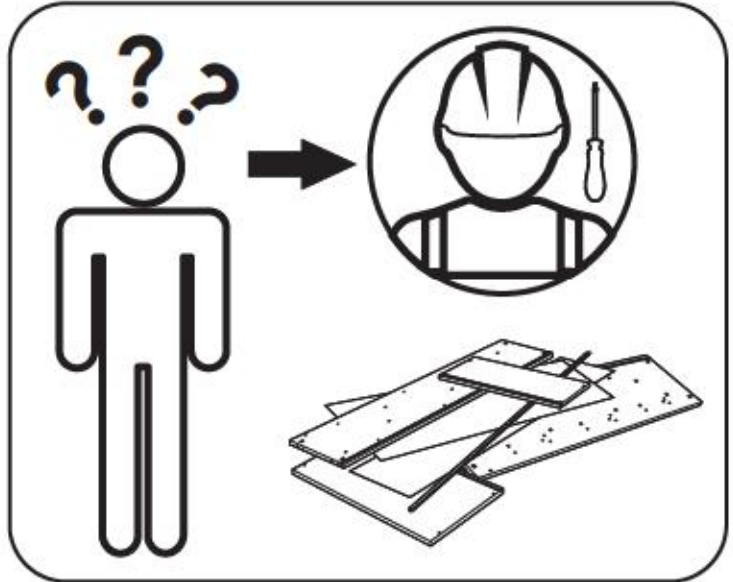
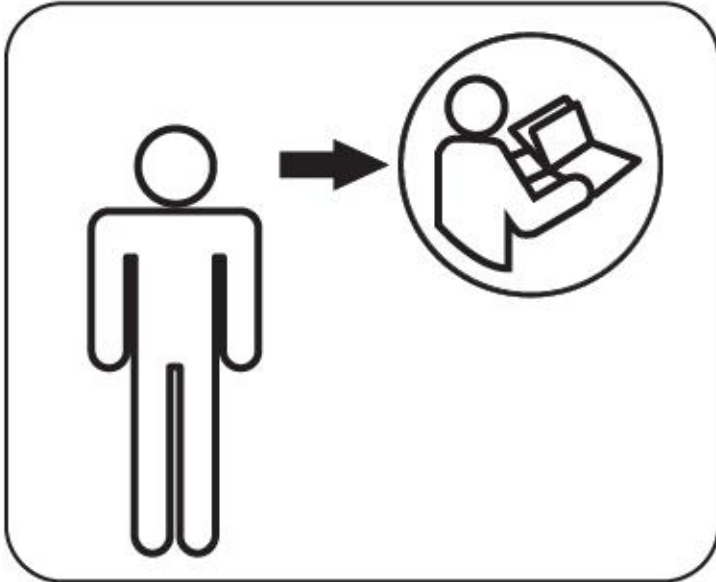
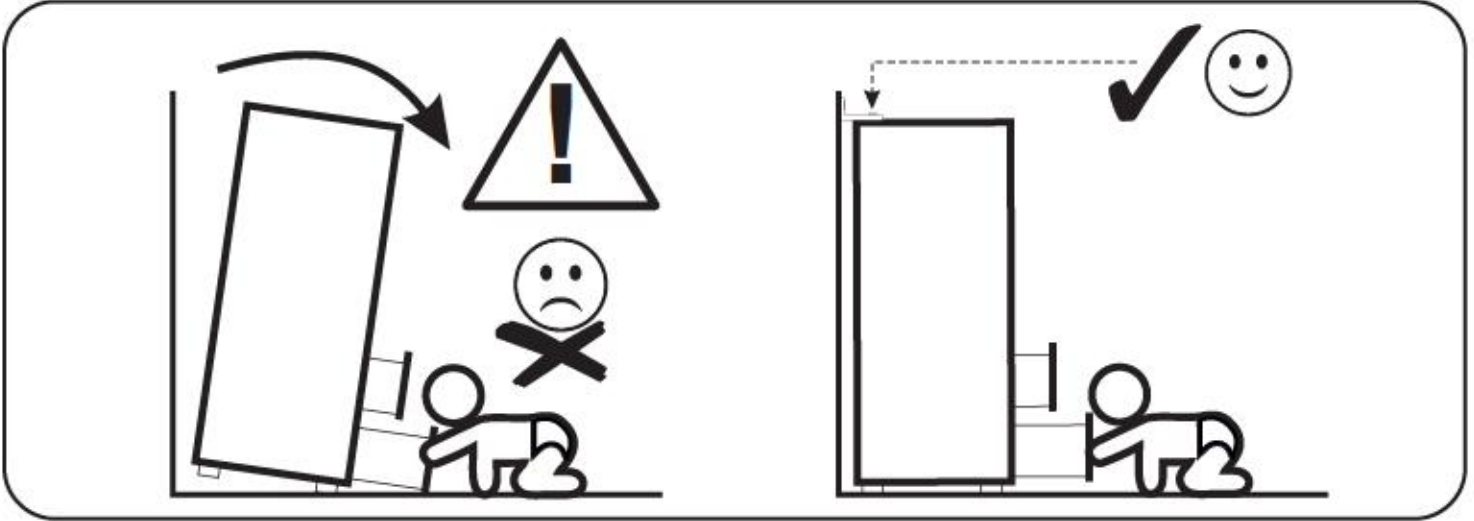
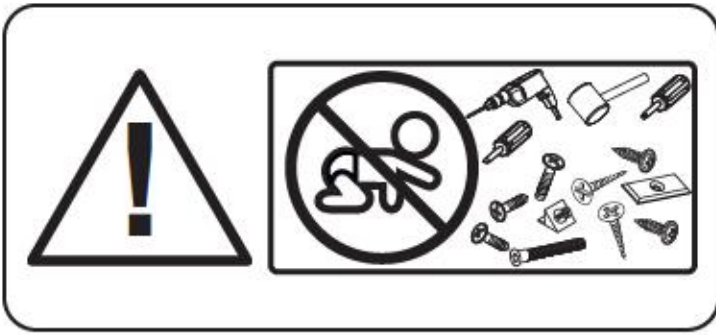



version A

BCxx

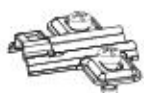

BCxx

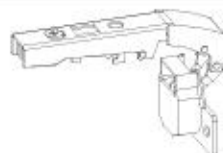

version B

BCxx

+
BCxx

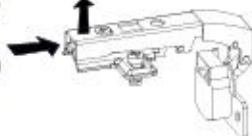



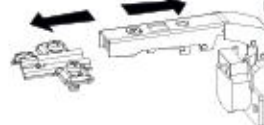





BCxx

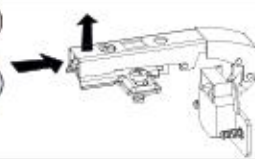

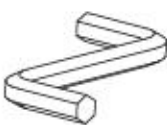
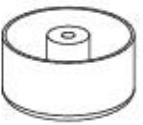
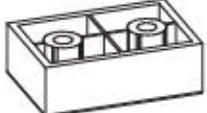
BCxx

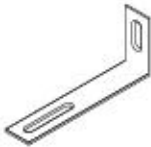
245FCA42

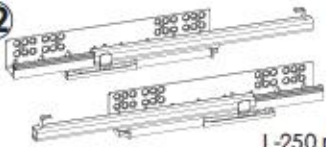
MM

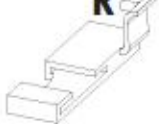
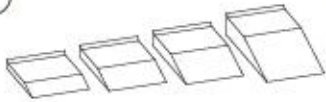
A1	8 x 35 mm	x38	A2	8 x 45 mm	x4	A6	8 x 24 mm	x5
BC17 + BC18		x5	C2	5 x 13 mm	x14	D2		x8
E0	Ø16	x15	E1	15 x 12 mm	x35	F1	6 x 34 mm	x27
F3	7 x 64 mm	x4	G0		x4	G1	7 x 50 mm	x12
I2	4 x 16 mm	x2	I3	3.5 x 22 mm	x8	I4	3.5 x 27 mm	x1
I11	4 x 27 mm	x2	M		x1	N1	3 x 16 mm	x20
N13	4 x 25 mm	x10	O1		x1	O3		x4
P16		x10	Q9		x2	R1		x11
R4		x12	T12		x1	TZ	L  R 	x1
Z		x1	L-250 mm					

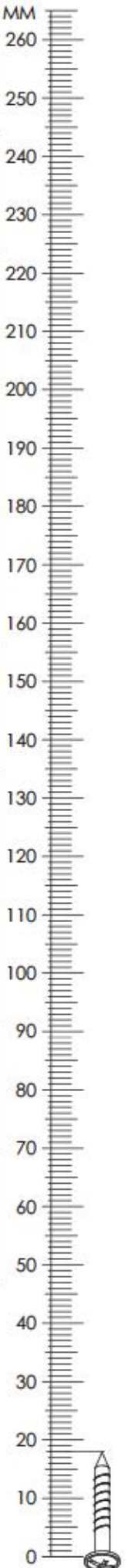
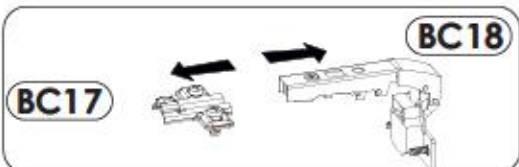

245FCA42

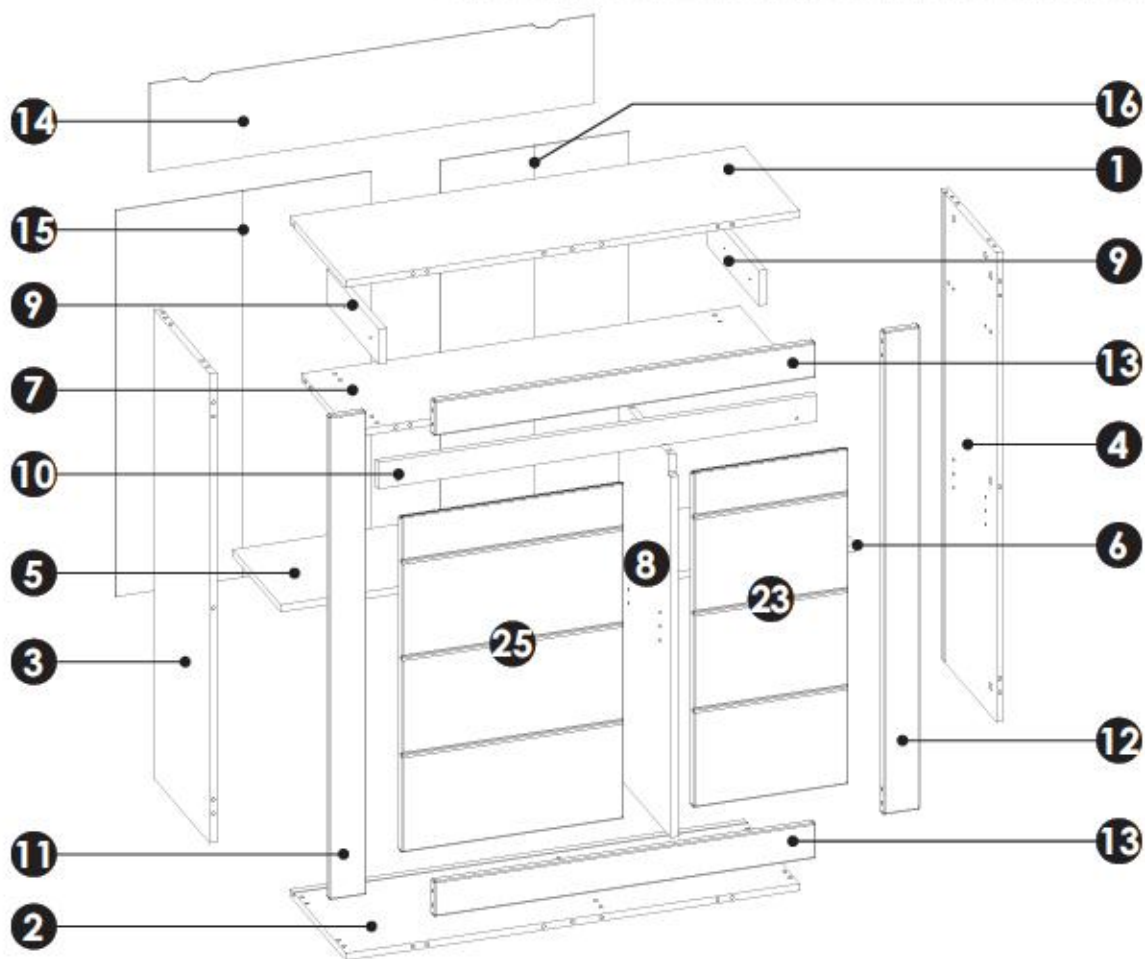
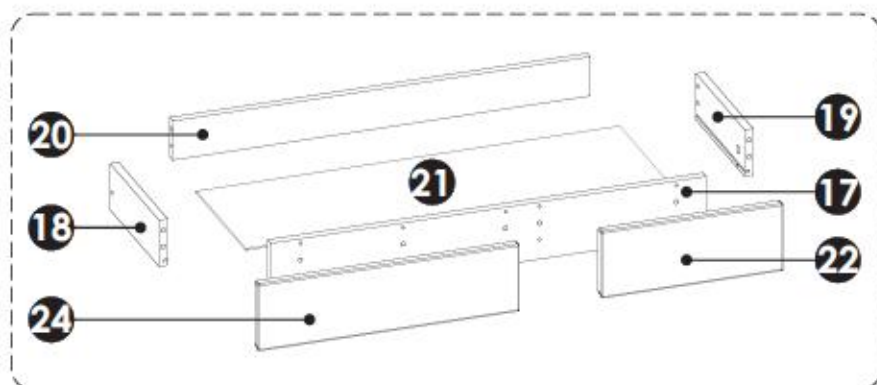

1	1000	334	16	x1	1/2
2	1000	334	16	x1	1/2
3	1071	334	16	x1	1/2
4	1071	334	16	x1	1/2
5	550	298	16	x1	2/2
6	401	298	16	x1	2/2
7	967	298	16	x1	1/2
8	868	314	16	x1	1/2
9	80	314	16	x2	2/2

10	965	60	16	x1	1/2
11	1103	80	16	x1	1/2
12	1103	80	16	x1	1/2
13	840	80	16	x2	2/2
14	981	201	3	x1	1/2
15	564	882	3	x1	1/2
16	882	416	3	x2	1/2
17	815	111	16	x1	2/2
18	250	90	16	x1	2/2

19	250	90	16	x1	2/2
20	781	76	16	x1	2/2
21	793	255	3	x1	1/2
22	341	130	16	x1	2/2
23	341	767	16	x1	2/2
24	490	130	16	x1	2/2
25	490	767	16	x1	2/2

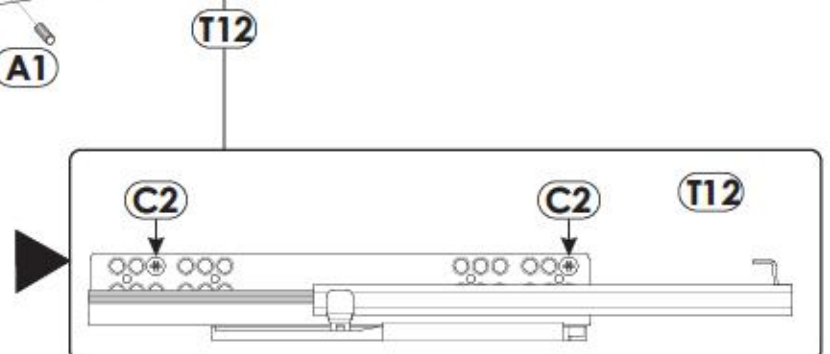
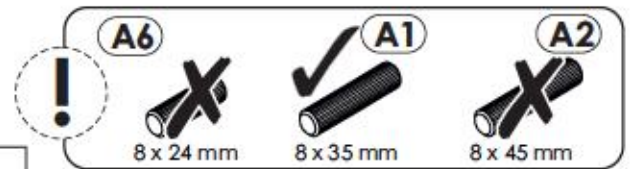
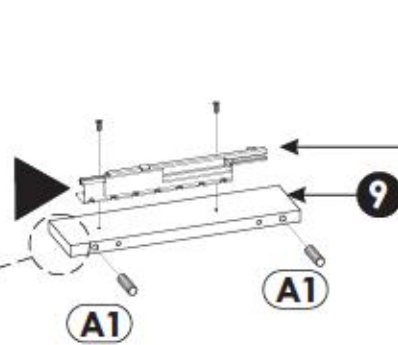
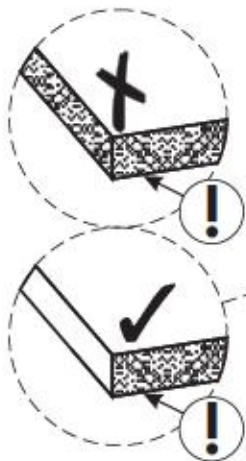
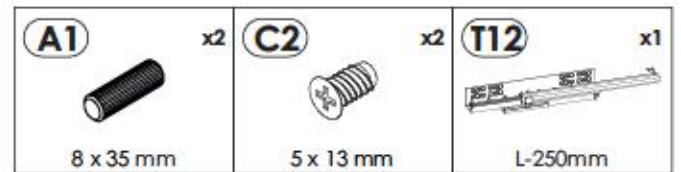
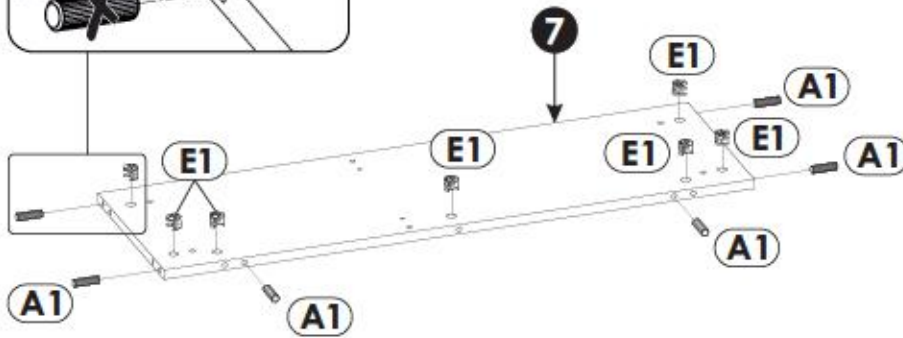
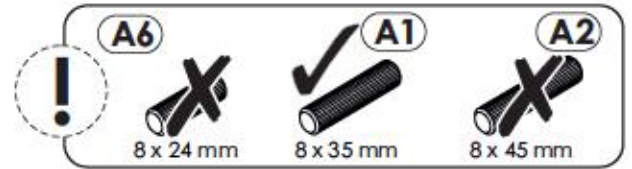
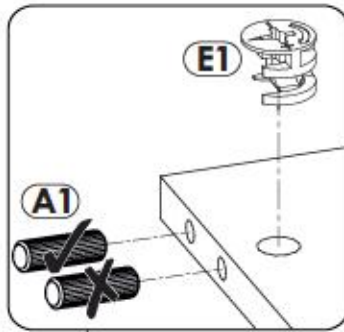
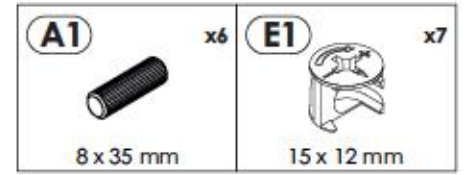
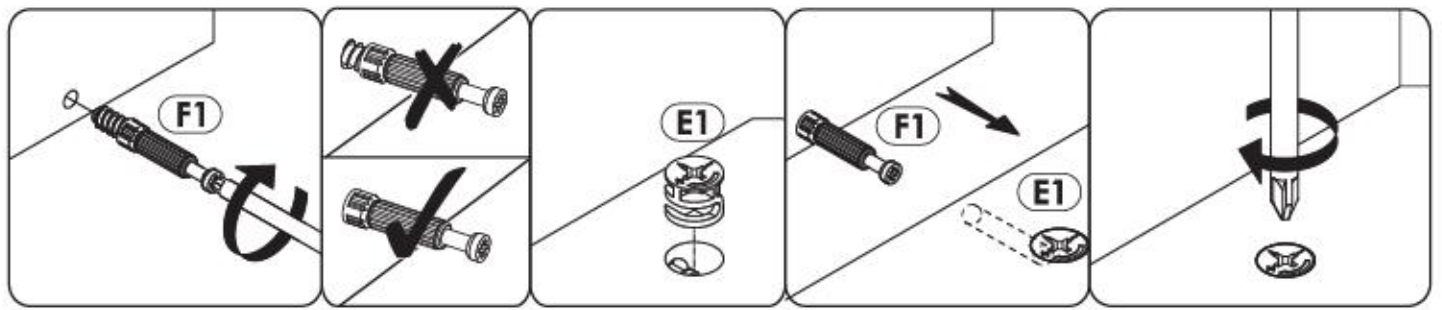

3 ▶

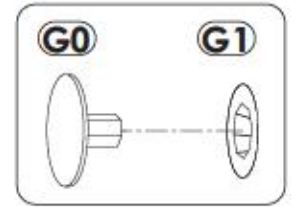
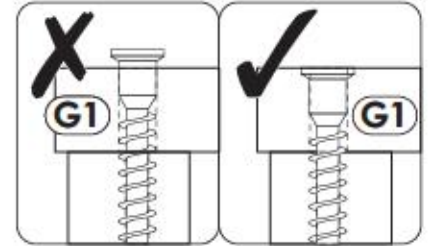
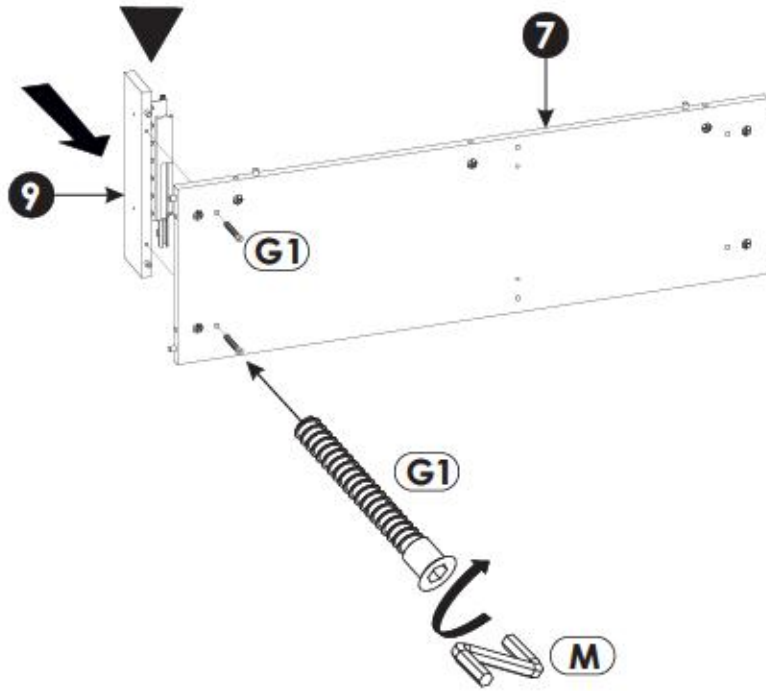
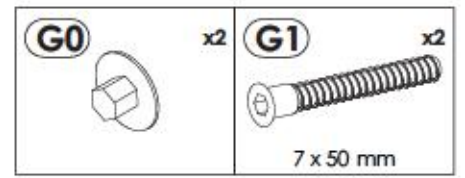
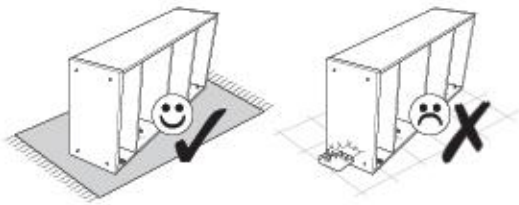

4 ▶

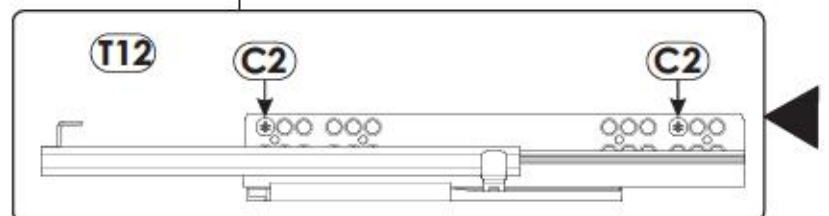
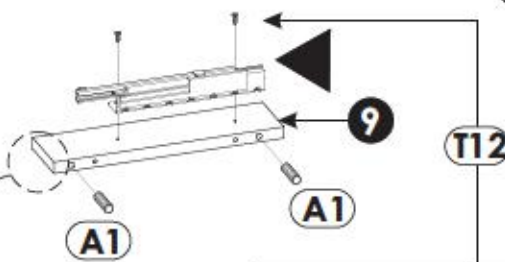
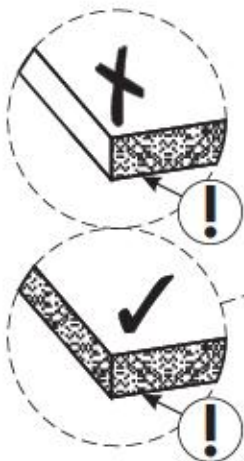
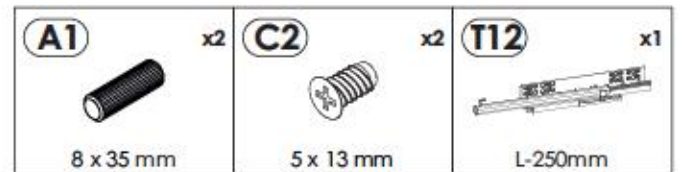

5 ▶

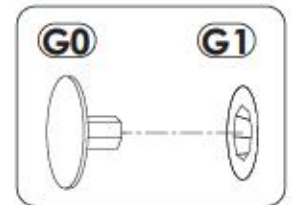
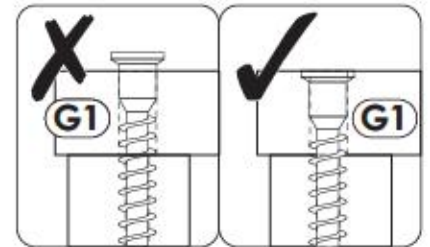
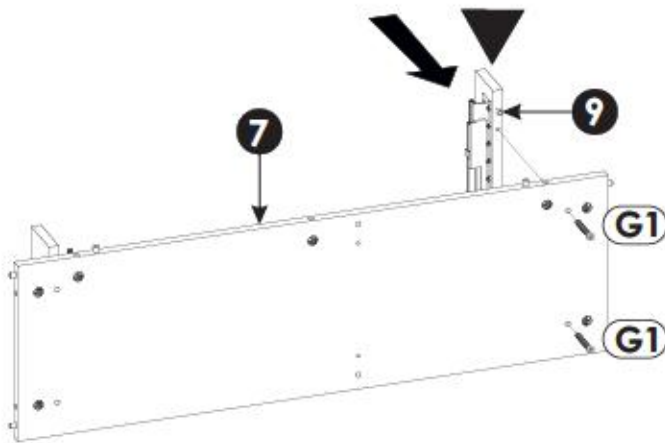
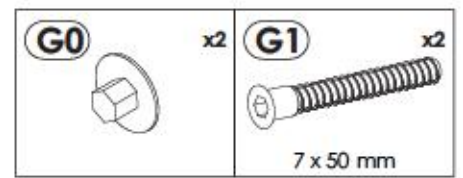
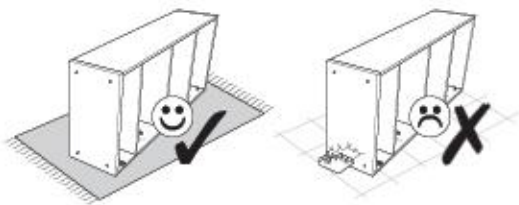

6 ▶

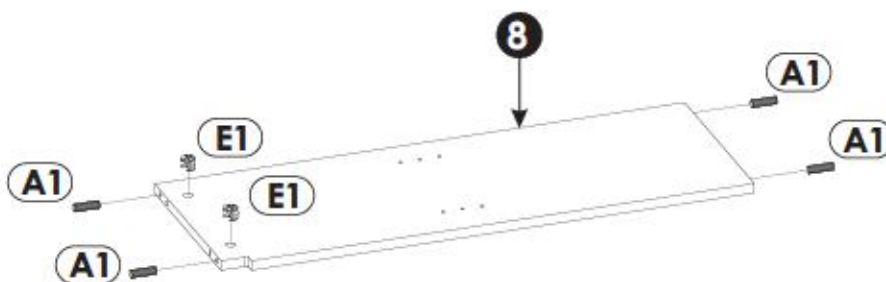

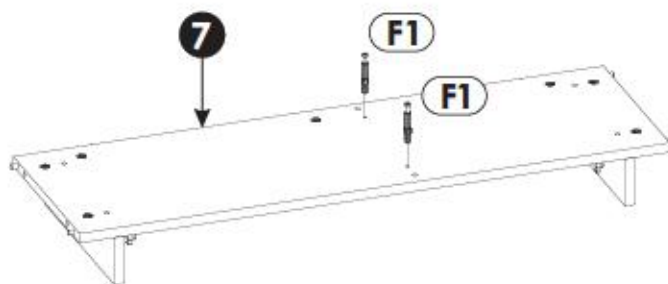
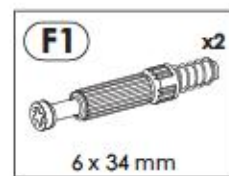
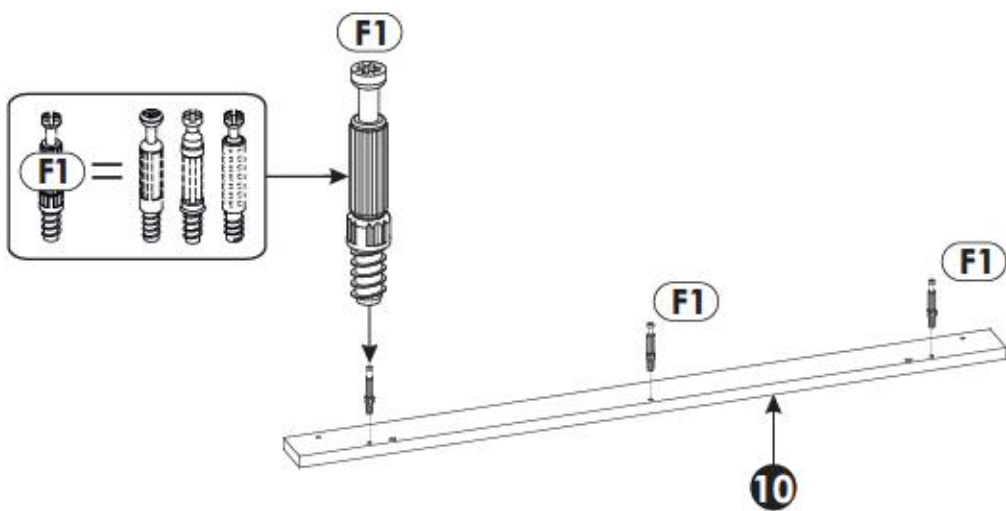
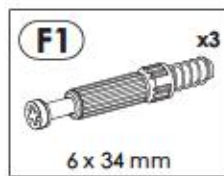

9 ▶

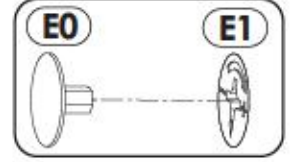
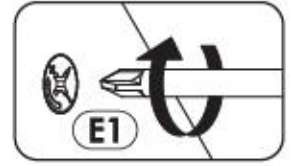
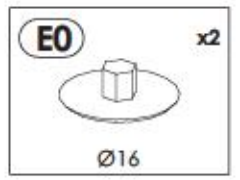
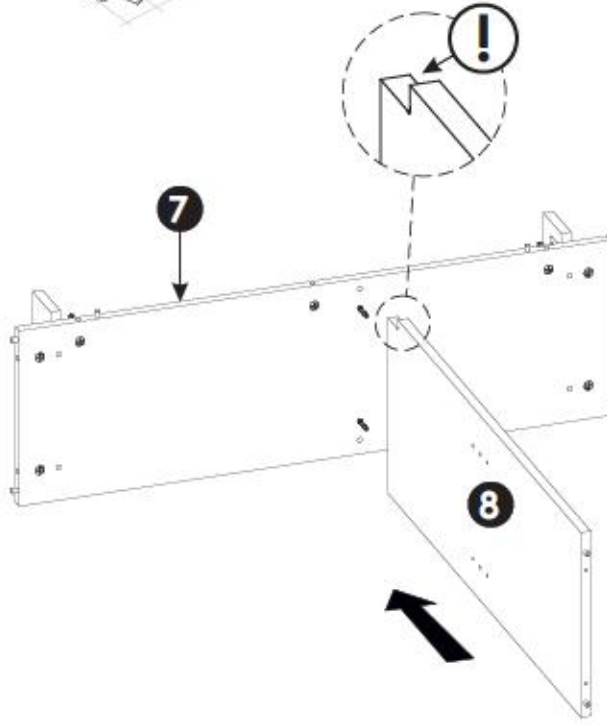
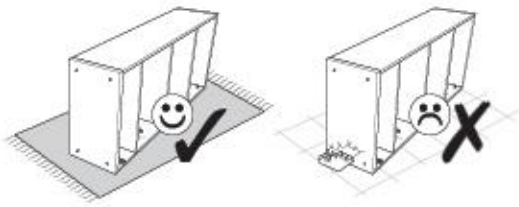

10 ▶

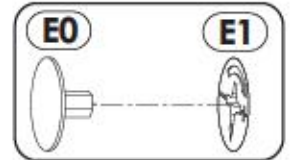
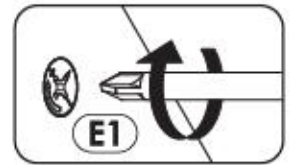
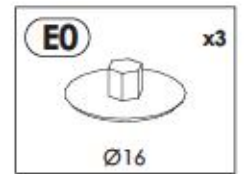
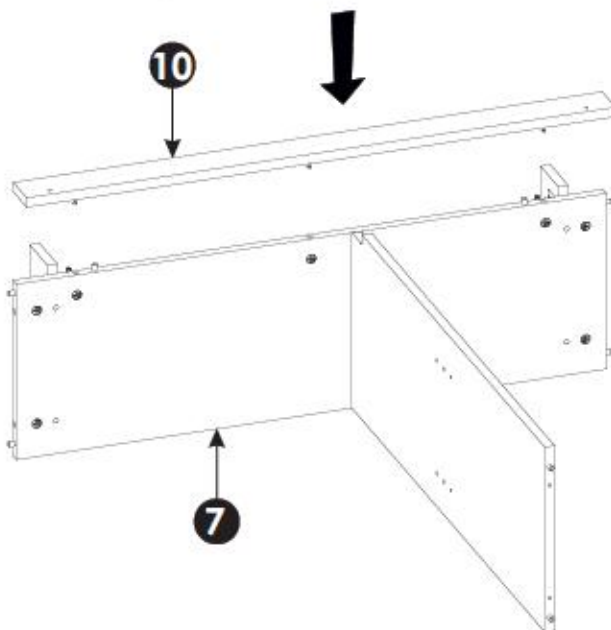
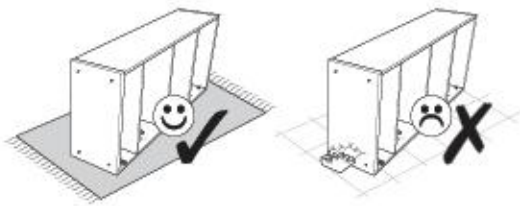

11▶

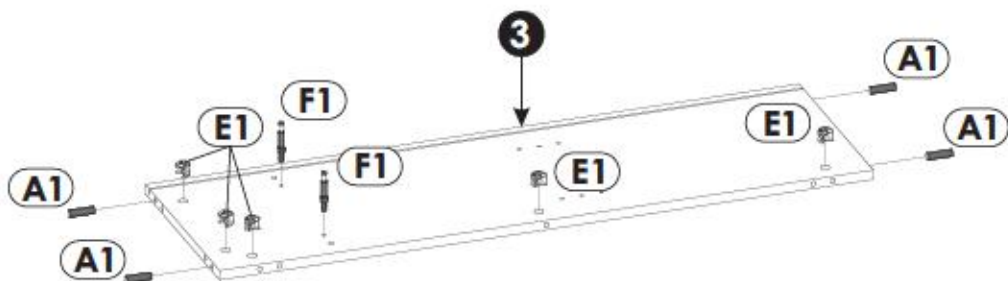
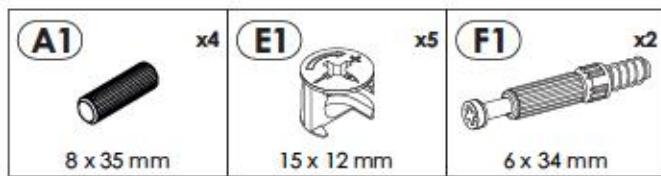

12▶

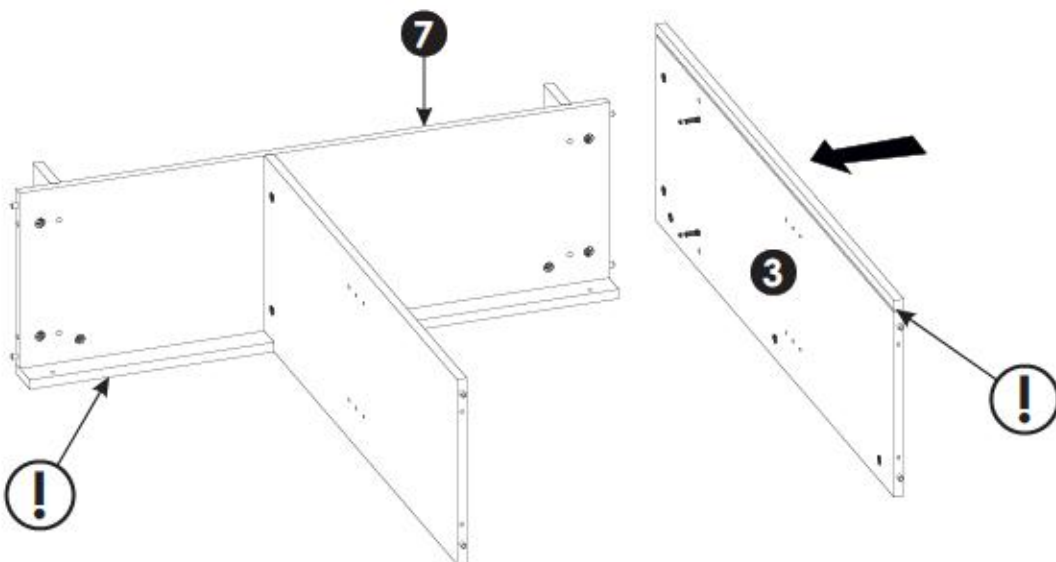
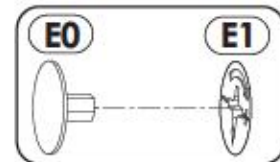
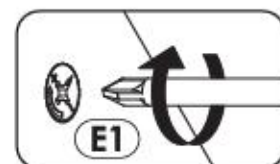
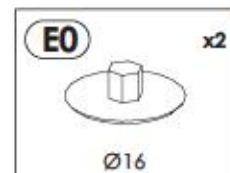
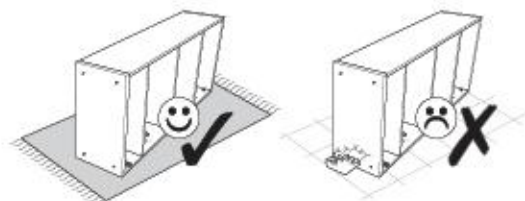

13▶

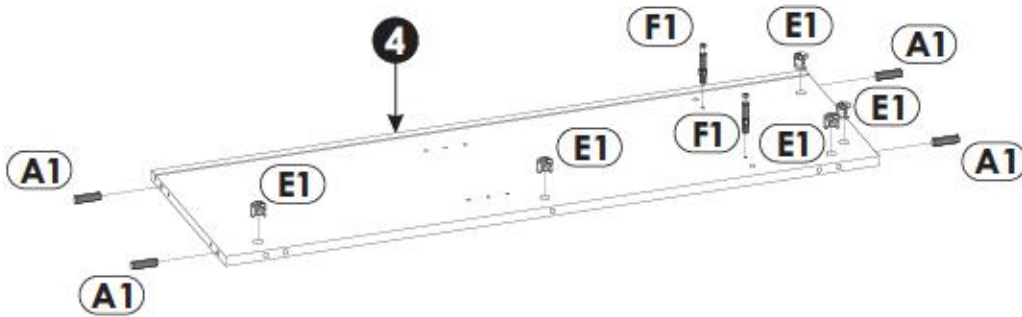
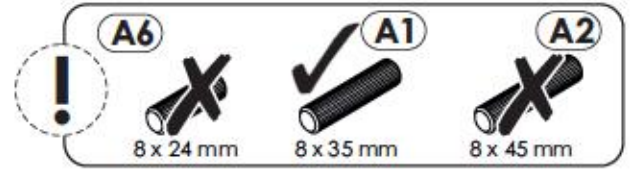
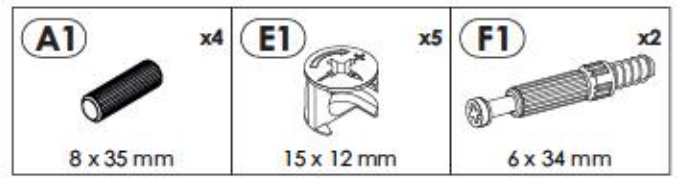

14▶

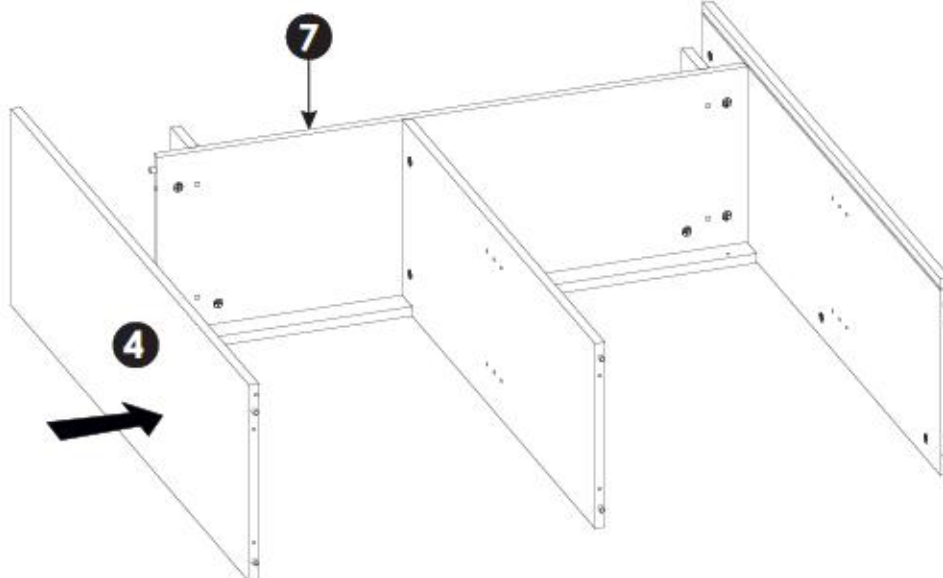
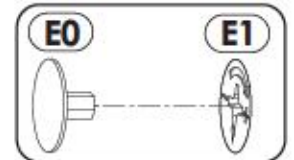
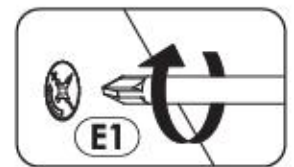
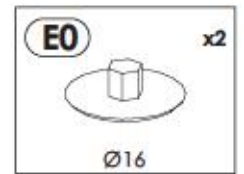
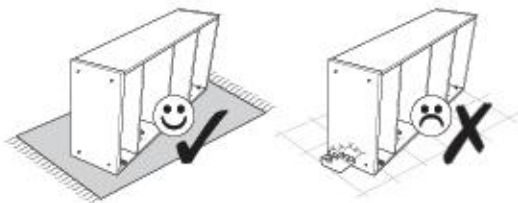

15▶

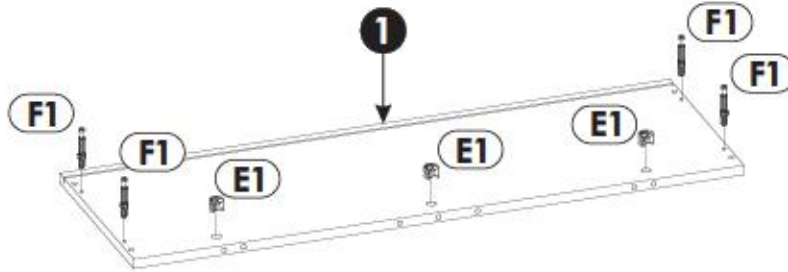
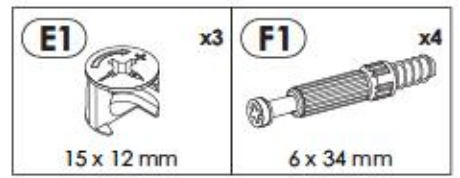

16▶

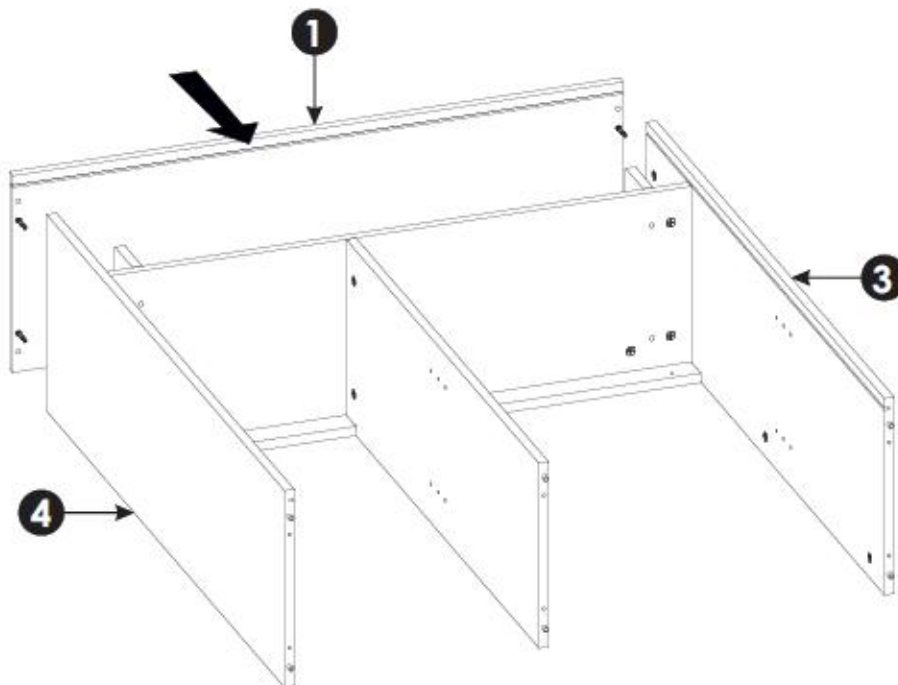
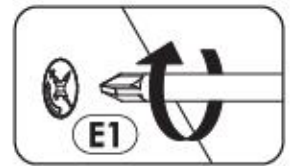
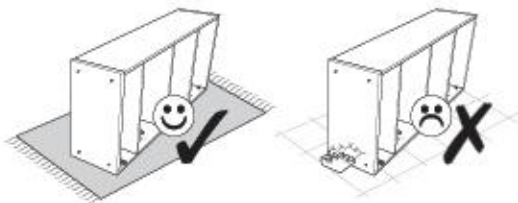

17▶

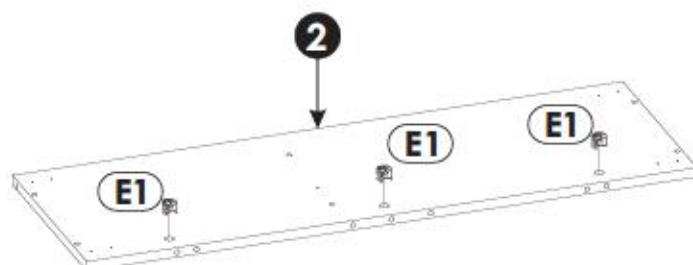
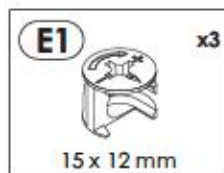

18▶

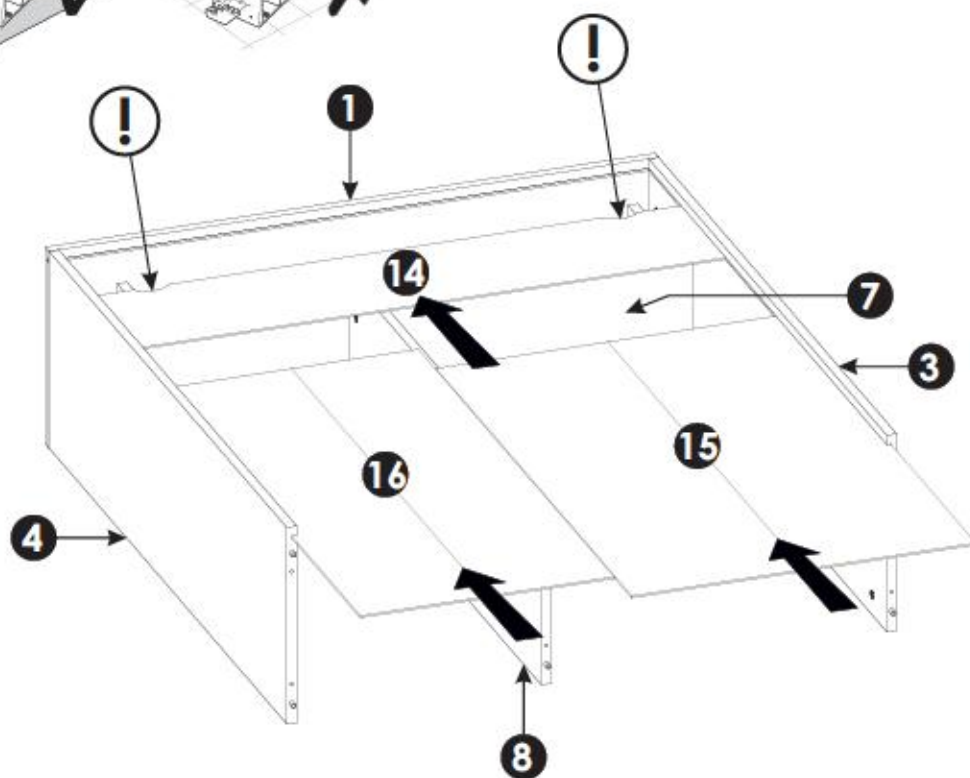
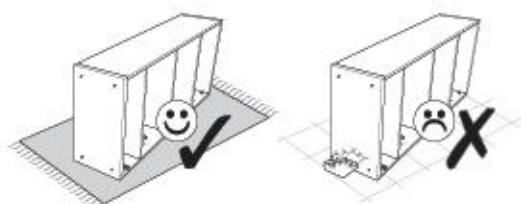

19 ▶

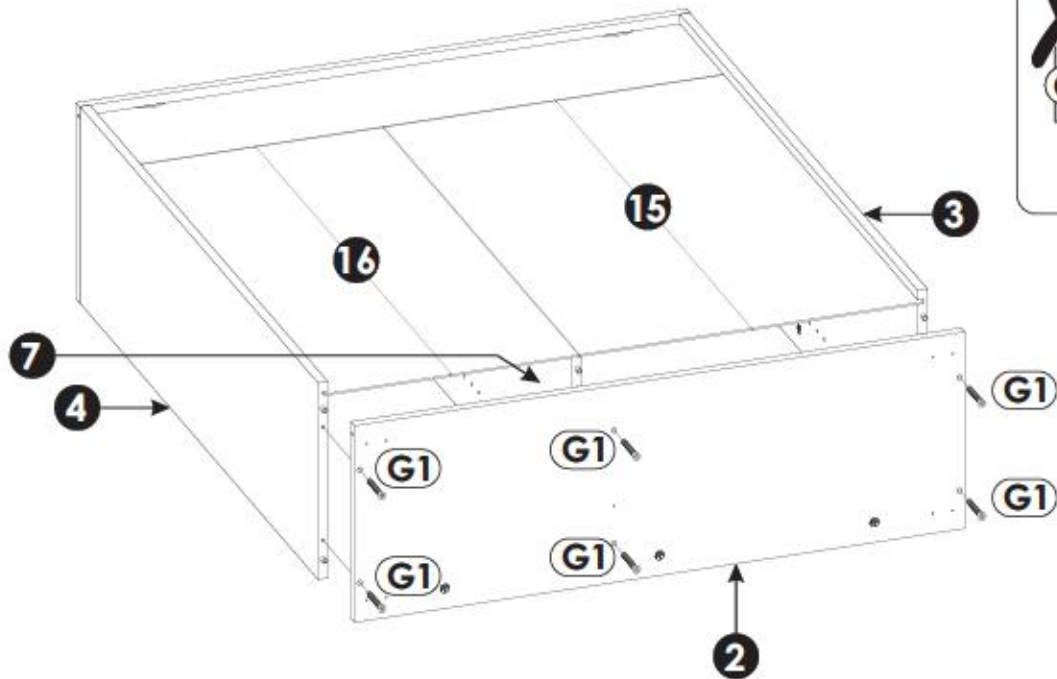
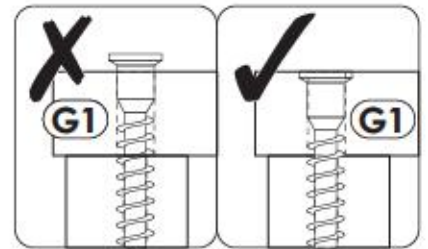
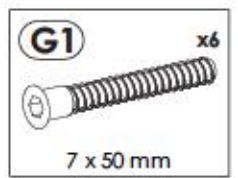
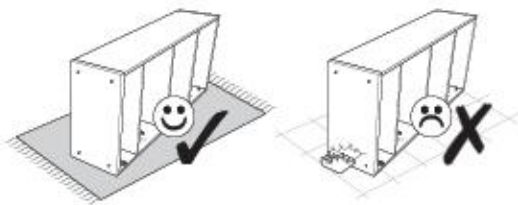

20 ▶

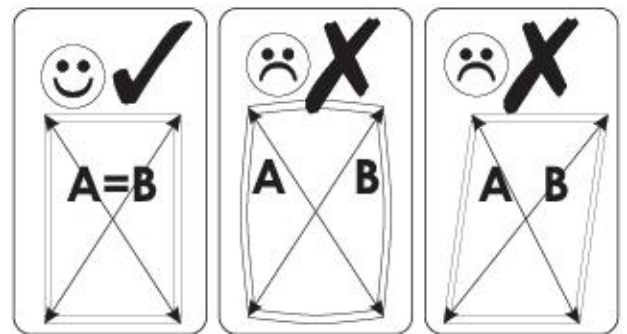
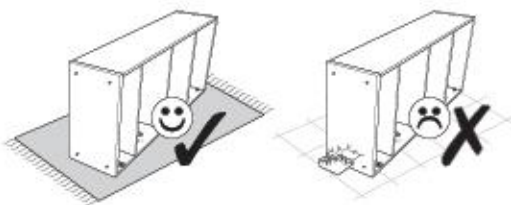

A=B

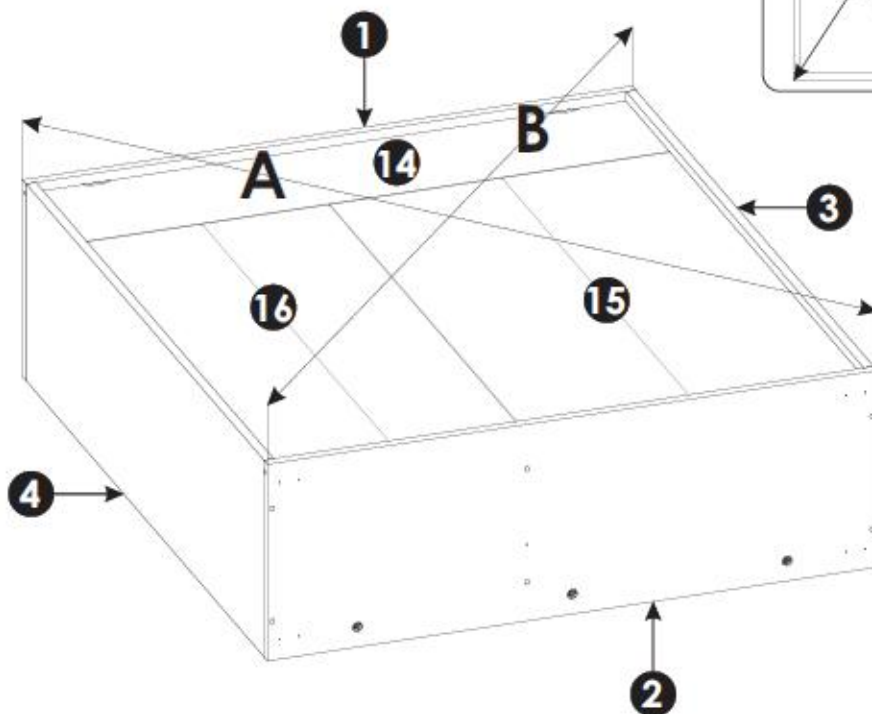

21 ▶

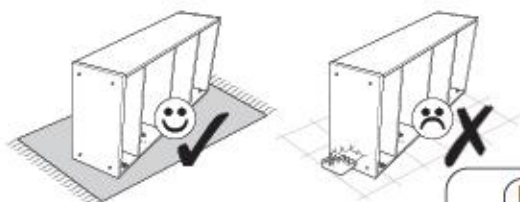

N1 x11 3 x 16 mm	R1 x11	R4 x10
-------------------------------	------------------	------------------

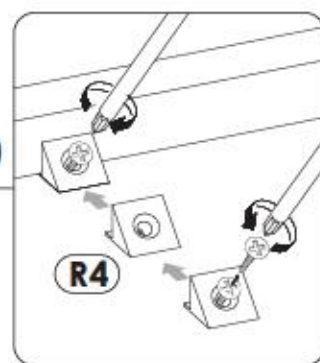
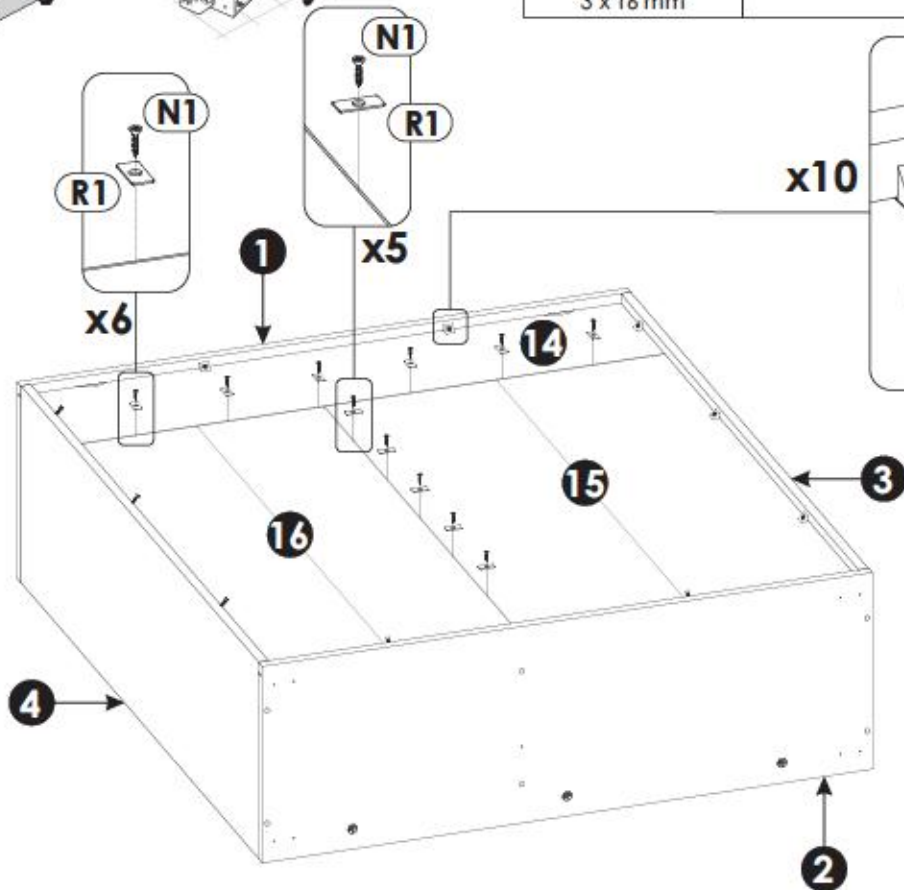

22 ▶

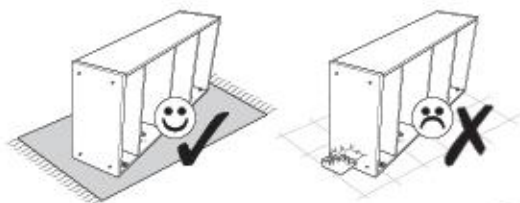

I3 x8 3,5 x 22 mm	I4 x1 3,5 x 27 mm
O1 x1	O3 x4

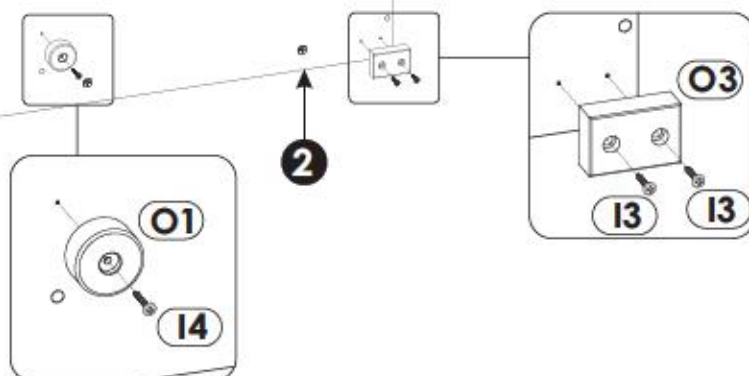
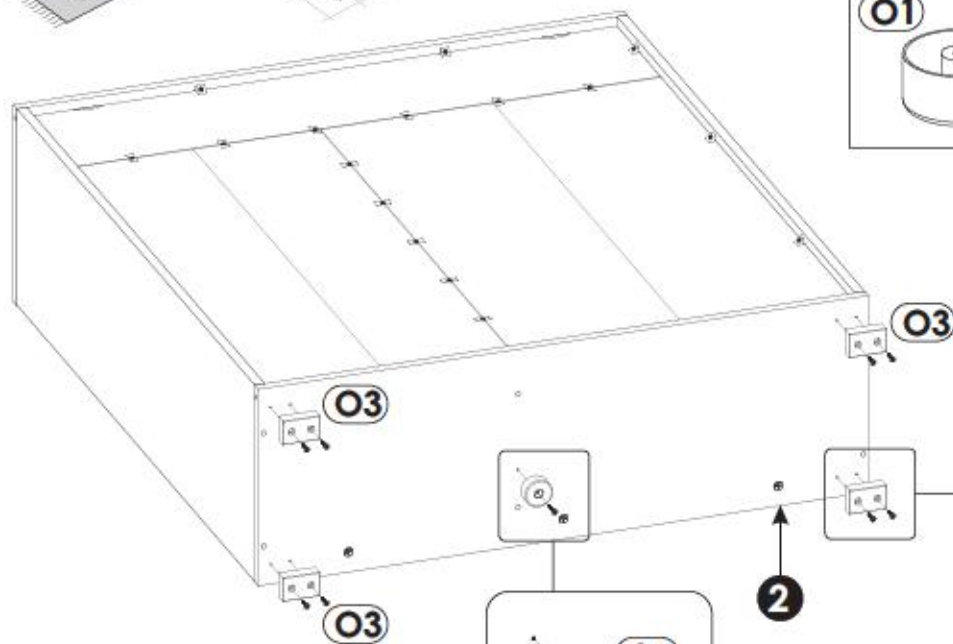

23▶

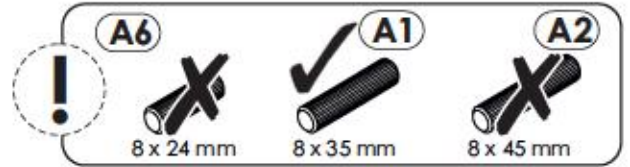
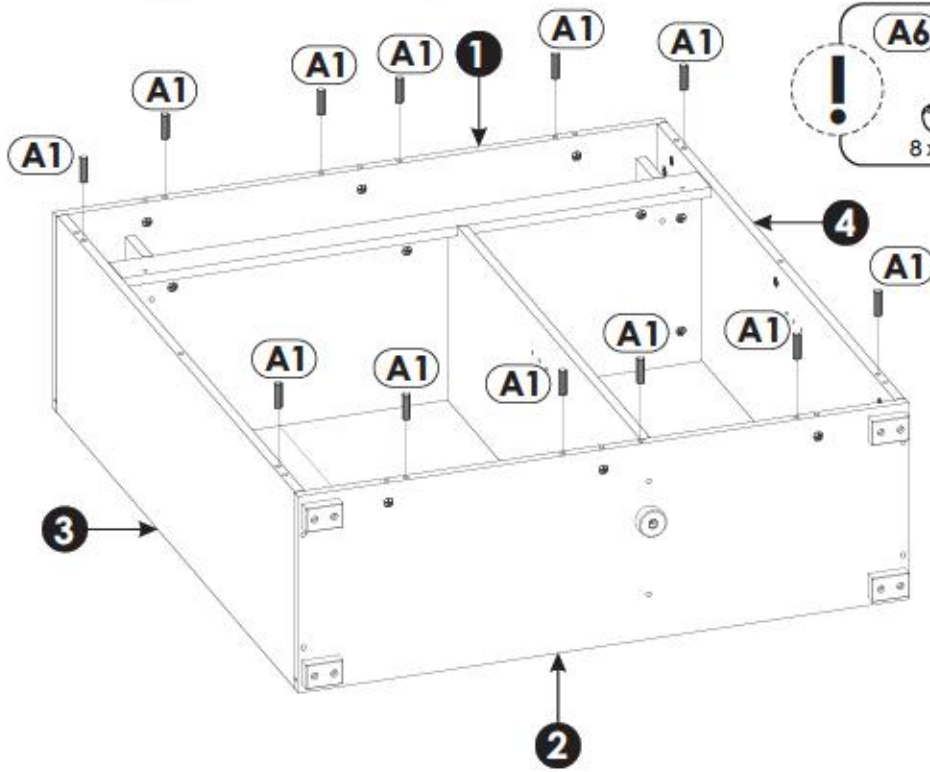
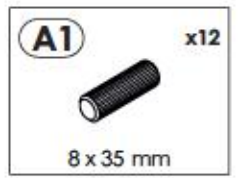
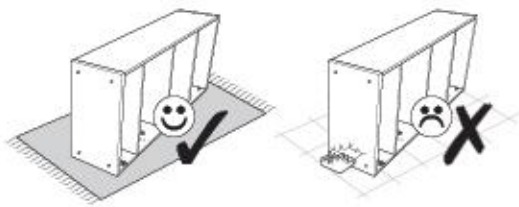

24▶

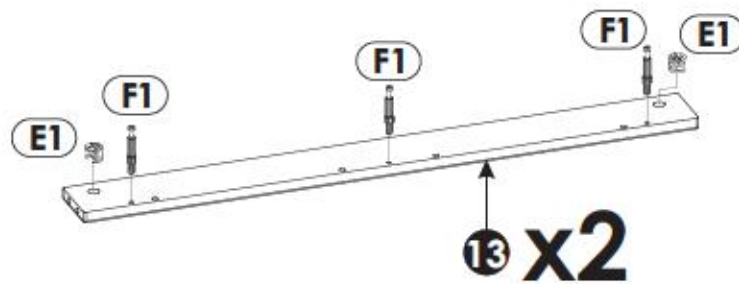
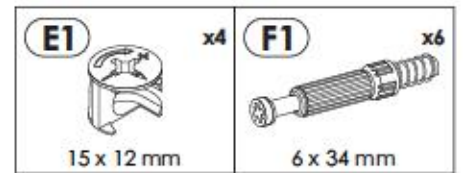

25▶▶

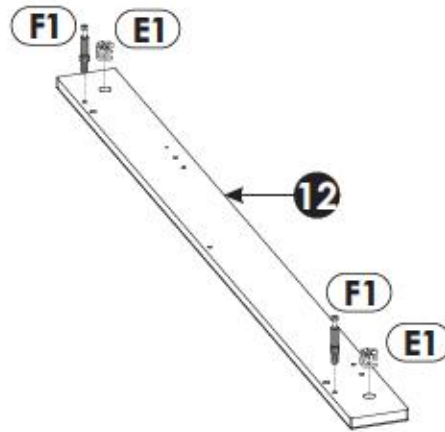
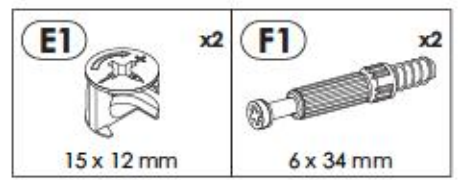

26▶▶

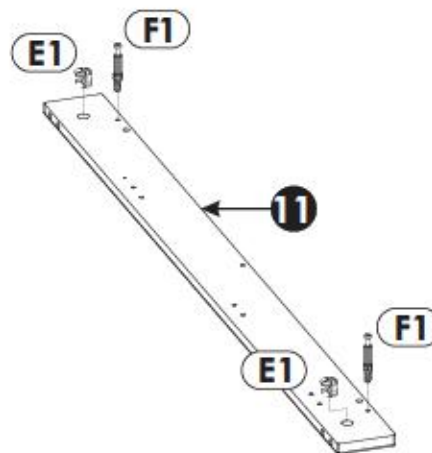
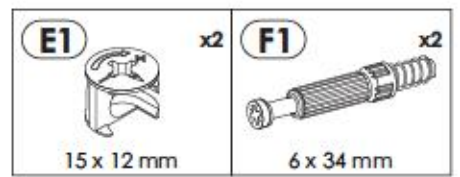

27▶

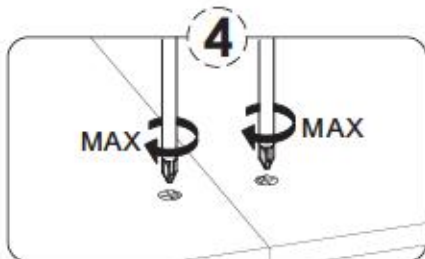
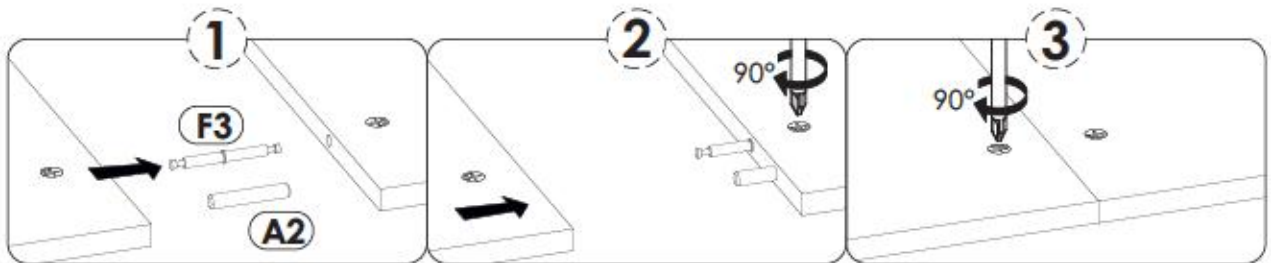
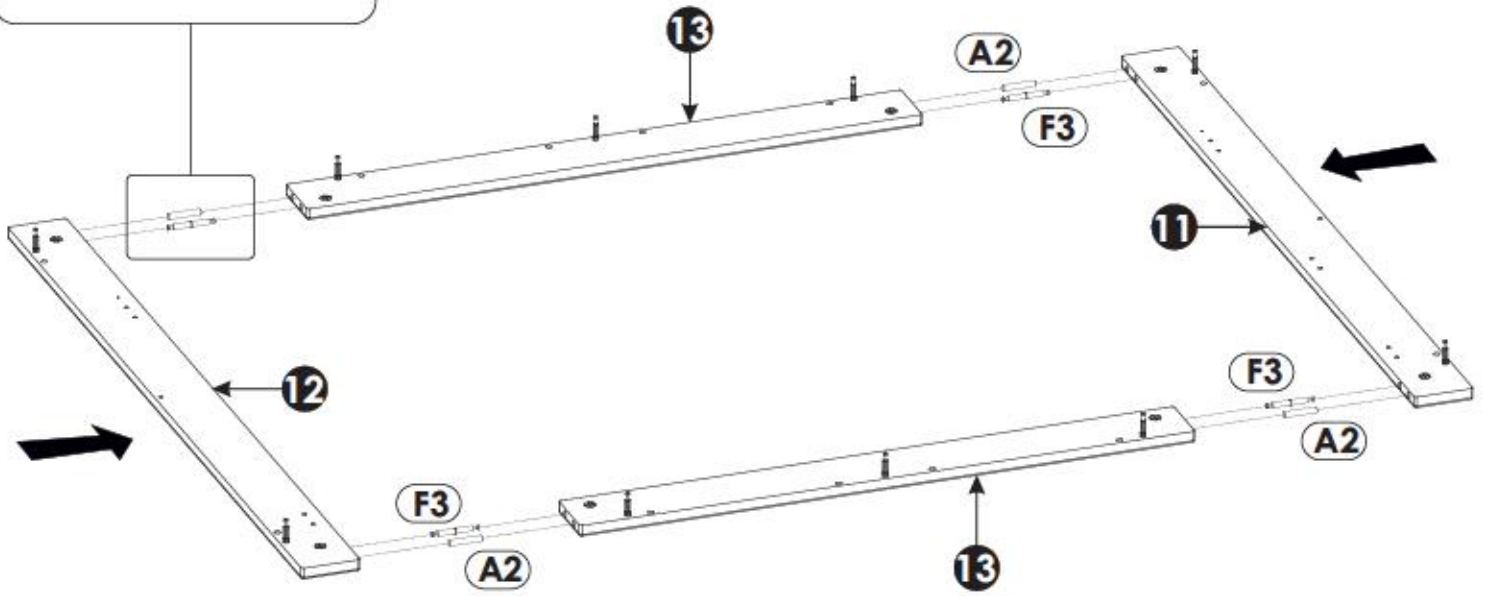
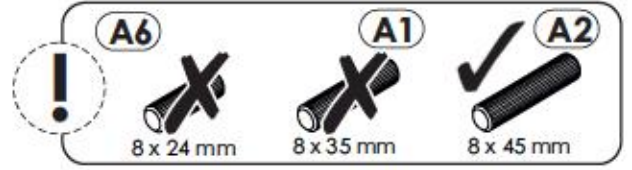
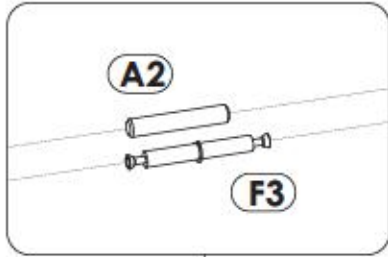
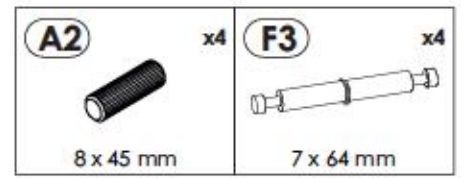
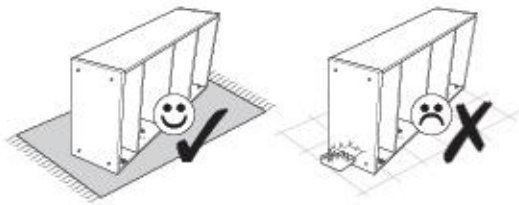

28 ▶

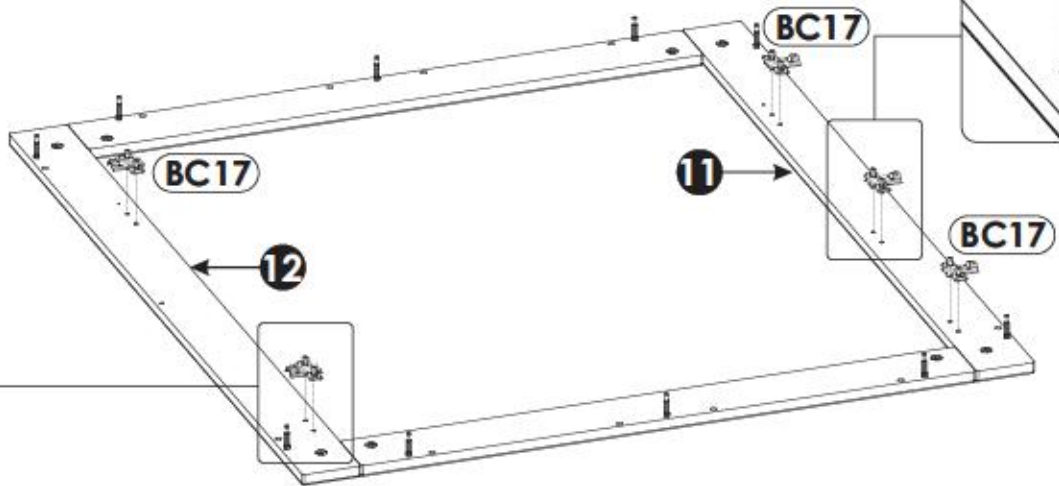
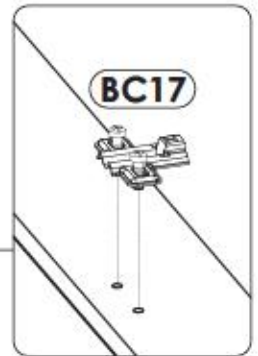
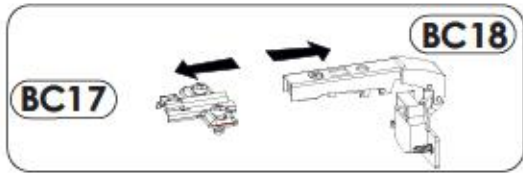
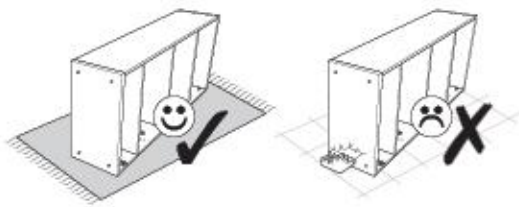

29 ▶

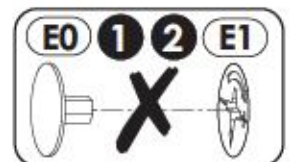
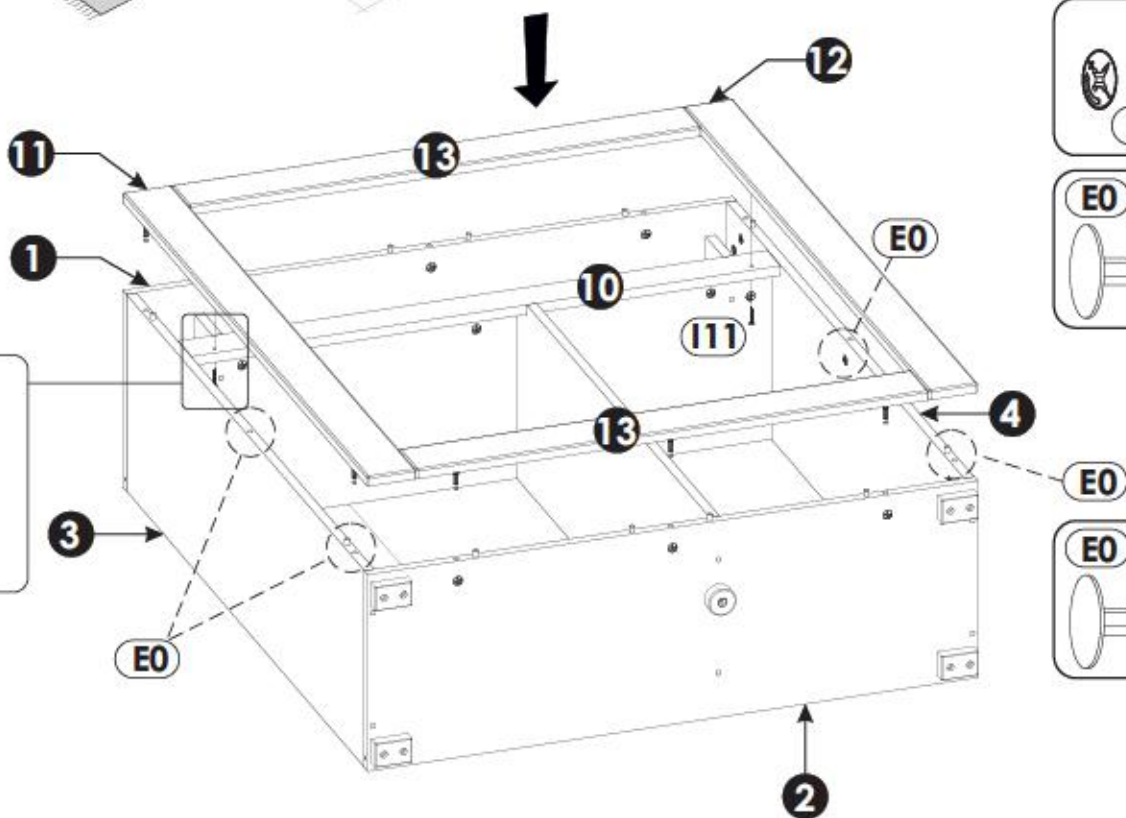
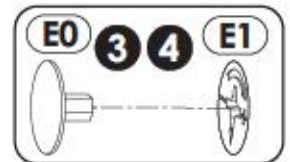
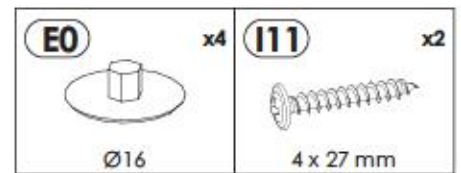
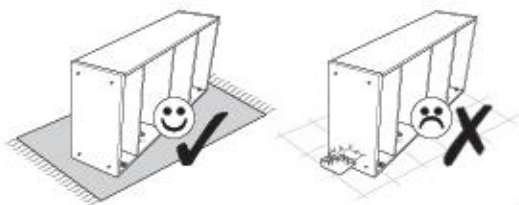

30 ▶

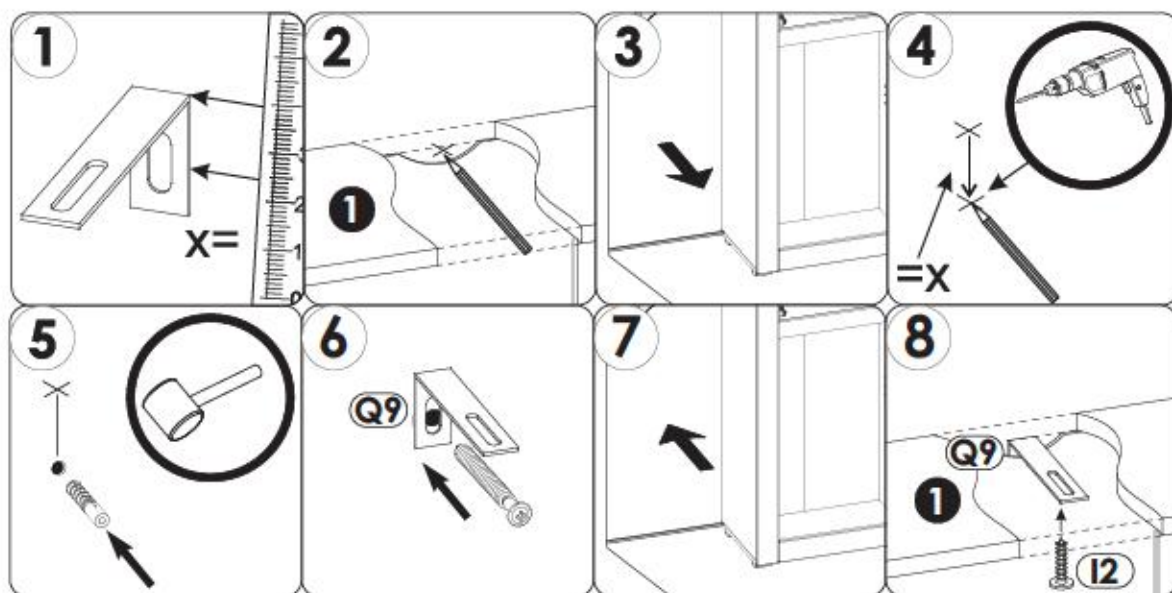
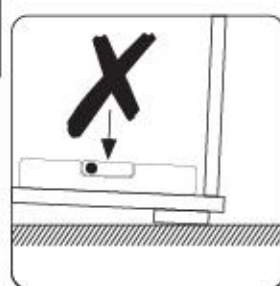
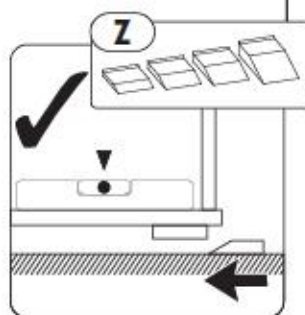
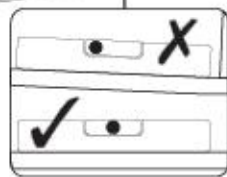
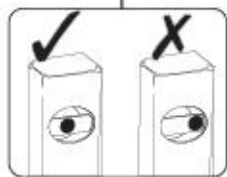
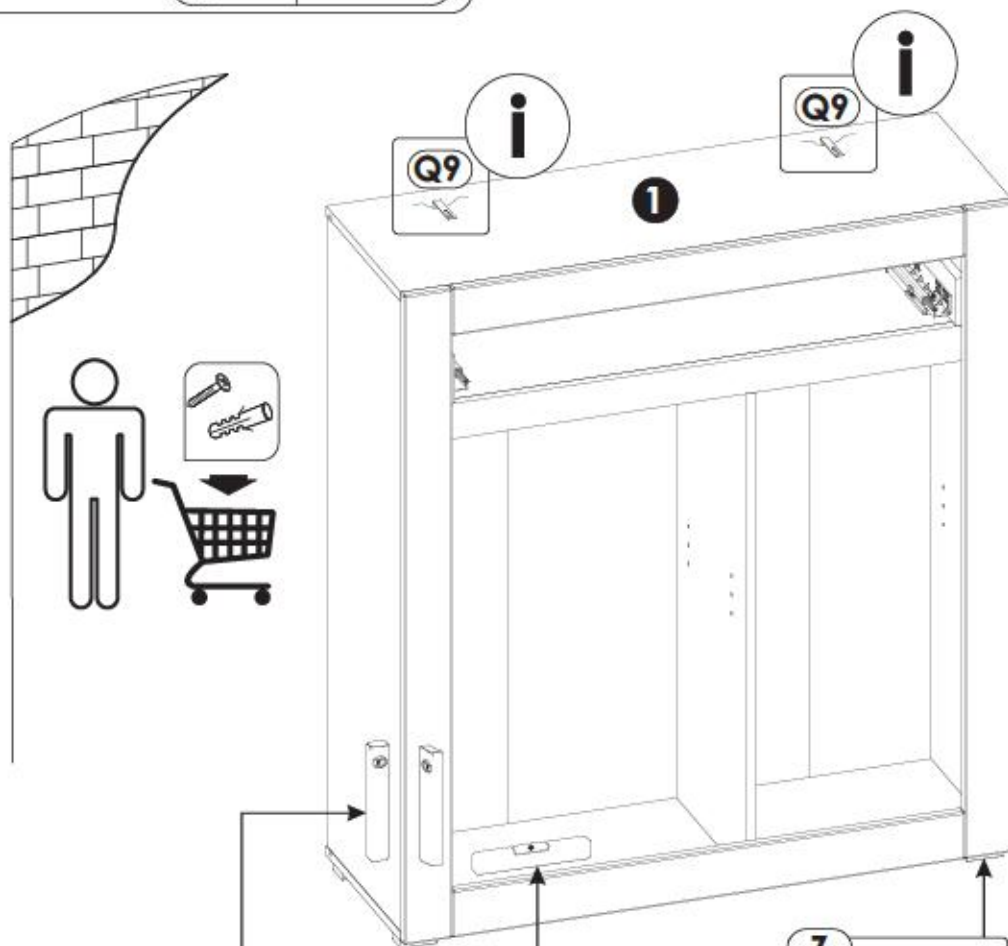
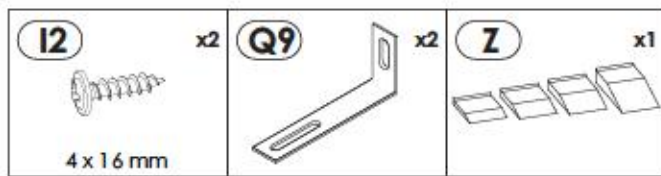
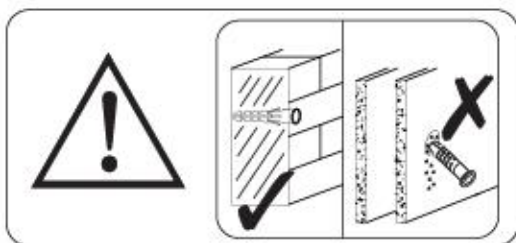

31▶

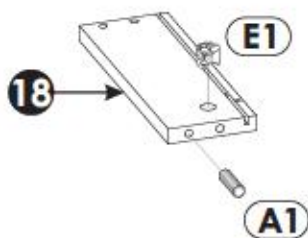

32▶

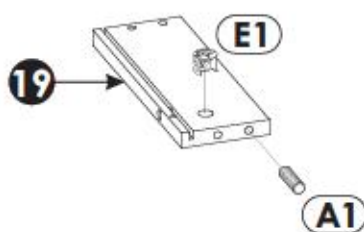
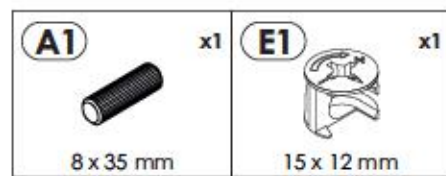

33▶

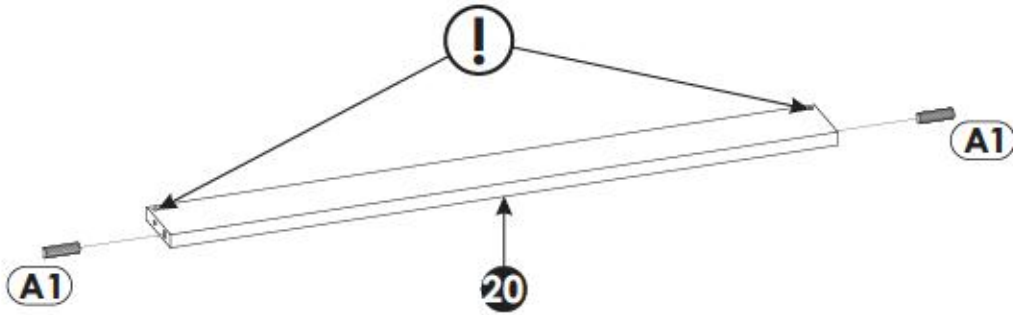
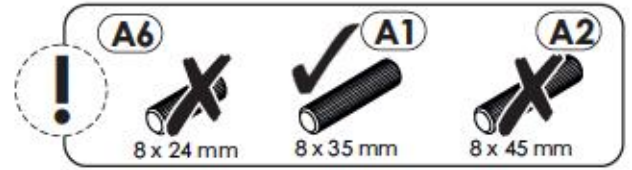
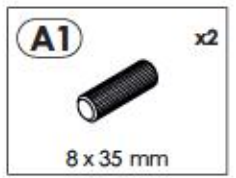
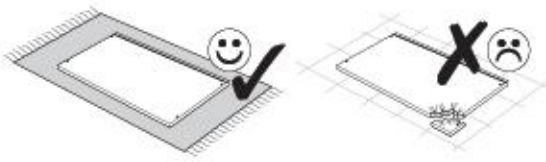

34▶

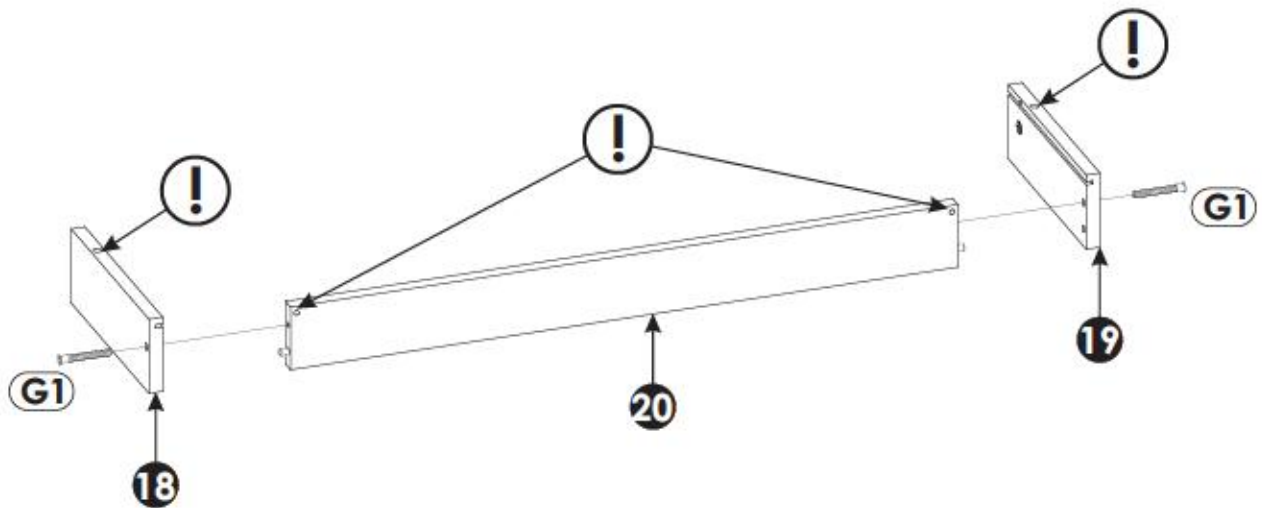
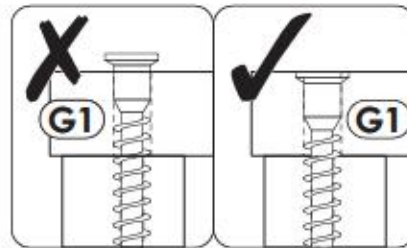
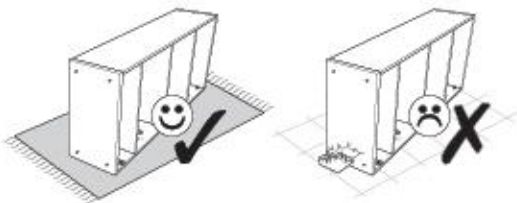

35▶

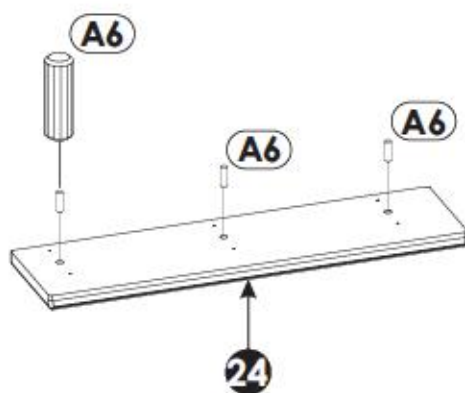
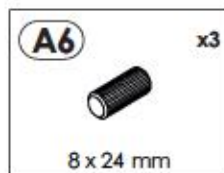

36▶

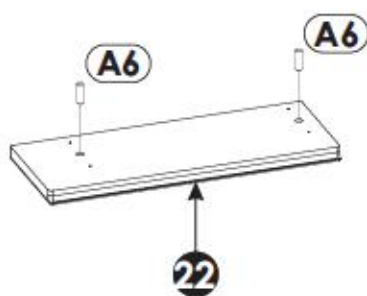

37▶

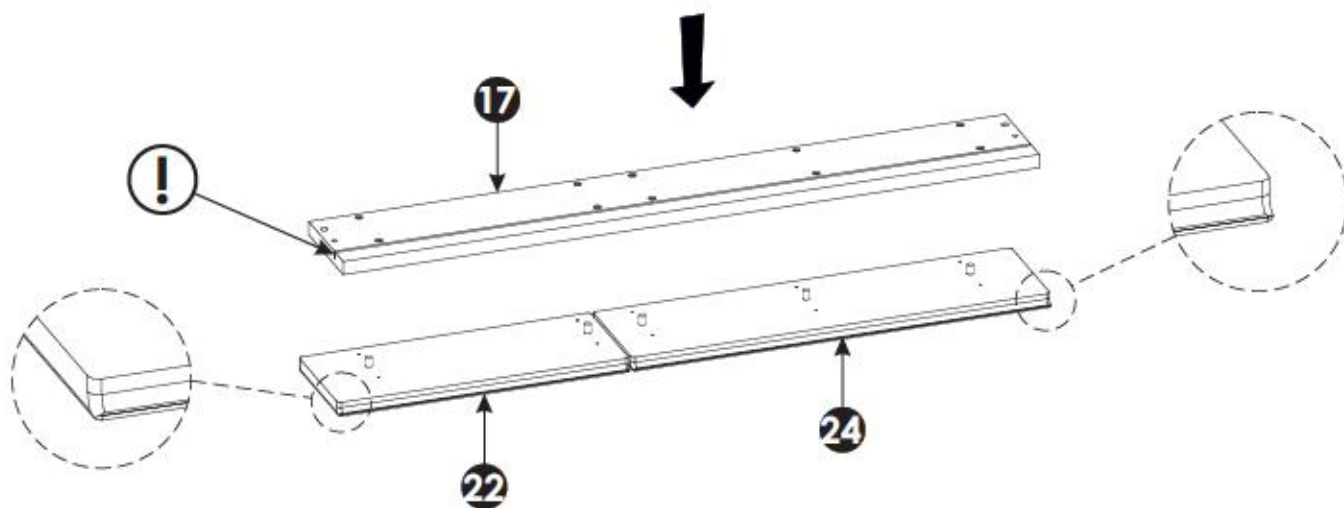
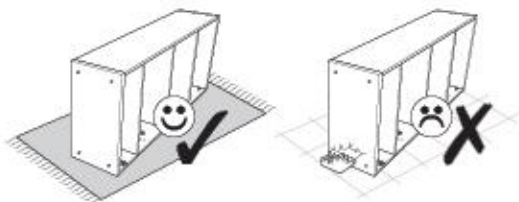

38▶

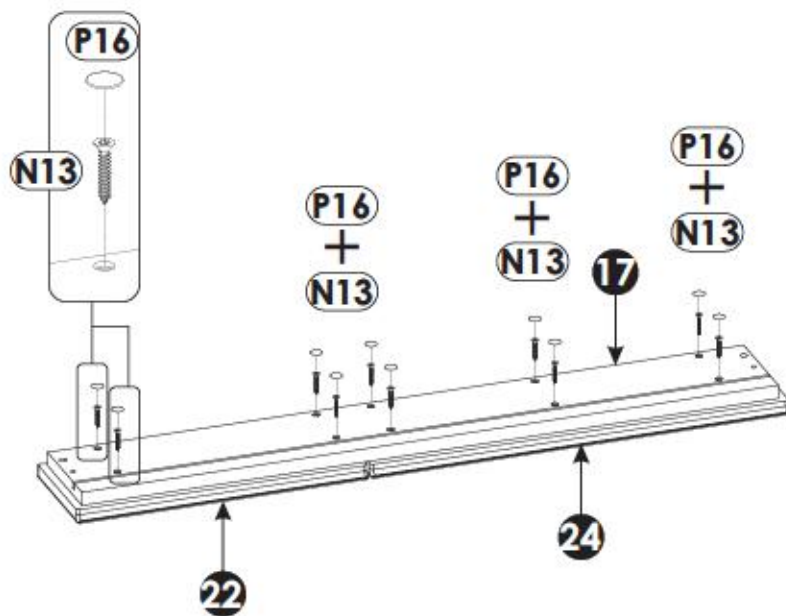
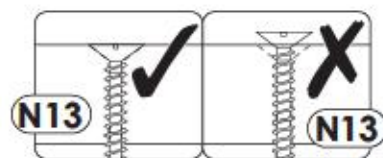
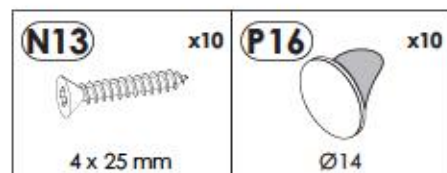
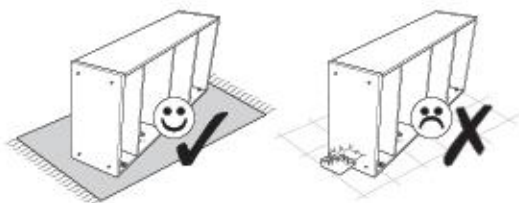

39 ▶

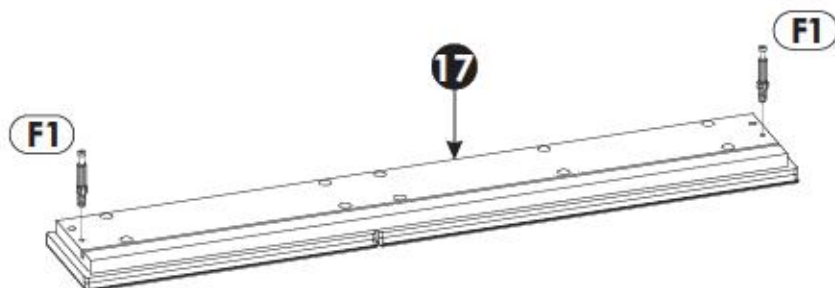
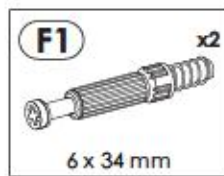
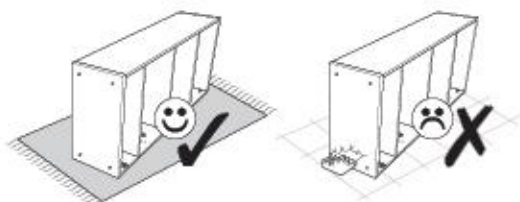

40 ▶

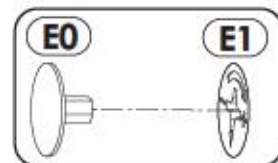
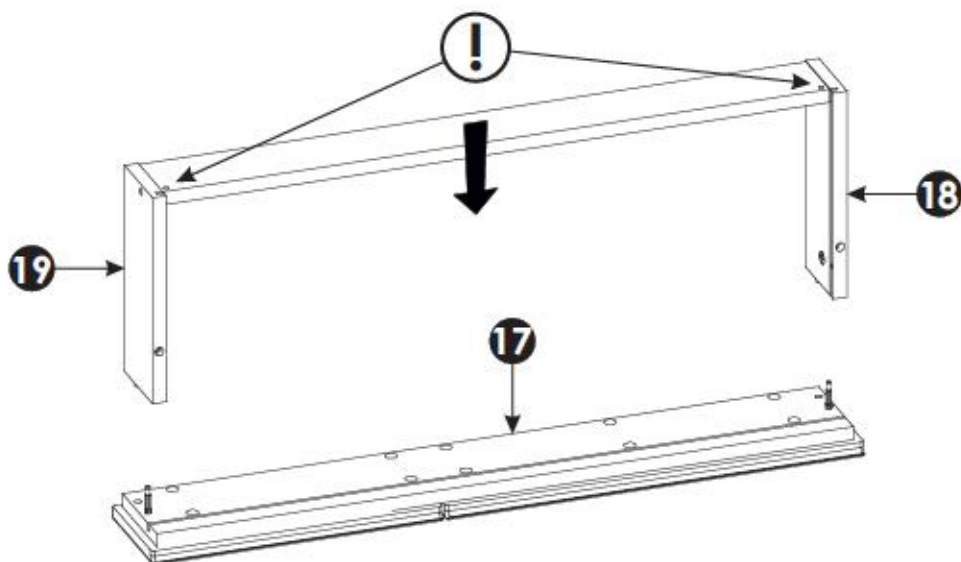
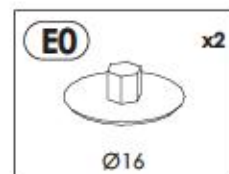
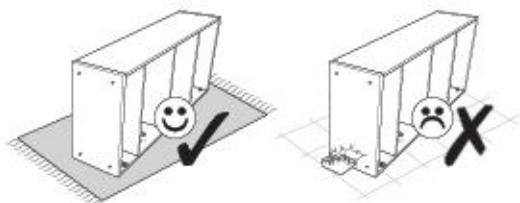

41 ▶

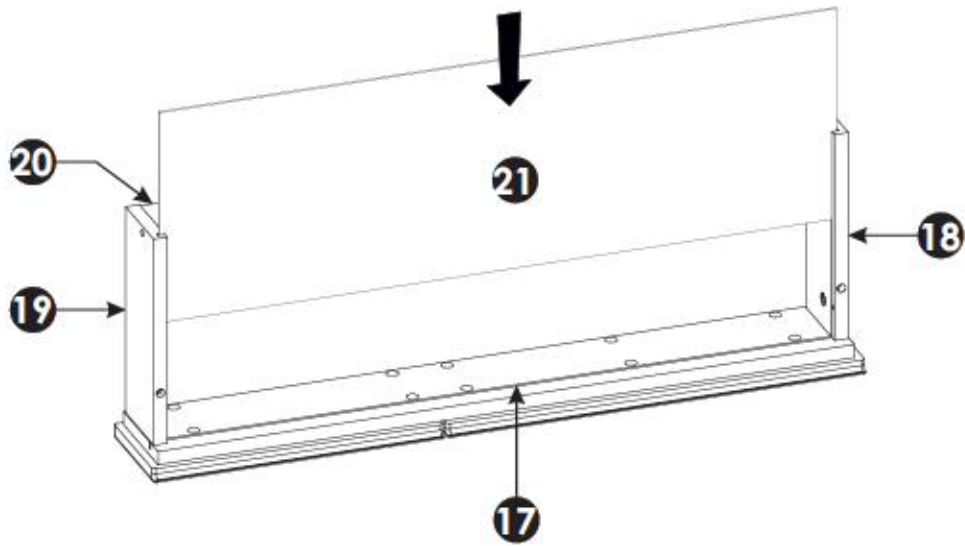
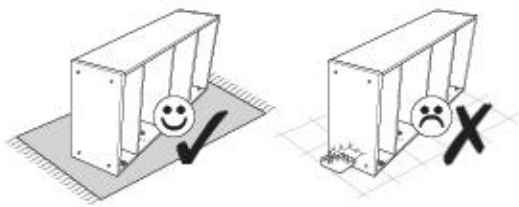

42 ▶

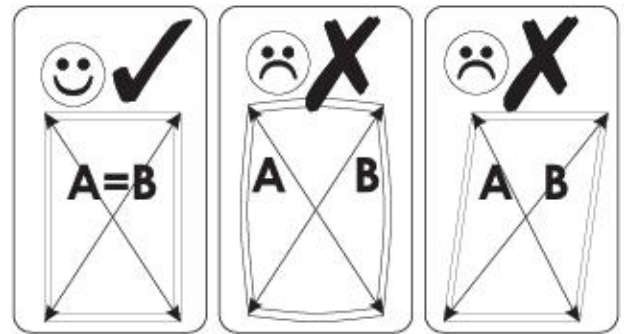
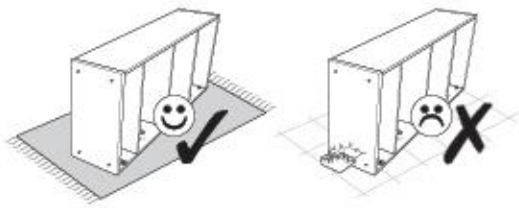

A=B

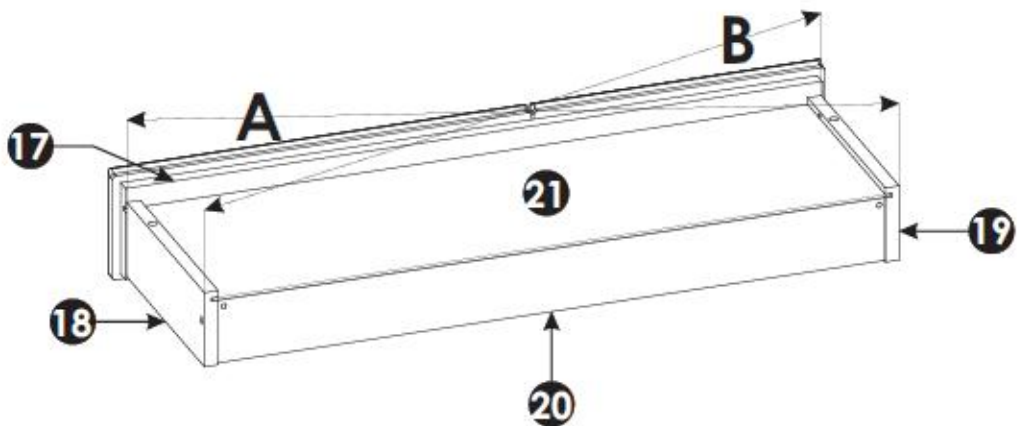

43▶

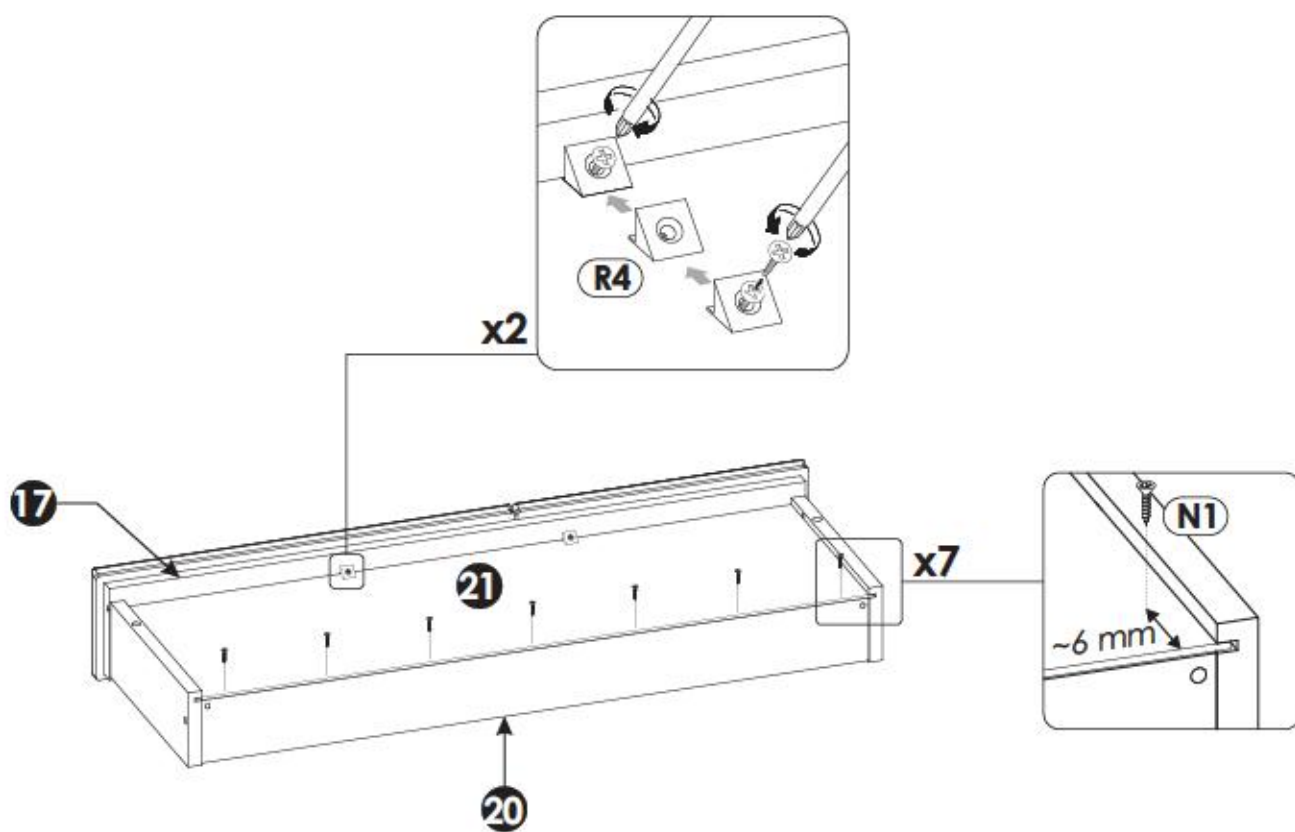
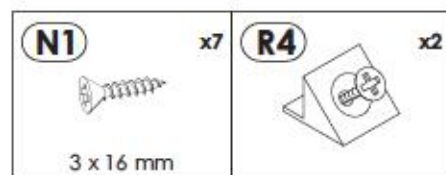
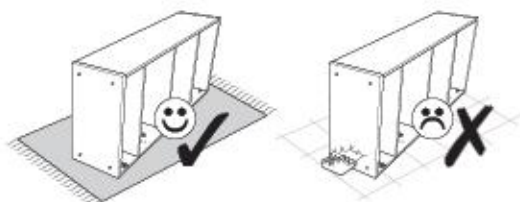

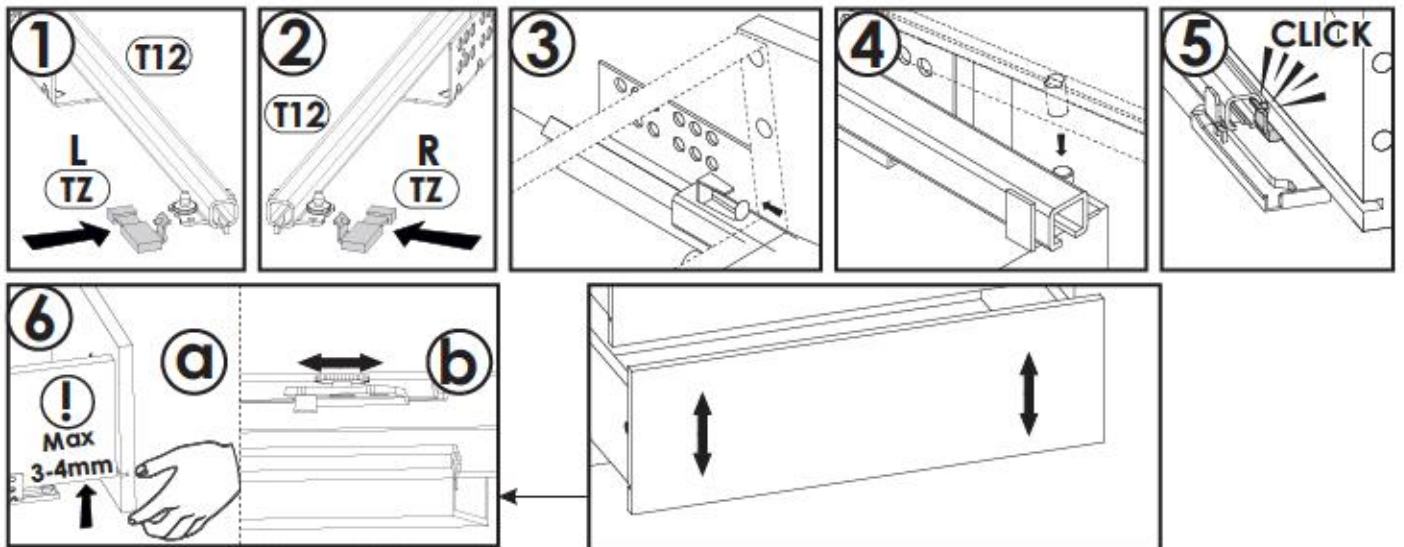
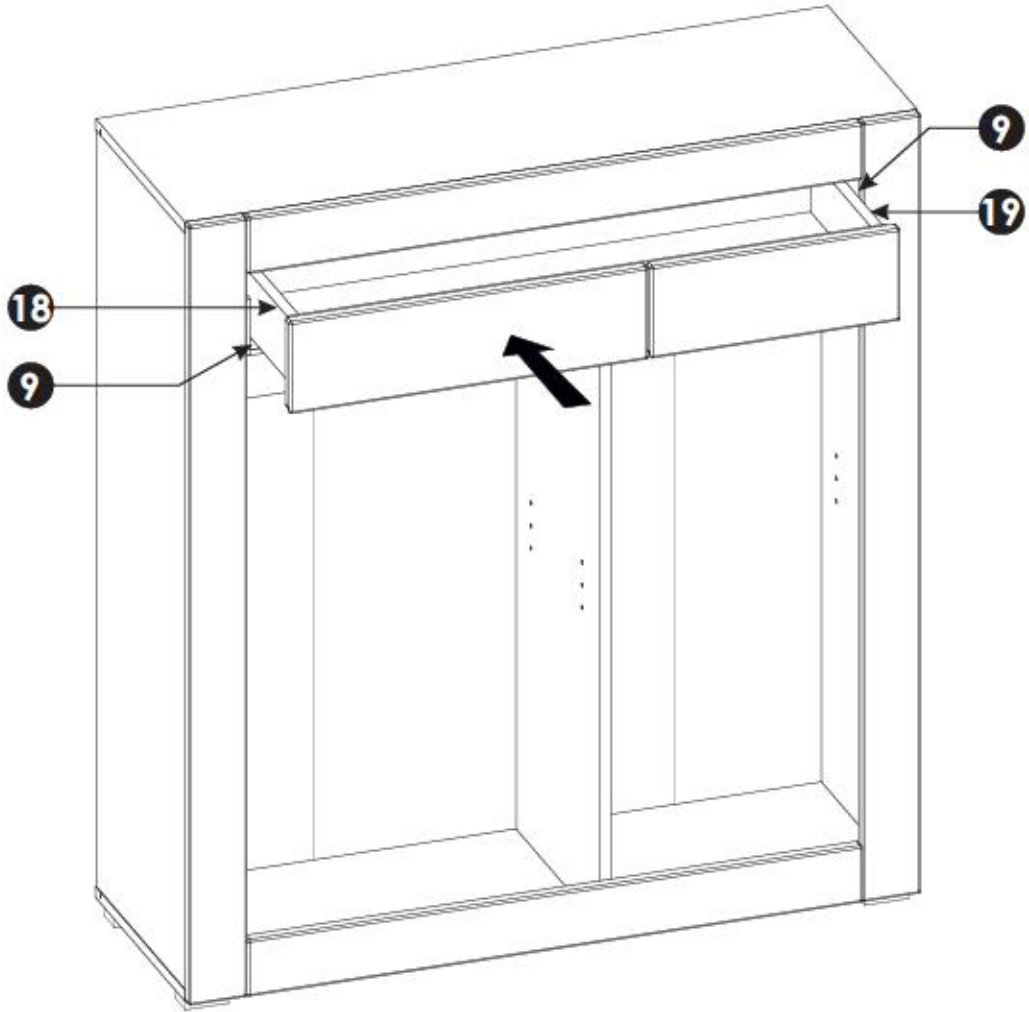
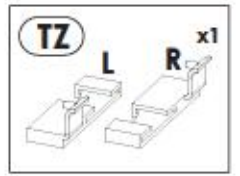

45▶

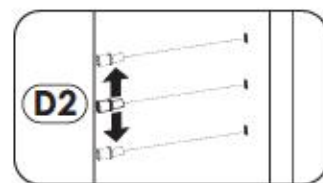
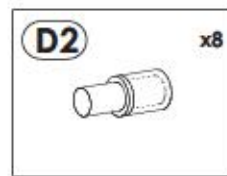
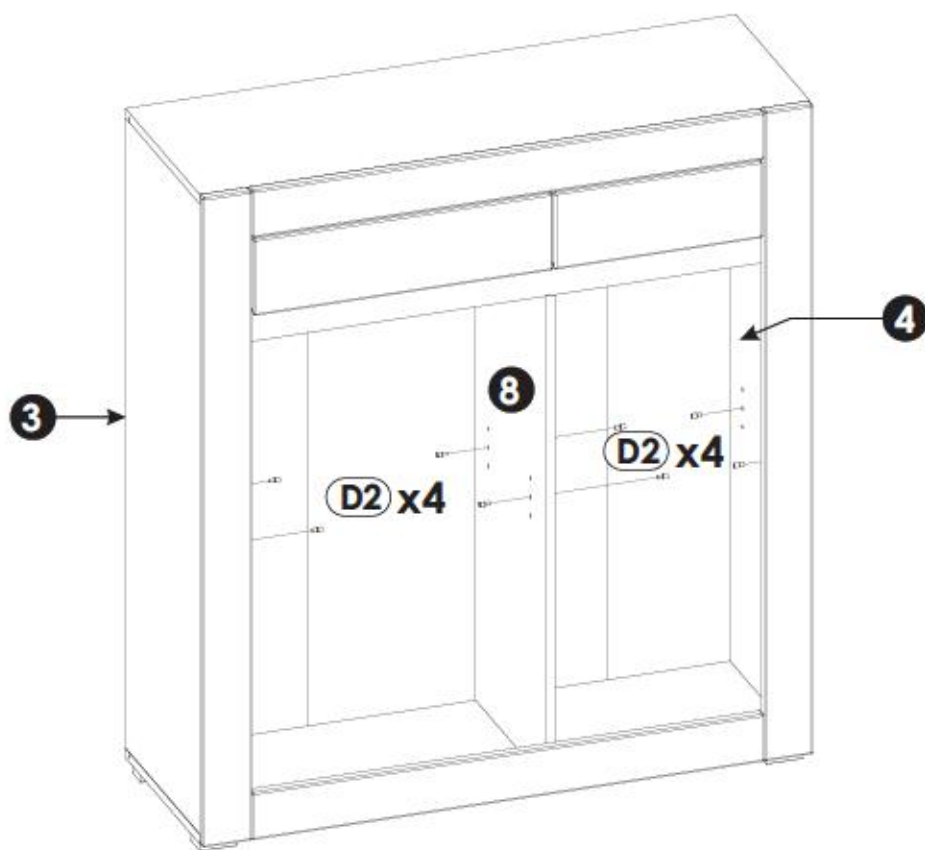

46▶

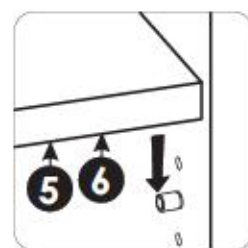
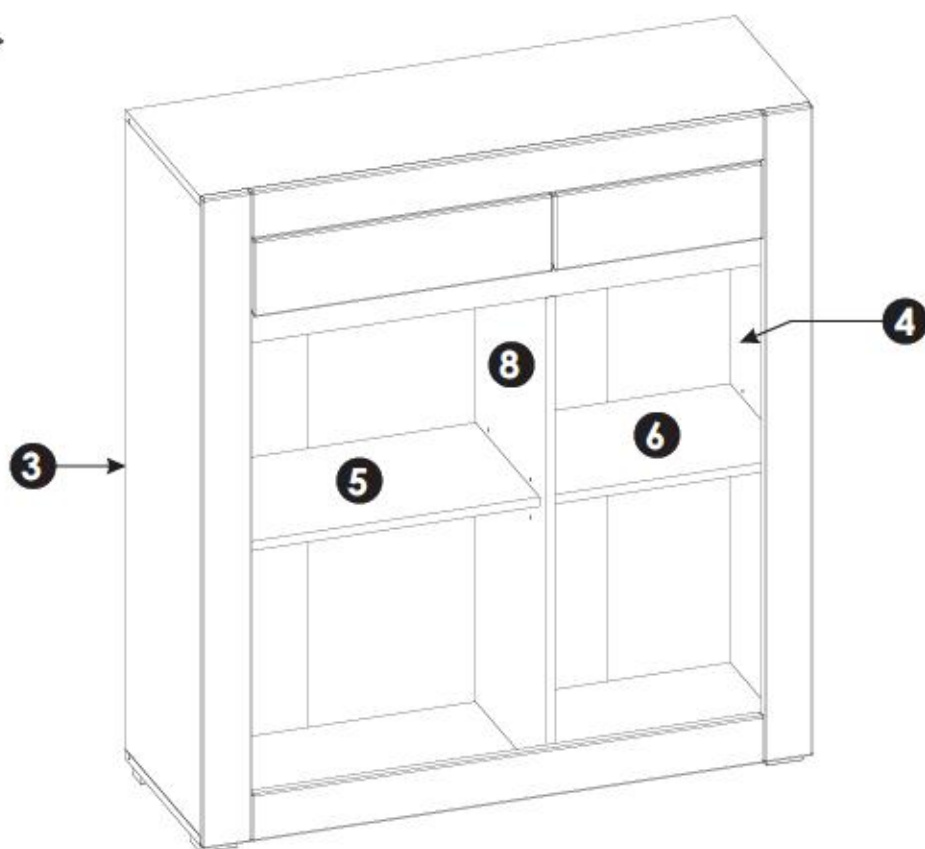

47▶

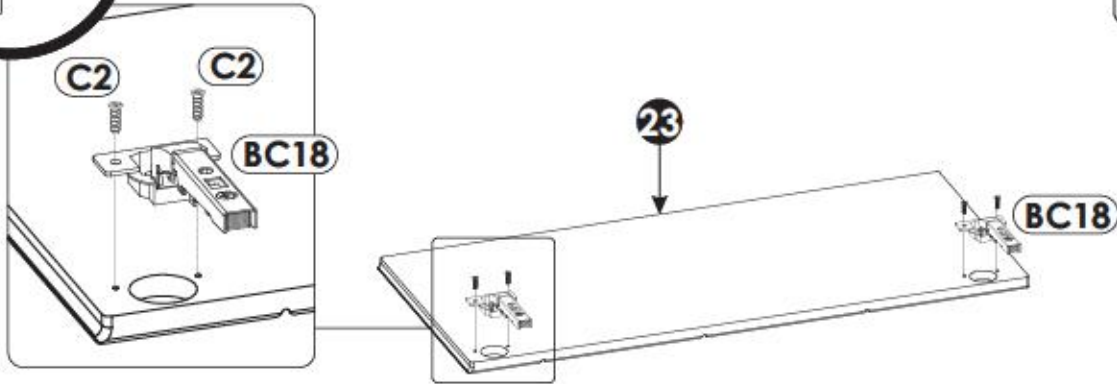
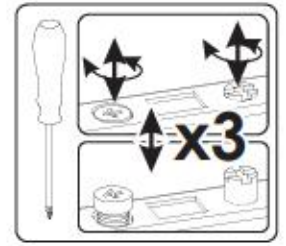
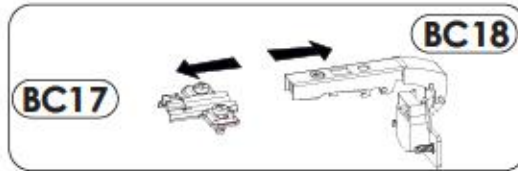
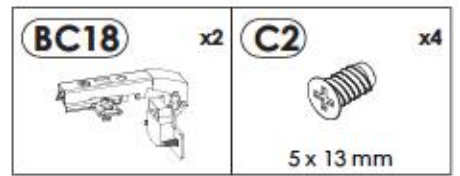
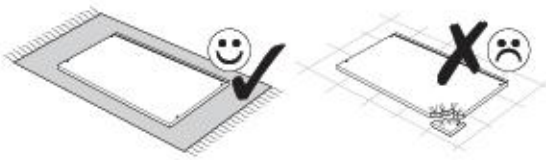

48▶

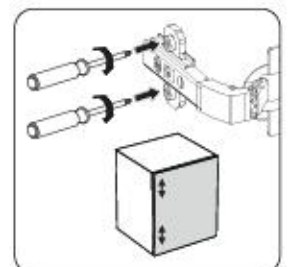
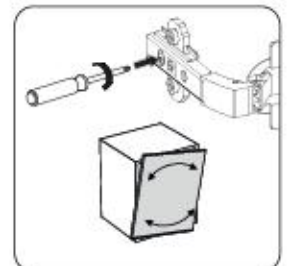
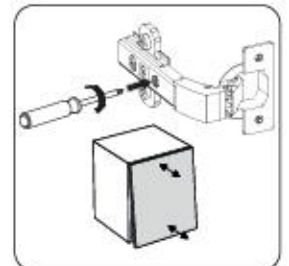
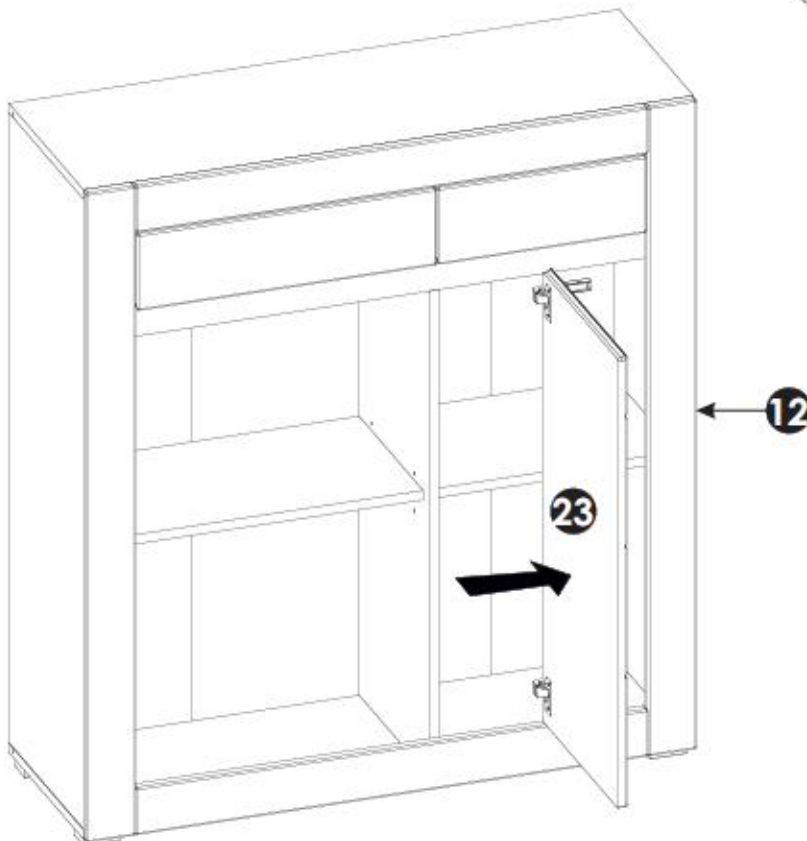
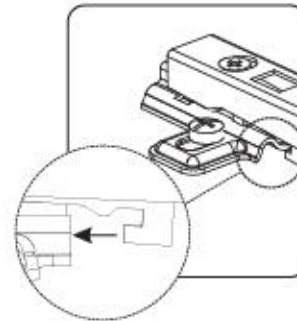

49▶

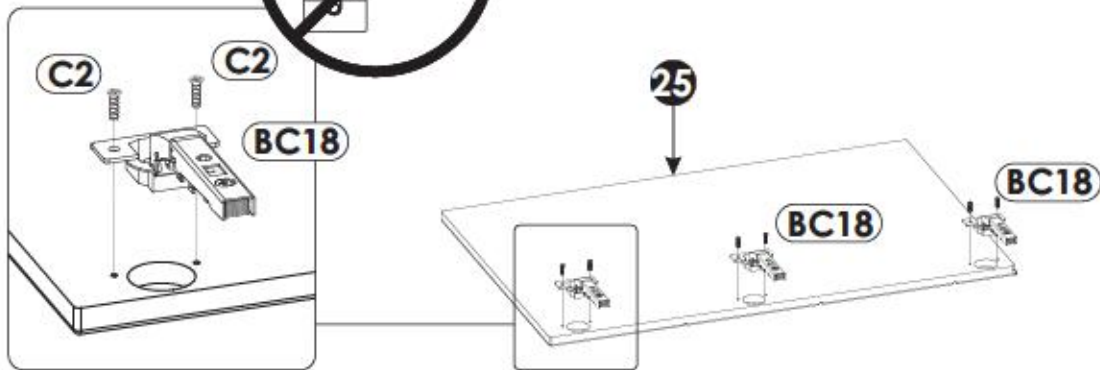
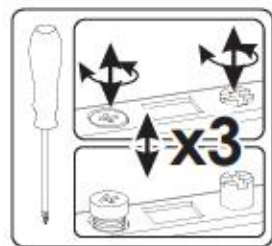
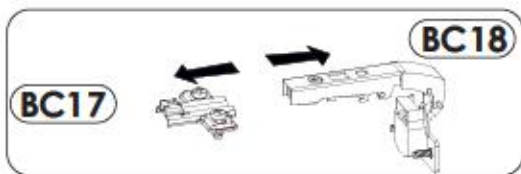
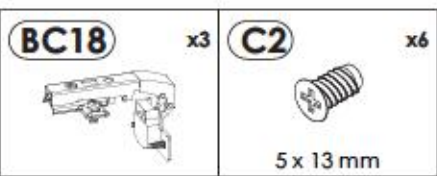
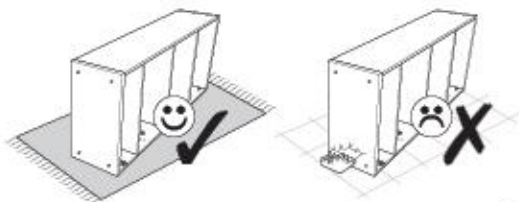

50▶

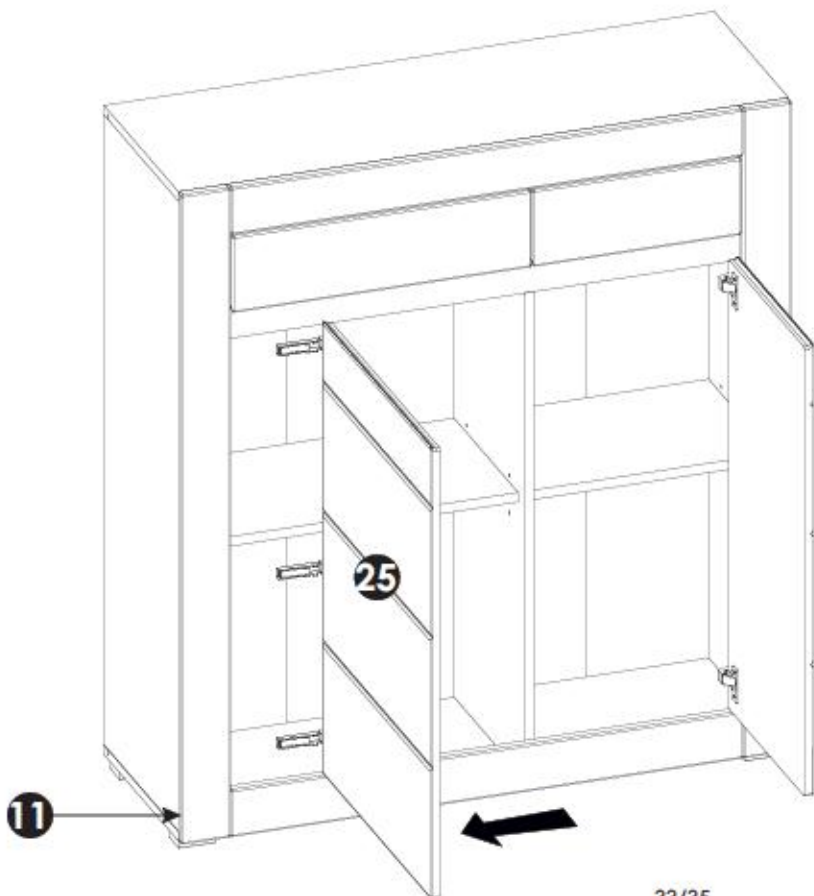
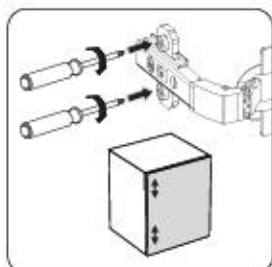
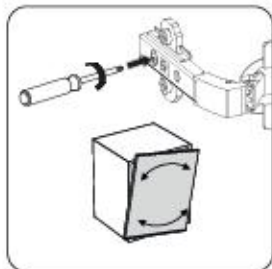
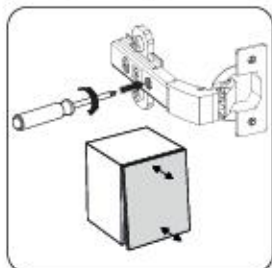
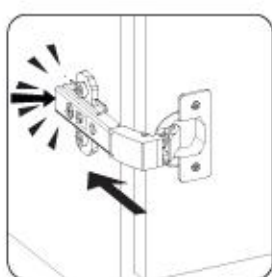
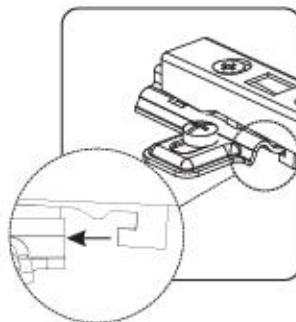

51 ▶

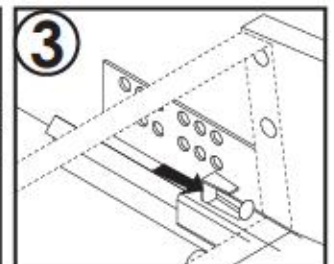
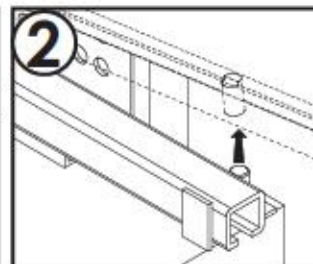
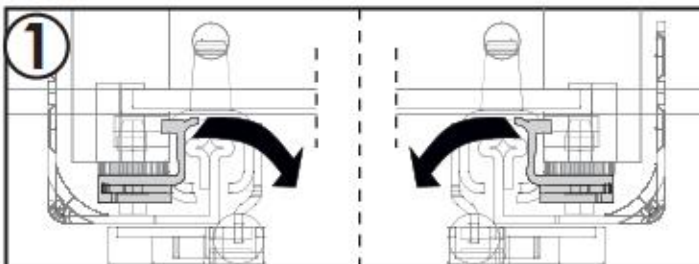
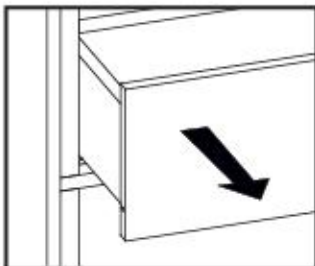
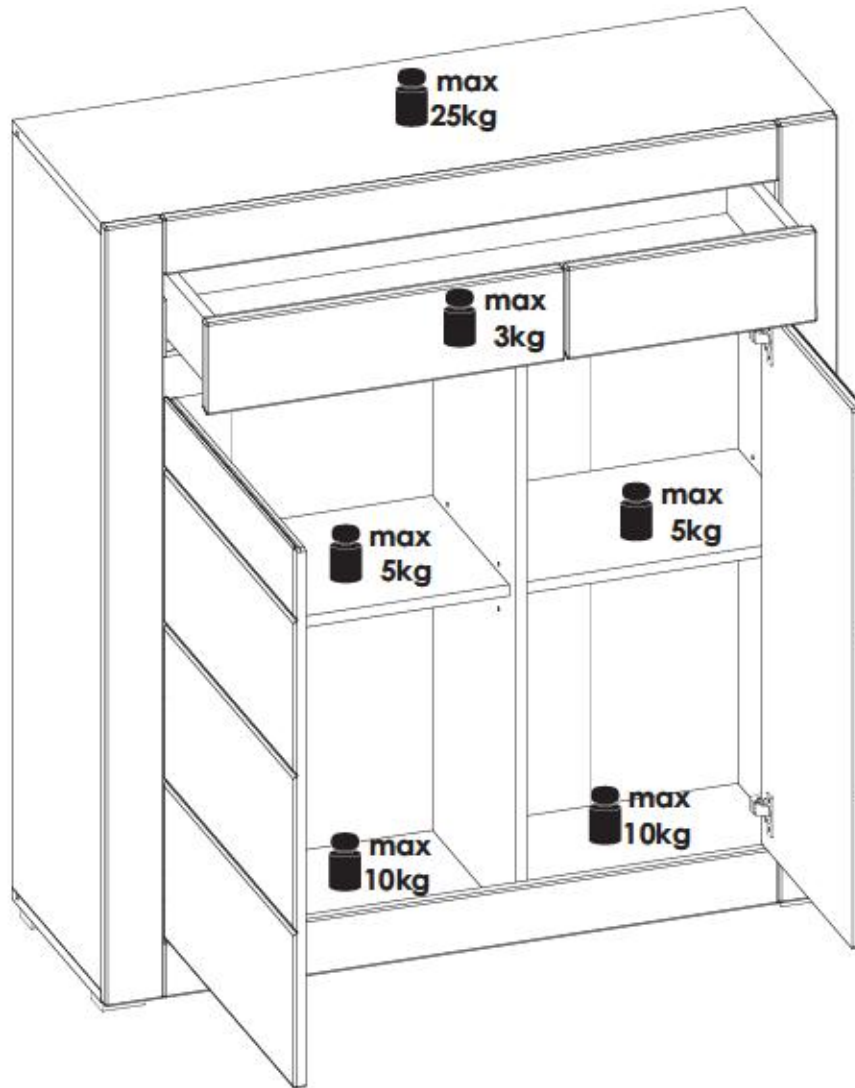

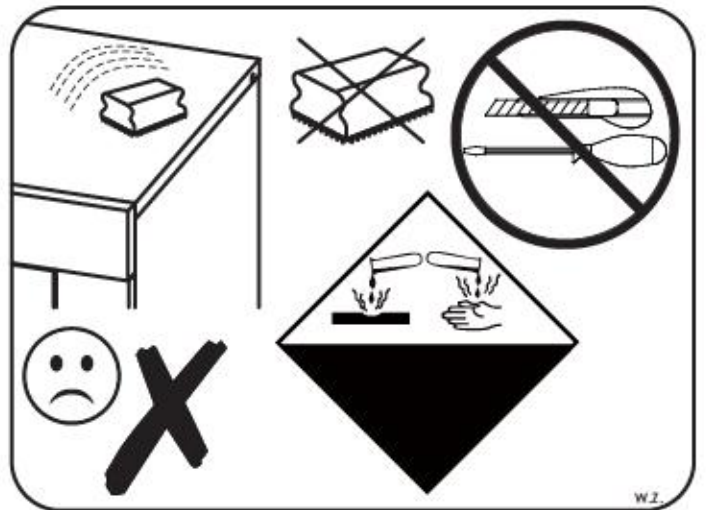
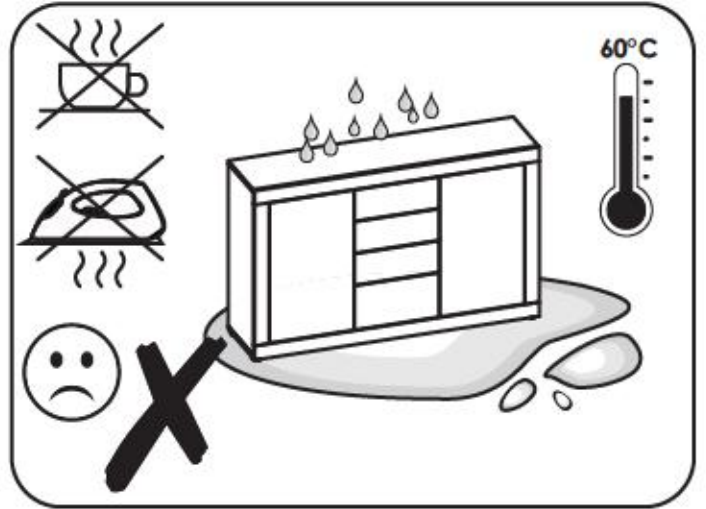
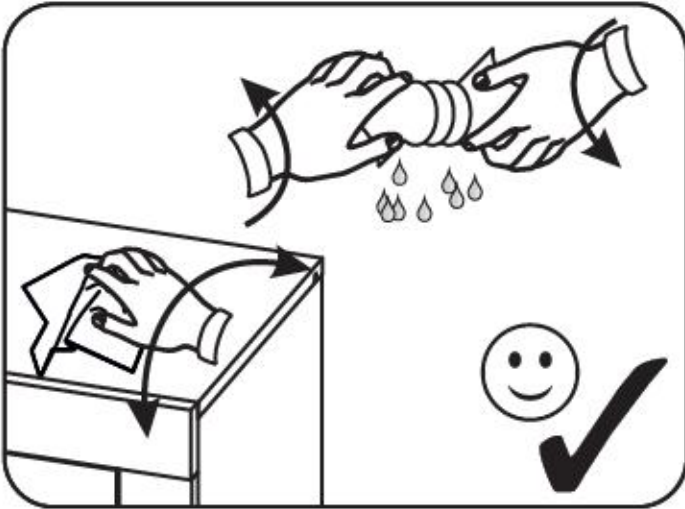
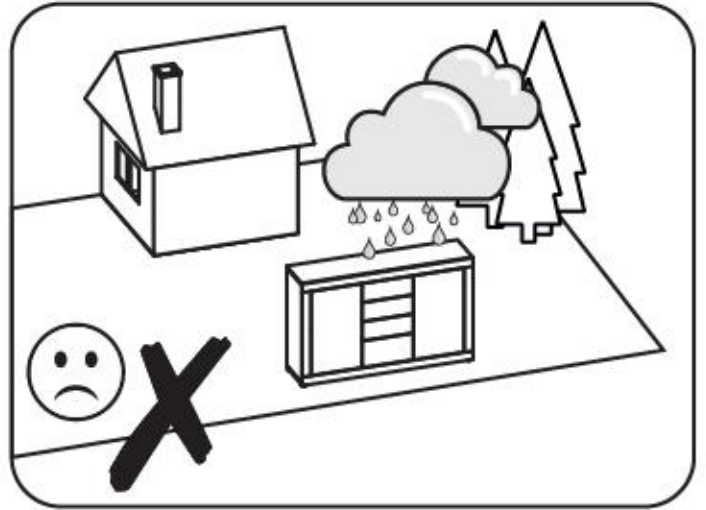
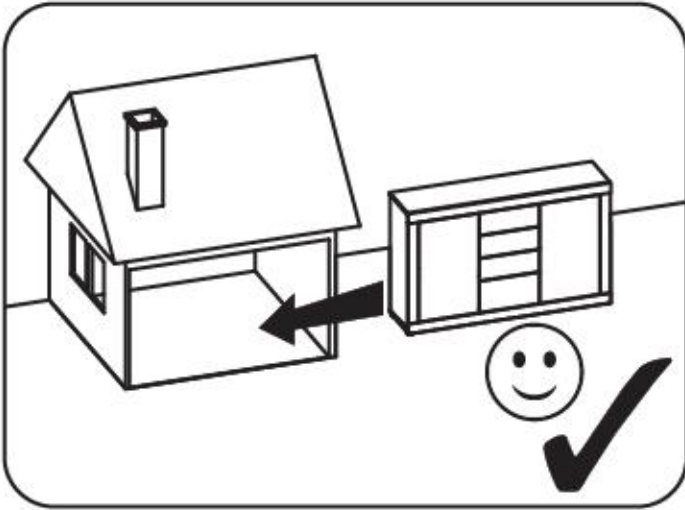

245FCA70

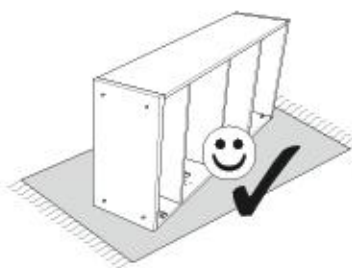
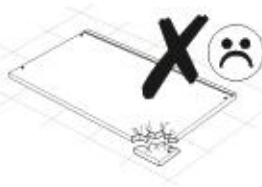
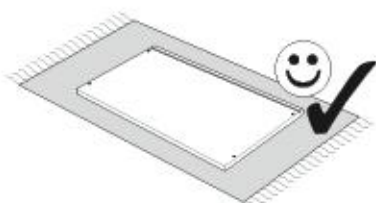
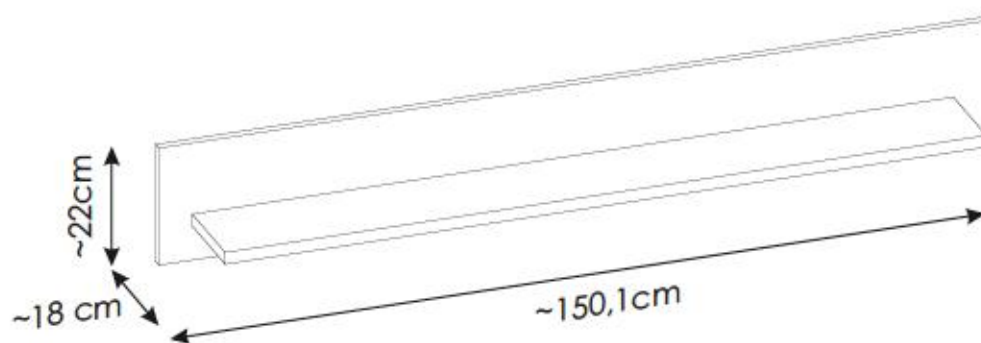

ملاحظة!

يجب تثبيت الأثاث بإحكام إلى الحائط أو الجدار لتجنب خطر إنقلابه. لا تحتوي العلبة على مسامير التثبيت، إذ إنه ينبغي استعمال المسامير المخصصة لنوعية الحائط أو الجدار. اختر المسامير التي تناسب جدارك.

PL.

UWAGA! Mebel należy trwale zamocować do ściany, aby uniknąć ryzyka związanego z przewróceniem się mebla. W paczce nie ma śrub mocujących, ponieważ rodzaj mocowania należy odpowiednio dobrać do rodzaju ściany. Dobierz właściwe do Twojego rodzaju ściany.

D.

ACHTUNG! Um alle mit dem Umkippen des Möbels verbundenen Risiken auszuschließen, muss das Möbel fest an der Wand verankert werden. Beschläge für die Wandbefestigung sind nicht beige packt, da diese von der jeweiligen Wandbeschaffenheit abhängig sind. Bitte solche Befestigungsschläge wählen, die für die heimischen Wände geeignet sind.

FR.

ATTENTION! Ce meuble doit être fixé en permanence au mur pour éviter les risques de chute. Les vis de fixation ne sont pas livrées car le type de fixation doit être choisi en fonction du type de mur. Sélectionnez les fixations adaptées au mur.

I.

ATTENZIONE! Il mobile deve essere permanentemente fissato alla parete per evitare i rischi derivanti da un ribaltamento del mobile. La confezione non include le viti di fissaggio, in quanto il tipo di fissaggio deve essere scelto in base al tipo di parete. Utilizzare viti appropriate in base al materiale della parete.

HR.

NAPOMENA! Namještaj mora biti trajno pričvršćen za zid, kako bi se izbjegao rizik od njegovog prevrtanja. U paketu nema vijaka za pričvršćivanje, jer se vrsta montaže mora prilagoditi vrsti zida. Odaberite pravu vrstu prema Vašoj vrsti zida.

EN.

WARNING! To prevent this furniture from tripping over, fix it to the wall permanently. Fixing devices are not included since different wall materials require different types of fixing devices. Please make sure you chose the correct ones for your type of wall.

SK.

POZOR! Nábytok musí byť trvalo pripevnený k stene tak, aby sa zamedzilo riziku prevrátenia. Balík neobsahuje upevňovacie skrutky, pretože typ upevnenia je treba vybrať podľa typu steny. Vyberte typ vhodný pre Vašu stenu.

CZ.

POZOR! Nábytek je nutné pevně připevnit ke zdi, abychom se vyhnuli riziku spojenému s jeho převrnutím. Součástí balení nejsou připevňovací šrouby, protože způsob připevnění je nutné zvolit podle druhu stěny. Vyberte správný pro Váš typ stěny.

RU.

ПРИМЕЧАНИЕ! Эту мебель необходимо всегда прикреплять к стене, чтобы избежать рисков, связанных с переворотом мебели. В пакете нет крепежных винтов, потому что тип крепления должен быть выбран в соответствии с типом стены. Выберите, пожалуйста, правильные винты к вашей стене.

RO.

ATENȚIE! Mobila trebuie ancorată permanent în perete pentru a evita riscul de răsturnare a mobilei. În pachet nu sunt incluse șuruburile de fixare, deoarece tipul de ancoraj trebuie ales în funcție de tipul de perete. Alegeți șuruburile potrivite pentru tipul Dvs. de perete.

TR.

DİKKAT! Devrime riskini önlemek için mobilya duvara sabitlemelidir. Sabitleme civataları pakete dahil değildir, çünkü sabitleme tertibatının tipi, duvara tipine uygun olarak seçilmelidir. Onu duvannızın tipine göre seçiniz.

E.

¡ATENCIÓN! El mueble debe ser fijado permanentemente a la pared para evitar el riesgo relacionado con el vuelco del mueble. En el paquete no hay tornillos de fijación, ya que se debe elegir el tipo de fijación adecuado para el tipo de pared. Elija el apropiado para su tipo de pared.

CN.

注意！本家具需要固定在墙上以免倒塌。箱子里没有安装螺钉。因为安装方式需要根据墙的类型调整。请按您的墙类型选择合适的安装方式。

SLO.

POZOR! Pohištvo trajno pritrdite na steno, da preprečite tveganje, da se prevrne. V paketu ni pritrdilnih vijakov, saj je treba način pritrditve ustrezno izbrati glede na vrsto stene. Izberite način, ki je ustrezen za vašo steno.

HU.



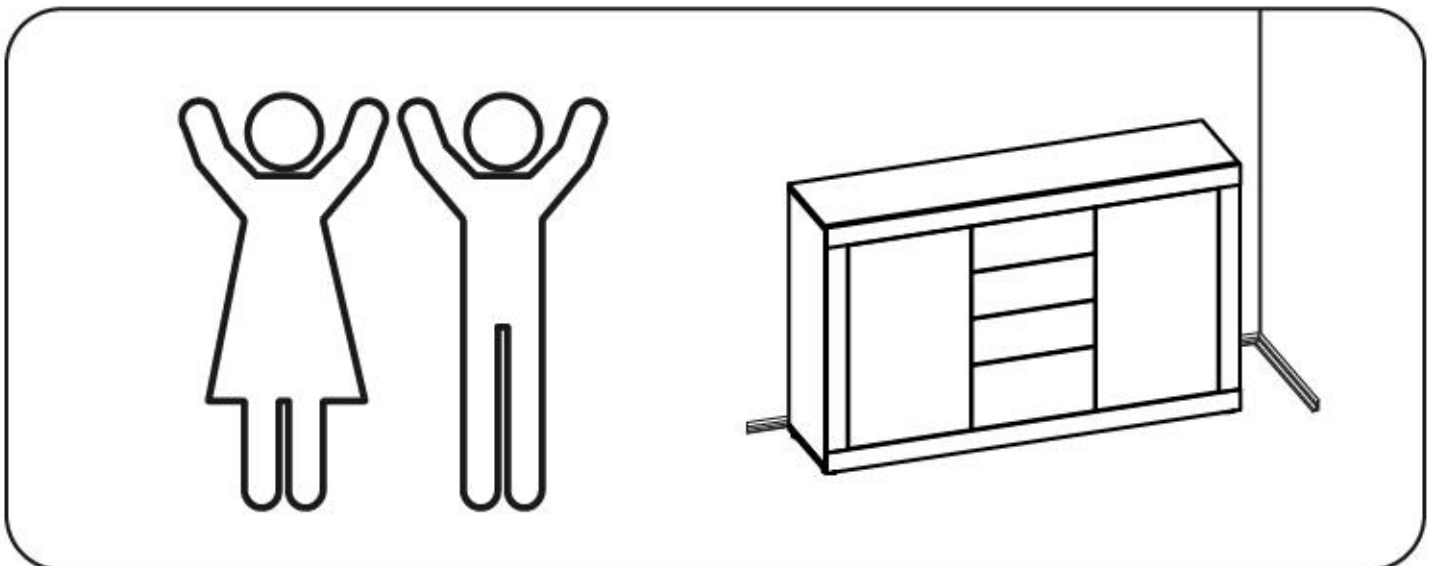
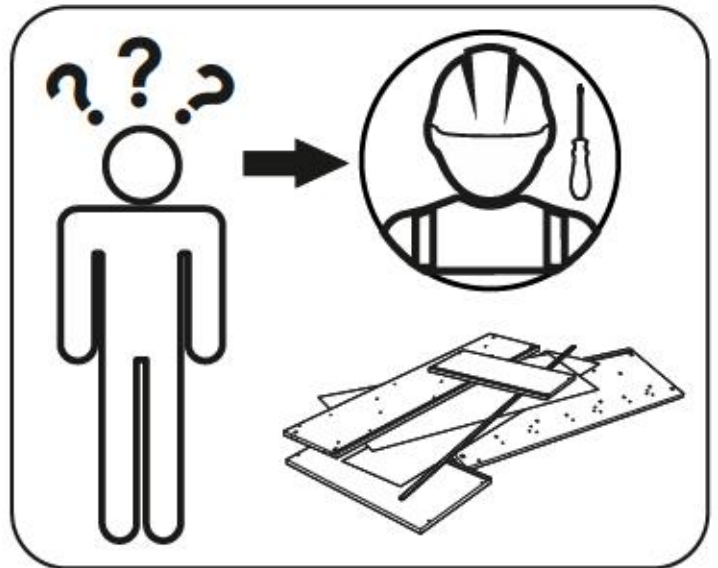
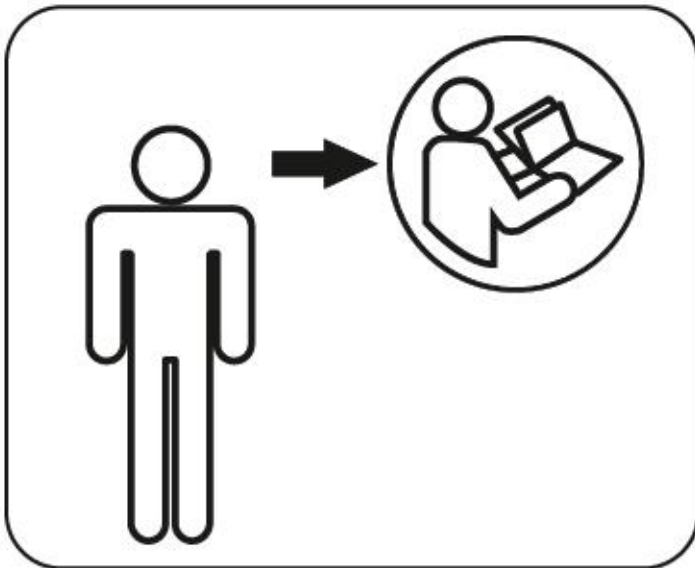
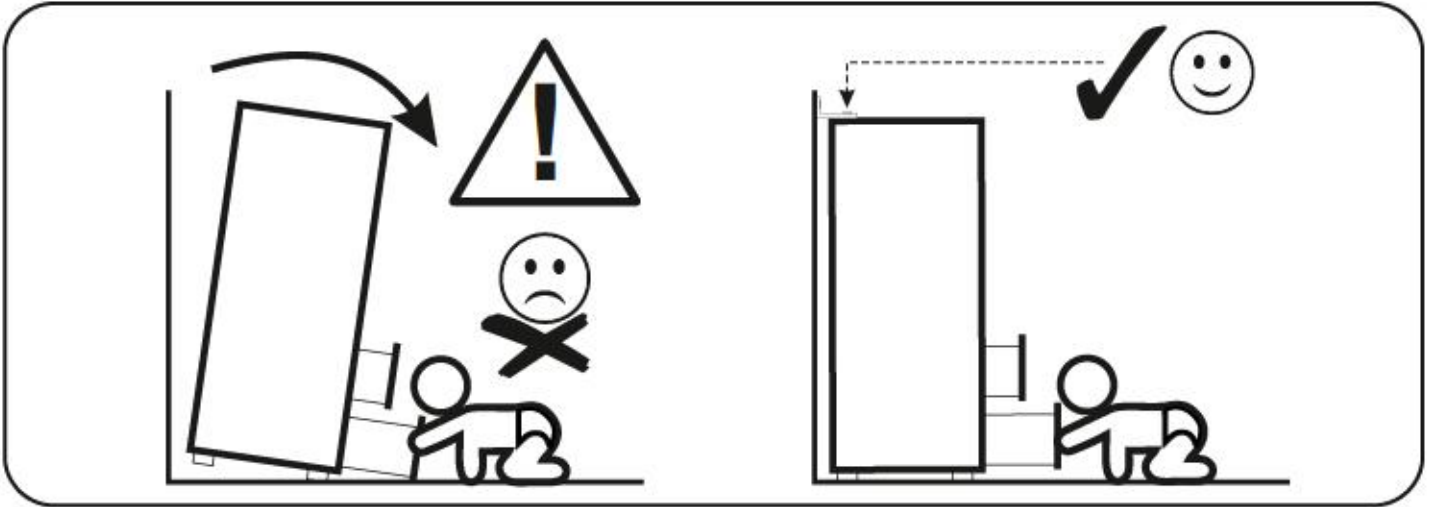
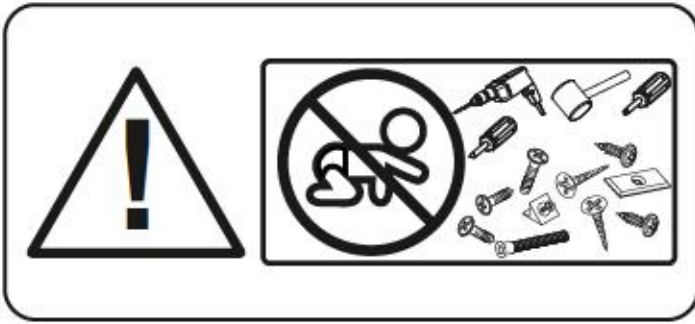

FIGYELEM! Rögzítse a bútorokat a falhoz, hogy elkerülje a bútor felborulásának kockázatát. A készletben nem találhatóak rögzítőcsavarok, mivel a rögzítés típusa a fal típusától függ. Válassza ki a fal típusának megfelelő kötőelemeket.

NL.

OPMERKING! De meubelen moeten permanent aan de muur worden bevestigd om te voorkomen dat de meubelen kantelen. Er zitten geen bevestigingsschroeven in het pakket, omdat het type bevestiging moet worden gekozen op basis van het type muur. Kies de juiste voor uw type muur.

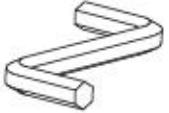

245FCA70

A1 8 x 35 mm x8 	C2 5 x 13 mm x6 	G2 7 x 60 mm x4 
M  x1	P1  x3	R7  x2

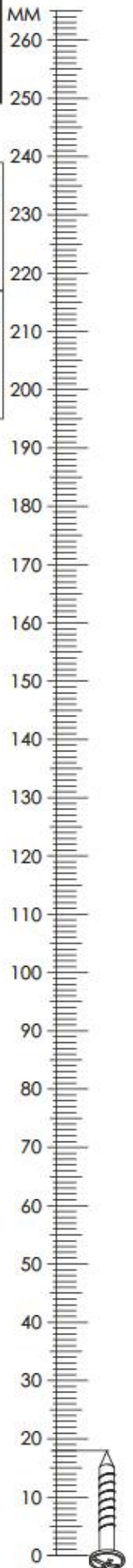

245FCA70

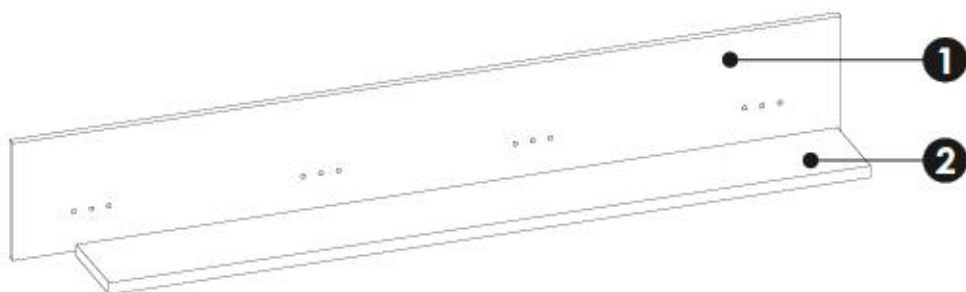

1	1501	220	16	x1	1/1
2	1380	164	22	x1	1/1

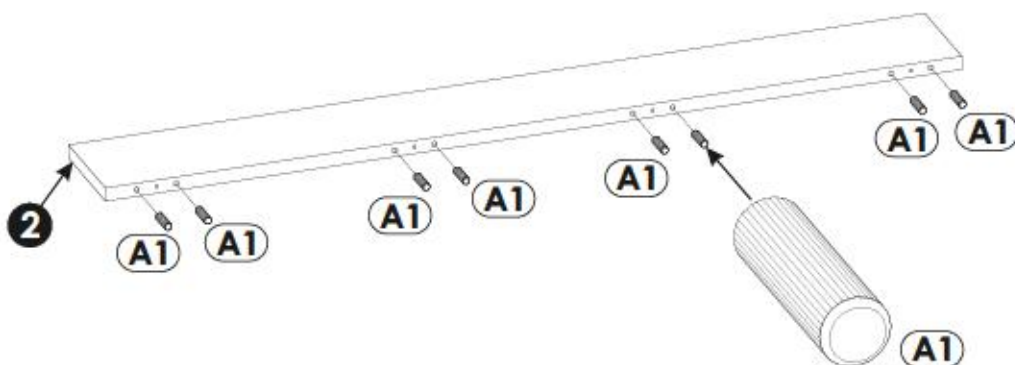
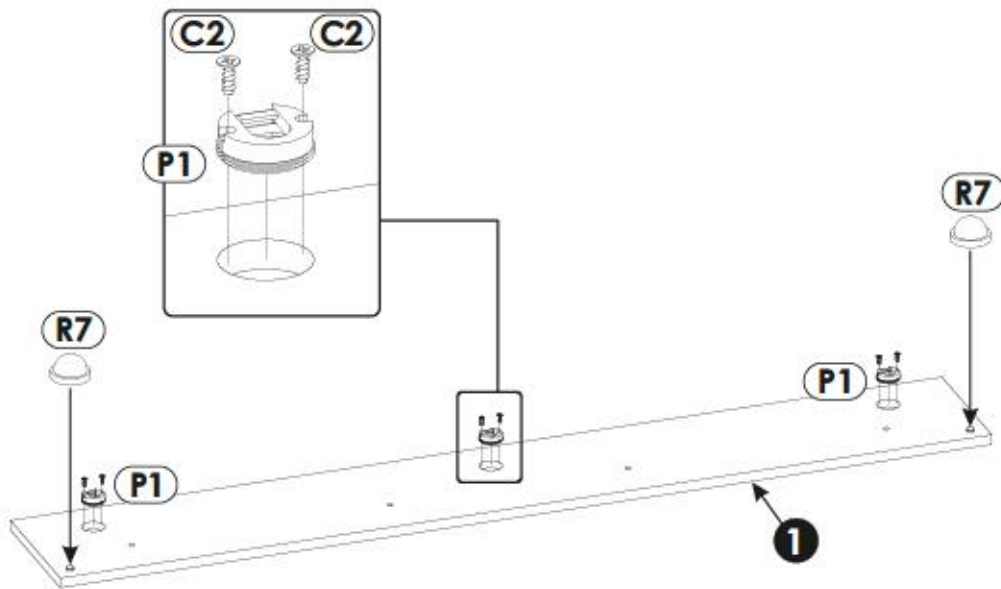
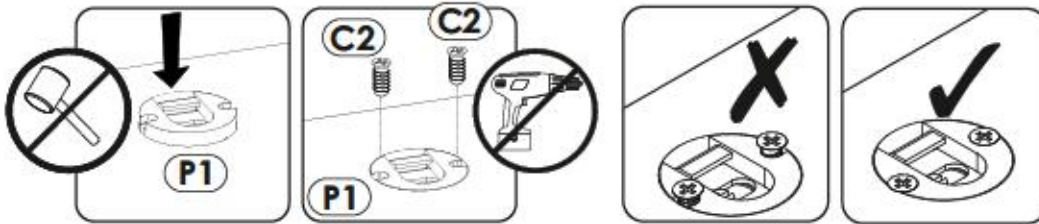
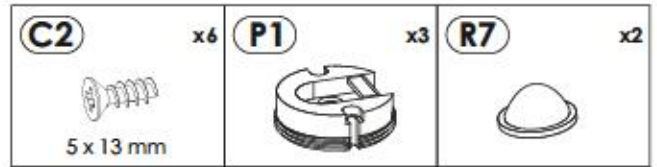

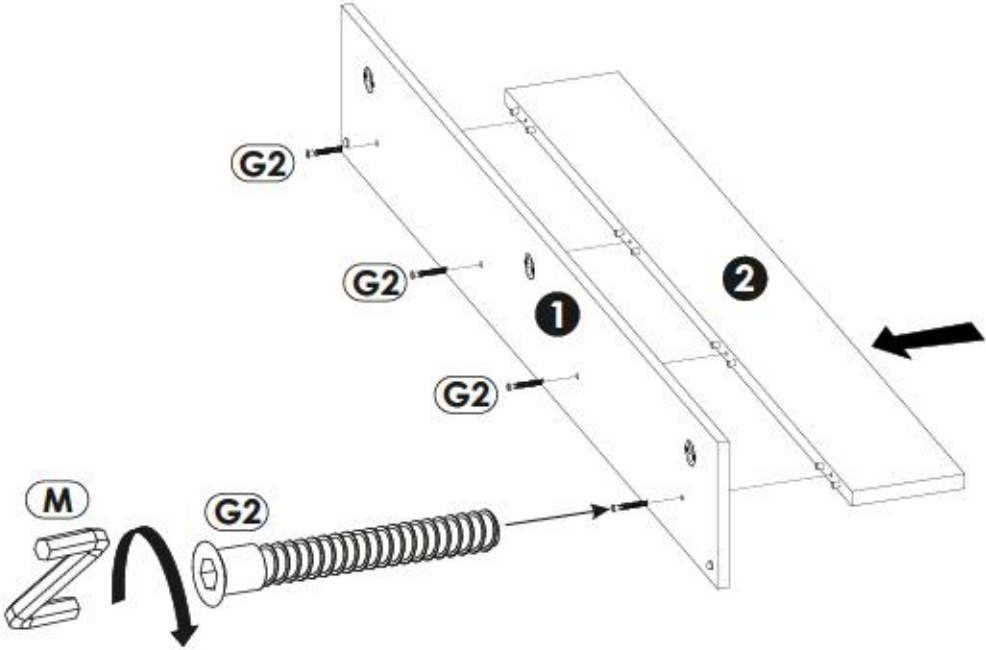
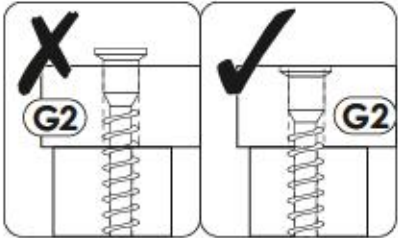

4

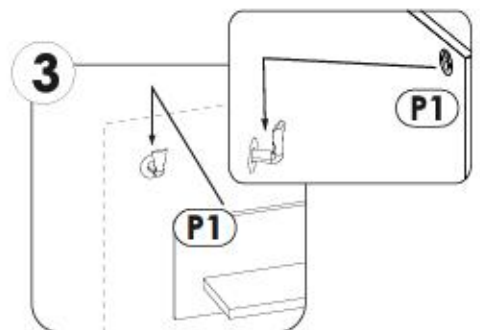
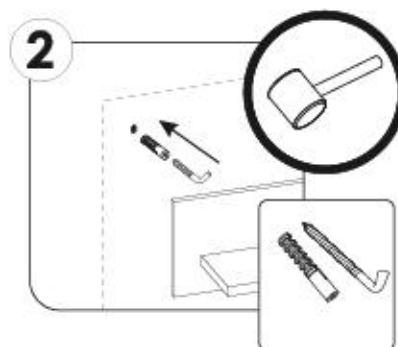
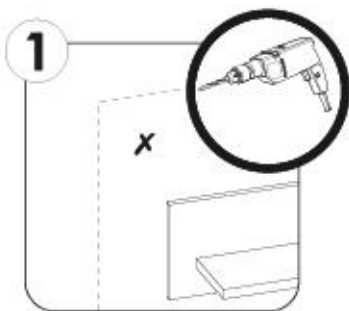
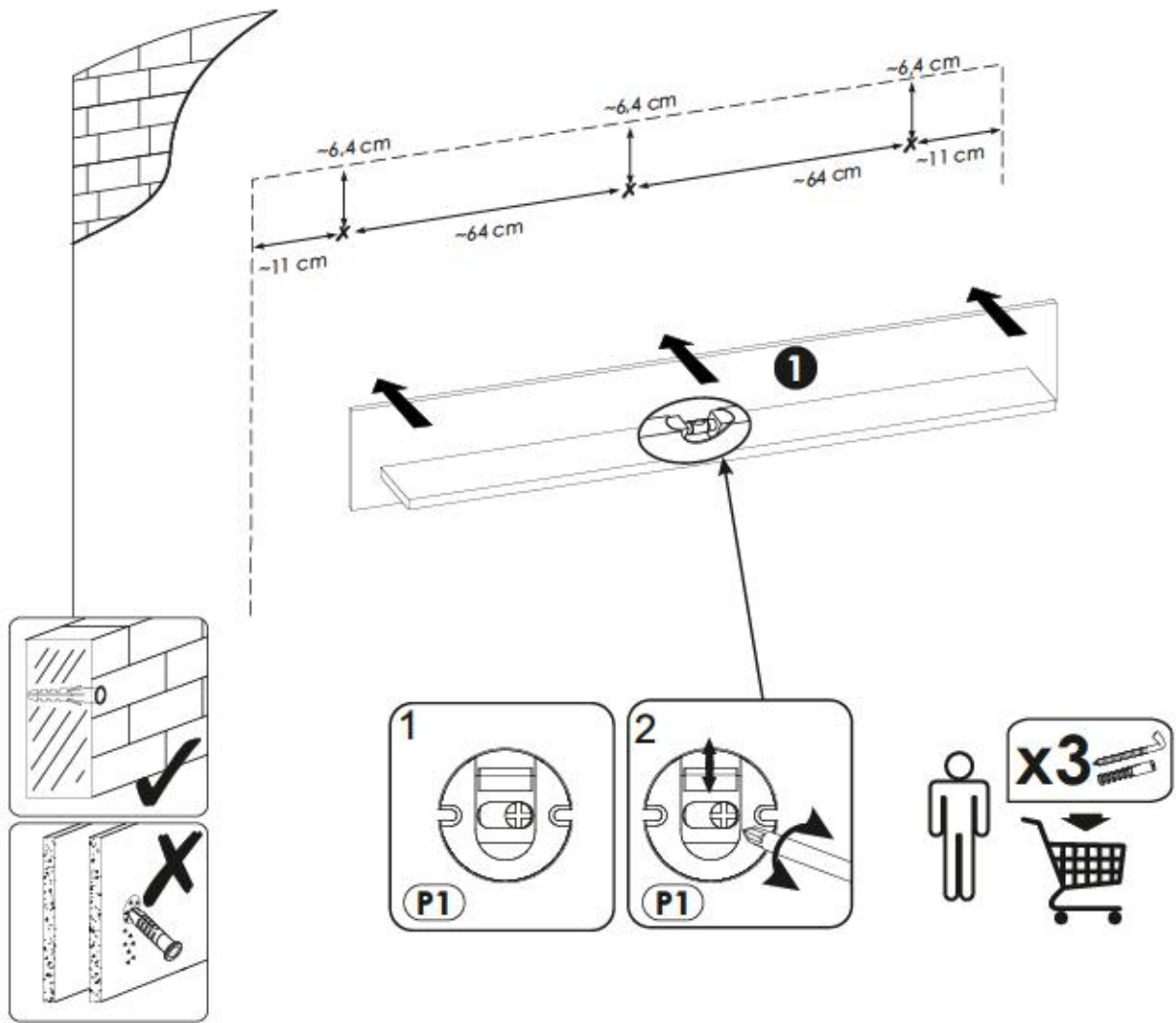

5▶

