

Trade Point Germany GmbH  
Am Bahnhof 14  
D- 26655 Westerstede

**D-** Montageanleitung

**GB-** Assembly instructions

**F-** Instructions de montage

**PL-** Instrukcja montażu

**RU-** Инструкция по монтажу

**NL-** Montagehandleiding

**TR-** Montaj talimatı

**RO-** Instrucțiuni de montaj

**IT-** Istruzioni per il montaggio

**SK-** Návod na montáž

**CZ-** Návod k montáži

**HU-** Szerelési útmutató

**BG-** Ръководство за монтаж

**P-** Instruções de montagem

**ES-** Instrucciones de montaje

**SRB-** Uputstvo za montažu

**SLO-** Navodila za vgradnjo

**HR-** Upute za montažu

**LT-** Montavimo instrukcija

**LV-** Montāžas instrukcija

**EST-** Montaažijuhend

**S-** Monteringsanvisning

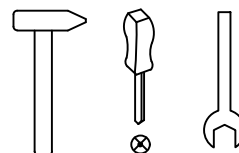
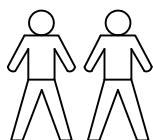

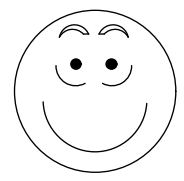
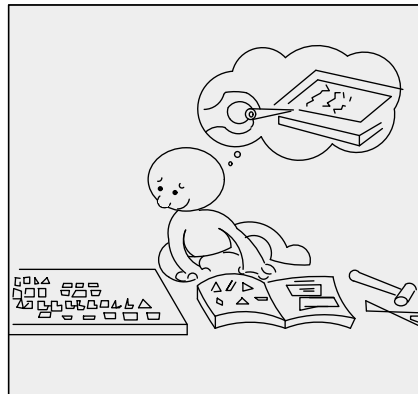
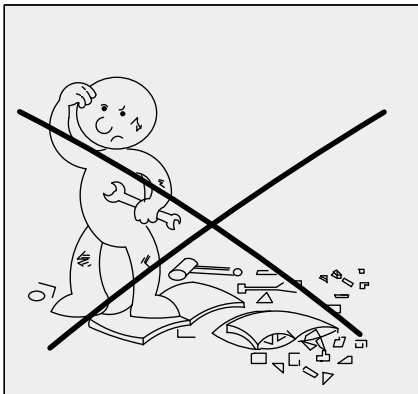
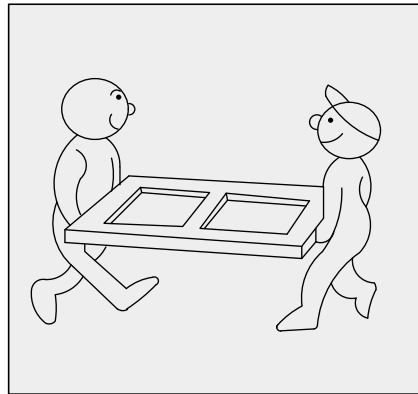
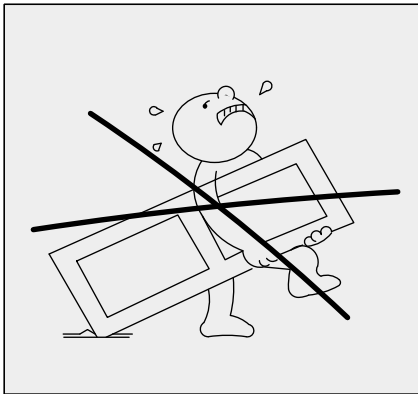
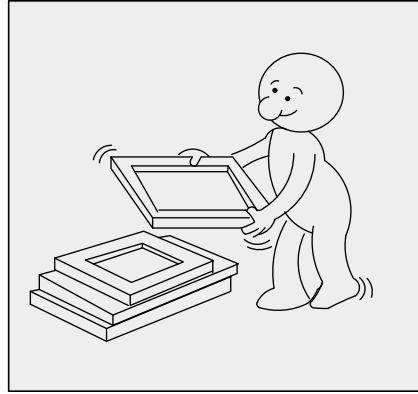
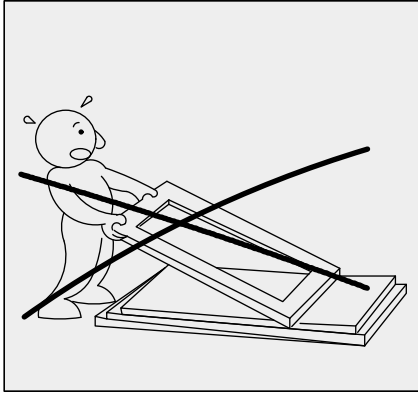
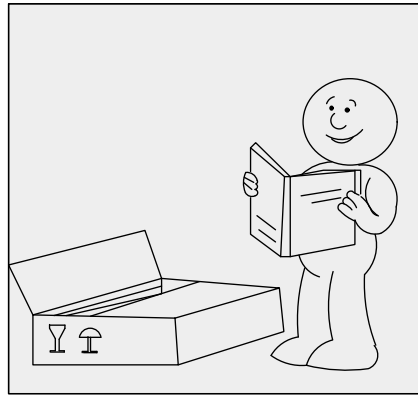
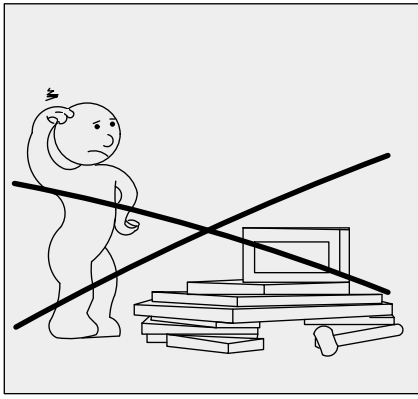

Servicekarte/ Сервизна карта/ Carte service/ Servisní karta/ Service card/ Tarjeta de servicio/  
 Servisna kartica/ Teeninduskaart/ Szervizlevél/ Servis karti/ Scheda di servizio/ Techninės  
 priežiūros kortelė/ Servisa karte/ Servicekaart/ Servisna kartica/ Cartão de serviços/ Karta  
 serwisowa/ Carte de service/ Сервис-карта/ Servicekort/ Servisna kartica/ Servisná karta

LINA TABLE

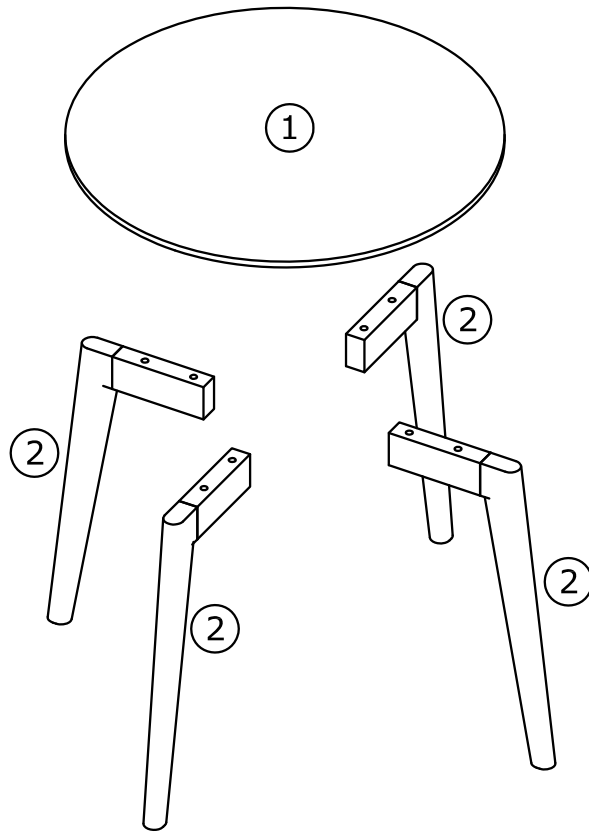

A ( 8 )

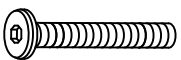

M6x50 mm

B ( 8 )



M6

C ( 8 )



M6

D ( 4 )

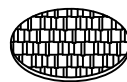





E ( 1 )

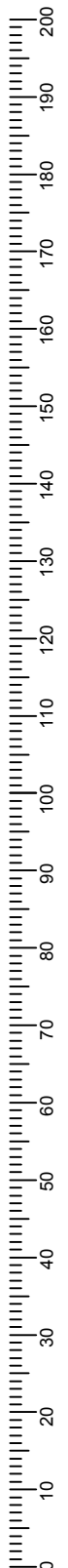

M4

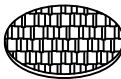

1	<b>A (8)</b>  M6x50 mm	<b>B (8)</b>  M6	<b>C (8)</b>  M6	<b>D (4)</b> 	<b>E (1)</b>  M4
---	---	---	---	---	---

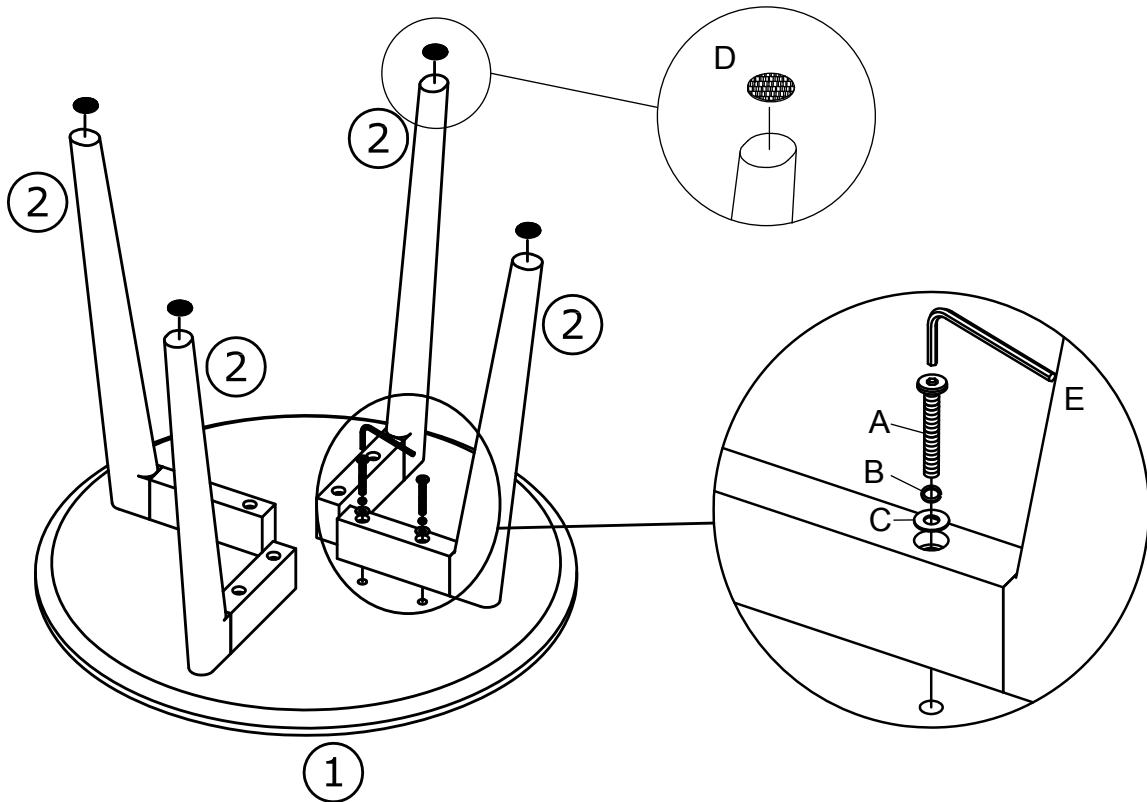

2

