

# Sophia

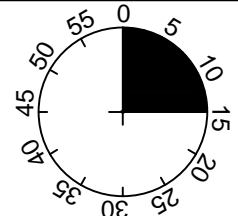

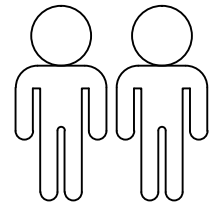

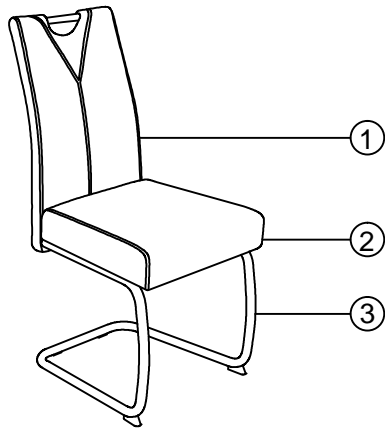



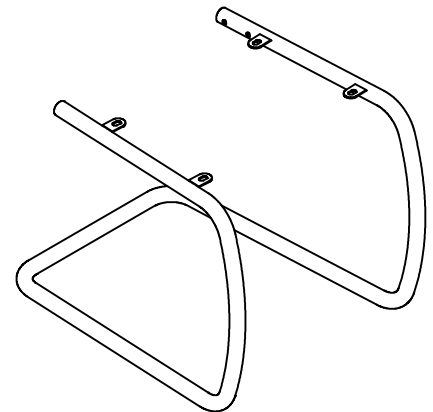
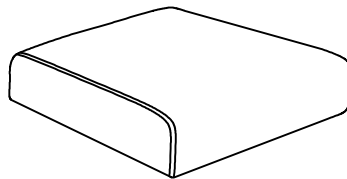

1

2

3







1	1 x
2	1 x
3	1 x

<b>A</b>	M6X20  4x	<b>B</b>	M8x20  4x	<b>C</b>	Ø18xØ8x1.5  4x	<b>D</b>	Ø18xØ6x1.5  4x	<b>E</b>	M8  4x	<b>F</b>	4MM  1x
<b>G</b>	6MM  1x	<b>H</b>	M4x20  4x	<b>I</b>	 2x						

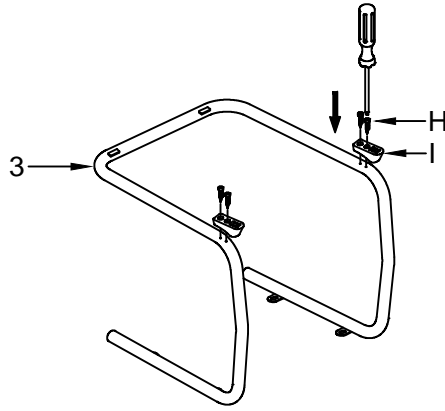
I.





1

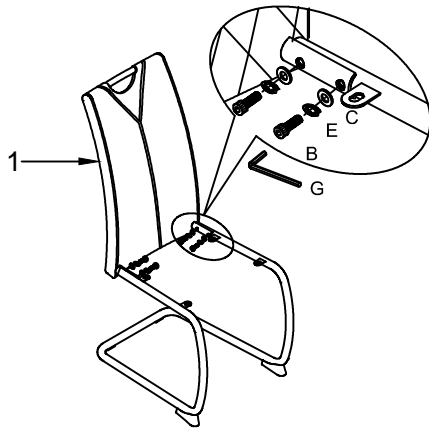

- H** M4x20  
 4x
- I**  2x
- 

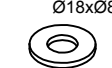

2



- B** M8x20  
 4x
- C** Ø18xØ8x1.5  
 4x
- E** M8  
 4x
- G** 6MM  
 1x
- 

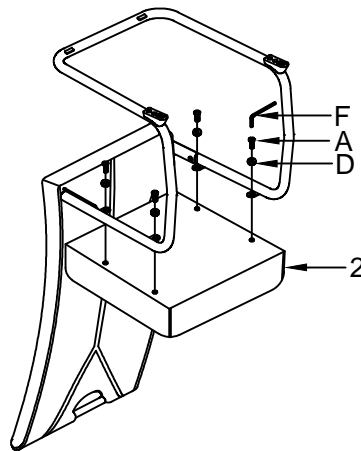

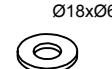
3

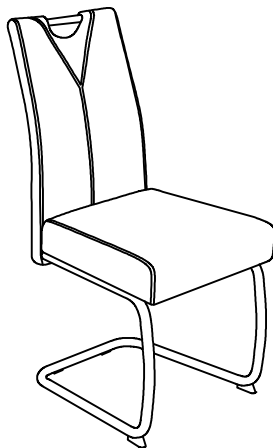

- A** M6x20  
 4x
- D** Ø18xØ6x1.5  
 4x
- F** 4MM  
 1x
- 

4



- F** 4MM  
 1x
- G** 6MM  
 1x
- 