

## Roswell

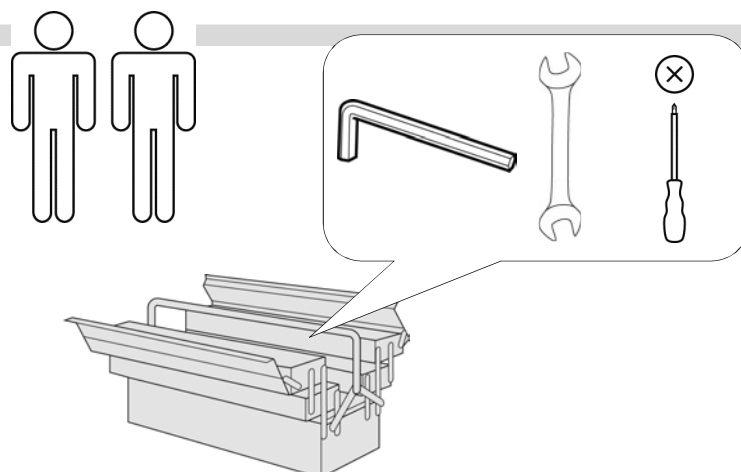

- |                                  |                                       |
|----------------------------------|---------------------------------------|
| <b>D</b> Montageanleitung        | <b>GB</b> Assembly instructions       |
| <b>FR</b> Notice de montage      | <b>NL</b> Handleiding voor de montage |
| <b>CZ</b> Montážní návod         | <b>IT</b> Istruzioni di montaggio     |
| <b>RO</b> Instrucțiuni de montaj | <b>RU</b> инструкция по сборке        |
| <b>PL</b> Instrukcja montażu     | <b>SK</b> Návod na montáž             |
| <b>HU</b> Szerelési útmutató     | <b>TR</b> Montaj talimatı             |

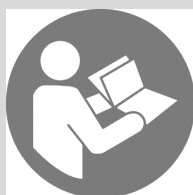

Bei der Montage Kopfteilbrett unbedingt beachten !

**Bettkasten  
Außenseite**

**Teil 4  
Bettseite-  
Innen**

Kopfteilbrett vor der Montage

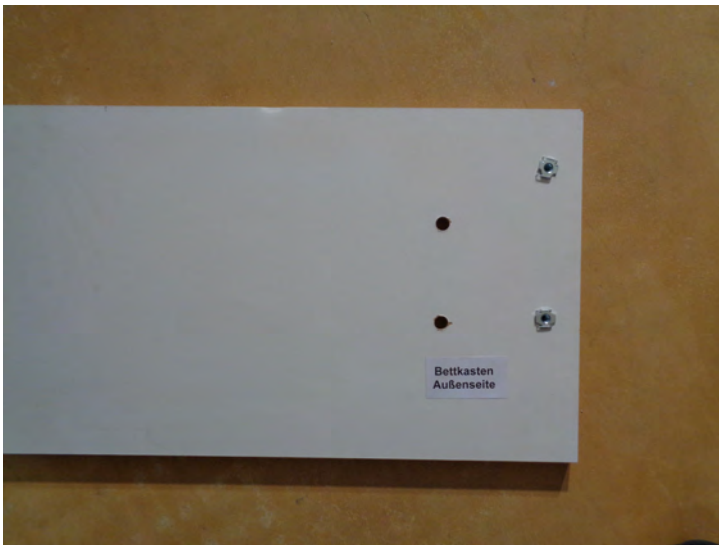

Kopfteilbrett nach der Montage



0  
10  
20  
30  
40  
50  
60  
70  
80  
90  
100  
110  
120  
130  
140  
150  
160  
170  
180  
190  
200

<b>Service • Assistenza • Dienstverlening • Serwis</b> <b>Servis • Szerviz • Сервисная служба</b>	
Name • Nom • Nome • Naam Nazwa • Jméno • Názov • Név Denumire • İsim • Название	<b>Roswell DB</b>
Nr. • No. • N° • Номер • Č • Sz	<b>SH43-51</b>
Typ • Type • Tip • Típus • Tipo Тип	<b>BK zerl.</b>

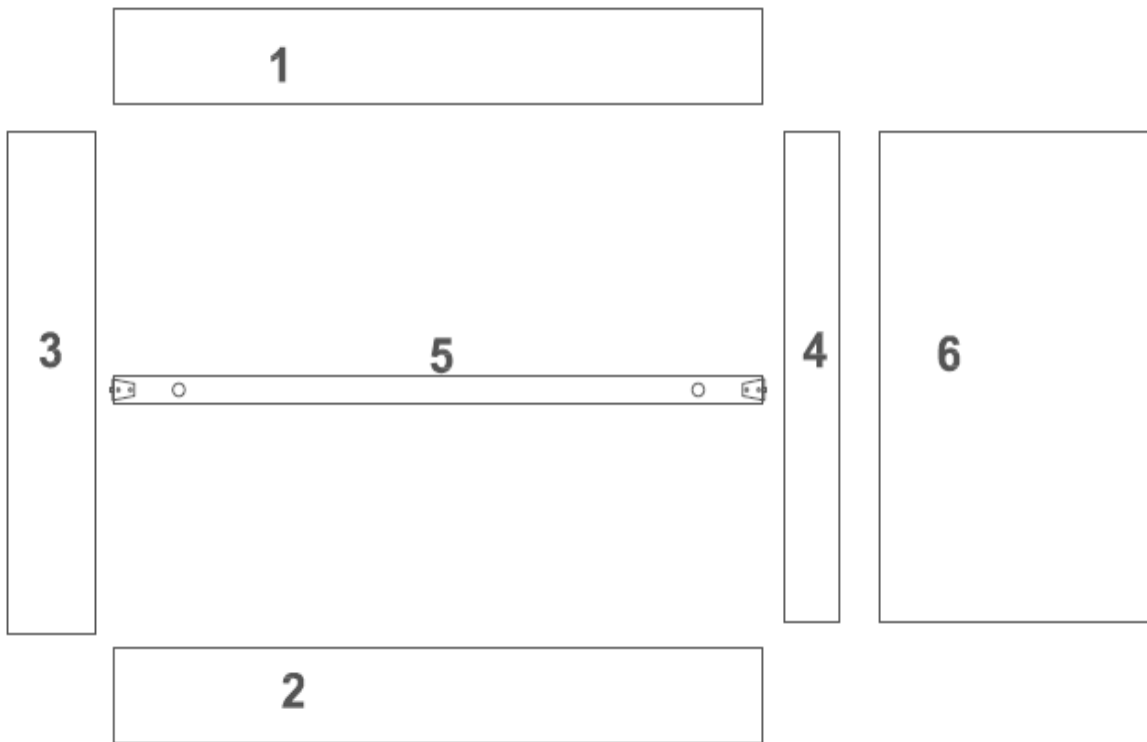





A	B	C	D	E	F
16x 6x25	4x	24x 3.5x20	6x	4x	2x

G	H	I
4x M8x20	4x 8x20	4x

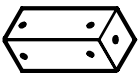
P	Q	R
4x 8x60	4x 8x40	4x M8

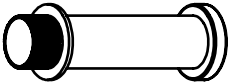

A		16x 6x25
B		4x
C		24x 3,5x20
D		6x
E		4x
F		2x

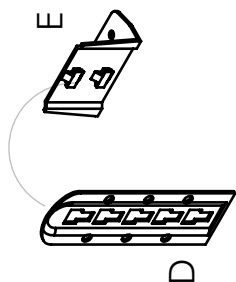
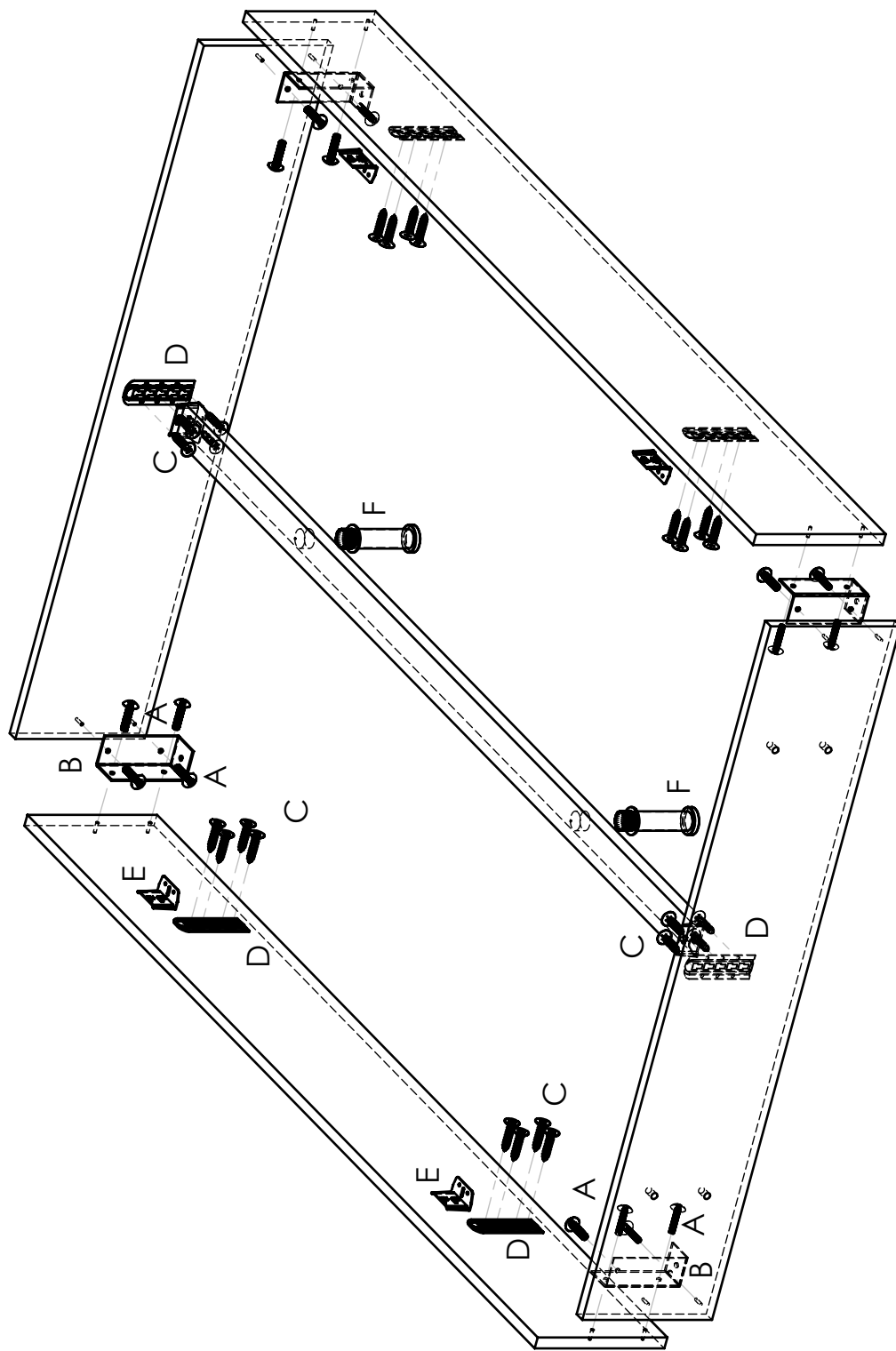

2.

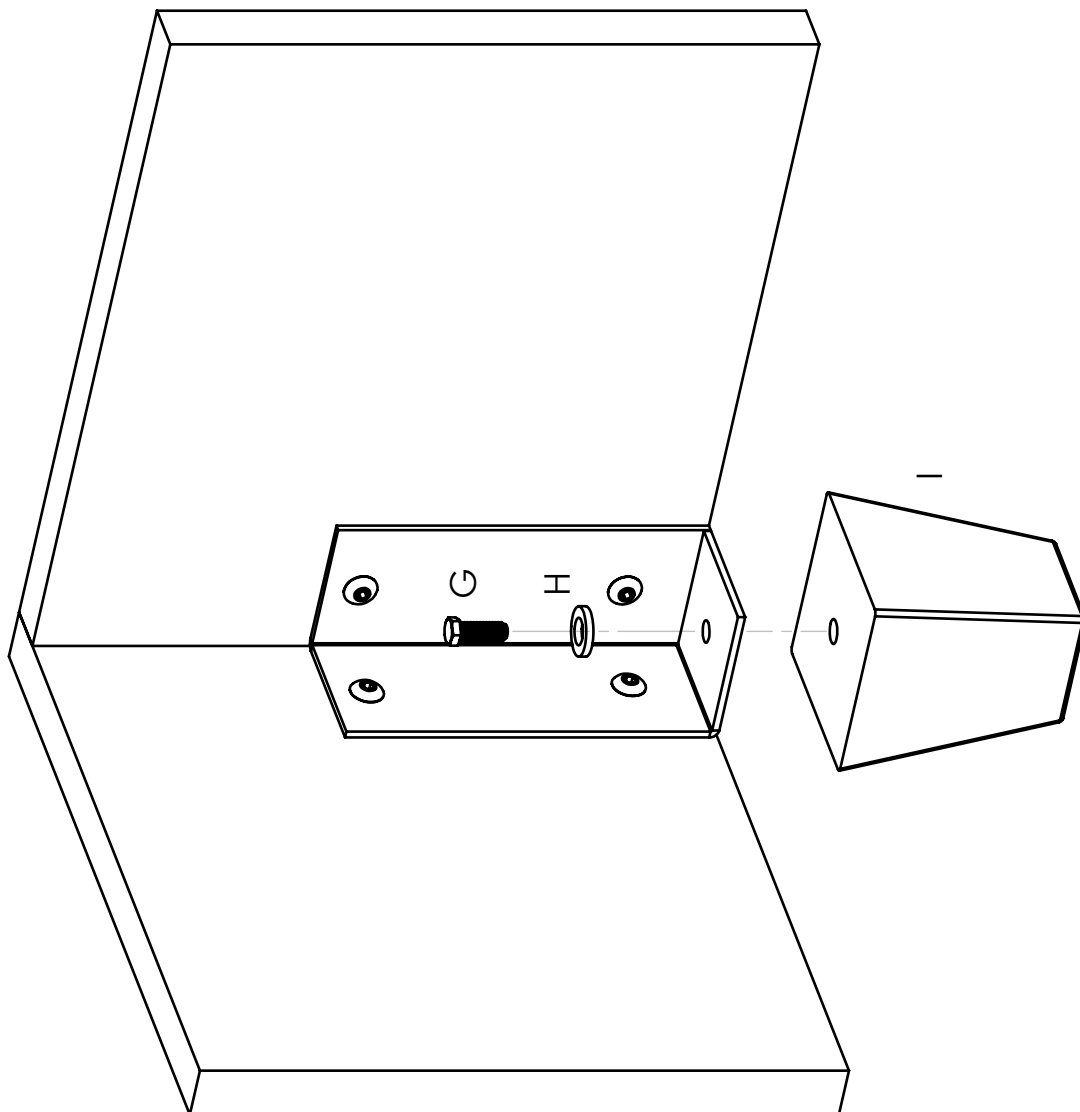

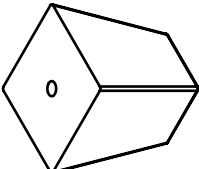
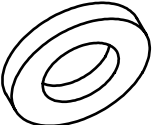
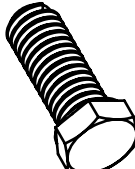

I		4x
H		4x 8x20
G		4x M8x20

3.

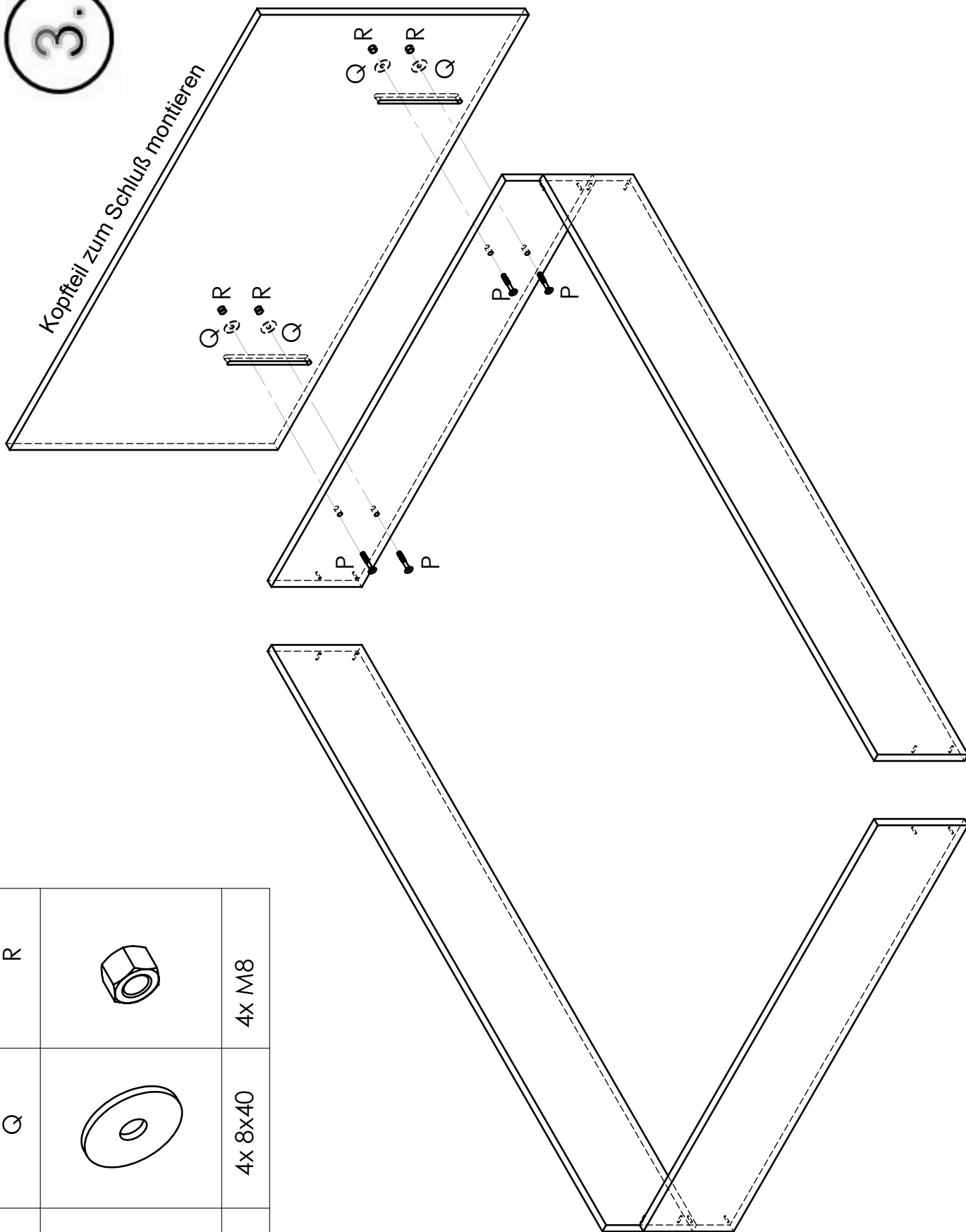
Kopfteil zum Schluß montieren

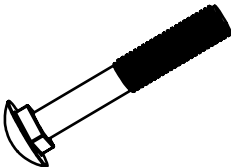
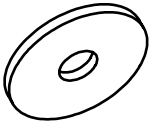

P		4x 8x60
Q		4x 8x40
R		4x M8