

# FACTORY ROUND

Glasdusche Runddusche

*Shower enclosure round*

90X90X200cm

**FAC282**

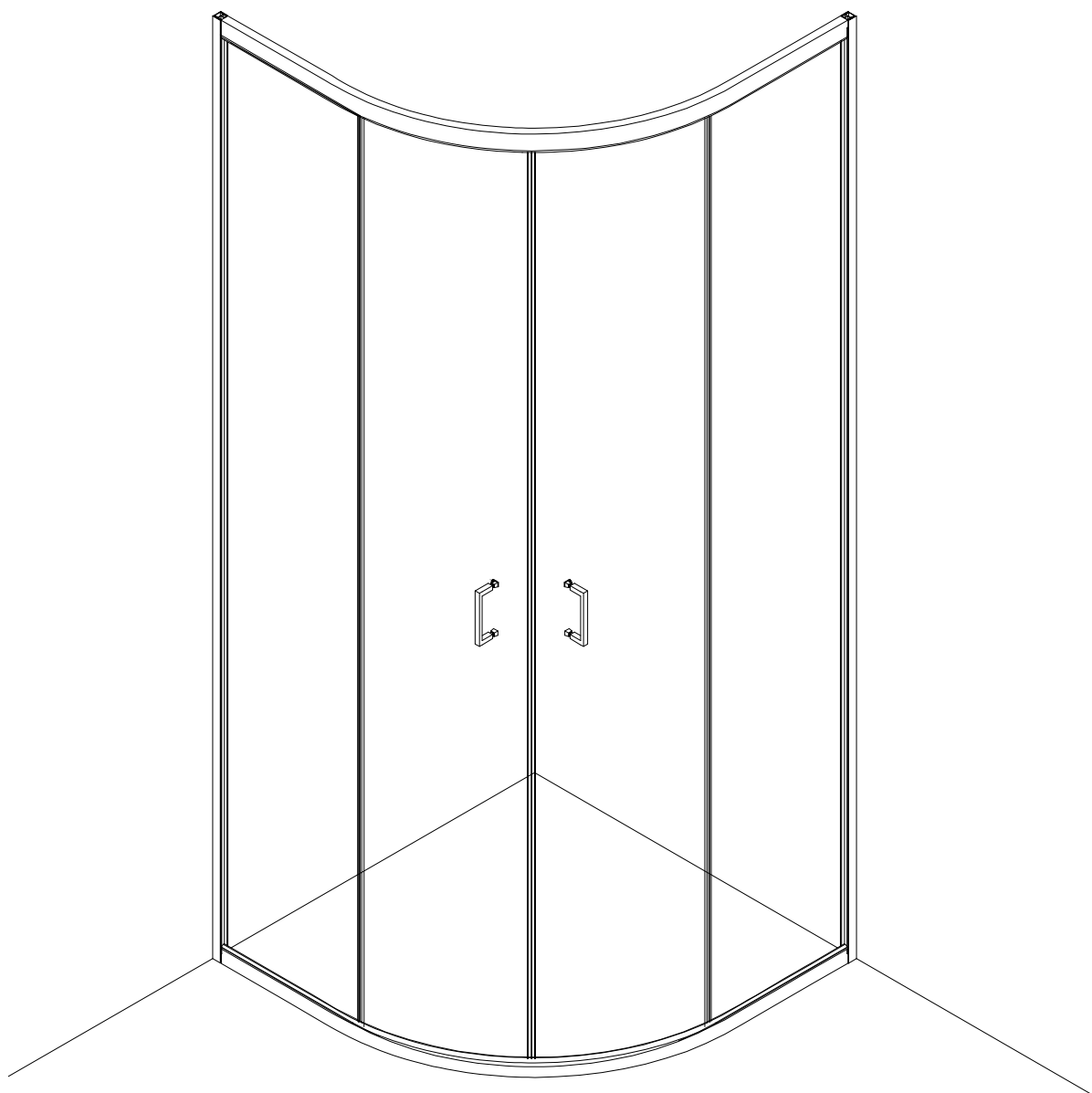

D



Vor dem Aufbau unbedingt durchlesen



## Garantie

- Die Produkte von AURLANE haben eine **Gewährleistung** von 1 Jahr nur auf die Ersatzteile. Da die Arbeit nicht von uns durchgeführt wird, gewährt AURLANE keinerlei Garantie auf die Arbeitsleistung. Im Fall eines Herstellungsfehlers oder eines defekten Kabinenteils können diese Elemente beim Händler bestellt werden, der diese Kabine verkauft hat, die Arbeitskosten für den Austausch dieses Teils werden aber in keinem Fall von AURLANE übernommen.
- Der Aufbau dieser Duschkabine muss durch eine Fachkraft für Sanitäranlagen erfolgen. Unser Unternehmen übernimmt keinerlei Haftung und behält sich das Recht vor, keine Garantie zu übernehmen, sollte das Produkt nicht von qualifiziertem Personal aufgebaut werden (die Installationsrechnung dient als Beweis). Im Fall einer Forderung in Bezug auf ein garantiertes Element muss unbedingt die Kaufrechnung des Produkts vorgewiesen werden.
- Es ist unbedingt nötig, den Zustand jedes Teils beim Auspacken zu überprüfen. Beanstandungen, hinsichtlich der Qualität des Produktes sind innerhalb einer Frist von 14 Tagen nach dem Kauf des Produktes einzureichen. Danach kann keine Gewährleistung mehr übernommen werden.

## Montage

- Wir möchten Sie darauf aufmerksam machen, dass der Aufbau von mindestens zwei Personen durchgeführt werden muss, damit die Elemente zugleich festgehalten und befestigt werden können.
- Die Glasteile bestehen auf Grund der Sicherheitsnormen aus Sekuritglas. Das Sekuritglas wird so hergestellt, dass es beim Aufprall in unzählige (nicht schneidende) Einzelteile explodiert, darum müssen diese Teile sehr vorsichtig gehandhabt werden. Aus dem gleichen Grund ist es zwingend notwendig, bei der Befestigung der Accessoires an den Gaselementen (Türgriffe, Tablett, Duschhalterung, Handtuchhalter usw.) Vorsicht walten zu lassen.

## Benutzung

- Um jeder bakteriellen Infektion vorzubeugen, ist es wichtig, die Duschkabine regelmäßig zu reinigen. Bitte beachten Sie dafür die Reinigungsempfehlungen und verwenden Sie nicht jede Art von Reinigungsprodukt.
- Achtung: Verwenden Sie keine Reinigungsmittel, die Azeton, Chlor oder Ammoniak enthalten. Die Verwendung solcher Produkte führt automatisch zu einer rapiden Abnutzung der Chromteile und einer Vergilbung der Acrylteile.



Carefully read before installation

## Warranty



- AURLANE products have a warranty of 1 year, which only applies to the spare parts. Because the work has not been performed by us, AURLANE does not provide any warranty on the work. In the event of a manufacturing defect or a faulty cubicle part, these elements can be ordered from the dealer who sold this cubicle. However, the labour costs involved in the replacement of this part are under no conditions covered by AURLANE.
- The assembly of this shower cubicle must be performed by a specialist for sanitary installations. Our company will not accept any type of liability and reserves the right not to accept warranty should the product be installed by unqualified personnel (the installation invoice acts as proof). The purchase receipt for the product must be provided in the event of a claim in regard to an element under warranty.
- It is absolutely necessary to verify the condition of each part when unpacking. No complaints in regard to the quality of the product will be accepted after a period of 14 days after the purchase of the product.
- We would like to call attention to the fact that the installation must be performed by at least two persons, ensuring that the elements can be held secure and mounted at the same time.
- Due to the safety standards, the glass parts are made of tempered safety glass. The tempered safety glass has been produced in such a manner that it explodes into numerous (non-cutting) pieces; therefore, these parts must be handled with particular care. For the same reason, it is absolutely necessary to act with great care during the mounting of the accessories to the glass elements (door handles, trays, shower head holder, towel rack, etc.).



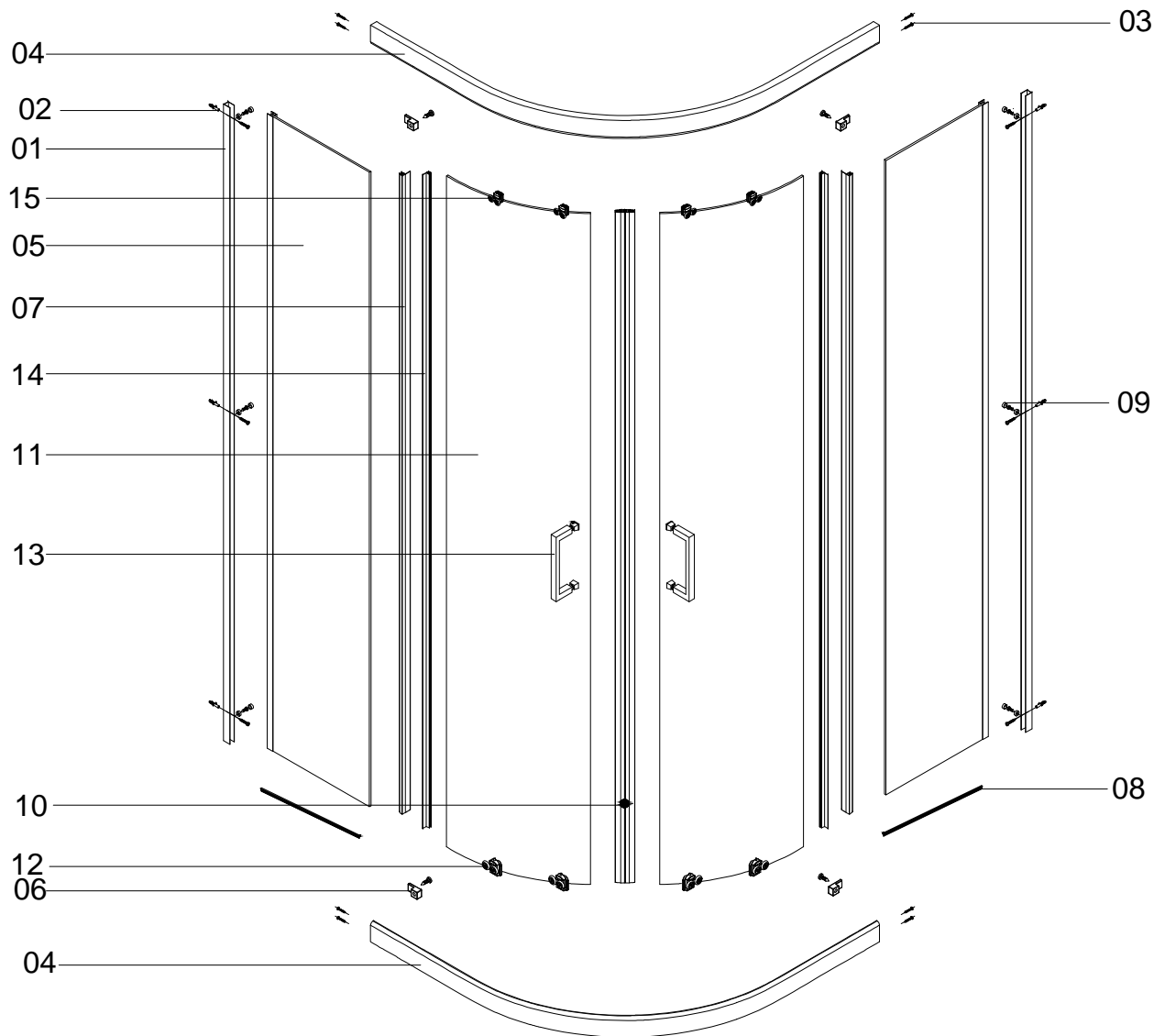

## Installation



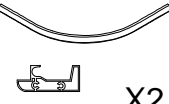
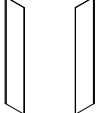
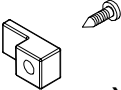

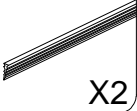

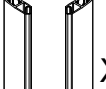
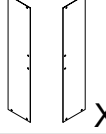

## Usage

- In order to prevent any bacterial infection, it is important to clean the shower cubicle regularly. For this, please observe the cleaning recommendations and note that not all types of cleaning products are suitable.
- Caution: Do not use cleaning agents that contain acetone, chlorine or ammonia. The use of such products will automatically cause rapid wear of the chrome parts and lead to the yellowing of the acrylic parts.



01 AURL961  X2	02 DE031  4X25 X6	03 DE031  3.5X25 X8	04  X2	05  X1	06 AURL832  X4
---	--	--	---	---	---

07 AURL301  X1	08 AURL722  X2	09 DE031  4X10 X6	10 AURL227  X1	11  X1	12 AURL956  X4
---	---	--	---	---	---

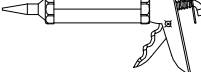
13 DE213  X2	14 AURL301  X1	15 AURL955  X4		 Ø3 Ø6				
---	---	---	---	--	---	---	---	---

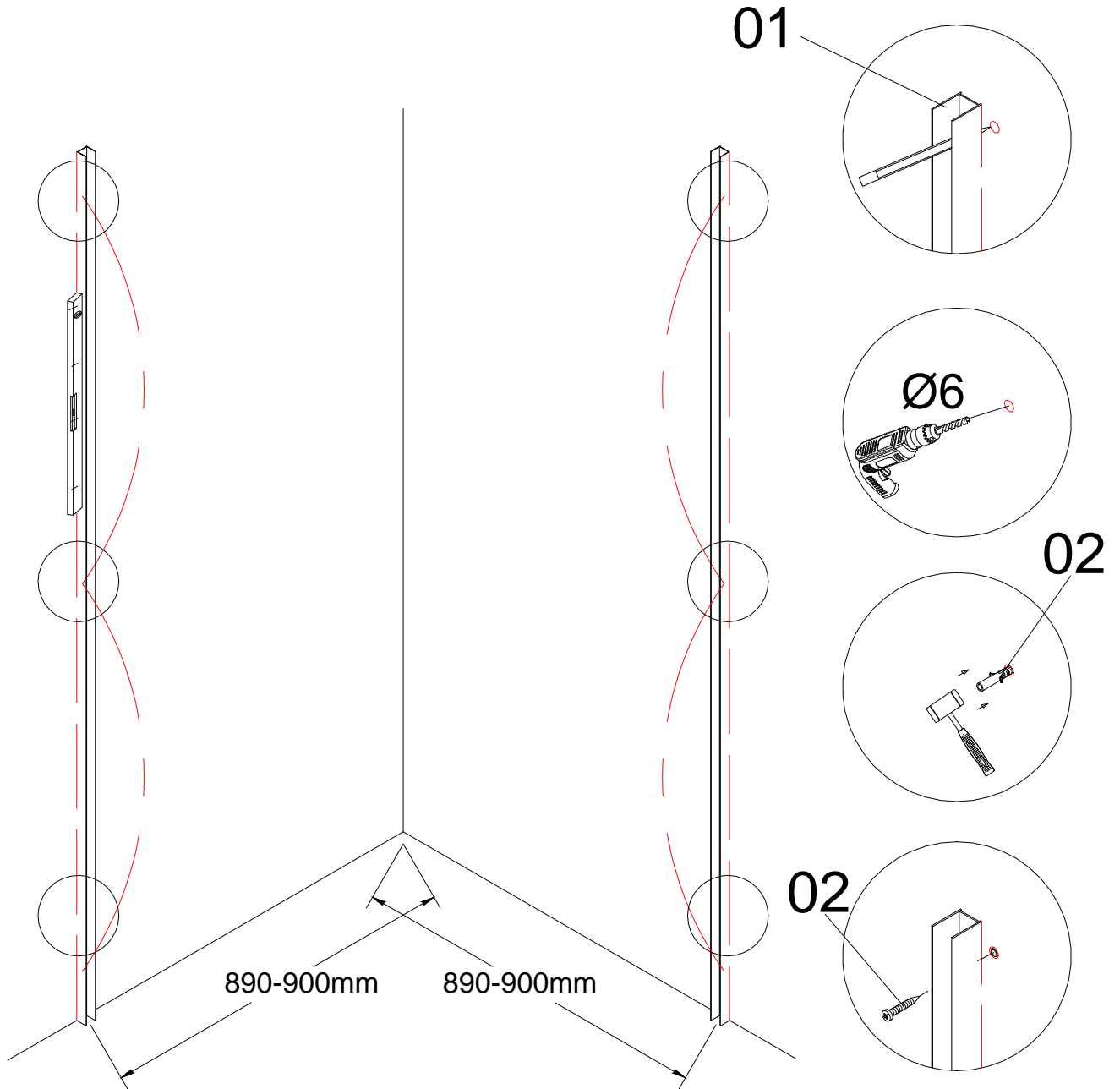
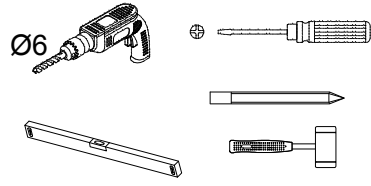
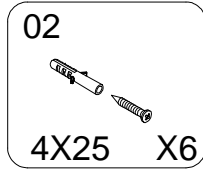
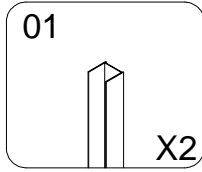

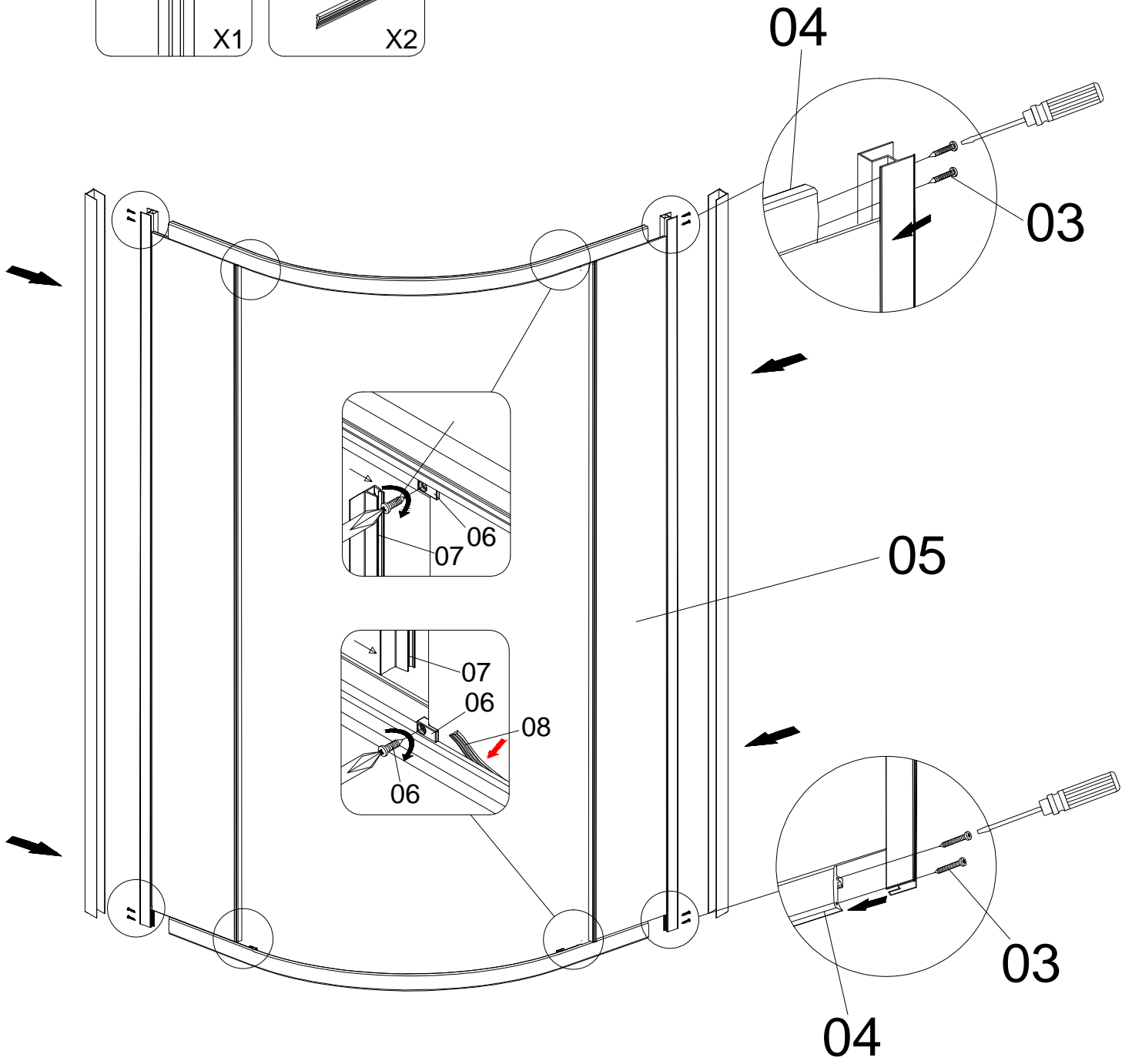
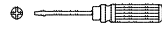
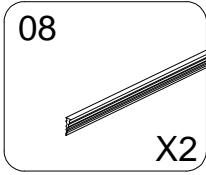
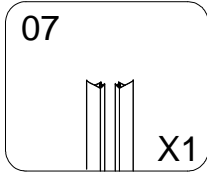
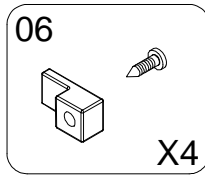
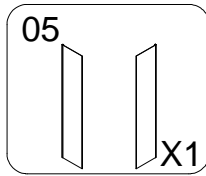
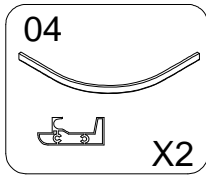
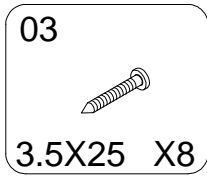

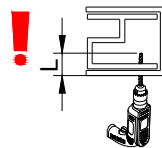
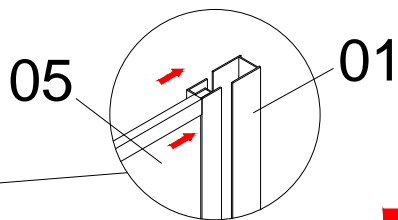
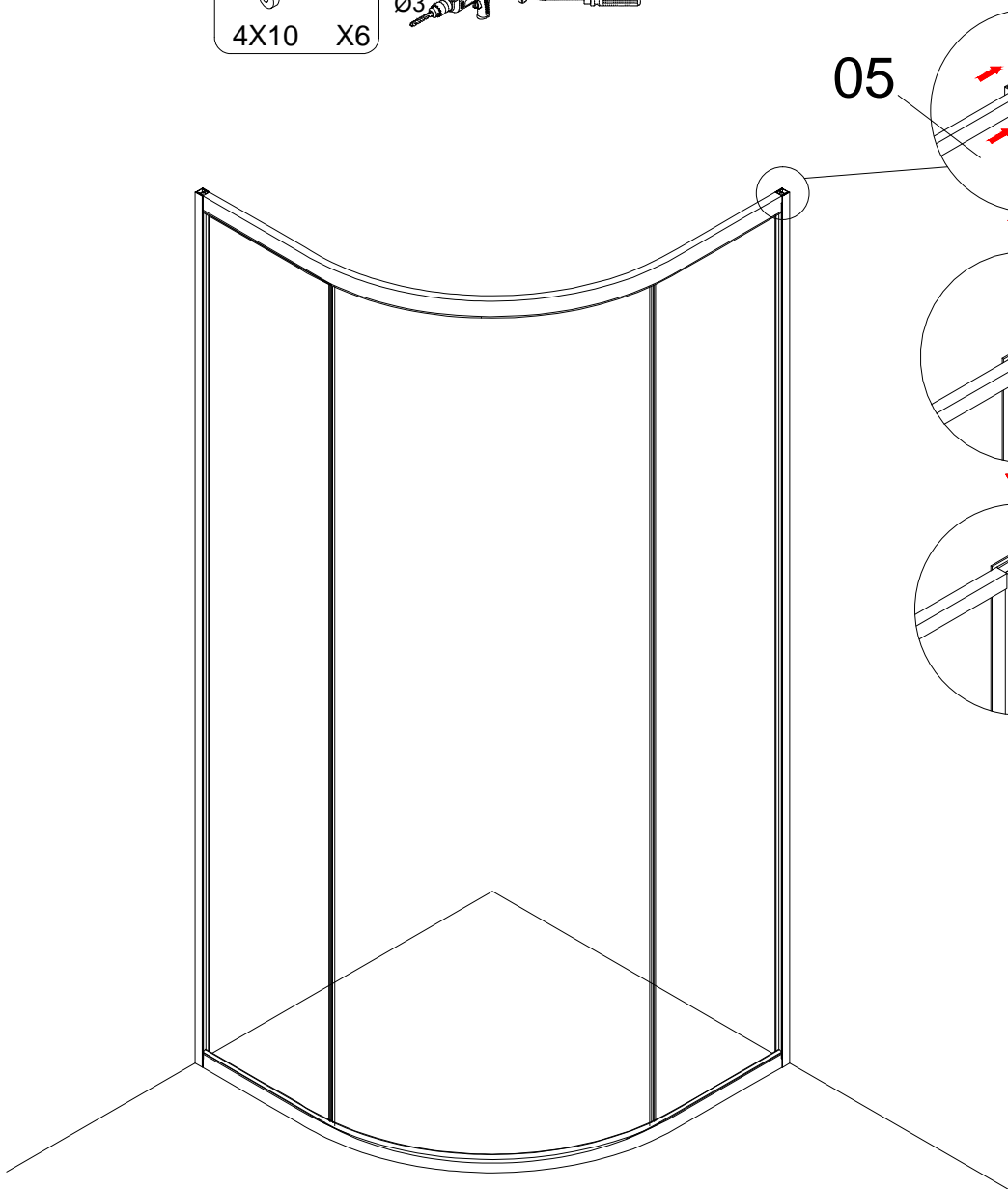
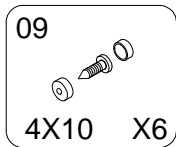

✓  $4\text{mm} \leq L \leq 16\text{mm}$   
✗  $L < 4\text{mm}, L > 16\text{mm}$

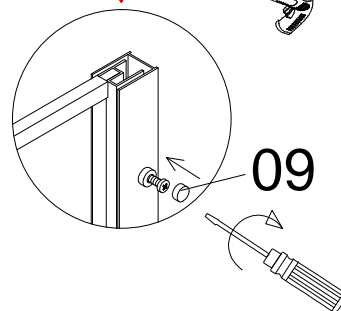
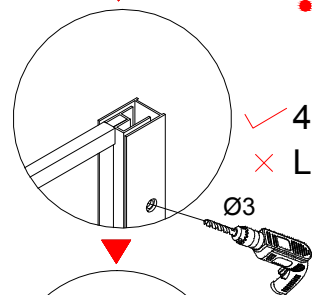

4

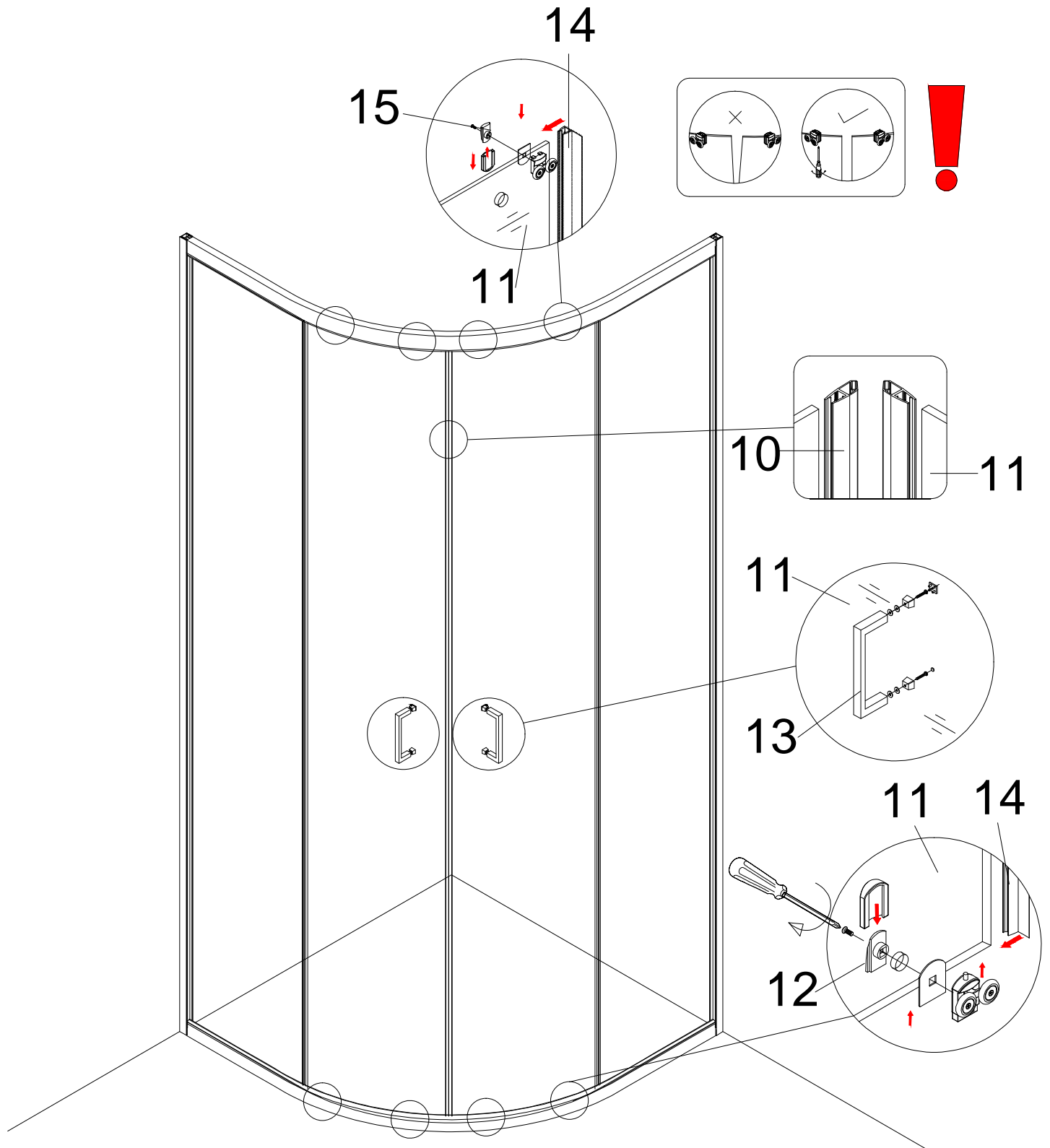
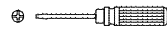
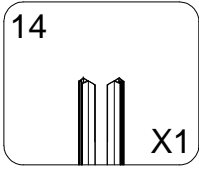
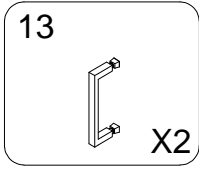
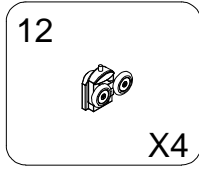
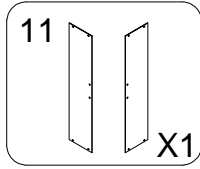
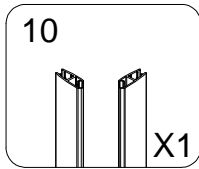



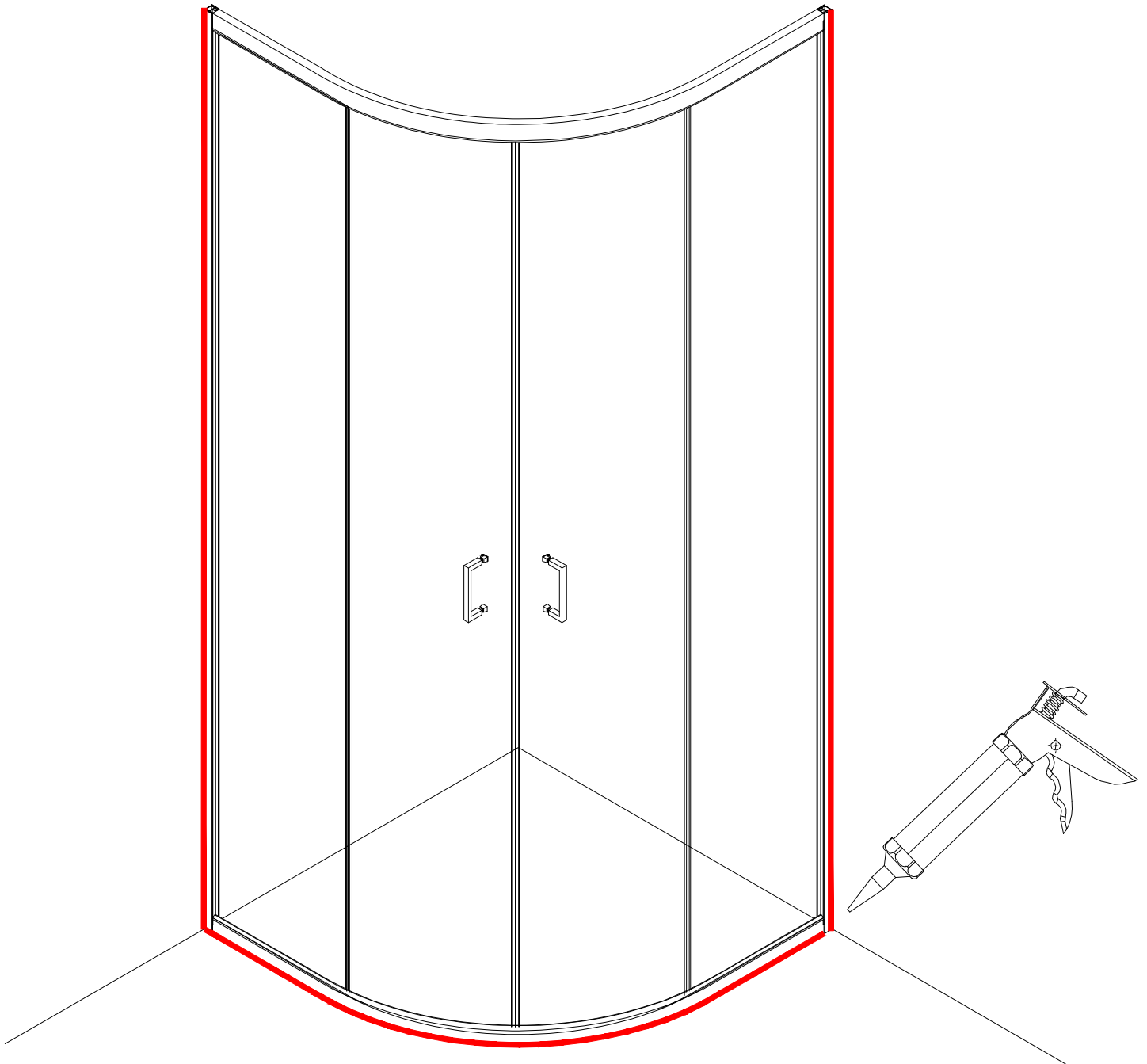
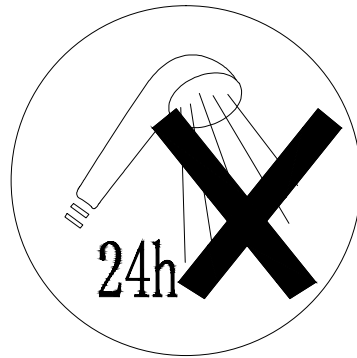
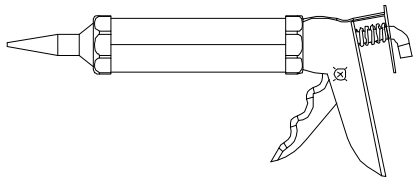

6