

BILLIE 77911 / 7850

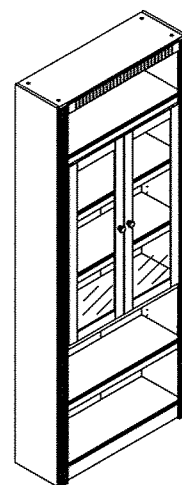

- | | |
|-----------------------------------------|-------------------------------------|
| (D) Montageanleitung | (GB) Assembly instructions |
| (FR) Notice de montage | (IT) Istruzioni di montaggio |
| (NL) Handleiding voor de montage | (PL) Instrukcja montażu |
| (CZ) Montážní návod | (SK) Návod na montáž |
| (HU) Szerelési útmutató | (RO) Instrucțiuni de montaj |
| (TR) Montaj talimatı | (RU) ИНСТРУКЦИЯ ПО МОНТАЖУ |

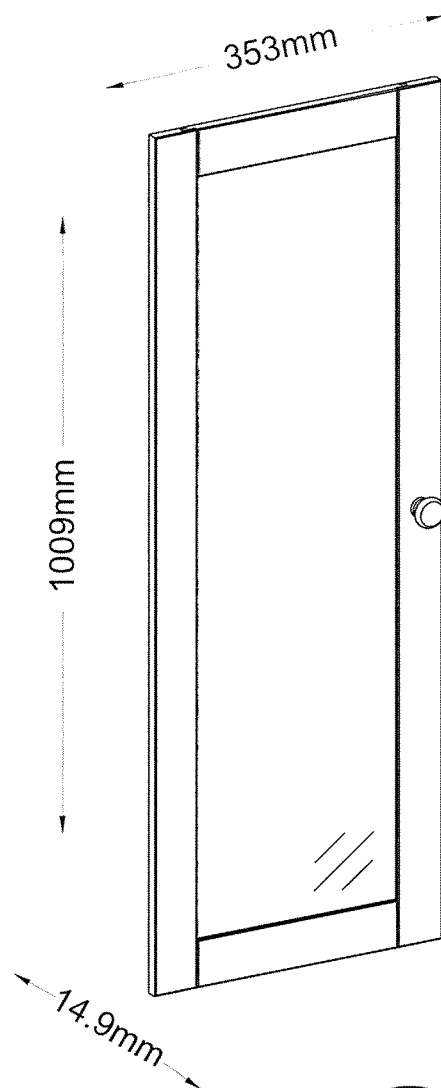
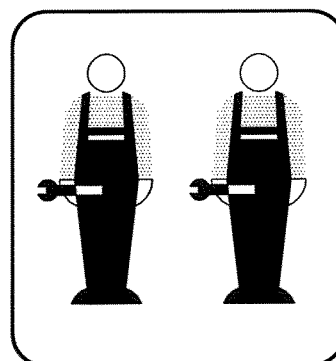
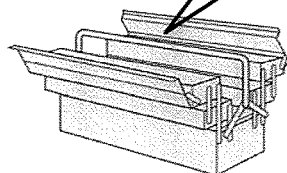
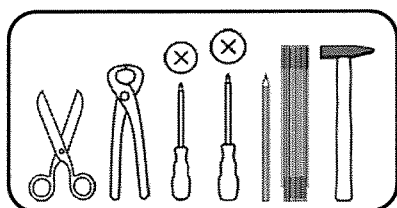

0
10
20
30
40
50
60
70
80
90
100
110
120
130
140
150
160
170
180
190
200

**Service • Assistenza • Dienstverlening • Serwis
Servis • Szerviz • Сервисная служба**

Name • Nom • Nome • Naam • Nazwa • Jméno • Názov • Név • Denumire • Isim • Название	
Nr. • No. • N° • Номер • Č • Sz	
Typ • Type • Tip • Típus • Tipo • Тип	

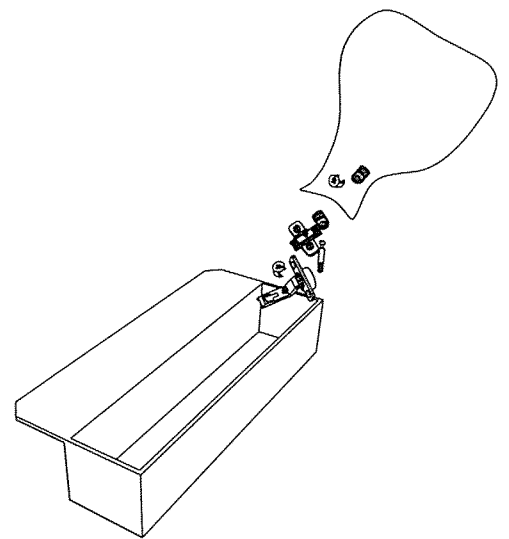
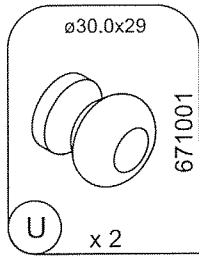
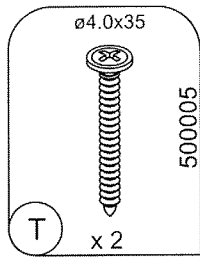
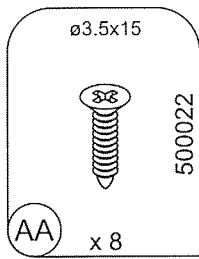
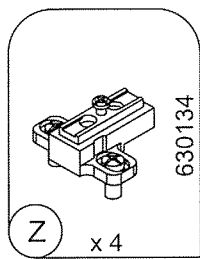
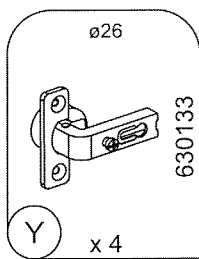
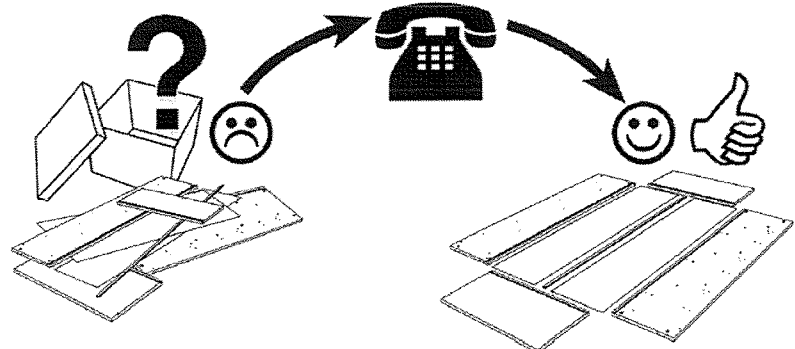
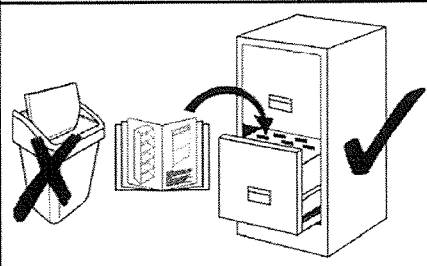

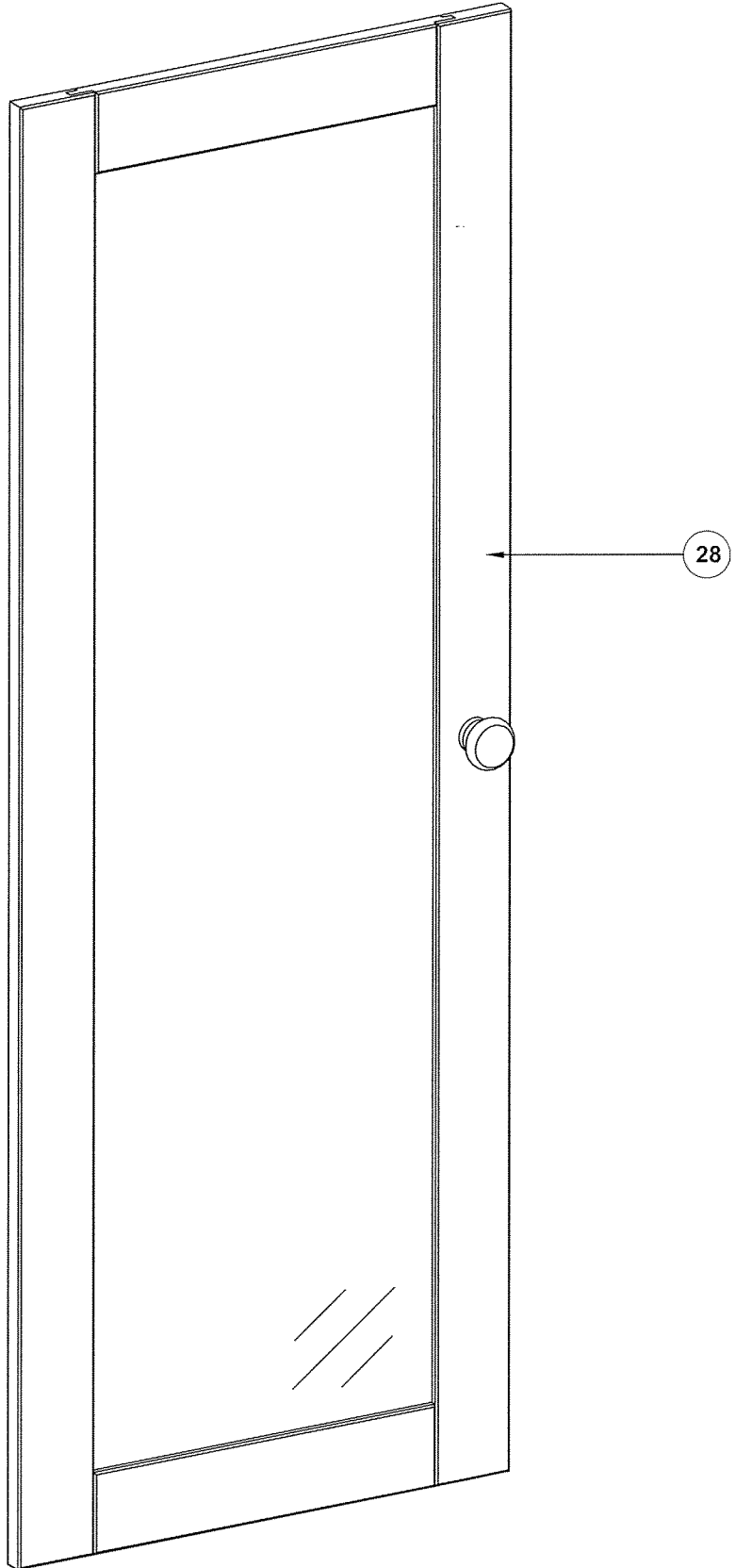

01

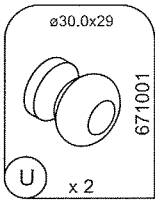
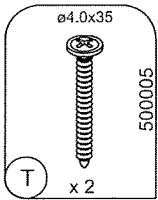
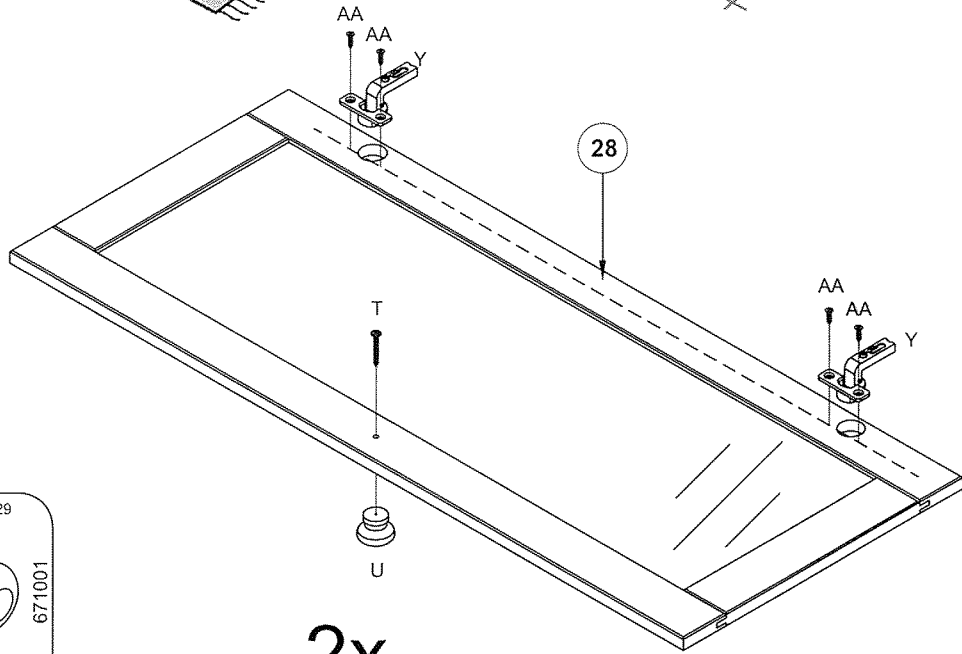
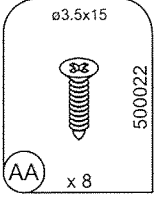
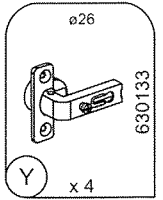
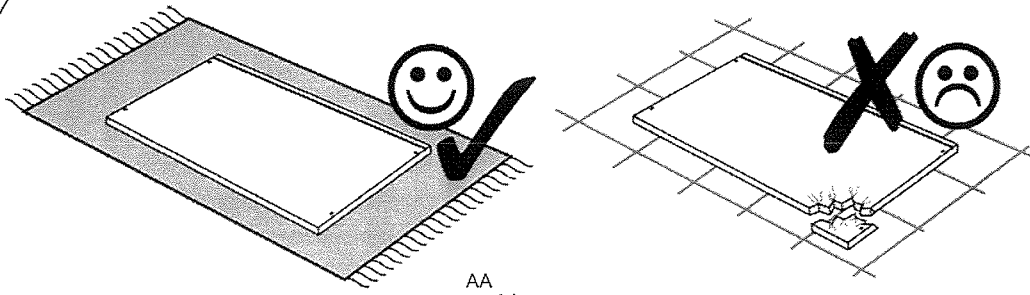

2x

02

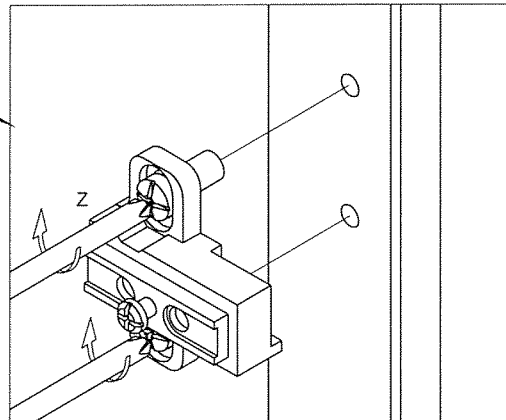
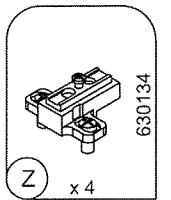
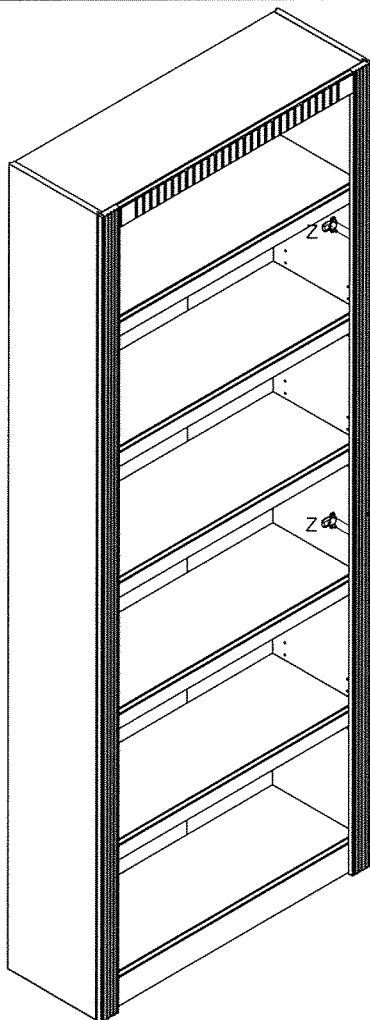

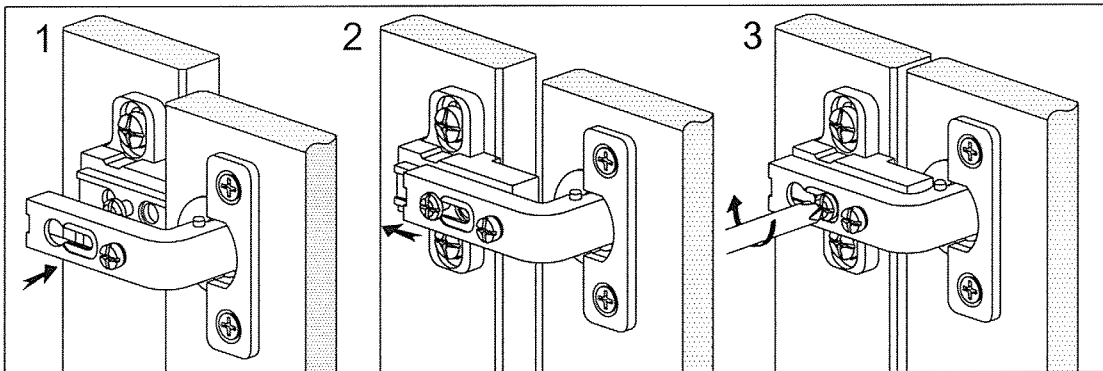
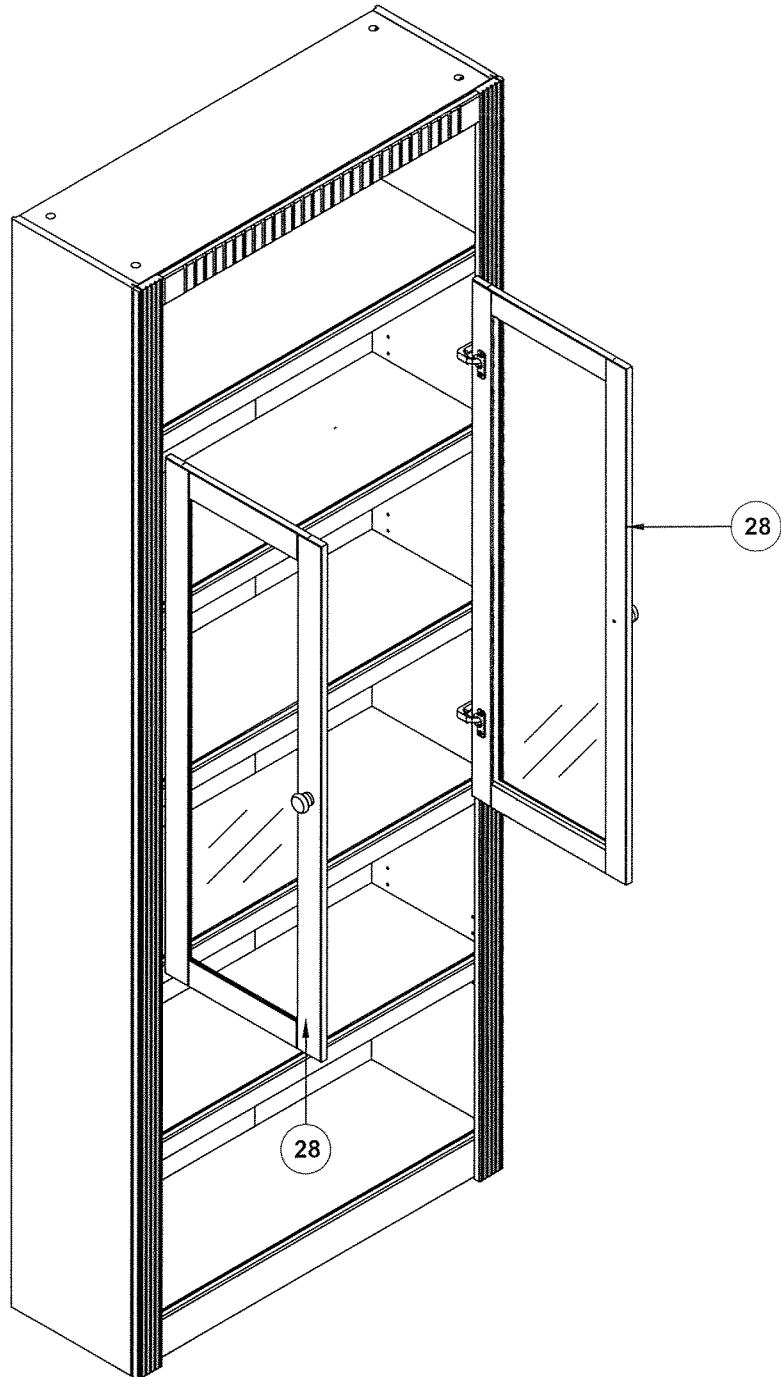

04

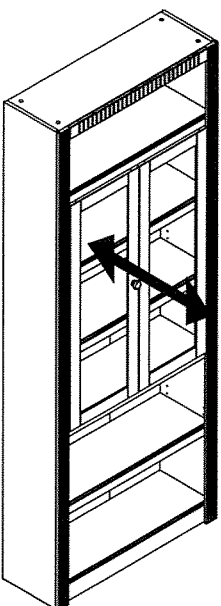
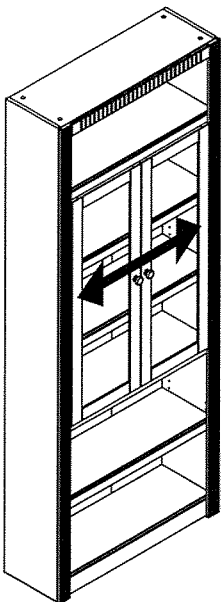
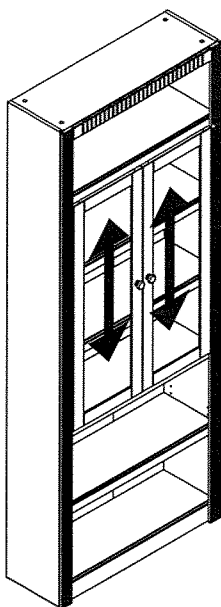

Türen einstellen (Scharniere justieren)
Adjusting the doors (adjusting the hinges)

Régler les portes (ajuster les charnières)

Sistemare le porte (regolare le cerniere)

Deuren instellen (scharnieren afstellen)

Nastawić drzwi (wyregulować zawiasy)

Vyrovnejte dvířka (seřid'te závěsy)

Nastavenie dverí (nastavenie závesov)

Állítsa be az ajtókat (állítsa be a zsanérokat)

Reglare uși (ajustare balamale)

Kapıların ayarlanması (menteşelerin seviye ayarı)

Регулировка Дверей (регулировка шарнира)

