

A X...

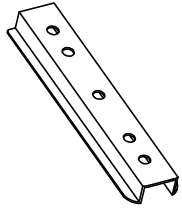

B X...

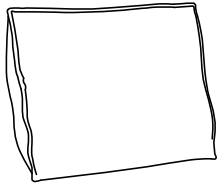

3 X...

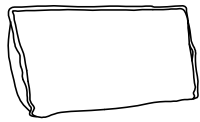

4 X...

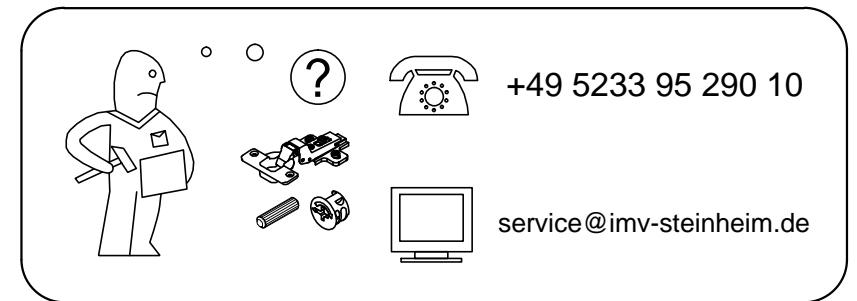
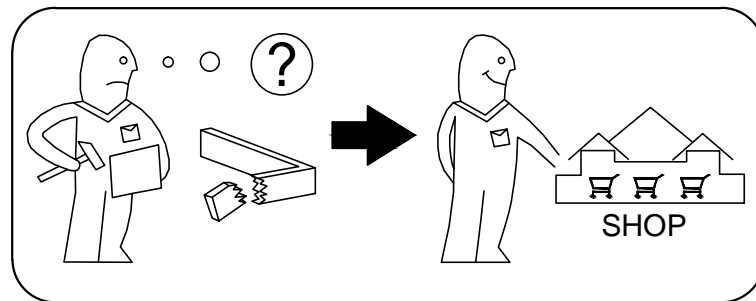
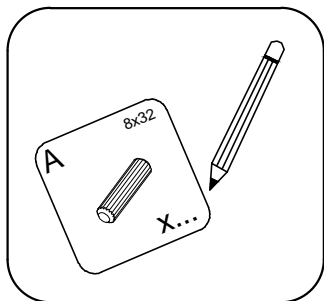
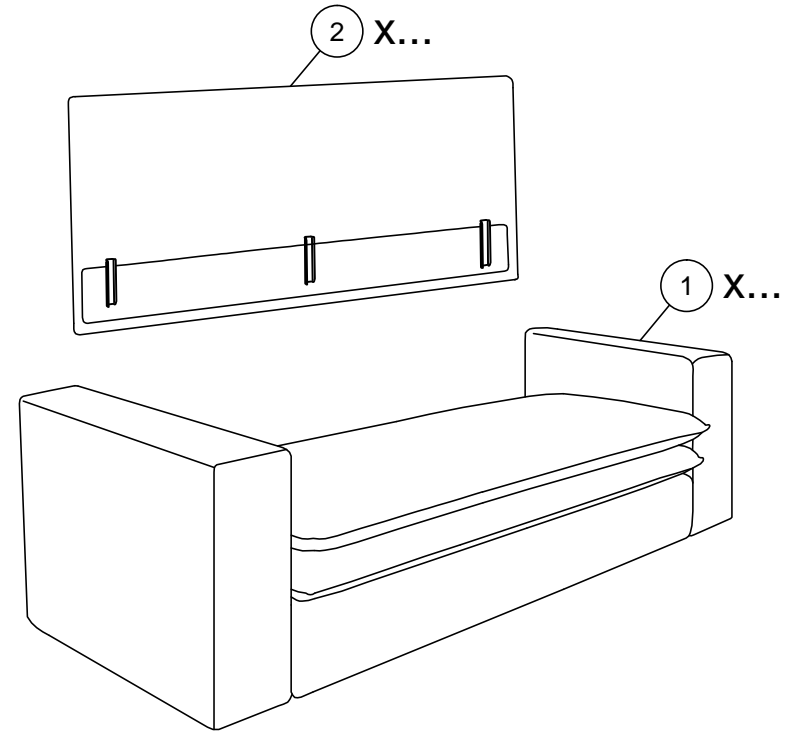

KARTA SERWISOWA / SERVICE FORM / SERVICEKARTE

