

530 azb

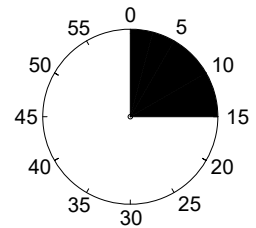
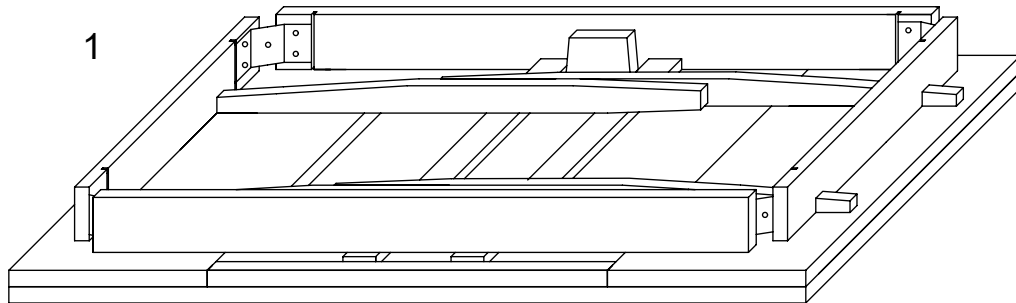
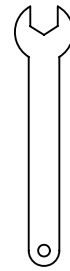
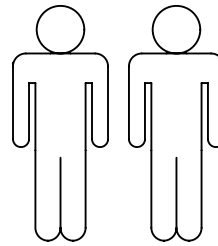
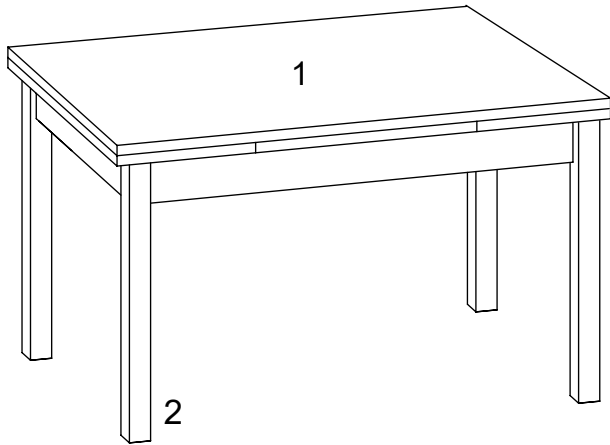

1	1x
2	4x

A	4x	B	4x				

1.

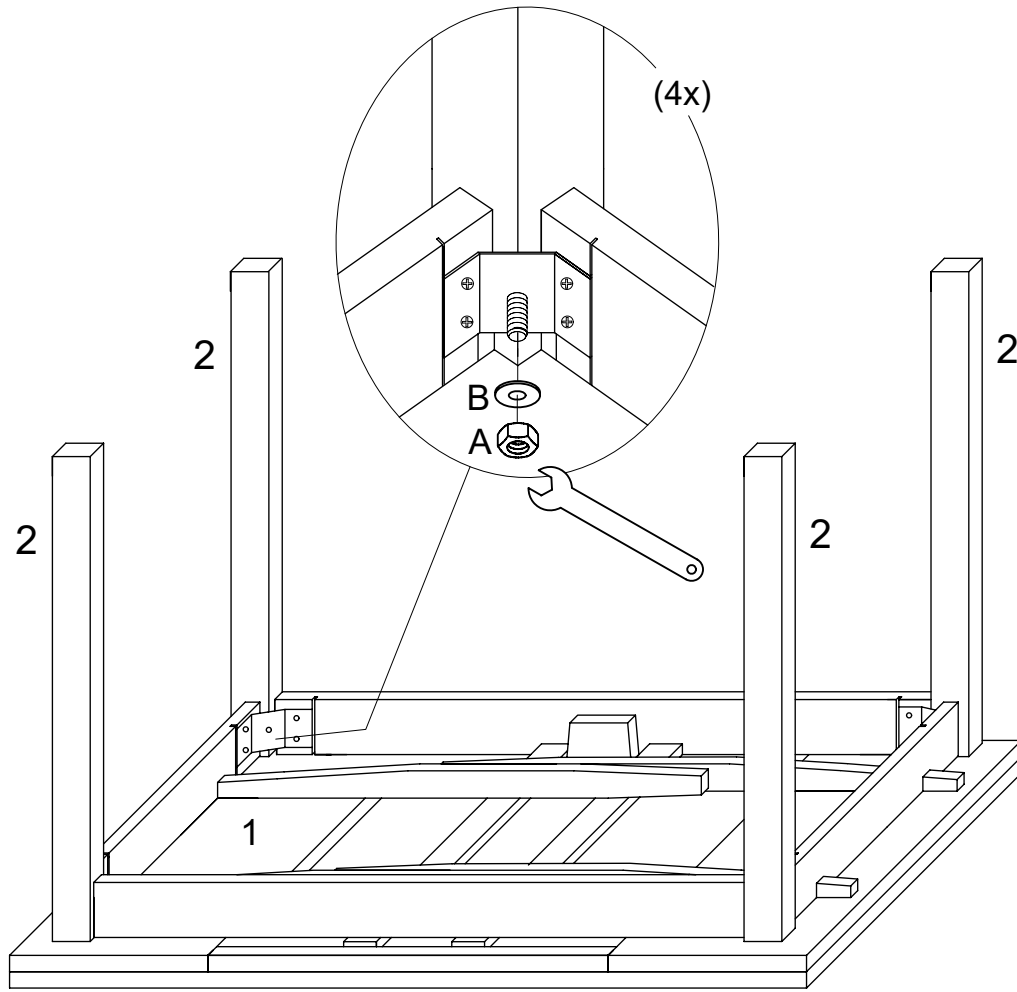

2.

