

Venus

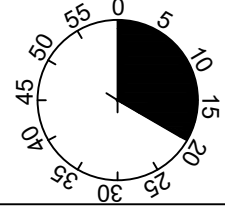

1

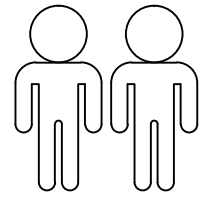
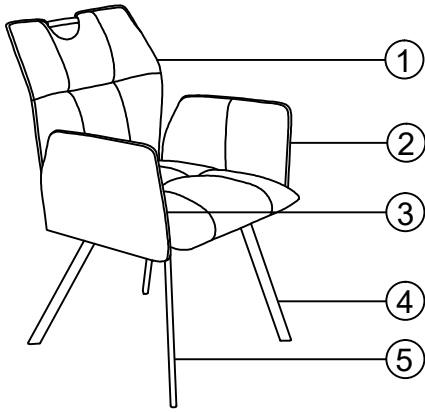
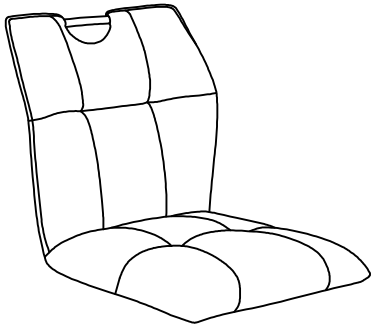

2

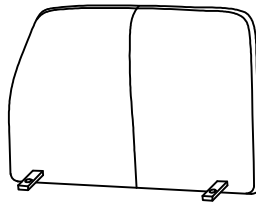

R

3

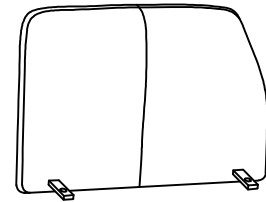

L

4

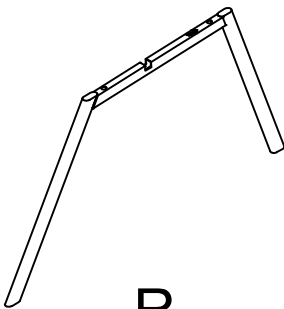

R

5

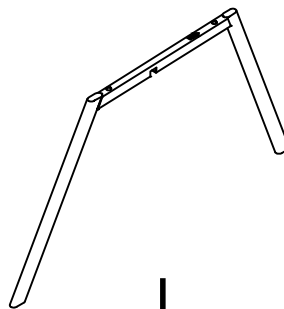

L

| | |
|---|----|
| 1 | 1x |
| 2 | 1x |
| 3 | 1x |
| 4 | 1x |
| 5 | 1x |

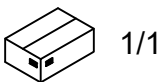

1/1

A

M6X13



4x

B

M6X25

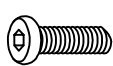

4x

C

M6X40

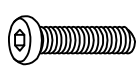

4x

D

M6



4x

E

Ø14xØ6x1.5



8x

F

4MM

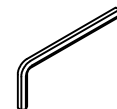

1x

G

T2.0x90x90

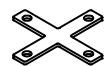



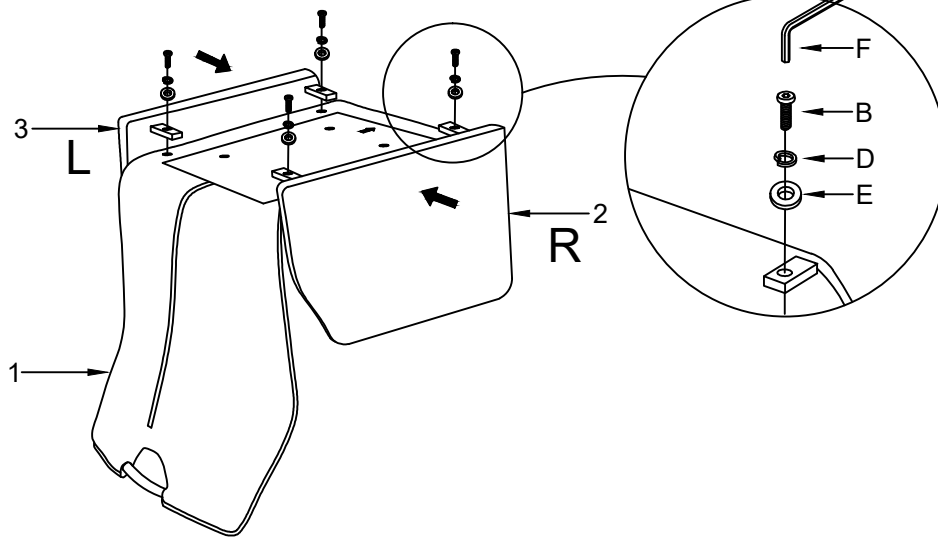

1x

I.



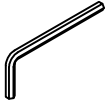

1

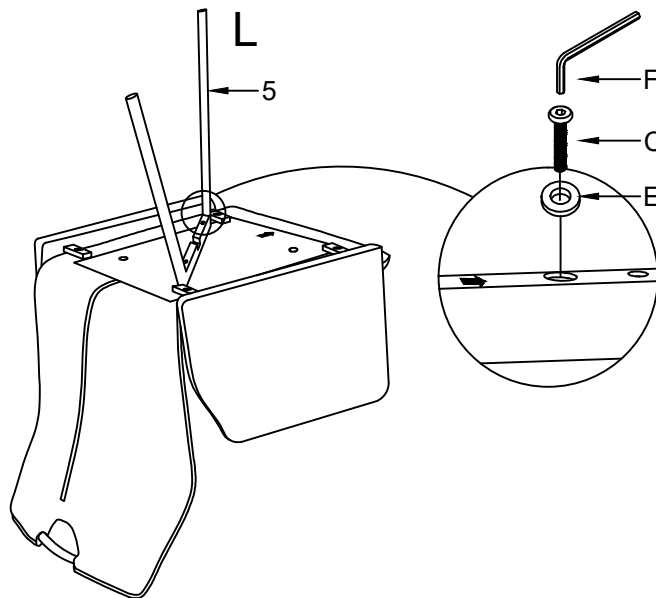

| | | | |
|---|------------|---|----|
| B | M6x25 |  | 4x |
| D | M6 |  | 4x |
| E | Ø14xØ6x1.5 |  | 4x |
| F | 4MM |  | 1x |
|  | | | |

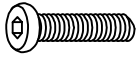

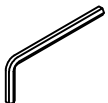

2

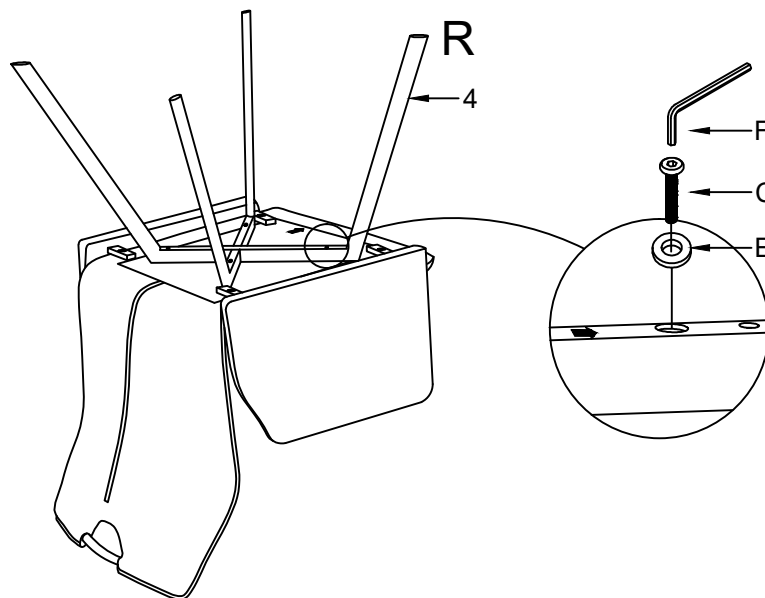

| | | | |
|---|------------|---|----|
| C | M6x40 |  | 2x |
| E | Ø14xØ6x1.5 |  | 2x |
| F | 4MM |  | 1x |
|  | | | |

3





| | | | |
|---|------------|---|----|
| C | M6x40 |  | 2x |
| E | Ø14xØ6x1.5 |  | 2x |
| F | 4MM |  | 1x |
|  | | | |

II.

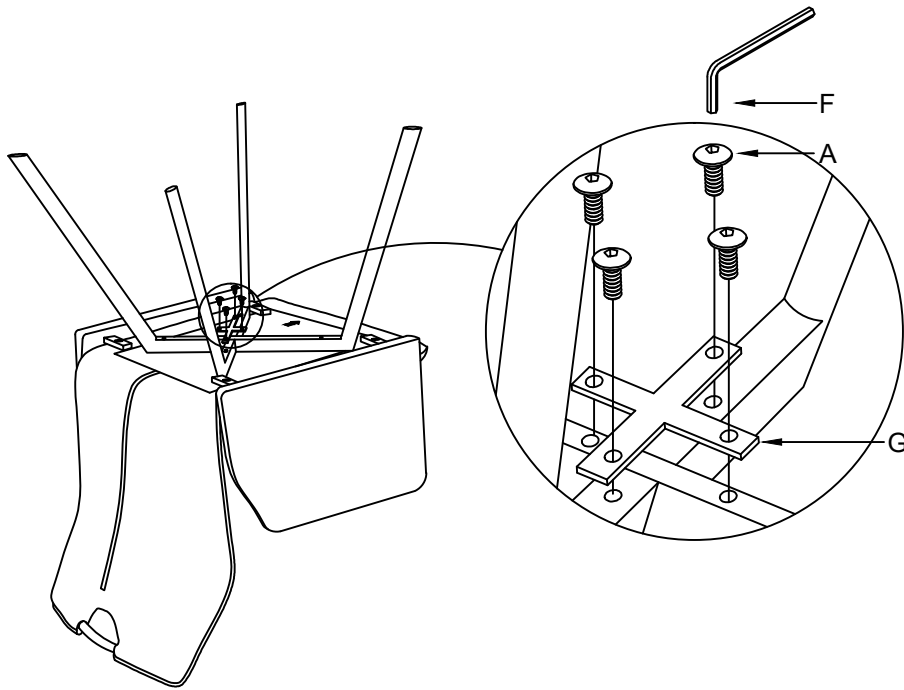

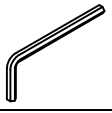
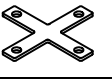
4

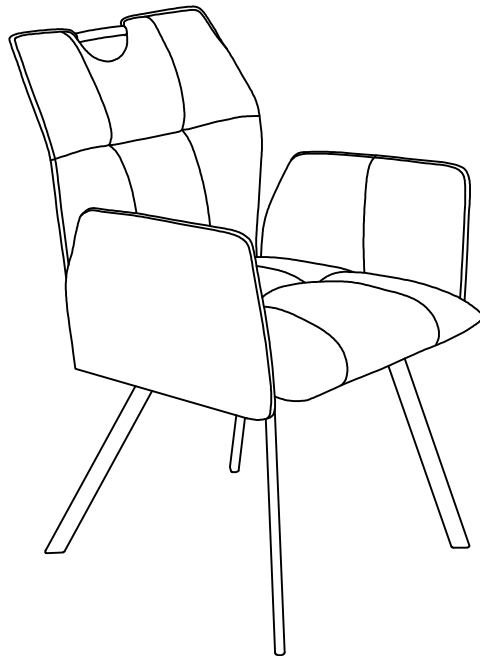

| | |
|---|------------|
| A | M6x13 |
|  | 4x |
| F | 4MM |
|  | 1x |
| G | T2.0x90x90 |
|  | 1x |
|  | |

5

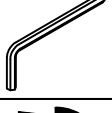

| | |
|---|-----|
| F | 4MM |
|  | 1x |
|  | |



LE TRI
+ FACILE



+



Séparez les éléments avant de trier