

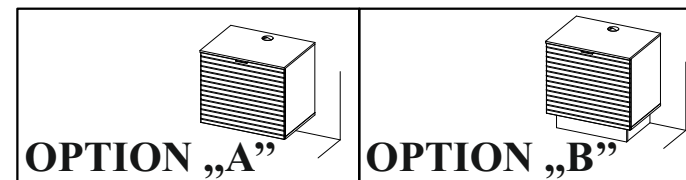

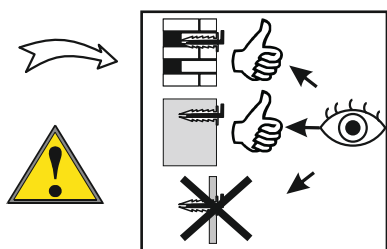

info@bega-consult.de

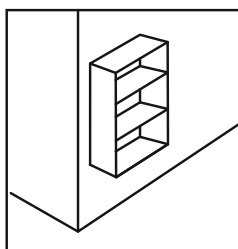

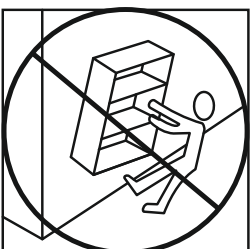
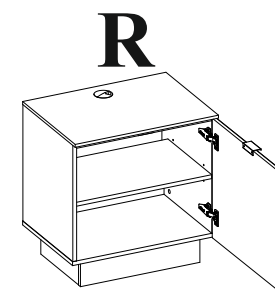
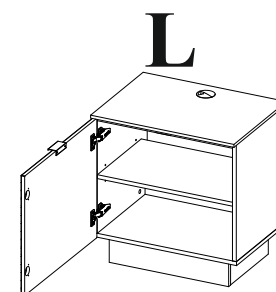
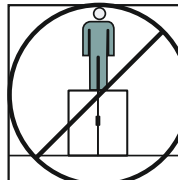
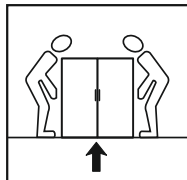
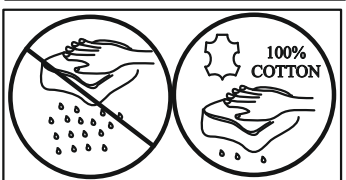
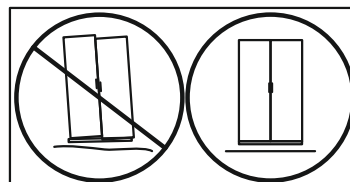
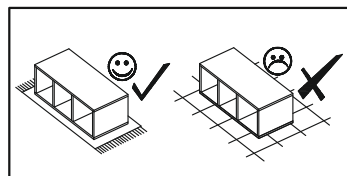
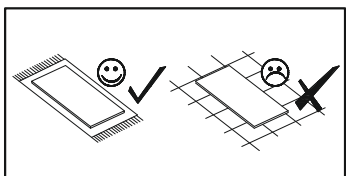
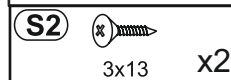
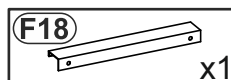
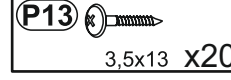
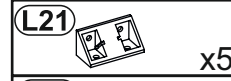
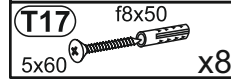
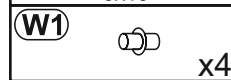
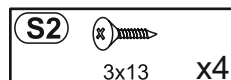
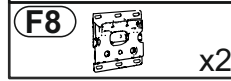
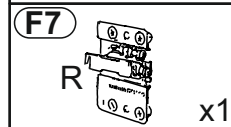
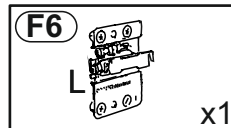
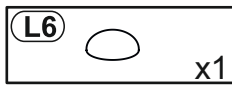
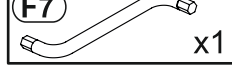
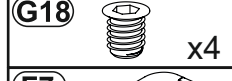
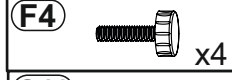
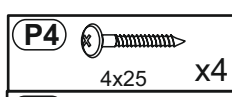
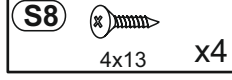
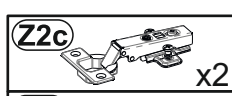
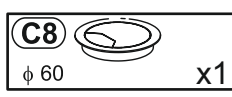
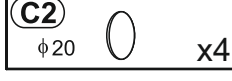
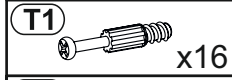
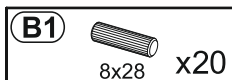

Nr				pcs	
1	477	418	16	1	1
2	477	418	16	1	1
3	566	399	16	1	1
4	600	418	16	1	1
5	566	367	16	1	1
6	600	440	12	1	1
7	500	110	16	1	1
8	326	110	16	1	1
9	326	110	16	1	1
10	466	110	16	1	1
11	566	80	16	2	1
12	596	488	16	1	1

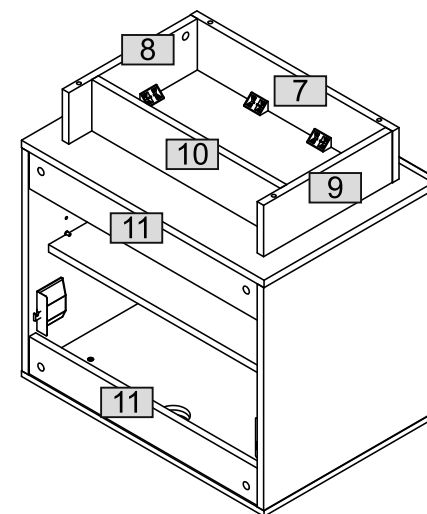
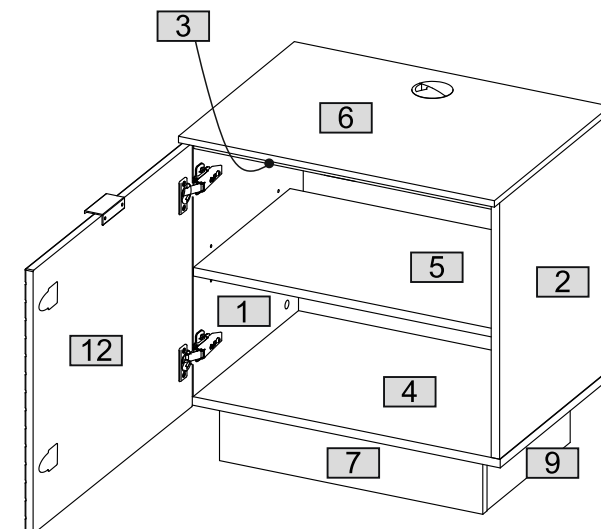

0 10 20 30 40 50 60 70 80 90 100 110 120 130 140 150 160 170 180 190 200



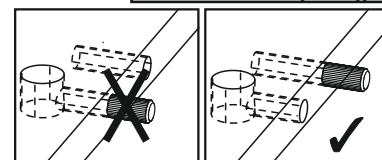
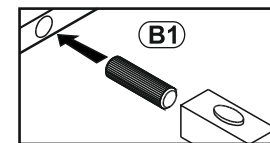
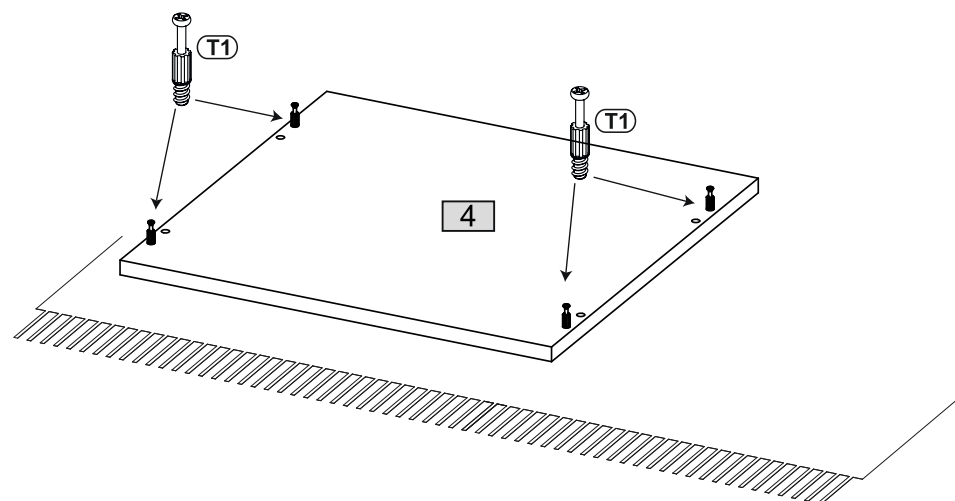
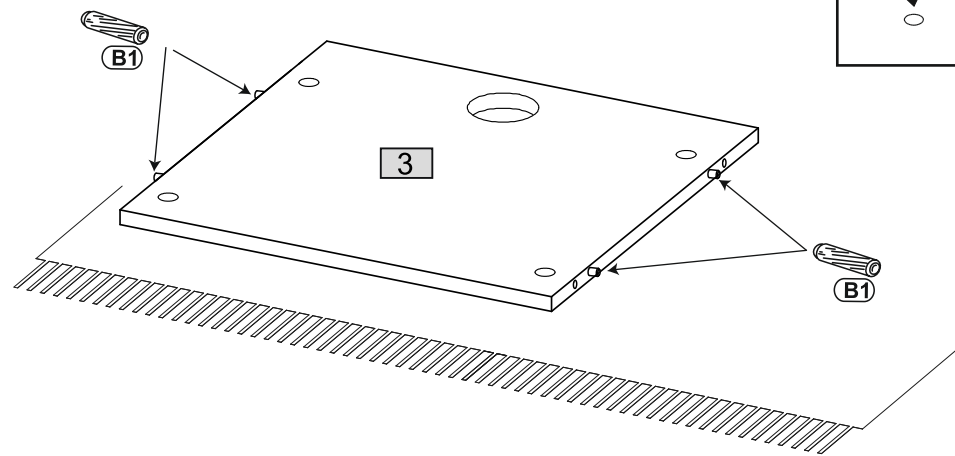
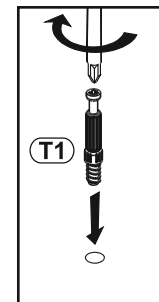
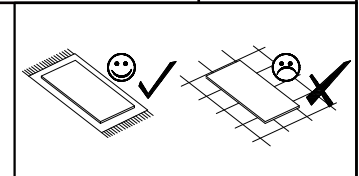
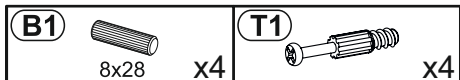

1

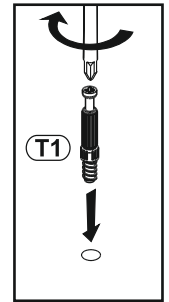
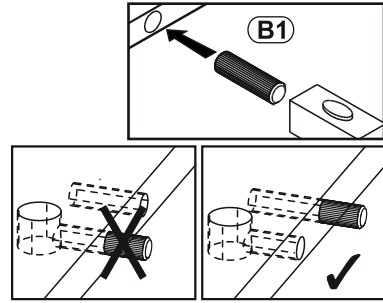
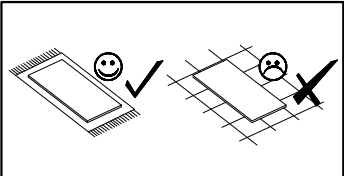
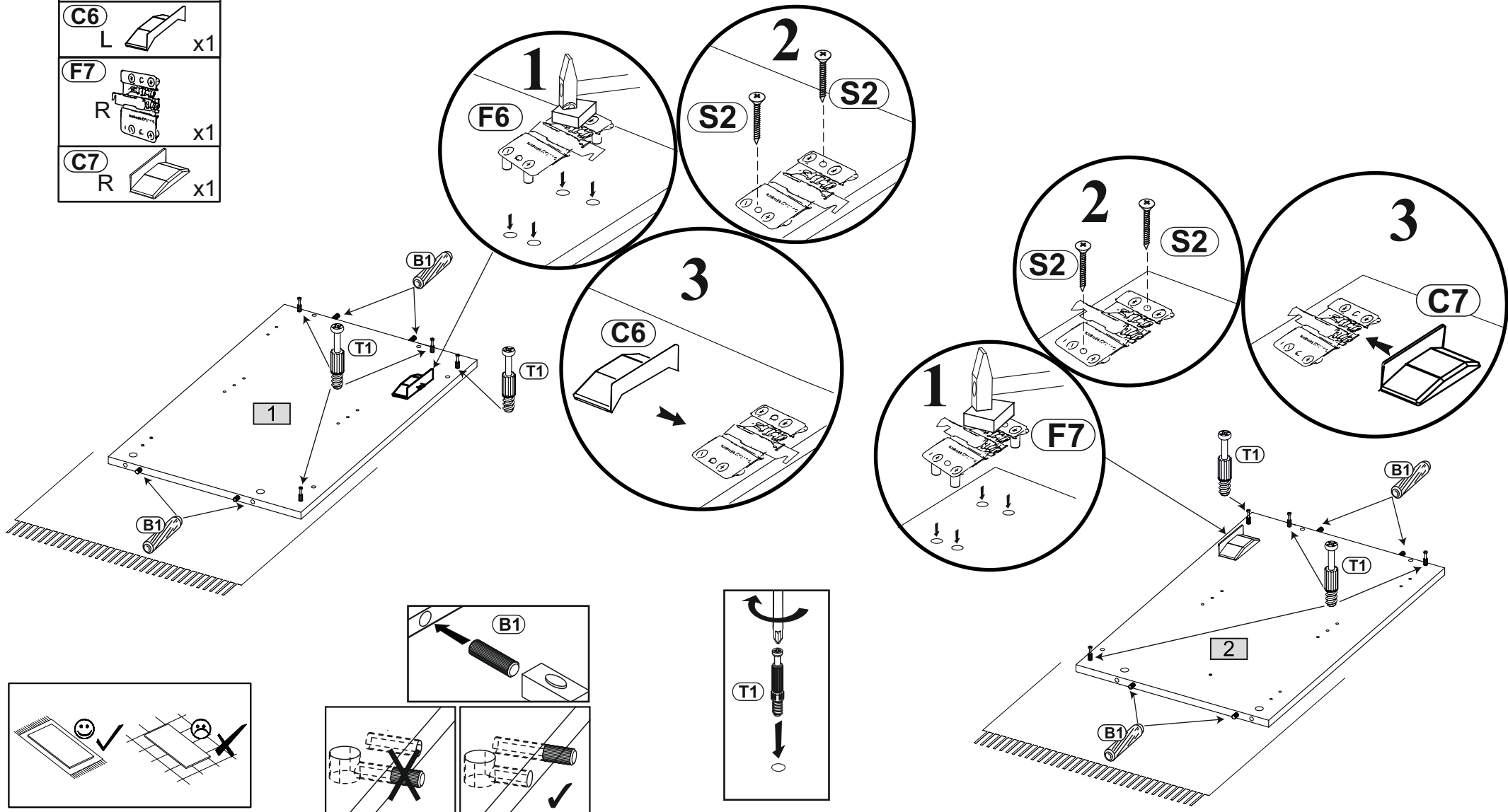
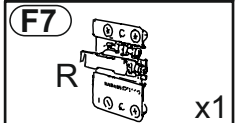
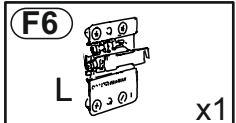
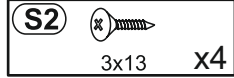
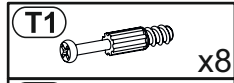
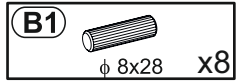

2



3

- Z2c**  x2
- S8**  4x13 x4
- C13**  $\phi 35$ x2

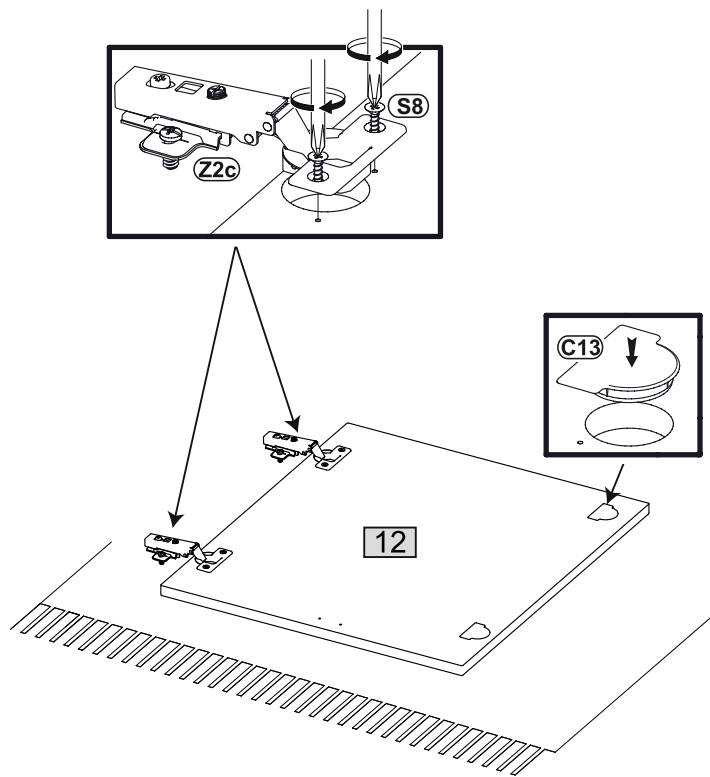

4

- B1**  8x28 x4

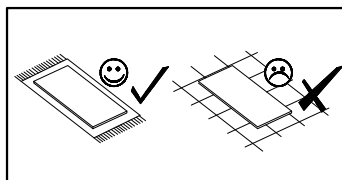
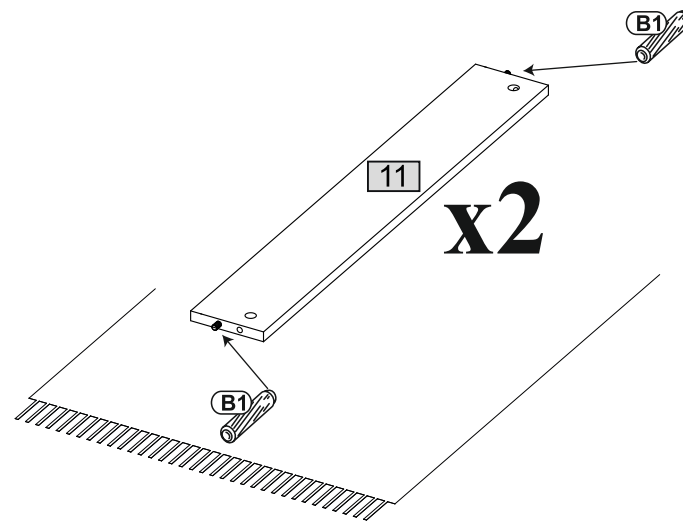

5

M1
φ15x12 x8

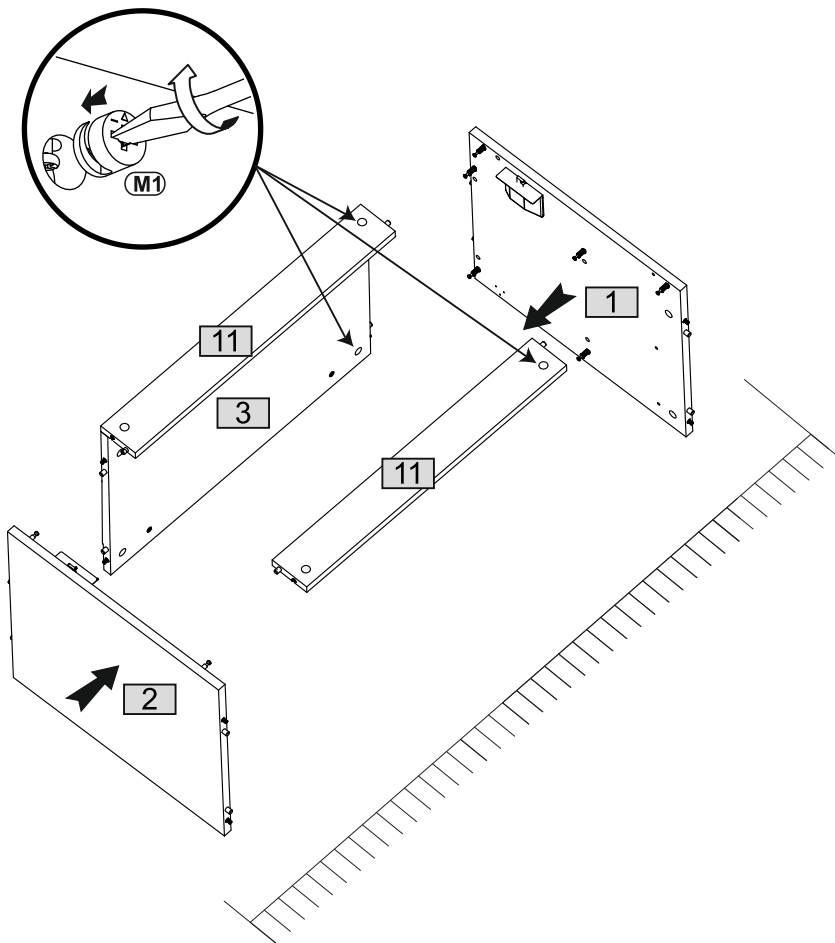

6

M1
φ15x12 x4

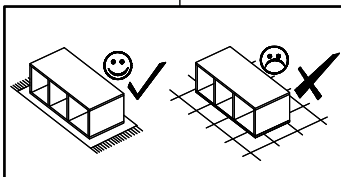
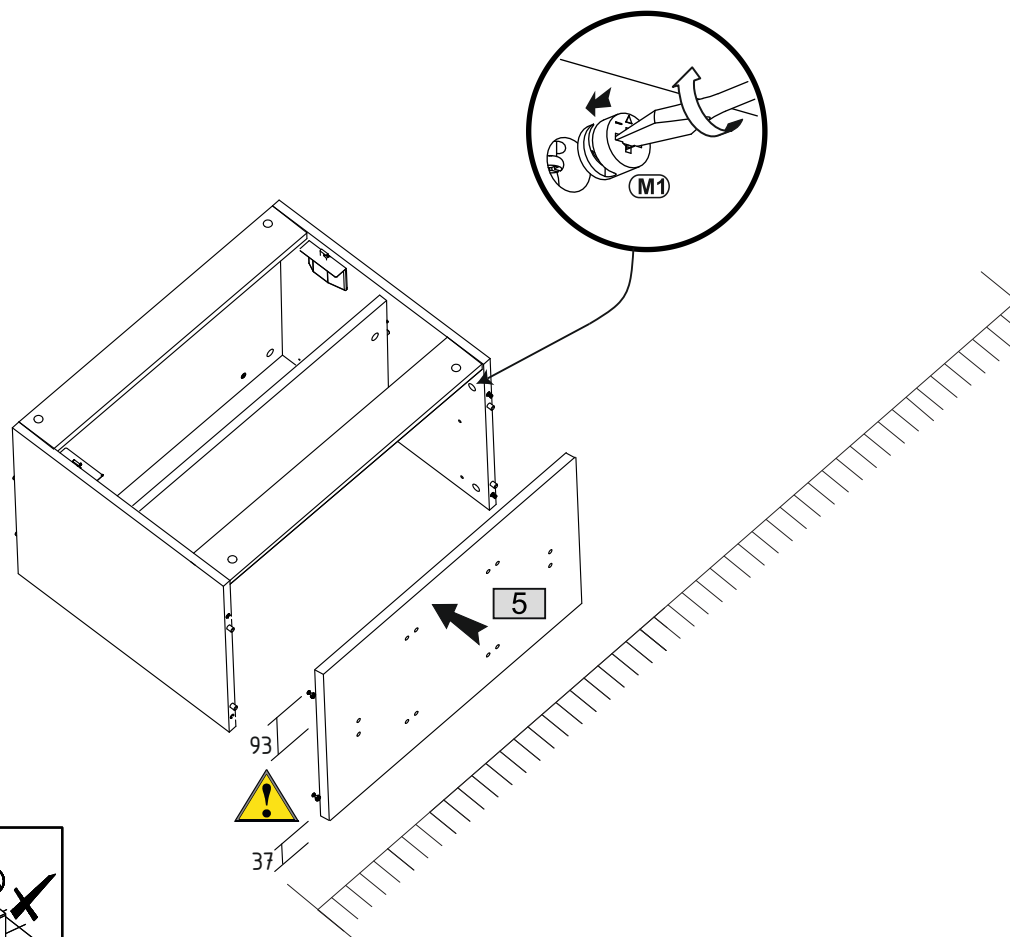

7 **P4**  4x25 x4

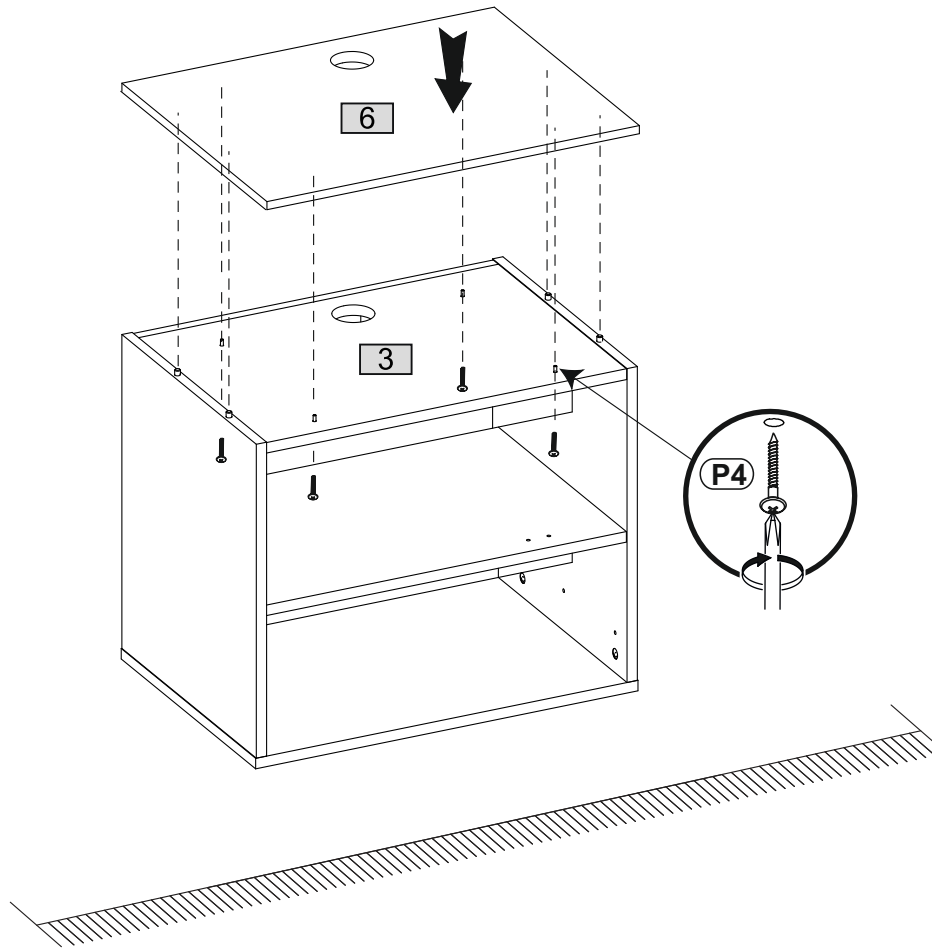

OPTION „A”

1-9

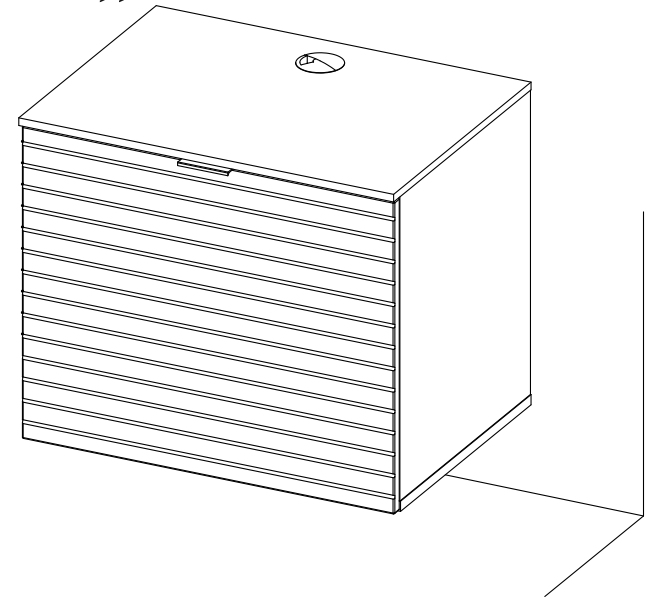

OPTION „B”

10-14

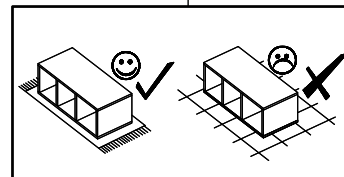
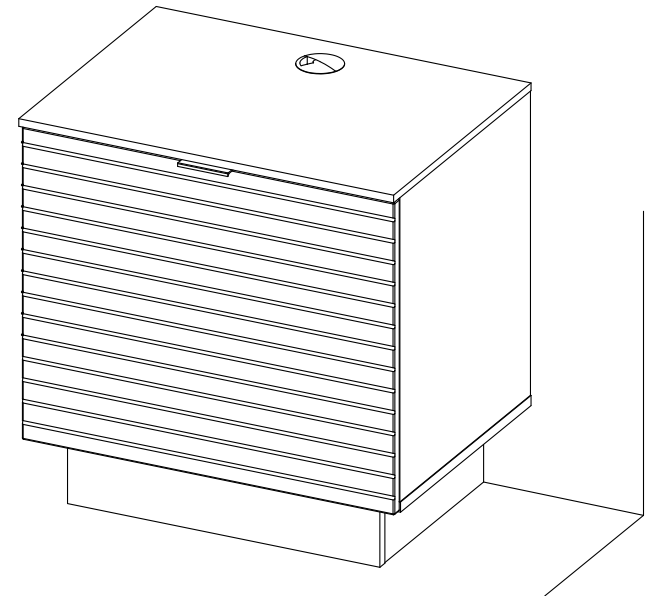

8

T17	φ8x50
5x60	x8
F8	x2

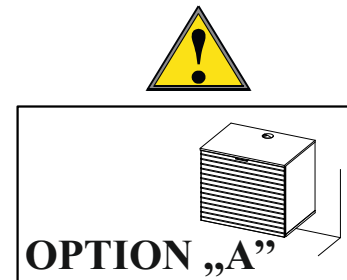
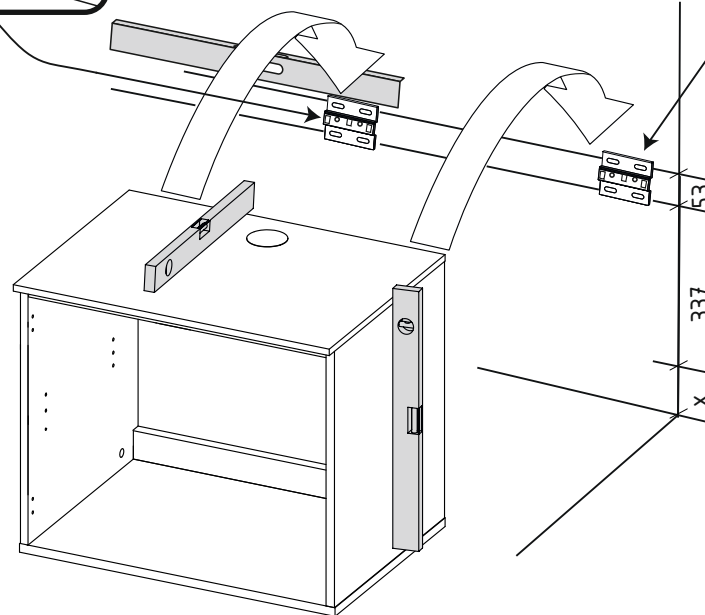
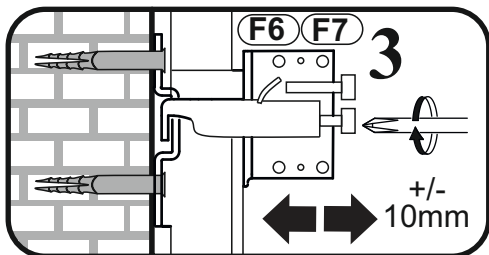
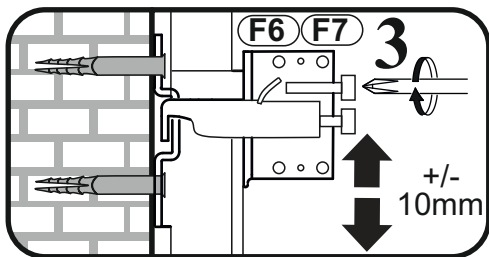
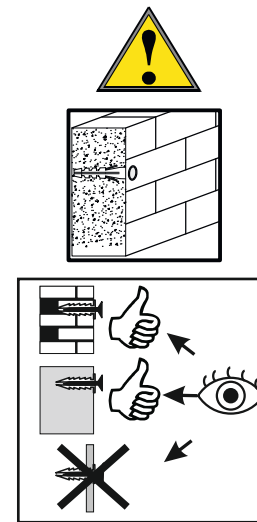
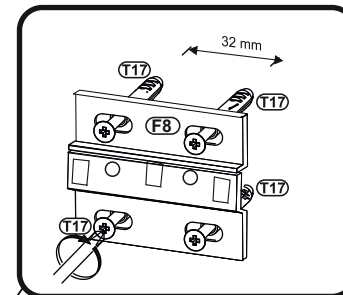
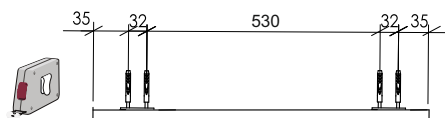
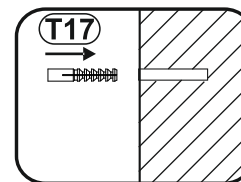
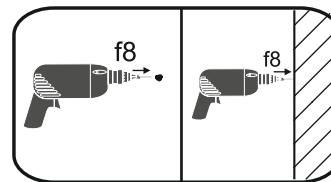
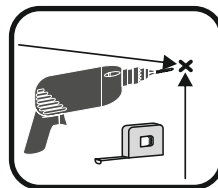
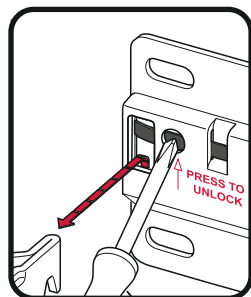
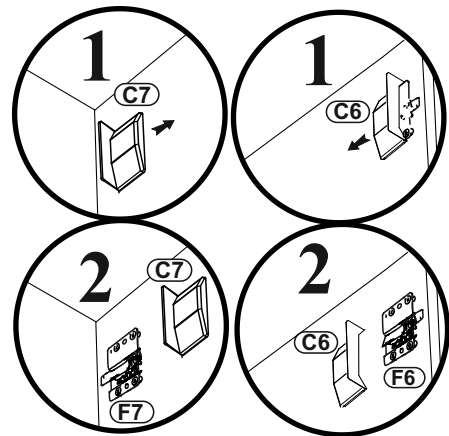

9

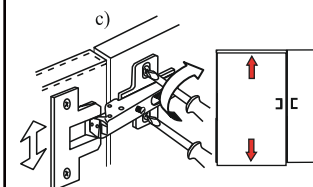
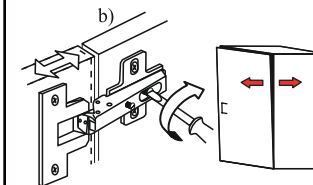
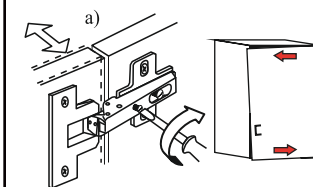
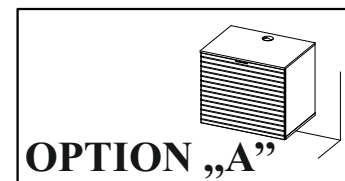
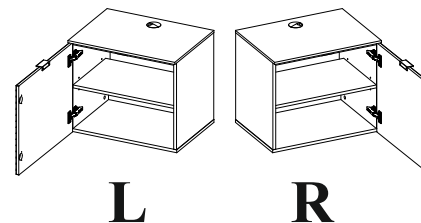
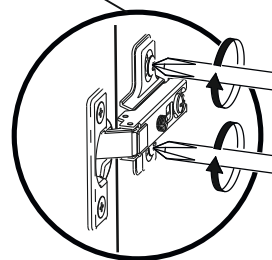
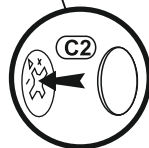
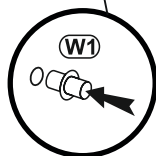
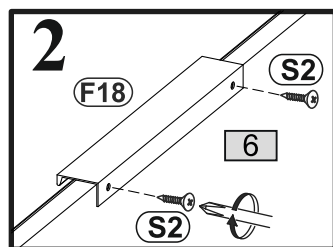
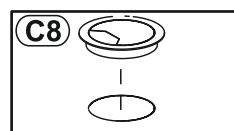
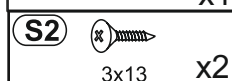
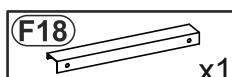
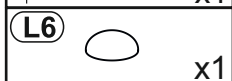
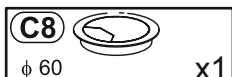
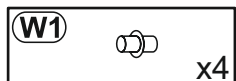
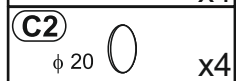
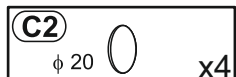

10

L21		x5
P13		3,5x13 x10

F4		x4
G18		x4
F7		x1

T1		x4
-----------	--	----

B1		φ 8x28 x4
-----------	--	-----------

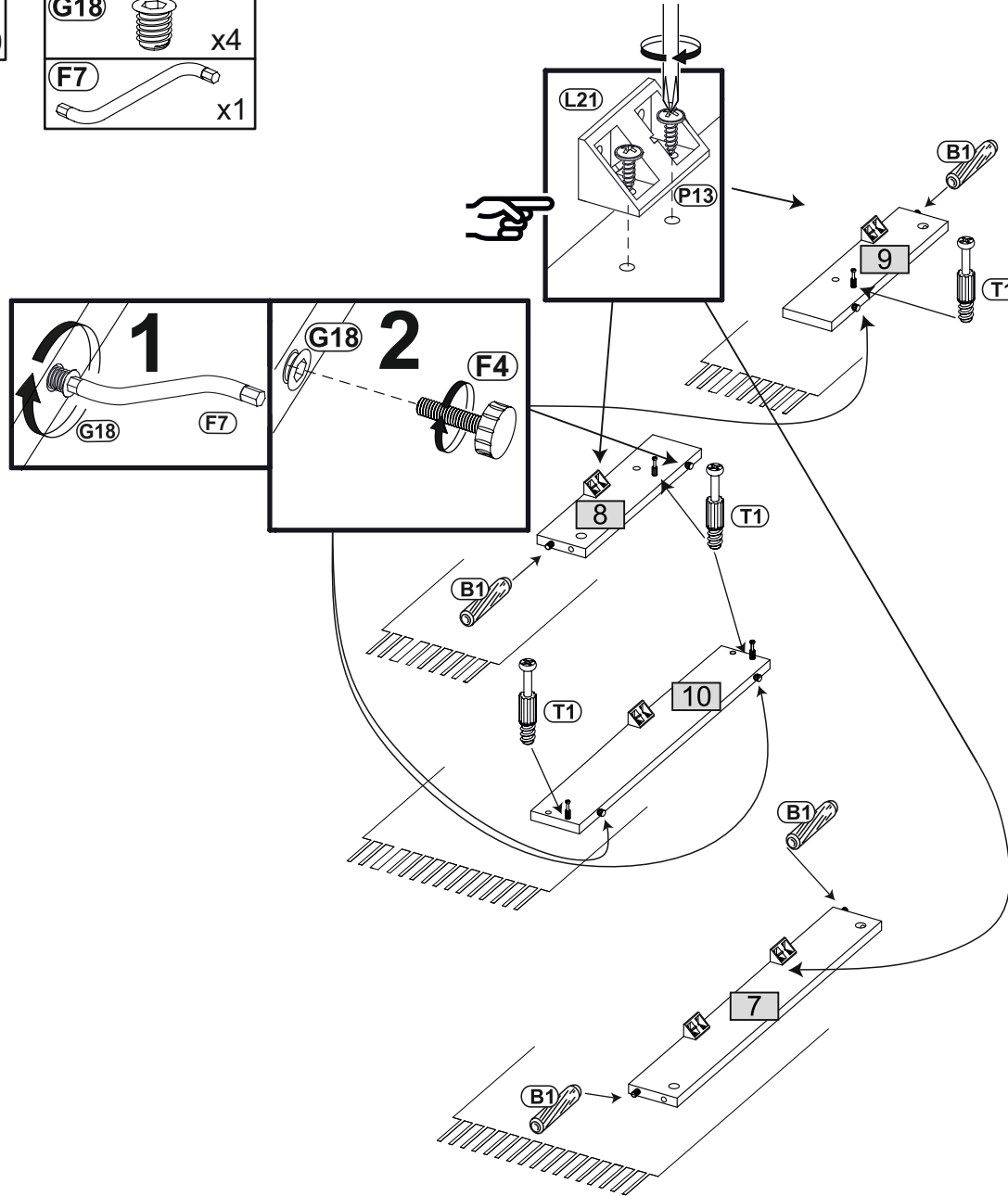
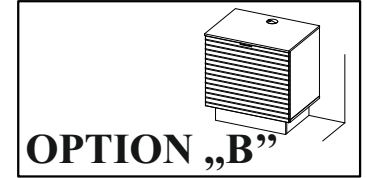

11 **M1**  $\phi 15 \times 12$ x2

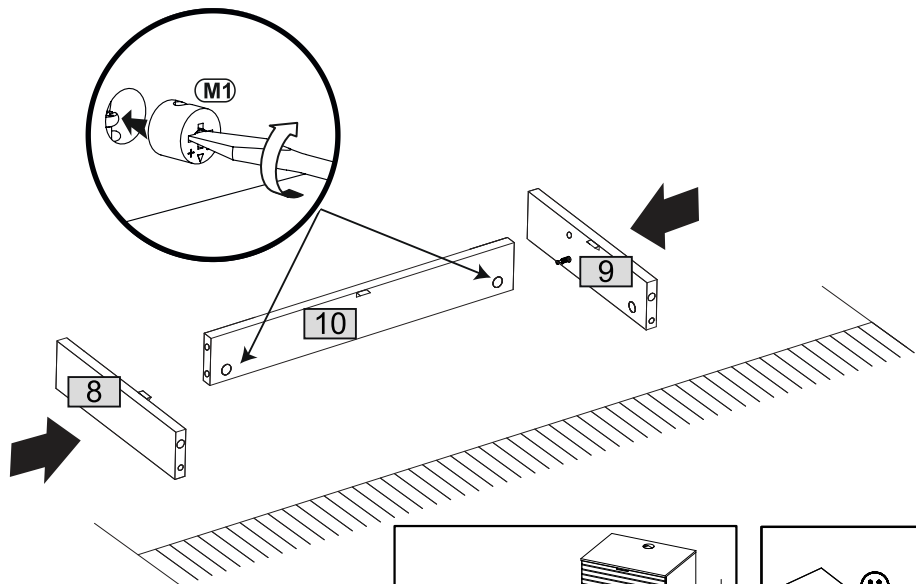

13 **P13**  3,5x13 x10

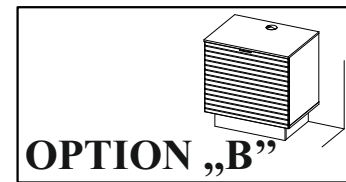

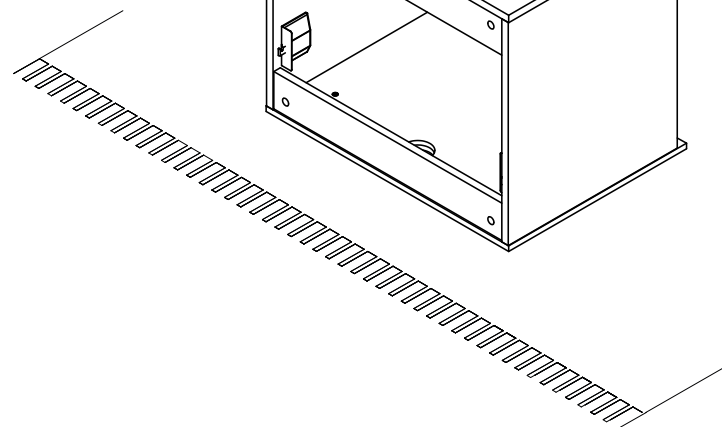
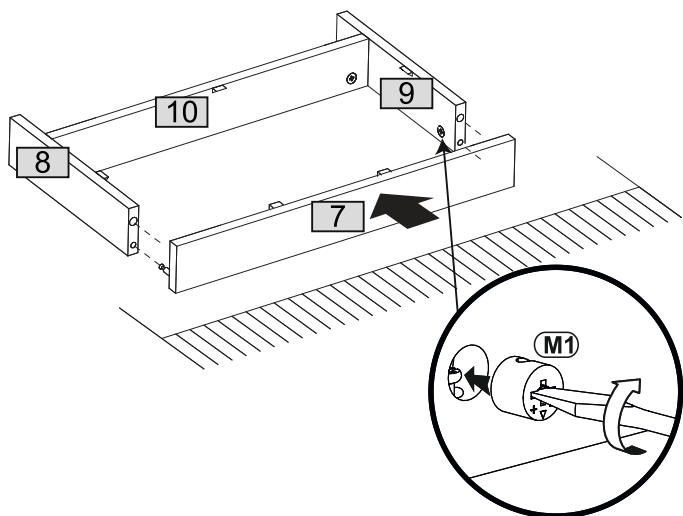
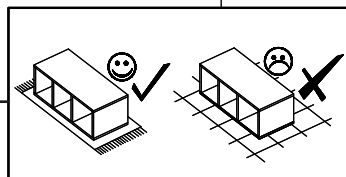

12 **M1**  $\phi 15 \times 12$ x2

OPTION „B”



14

T17	φ8x50	
5x60		x8
F8		x2

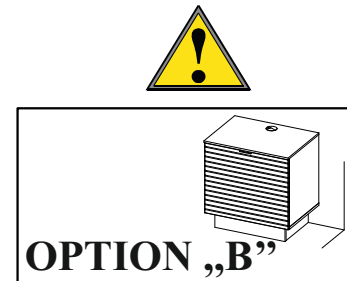
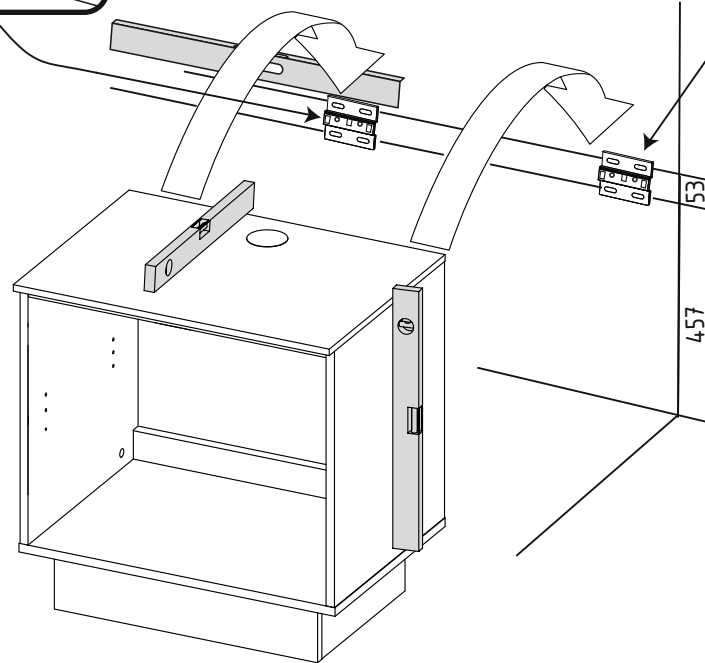
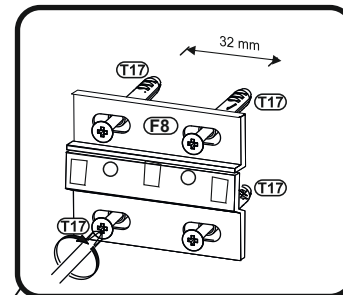
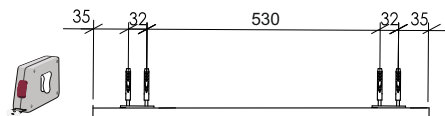
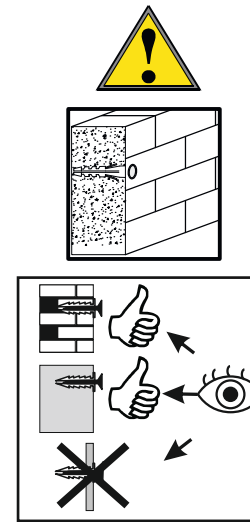
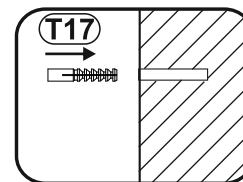
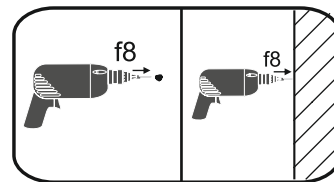
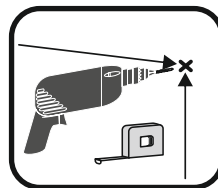
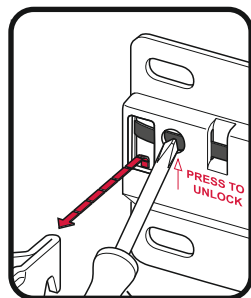
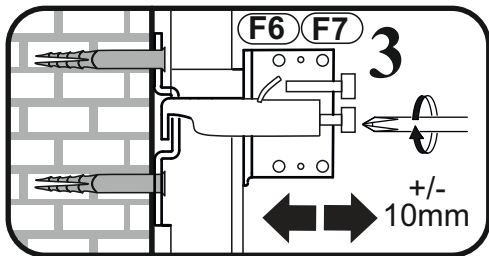
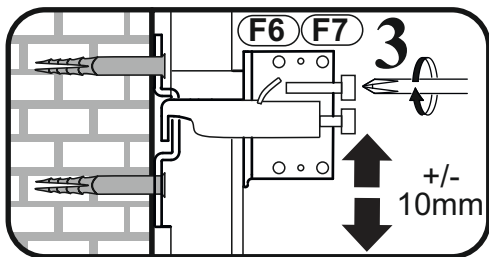
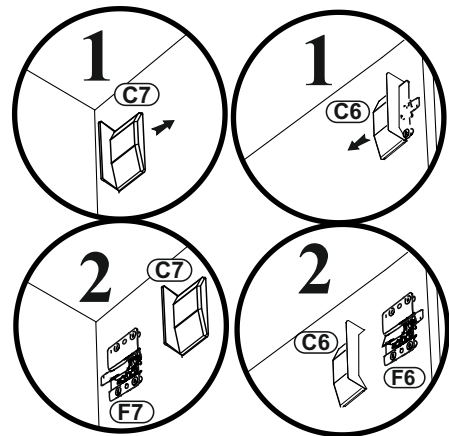

15

