

980758

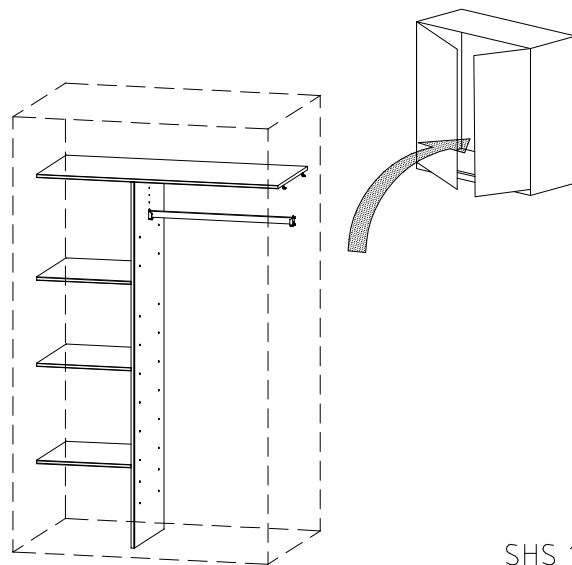

SHS 110

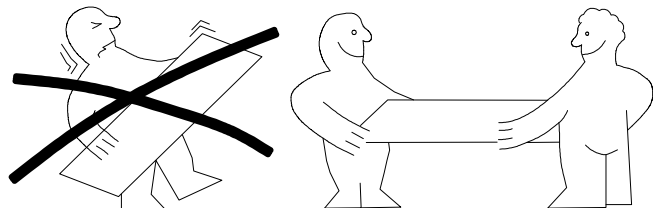

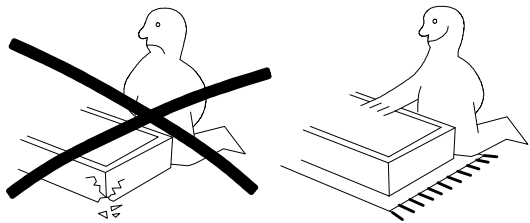
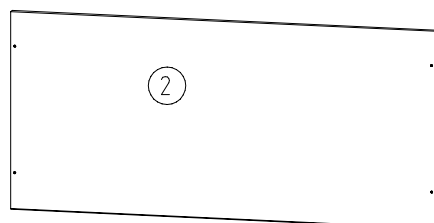
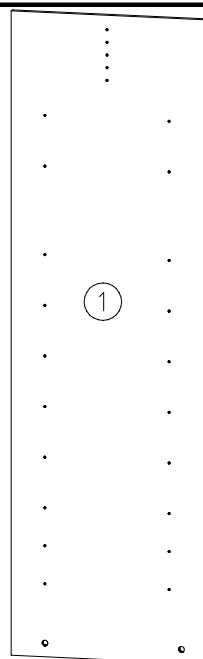
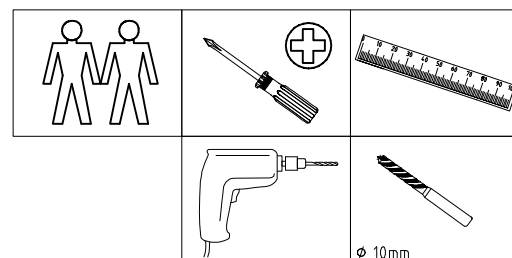
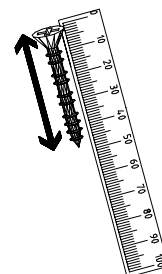
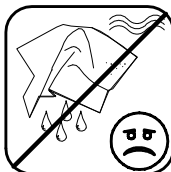
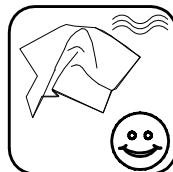
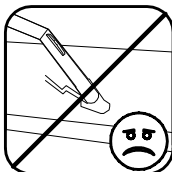
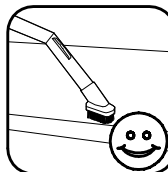
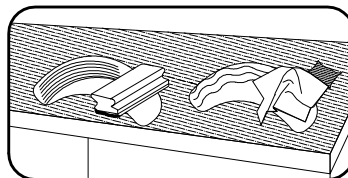
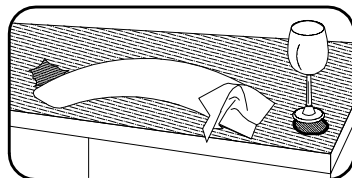
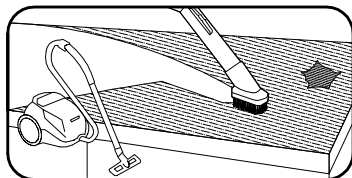
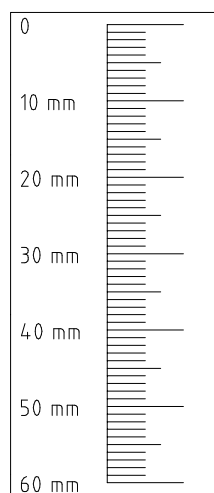
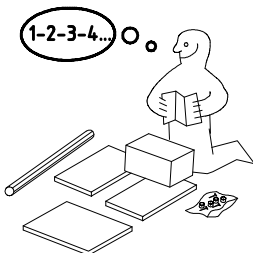
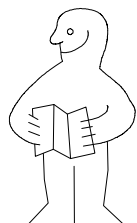

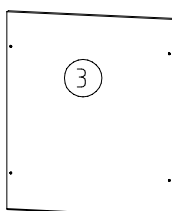



1095 x 500 x 18



3x 429 x 500 x 18

1629x500x15

 111 102	A 2x	 111 610	L7 16x	 111 174	J1 1x
 111 103	C 2x	 112 405	K23 64.3 mm 1x	 4 X 15mm 121 120	SP14 1x

980758

19.08.13 / 05.01.15

01 15

1/4

1

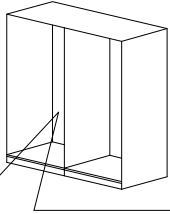

K22
1088mm
112 404

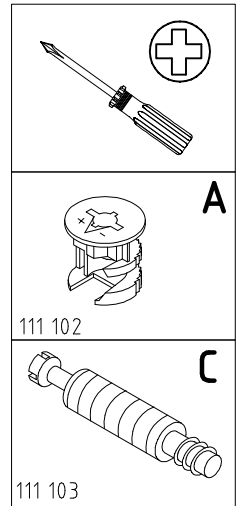
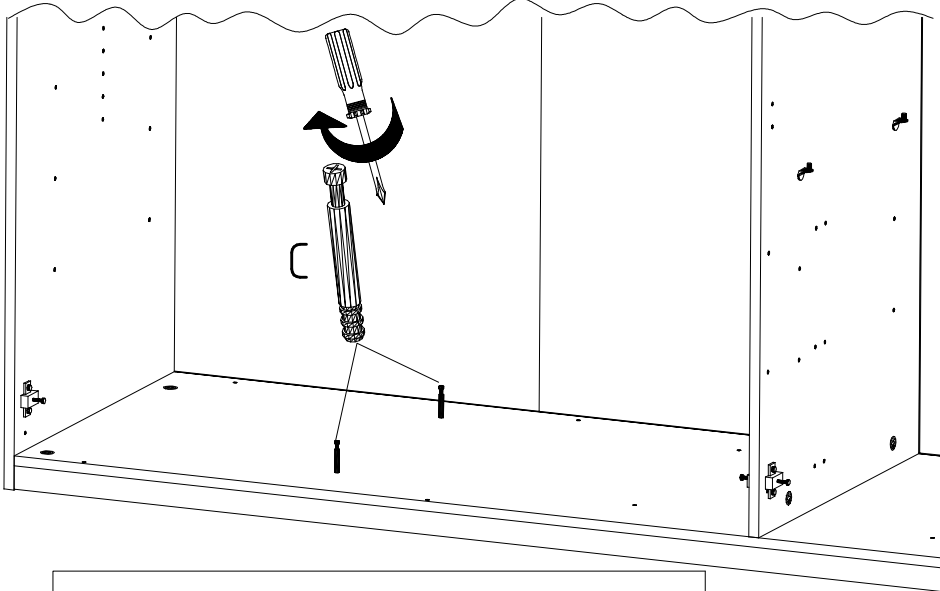
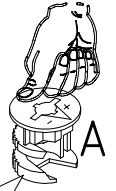
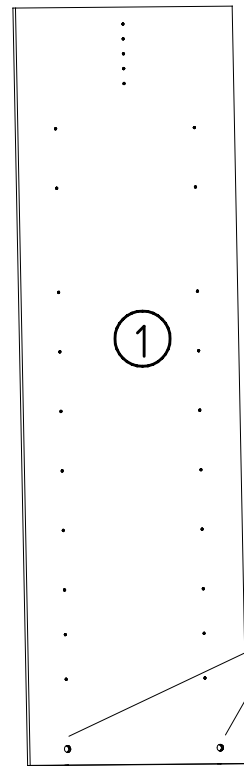
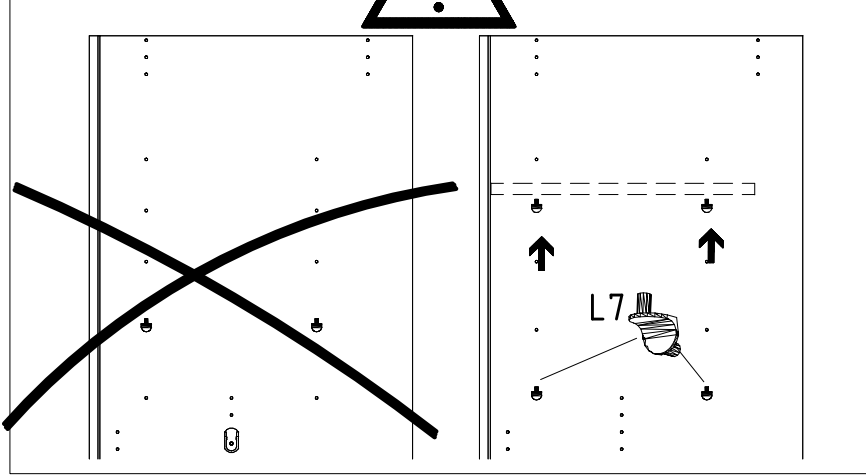
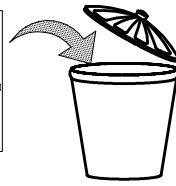

2

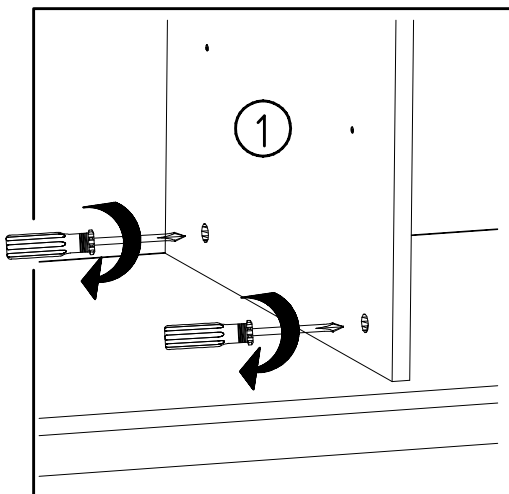
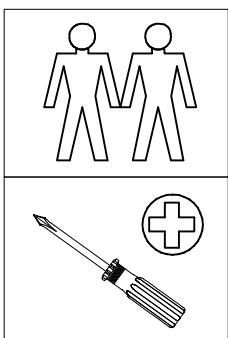
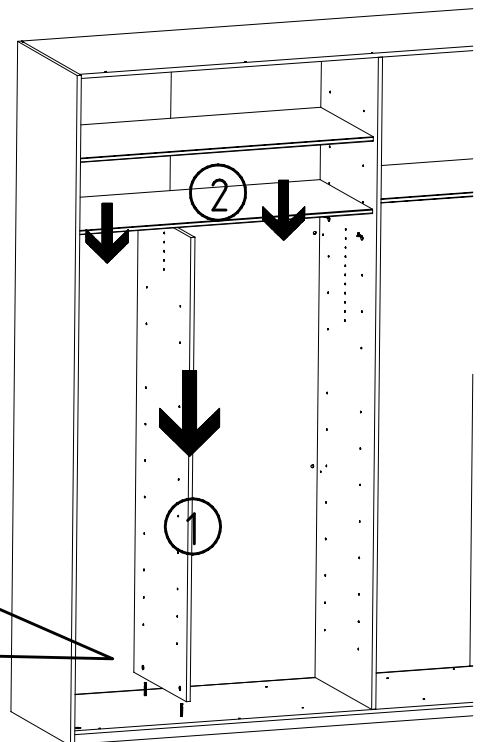
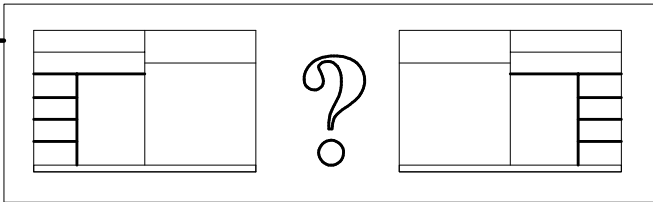

3

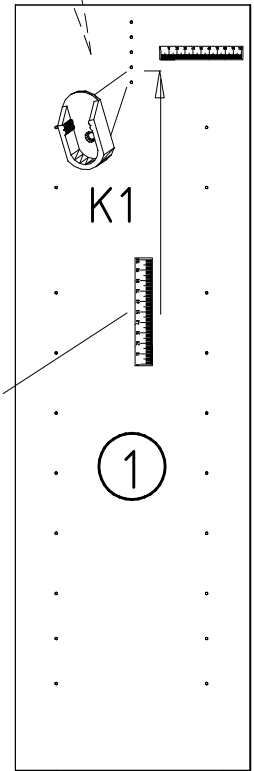
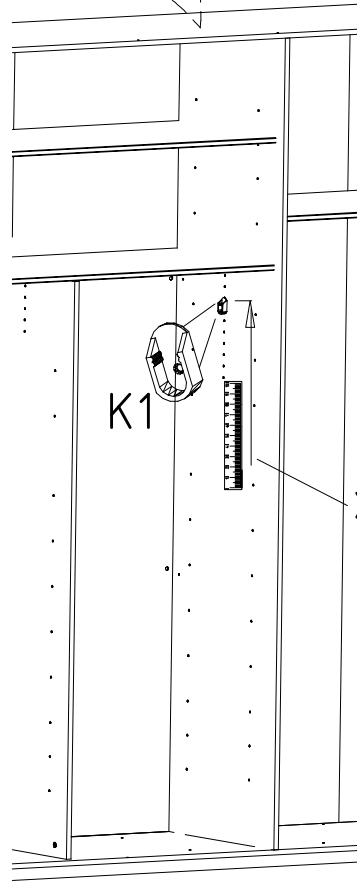
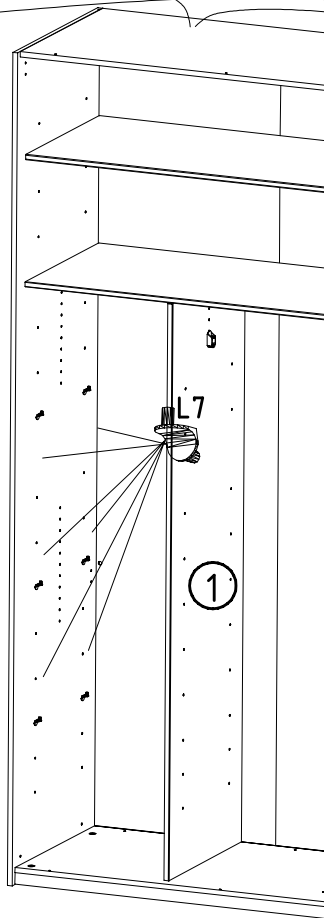
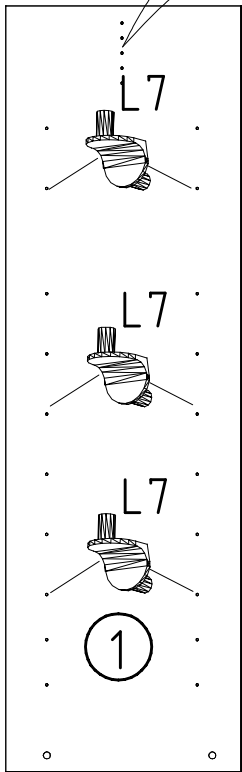
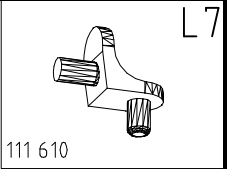
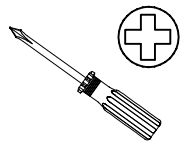
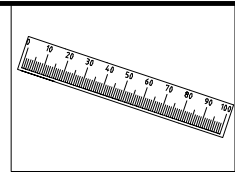
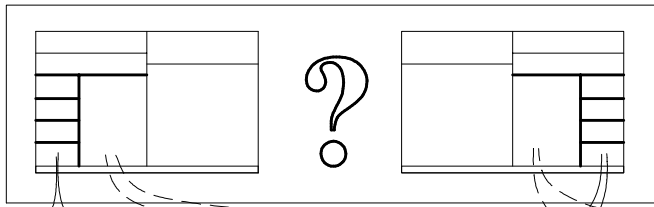

4

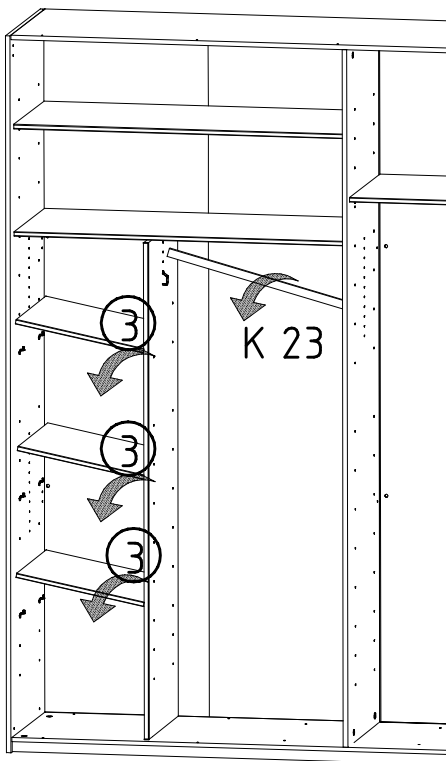
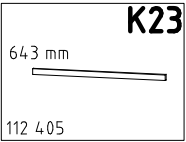

5

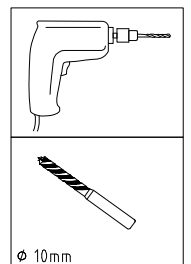
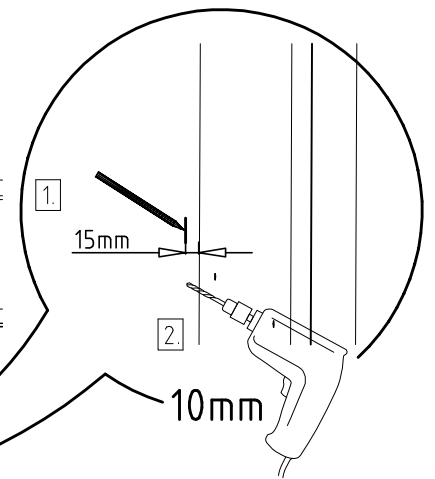
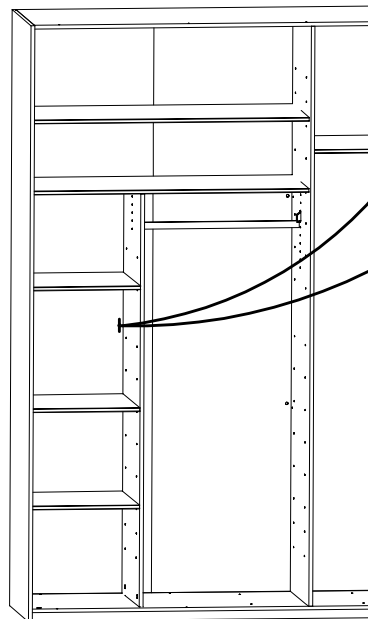

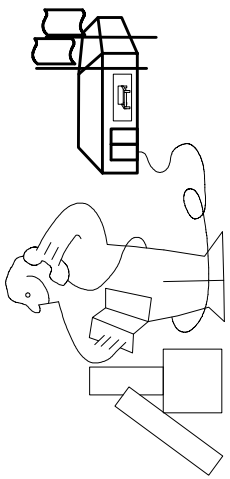
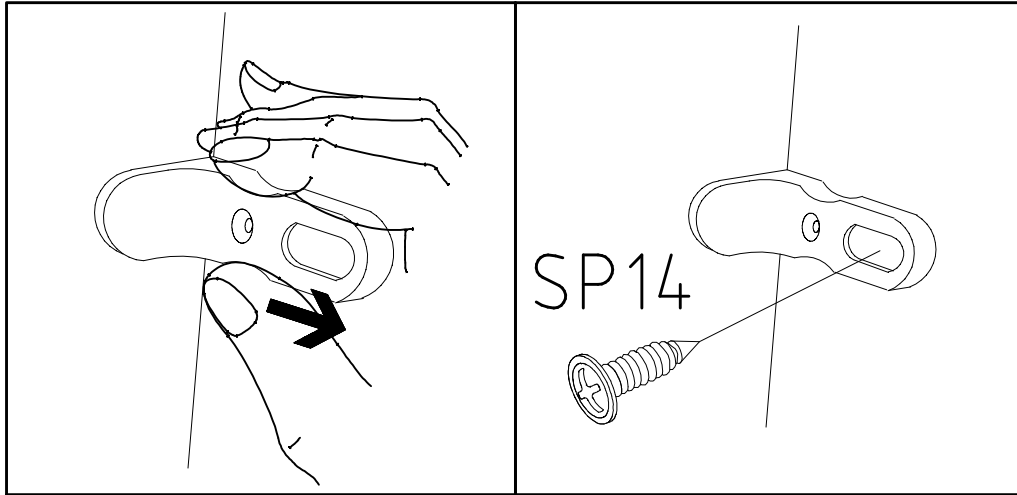
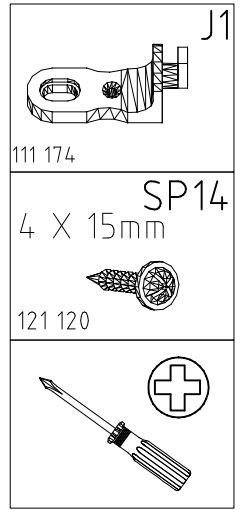
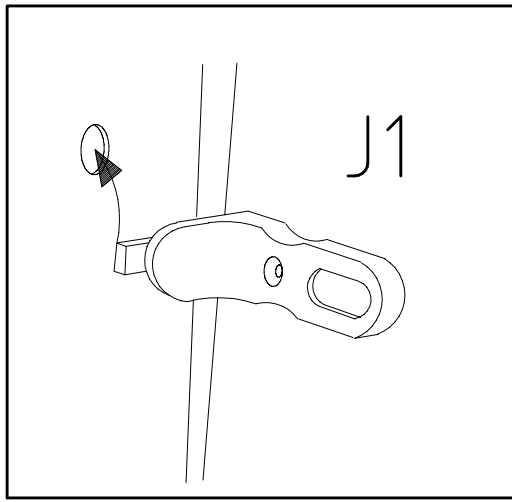

Modell/Model/Modèle

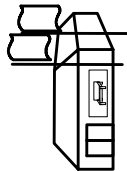
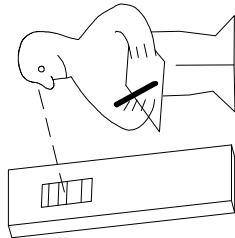

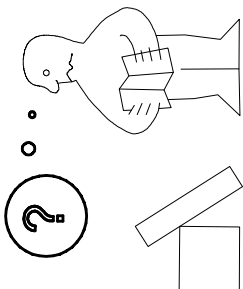

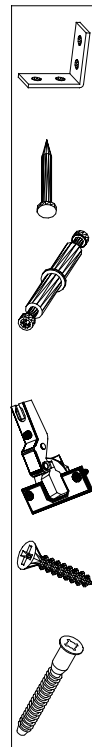

(121 370)	(G 1)	(4x)

Änderungen die dem technischen Fortschritt geschuldet sind, behalten wir uns vor!
 Bei nicht vorschriftsmäßiger und/ oder nicht fachmännischer Montage wird bei Personen- und/ oder Sachschäden keinerlei Haftung übernommen.