

**Art. No.** 74945400; 77629339; 39188847; 35331146; 59350811; 65322162;  
40625214; 28575213; 68627447; 58715923; 30738517; 21465236; 75894434;  
38754721; 38754721; 95564844; 12045545; 14080429; 52758825; 12287757;  
54364516; 56055063; 55409101; 31980939; 53411710; 69944938; 86294522

## Marseille pouf

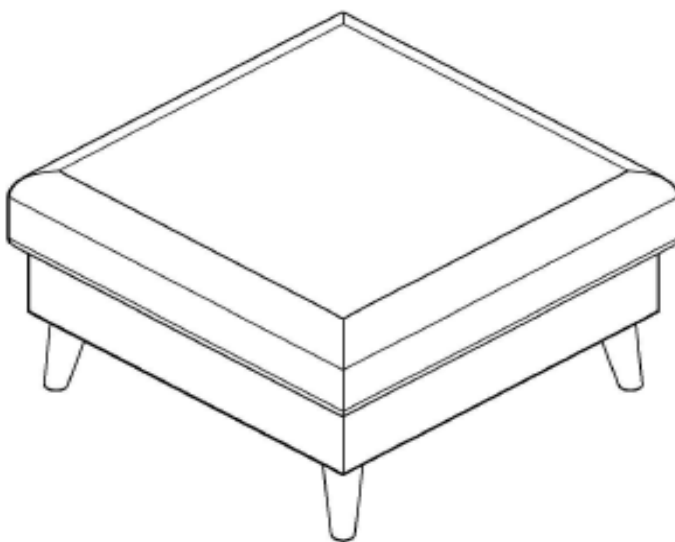

- |   |                                     |
|---|-------------------------------------|
| <b>(D)</b> Montageanleitung             | <b>(GB)</b> Assembly instructions   |
| <b>(FR)</b> Notice de montage           | <b>(IT)</b> Istruzioni di montaggio |
| <b>(NL)</b> Handleiding voor de montage | <b>(PL)</b> Instrukcja montażu      |
| <b>(CZ)</b> Montážní návod              | <b>(SK)</b> Návod na montáž         |
| <b>(HU)</b> Szerelési útmutató          | <b>(RO)</b> Instrucțiuni de montaj  |
| <b>(TR)</b> Montaj talimatı             | <b>(RU)</b> Инструкция по монтажу   |



90kg-Max

LKZ 40937

**Service • Usługa • Обслуживание • Servizio • Un service  
Serviciu • Služba • Servis • Szolgáltatás**



Name • Nom • Nome • Naam  
• Nazwa • Název • Názov  
• Név • Nume • Isim  
• Название

**Marseille**

• Nr • No • N° • Номер • Č • Sz

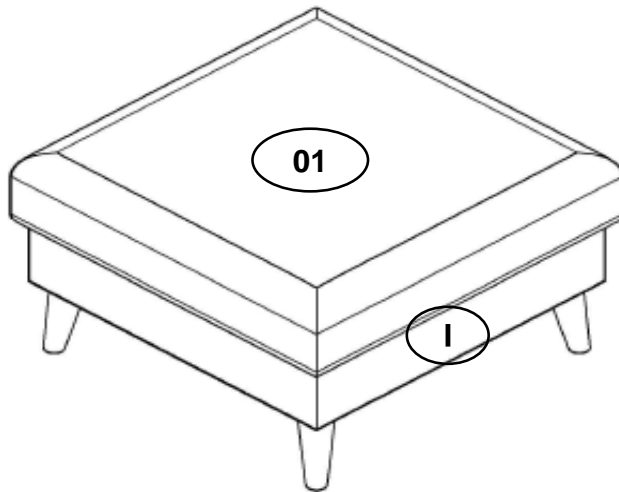
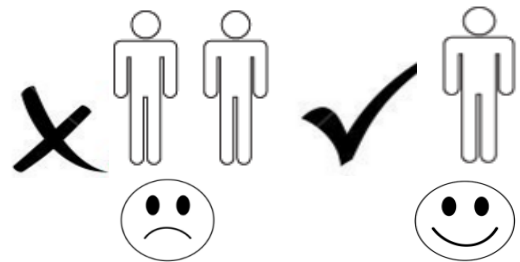
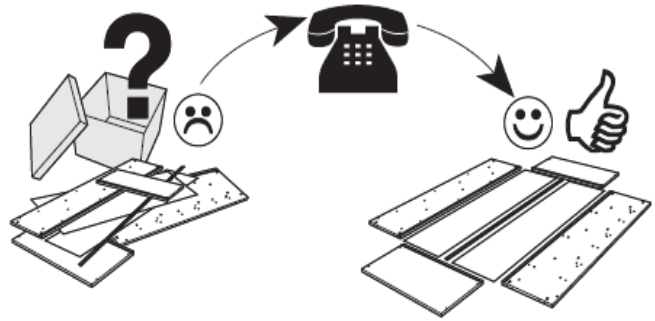
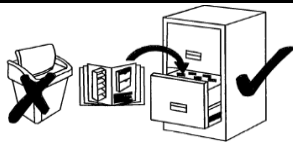
4945400; 77629339; 39188847; 35331146; 59350811; 65322162;  
40625214; 28575213; 68627447; 58715923; 30738517; 21465236;  
75894434; 38754721; 38754721; 95564844; 12045545; 14080429;  
52758825; 12287757; 54364516; 56055063;  
55409101; 31980939; 53411710; 69944938; 86294522



<b>A</b>		<b>B</b>		<b>C</b>	
<b>H- 145 x4</b>		<b>x12, 5x30</b>		<b>x4</b>	

1

