

3

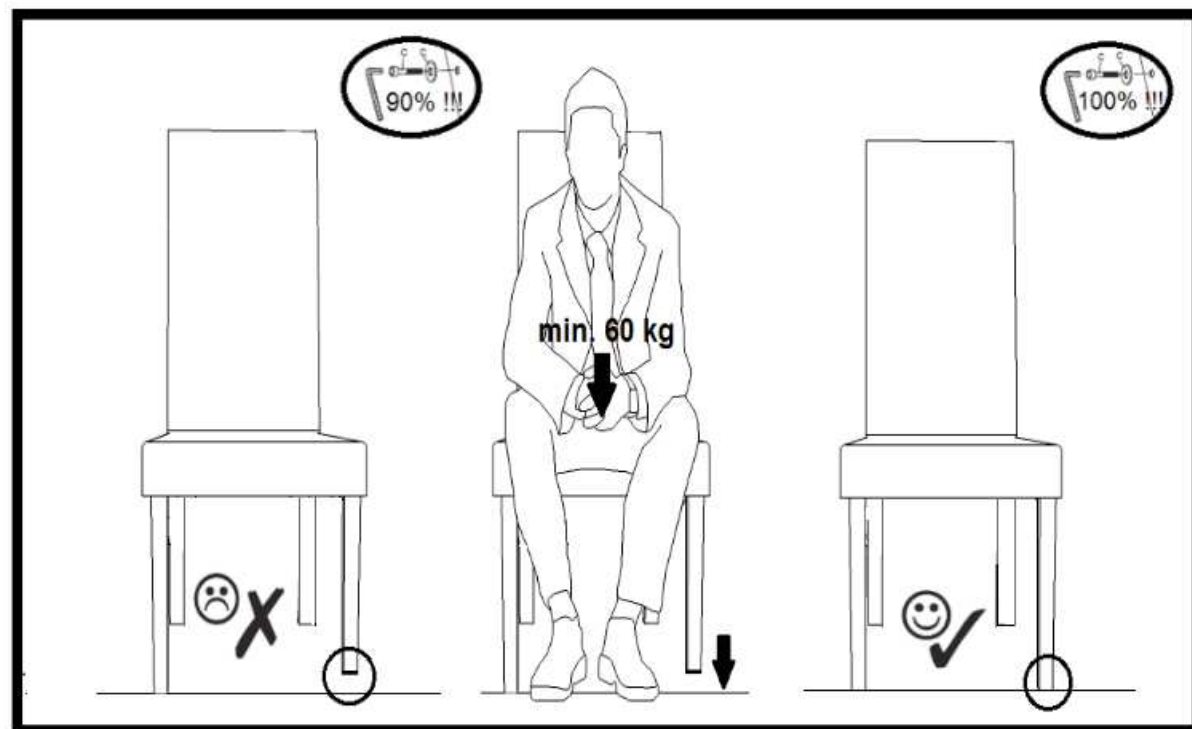

4

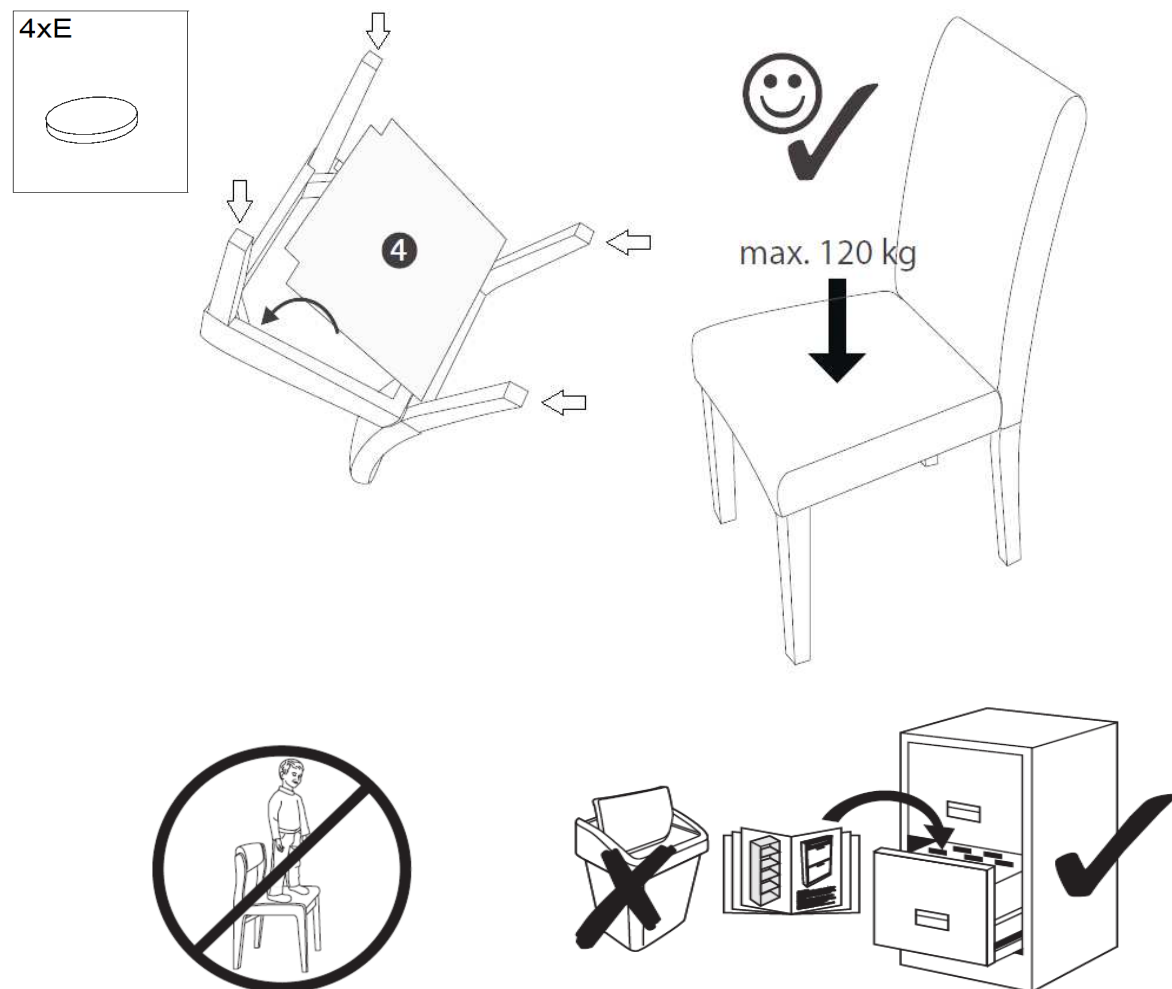

4

269459, 340756, 685360, 775963, 597872, 237943, 872288, 506107, 457315, 254837, 784953, 356611, 294781, 466978, 393983, 439280, 780578, 392232, 893511/20, 893511/21, 893511/23, 893511/24, 227088/20, 227088/21, 227088/23, 227088/24, 826071/20, 826071/21, 826071/23, 826071/24, 795418/20, 795418/21, 795418/23, 795418/24, 264082/20, 264082/21, 264082/23, 264082/24, 668900/20, 668900/21, 668900/23, 668900/24, 899527/30, 736406/30, 490280/30, 866194/30, 694736/30, 818068/30, 684845, 685033

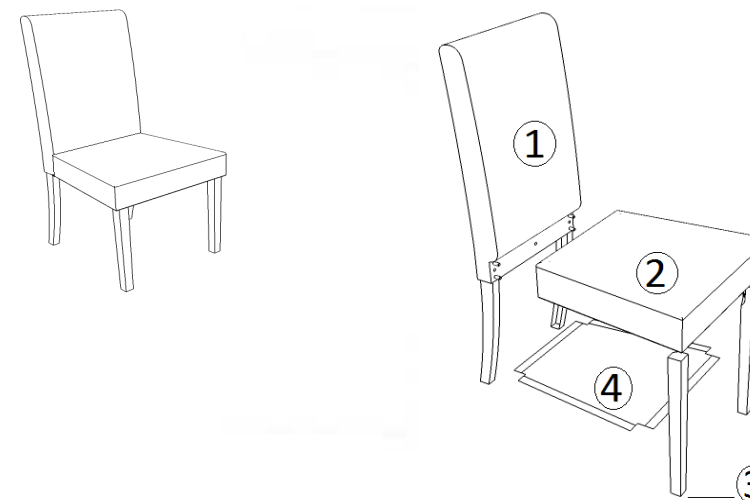

- D Montageanleitung
- GB Assembly instructions
- FR Notice de montage
- IT Istruzioni di montaggio
- NL Handleiding voor de montage
- PL Instrukcja montażu
- CZ Montážní návod
- SK Návod na montáž
- HU Szerelési útmutató
- RO Instrucțiuni de montaj
- TR Montaj talimatı
- RU Инструкция по монтажу





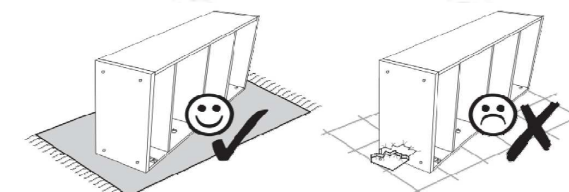

15 min

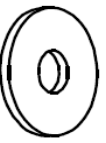

| | | | |
|----|--|----|---|
| D | Eventuelle Druckstellen in der Polsterung, welche beim Transport entstehen können, verschwinden bei Gebrauch nach einiger Zeit von allein. | GB | Any dents in the upholstery, which may arise during transport, disappear after some time of usage. |
| FR | De bosses dans la sellerie, qui peuvent survenir pendant le transport, disparaître après un certain temps d'utilisation. | IT | Le ammaccature nella tappezzeria, che possono verificarsi durante il trasporto, scompaiono dopo un certo tempo di utilizzo. |
| NL | Elke deuken in de bekleding, die zich kunnen voordoen tijdens het transport, verdwijnt na enige tijd van gebruik. | PL | Wszelkie wgniecenia w tapicerce, która może powstać w trakcie transportu, znikają po pewnym czasie użytkowania. |
| CZ | Jakékoliv důlky v čalounění, které mohou vzniknout během přepravy, zmizí po určité době používání. | SK | Akékoľvek jamky v čalúnení, ktoré môžu vzniknúť počas prepravy, zmizne po určitej dobe používania. |
| HU | Bármely horpadás a kárpit, során esetlegesen felmerülő szállítás eltűnnek egy idő után a használat. | RO | Orice urme de lovituri în tapițerie, care pot apărea în timpul transportului, dispărea după un timp de utilizare. |
| TR | Döşemelik herhangi ezik, taşıma sırasında ortaya çıkabilecek, kullanımı bir süre sonra kaybolur. | RU | Любые вмятины в обивке, которые могут возникнуть во время перевозки, исчезают через некоторое время использования. |

1

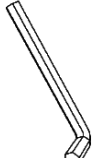
| | |
|----|--|
| D | Zur Befestigung der Schrauben bitte nur den beiliegenden Inbusschlüssel verwenden. Durch die Benutzung einer Bohrmaschine oder eines Akkuschraubers kann es dazu kommen, daß die Schrauben zu fest angezogen werden und die Gewindebuchsen überdrehen. |
| GB | To fix the screws, please use only the enclosed Allen key. By using a power drill or a cordless screwdriver, it may happen that the screws are tightened too much and cause to overwind the screw thread. |
| FR | Pour fixer les vis, s'il vous plaît utiliser uniquement la clé Allen fournie. En utilisant une perceuse ou une visseuse sans fil, il peut arriver que les vis sont trop serrées et causer d'enrouler le filet. |
| IT | Per fissare le viti, si prega di utilizzare solo la chiave Allen inclusa nella confezione. Utilizzando un trapano elettrico o un cacciavite a batteria, può accadere che le viti siano serrate troppo e far antiavvolgimento la filettatura della vite. |
| NL | Om de schroeven vast te stellen, gebruik dan alleen de bijgeleverde inbussleutel. Door het gebruik van een boormachine of een accuschroevendraaier, kan het gebeuren dat de schroeven te hard aangedraaid en veroorzaken op de schroefdraad doordraaien. |
| PL | Aby naprawić śruby, prosimy używać tylko załączonego klucza imbusowego. Za pomocą wiertarki lub wkrętarki akumulatorowej, może zdarzyć się, że śruby są dokręcone zbyt dużo i spowodować overwind śruby. |
| CZ | Chcete-li šrouby, prosím použijte pouze přiložený imbusový klíč. Pomocí vrtačku nebo akumulátorový šroubovák, může se stát, že jsou šrouby utaženy příliš a způsobit, aby overwind závit šroubu. |
| SK | Ak chcete skrutky, prosím používajte iba priložený imbusový kľúč. Pomocou vŕtačky alebo akumulátorový skrutkovač, môže sa stať, že sú skrutky utiahnuté príliš a spôsobí, aby overwind závit skrutky. |
| HU | Ahhoz, hogy rögzítse a csavarokkal, kérjük, csak a mellékelt imbuszkulccsal. Segítségével egy fúrógépet, vagy egy akkus csavarhúzó, előfordulhat, hogy a csavarok meghúzásakor túl sok, ami a túlhúzó a csavar menet. |
| RO | Pentru a remedia șuruburile, vă rugăm să folosiți numai închisă cheia Allen. Prin folosirea unui burghiu de putere sau o șurubelniță cu acumulator, se poate întâmpla ca șuruburile sunt strânse prea mult și determina să overwind filet. |
| TR | Vidaları sabitlemek için, sadece kapalı Allen anahtarını kullanın. Bir matkap veya bir akülü tornavida kullanarak, vidaları çok sıkı olduğundan emin olur ve vida sarmak neden olabilir. |
| RU | Чтобы исправить винты, пожалуйста, используйте только прилагаемый шестигранный ключ. Используя дрель или шуруповерт, может случиться, что все винты затянуты слишком много, и привести перекручивать резьбу. |

| | | | | |
|---|--|--|--|--|
| 8xA  Ø25 | 12xB  M8x65 | 4xC  | 1xD  | 8xE  |
|---|--|--|--|--|

