

MIKADO

2024-11/2

D MONTAGEANLEITUNG
BEDIENUNGSANLEITUNG

NL HANDLEIDING VOOR DE MONTAGE
GEBRUIKSAANWIJZING

TR MONTAJ TALIMATI
KULLANIM KLAVUZU

RO INSTRUCȚIUNI DE INSTALARE
INSTRUCȚIUNI DE UTILIZARE

FR NOTICE DE MONTAGE
MANUEL INSTRUCTIONS

HU KÖZGYŰLÉS UTASÍTÁSOK
KEZELÉSI UTASÍTÁS

SI NAVODILA ZA MONTAŽO
NAVODILA ZA UPORABO

ES INSTRUCCIONES DE MONTAJE
MANUAL DEL USUARIO

GB ASSEMBLY INSTRUCTIONS
INSTRUCTION MANUAL

PL INSTRUKCJA MONTAŻU
INSTRUKCJA OBSŁUGI

RU ИНСТРУКЦИЯ ПО МОНТАЖУ
ИНСТРУКЦИЯ ПО ЭКСПЛУАТАЦИИ

IT ISTRUZIONI DI MONTAGGIO
MANUALE DI ISTRUZIONI

SK MONTÁŽNY NÁVOD
NÁVOD NA POUŽITIE

CZ MONTÁŽNÍ NÁVOD
NÁVOD K POUŽITÍ

PT INSTRUÇÕES DE MONTAGEM
MANUAL DO USUÁRIO

HR UPUTE ZA MONTAŽU
UPUTE ZA UPOTREBU

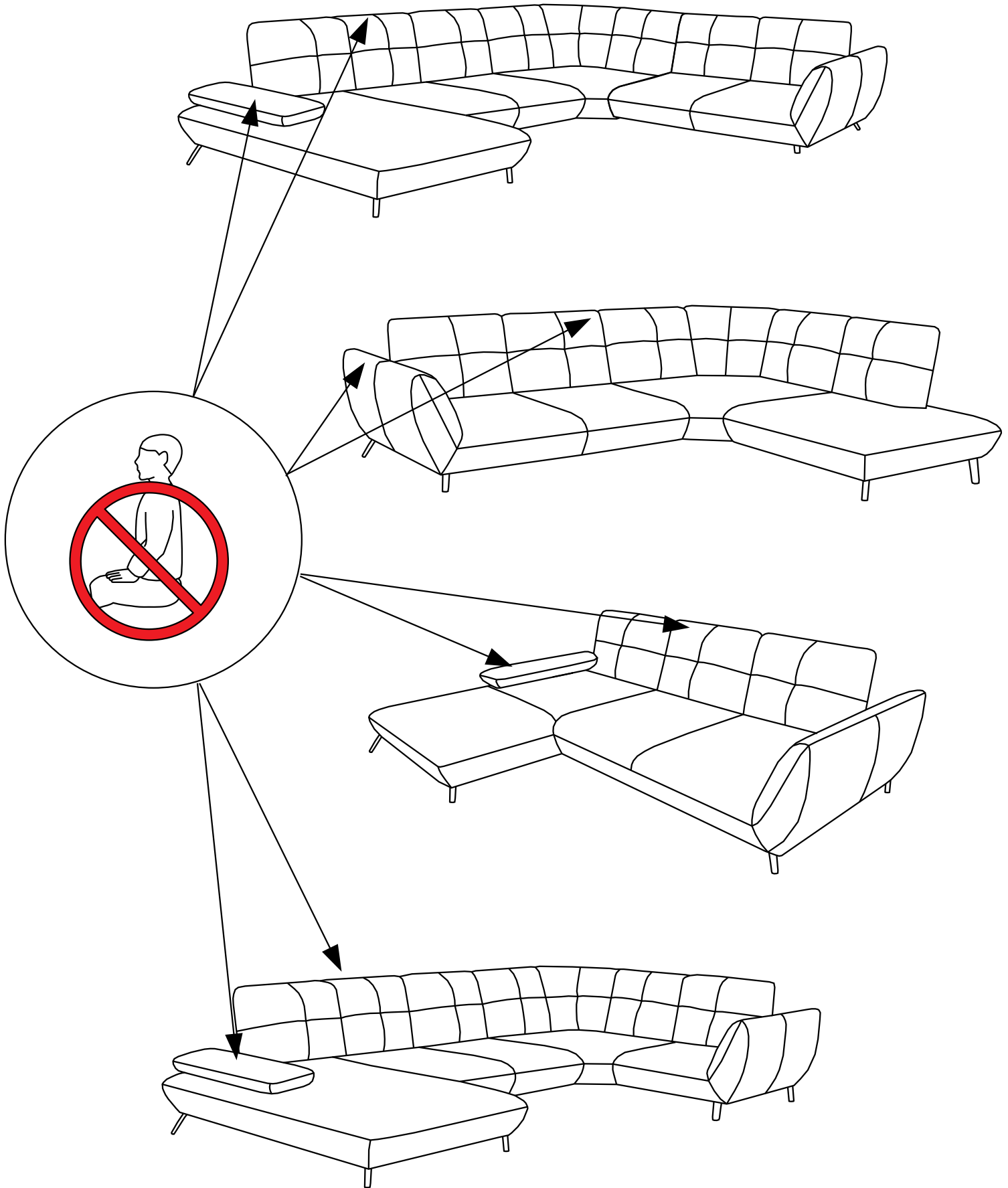

Service · Dienstverlening · Servis · Servis · Сервисная служба · Serviciu · Services · Servizio
 ·Servisný list · Szolgáltatás · Servisní list

Name · Naam · Nazwa · Ísim · Название · Nume · Nome · Názov · Názov ·
 Název · Neve

MIKADO

Typ · Type · Tip · Тип · Tipo · Típus

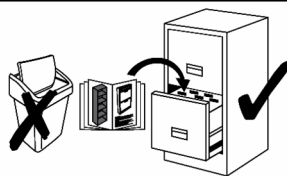

1

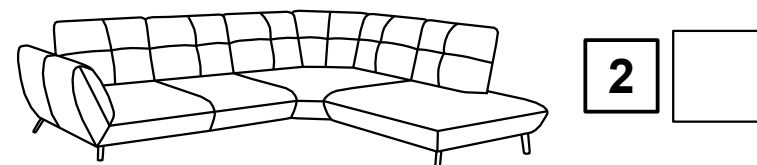
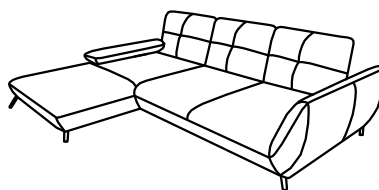

2

3

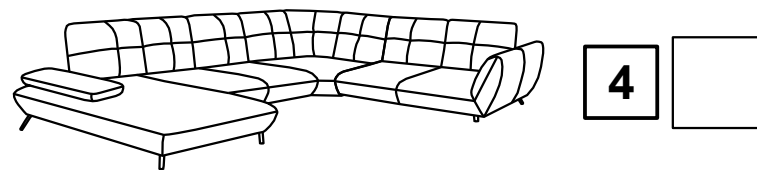
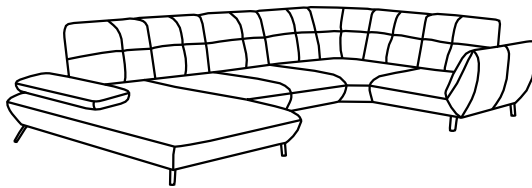

4





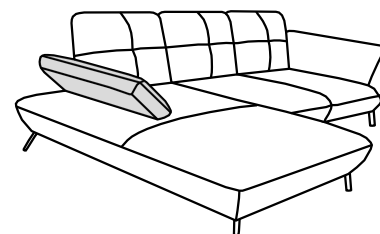
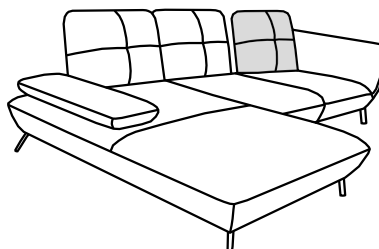





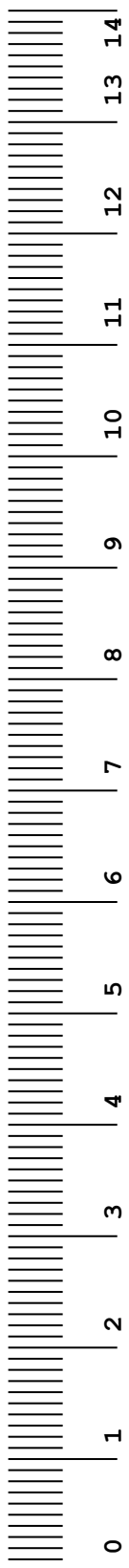
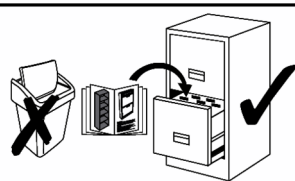



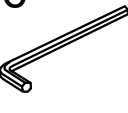

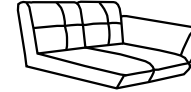

0037

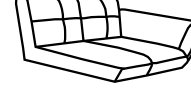

0090

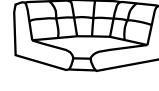
Name · Naam · Nazwa · Ísim · Название · Nume · Nome · Názov · Názov ·
 Název · Neve
MIKADO
 Typ · Type · Tip · Тип · Tipo · Típus



		a 	b  M6x25	c  L-4	d 	f 
(A-1) 						
(A-2) 	2	8		2	1	
(A-3) 						
(A-4) 	4	16		4	1	
(B) 	-	-		-	1	
(C-1) 	4	16	1	4	2	
(C-2) 						
(D) 	1	4		1	-	
(E-1) 	4	16		4	1	
(E-2) 						
(F-1) 	4	16		4	-	
(F-2) 						

1

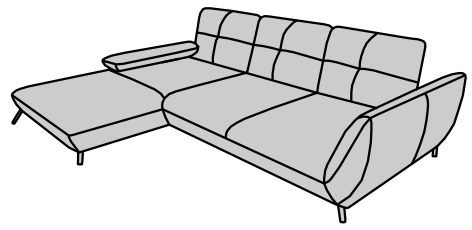
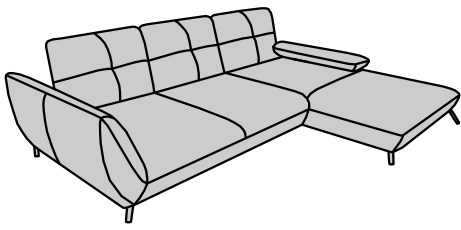

A-1

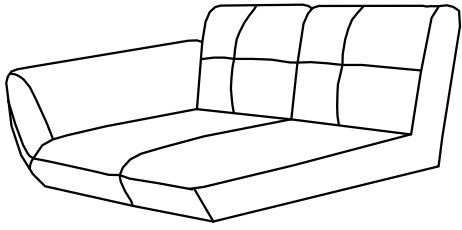

A-2

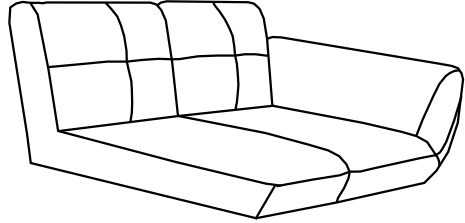

C-1

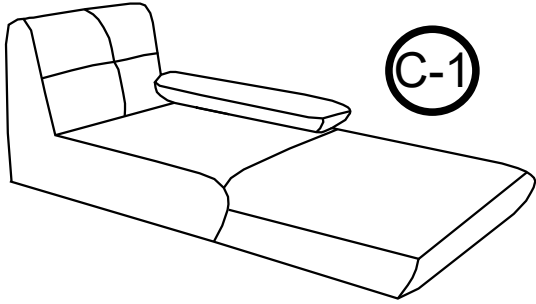

C-2

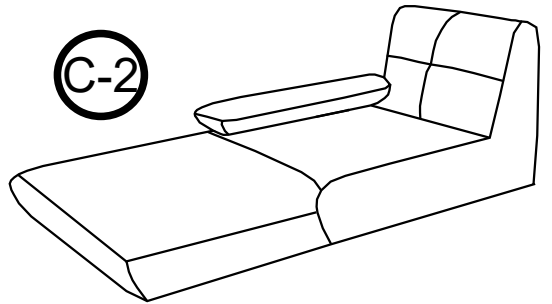

2

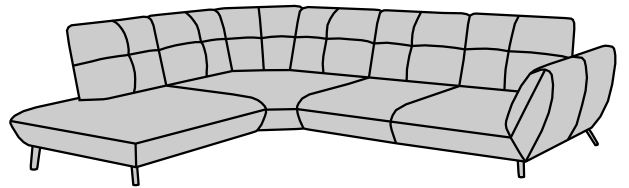
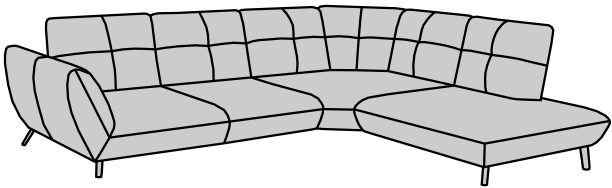

A-1

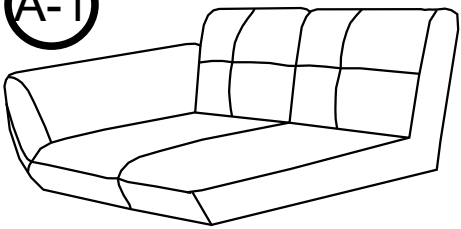

A-2

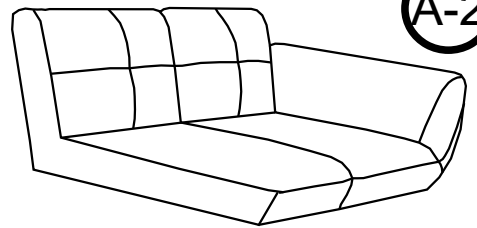

D

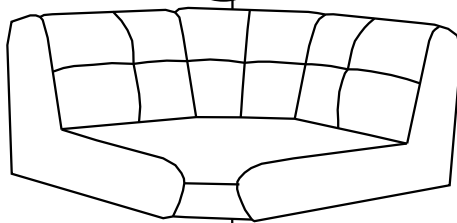

E-1

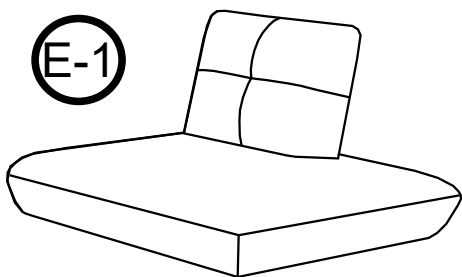

E-2

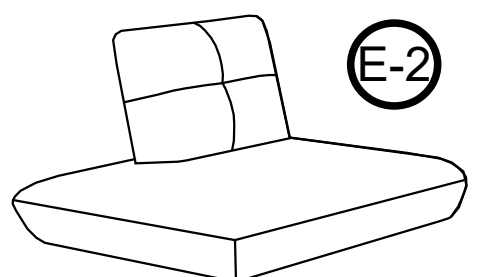

3

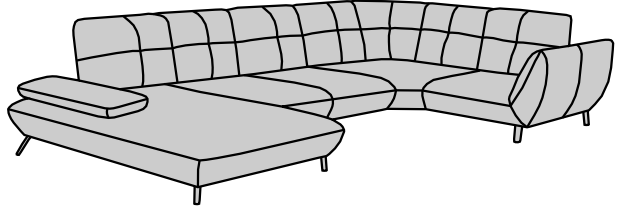
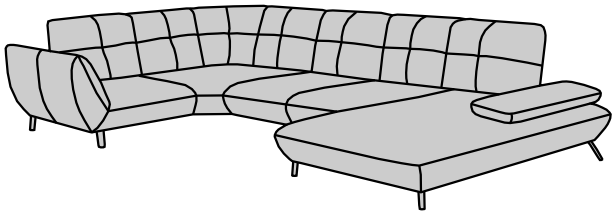

F-1

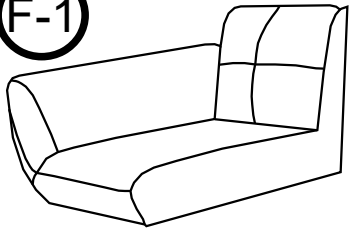

F-2

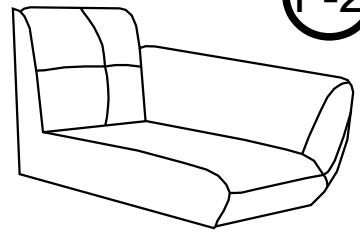

D

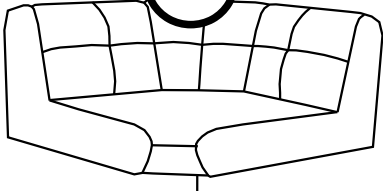

B

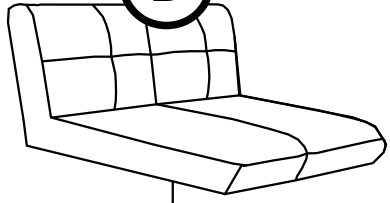

C-1

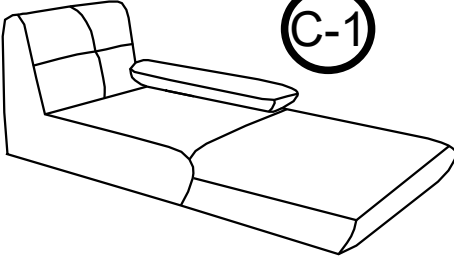

C-2

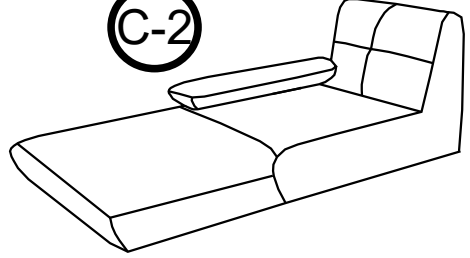

4

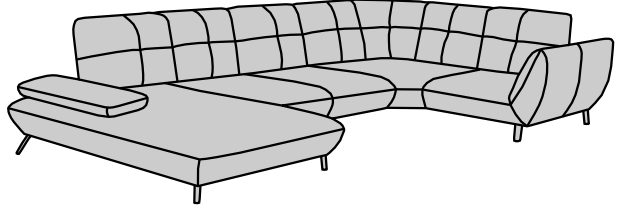
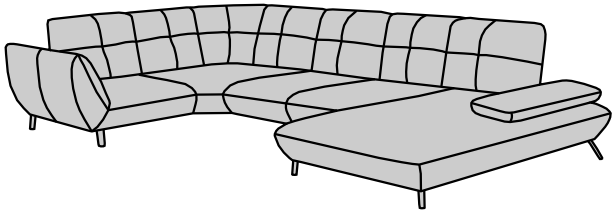

A-1

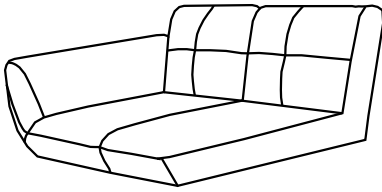

A-2

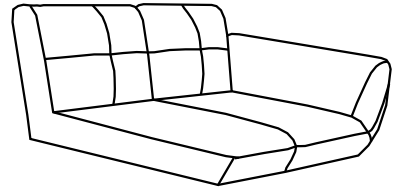

D

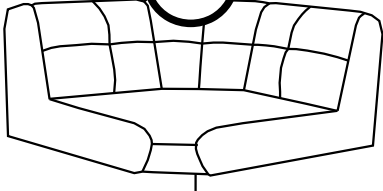

B

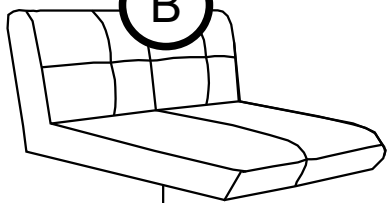

C-1

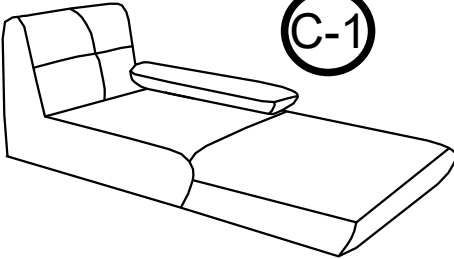

C-2

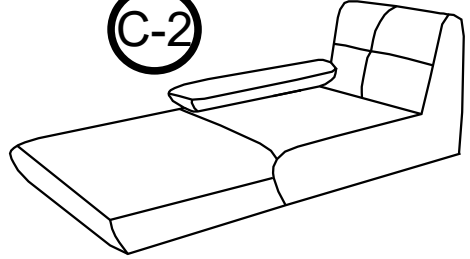

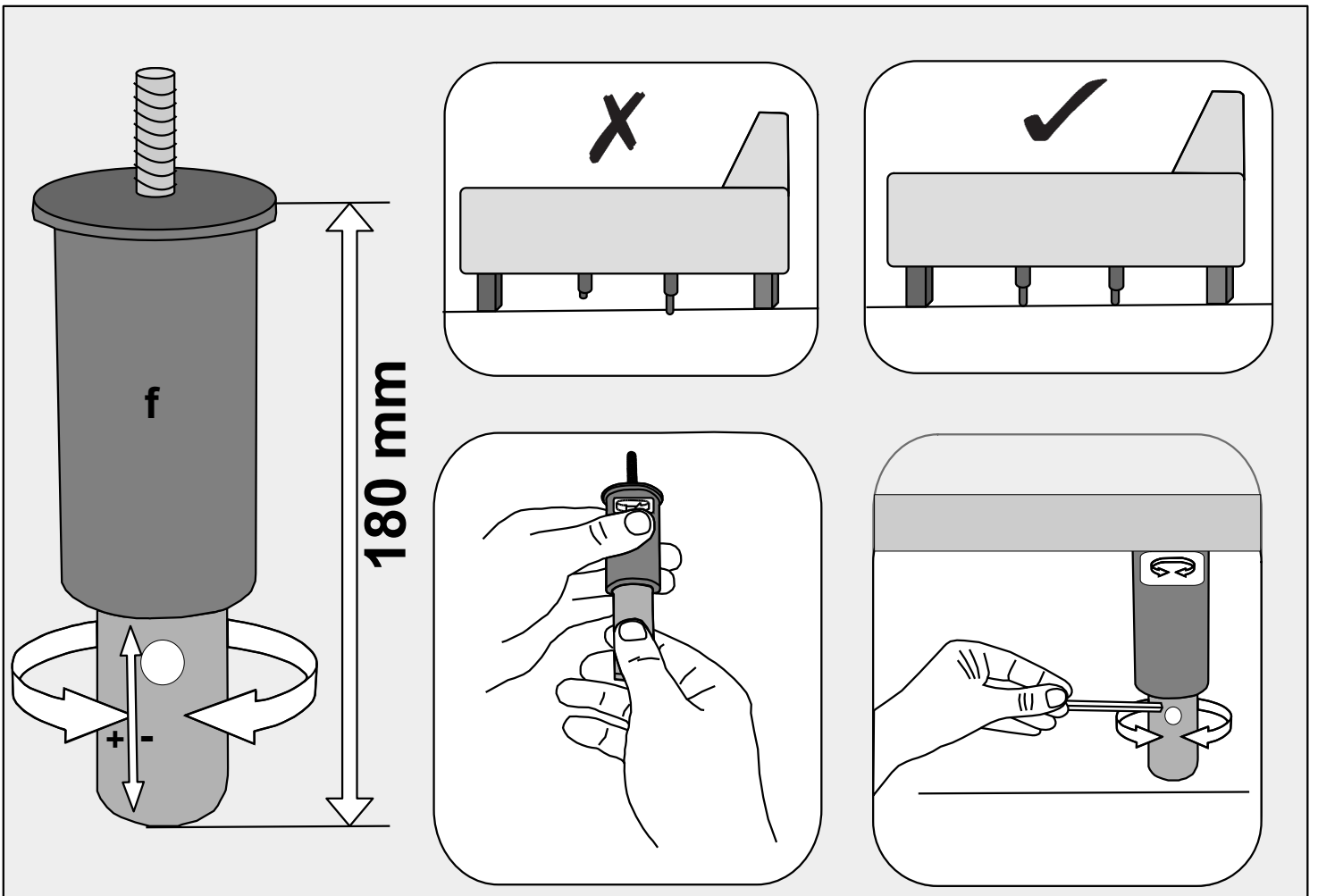
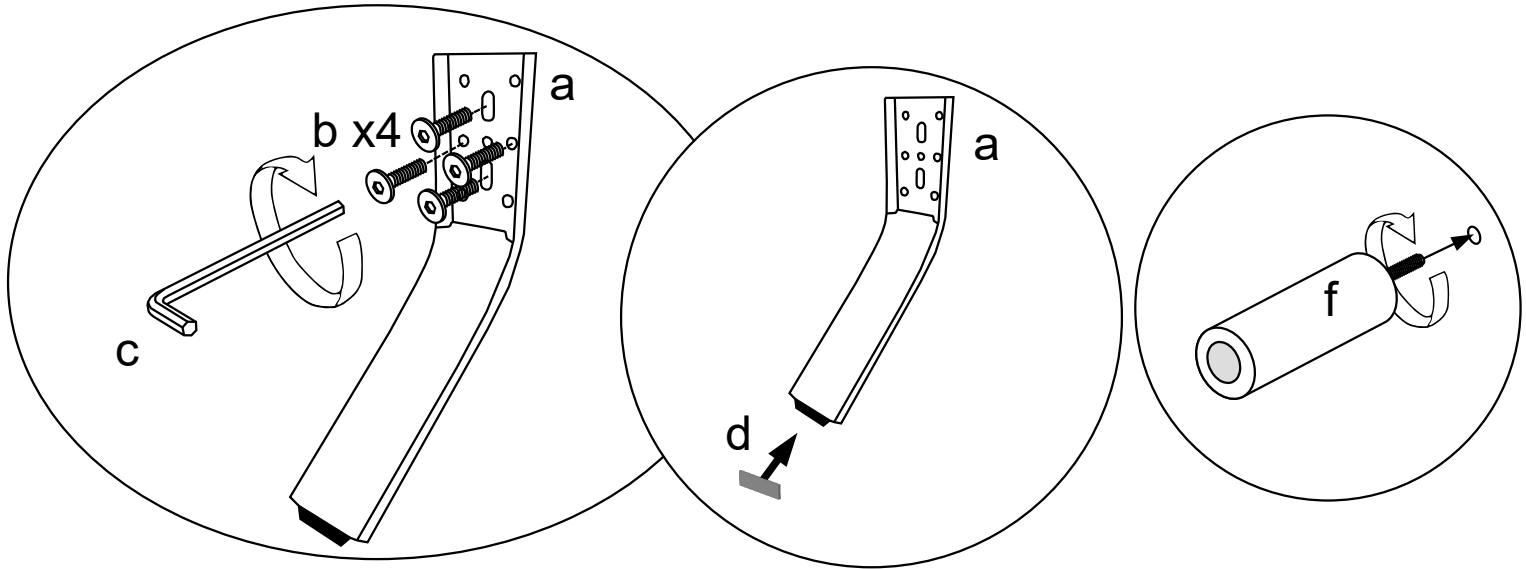
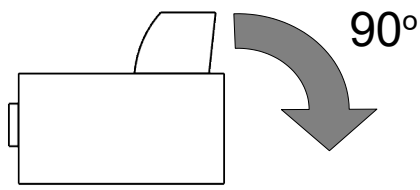

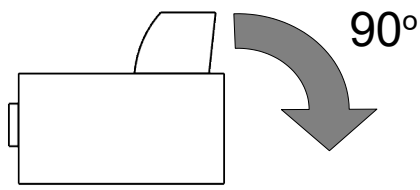

1

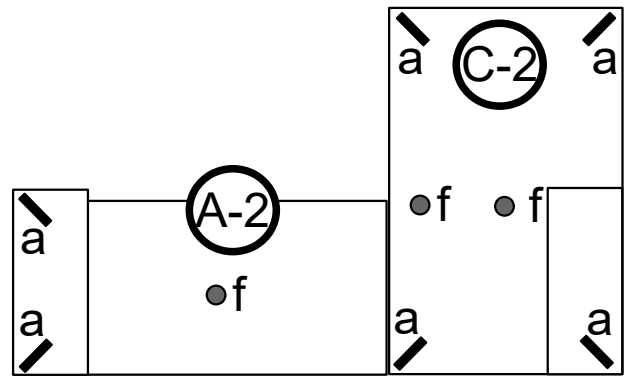
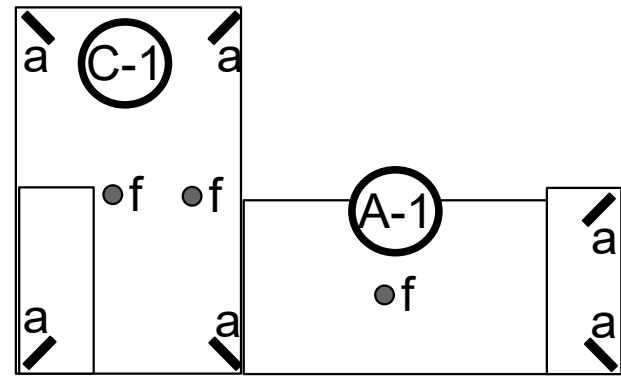
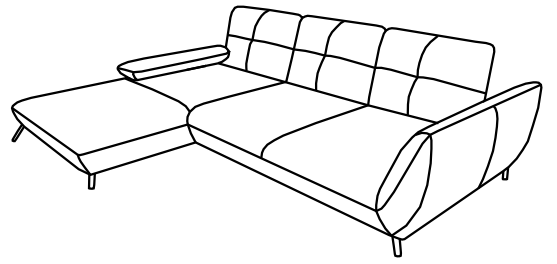
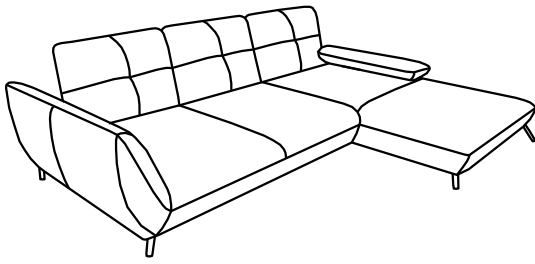

2

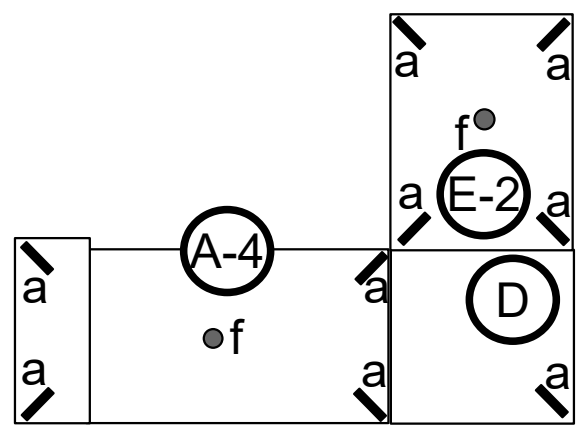
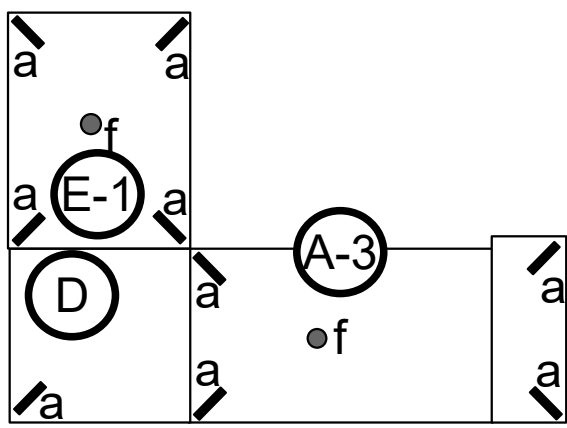
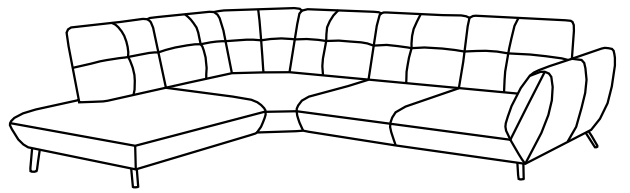
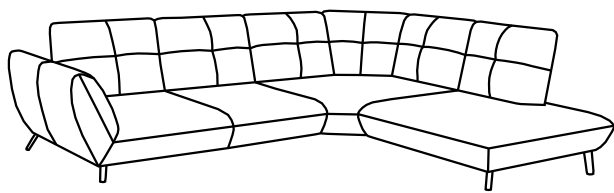

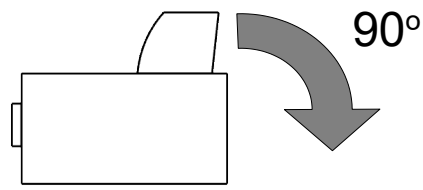

3

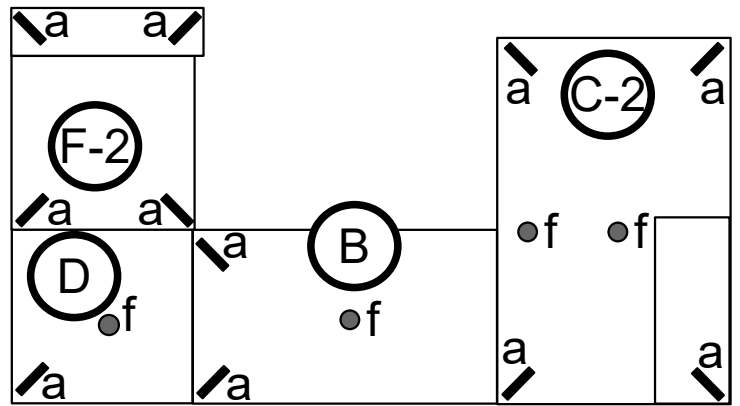
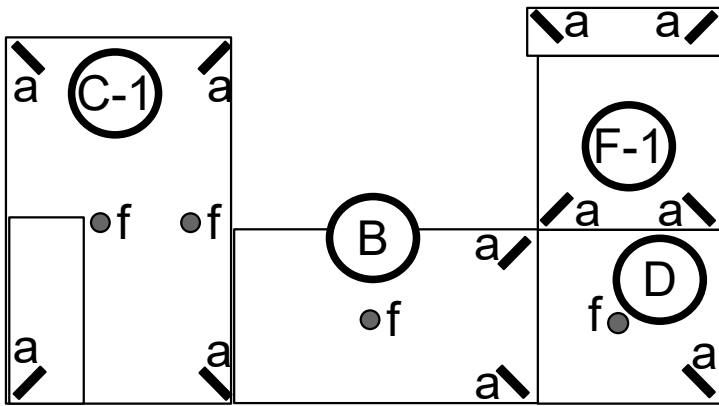
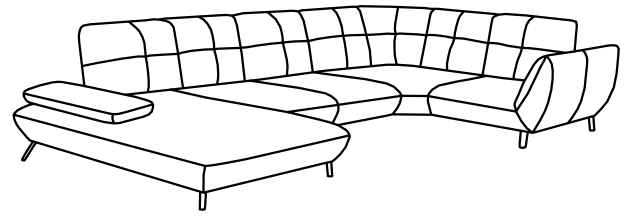
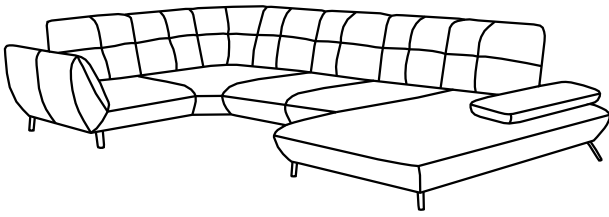

4

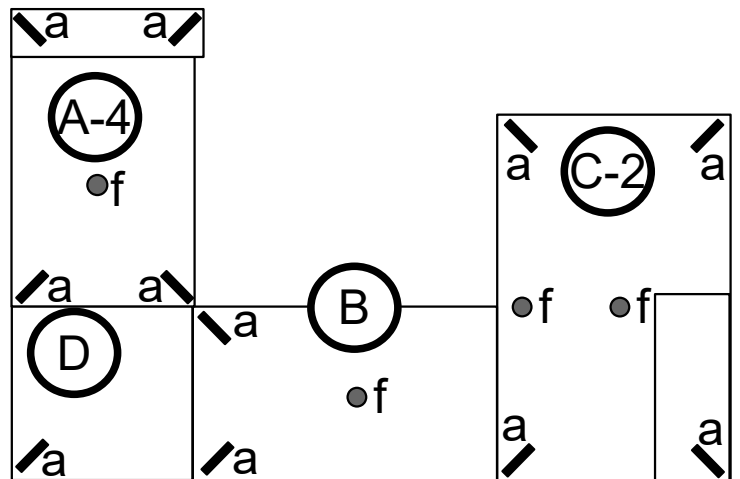
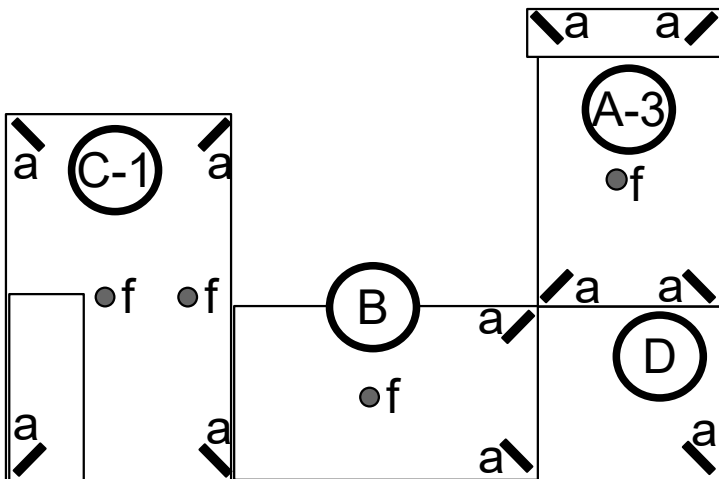
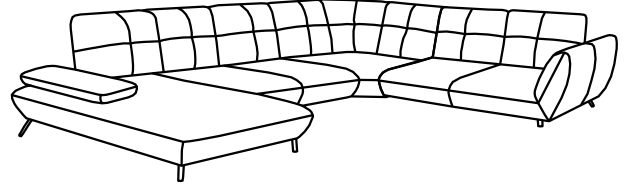
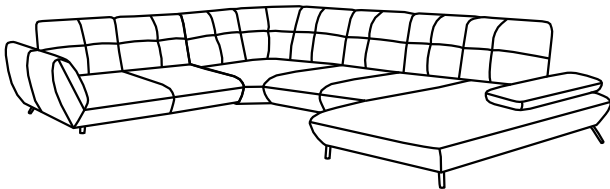

- A-1 A-2 B C-1 C-2
- D E-1 E-2 F-1 F-2

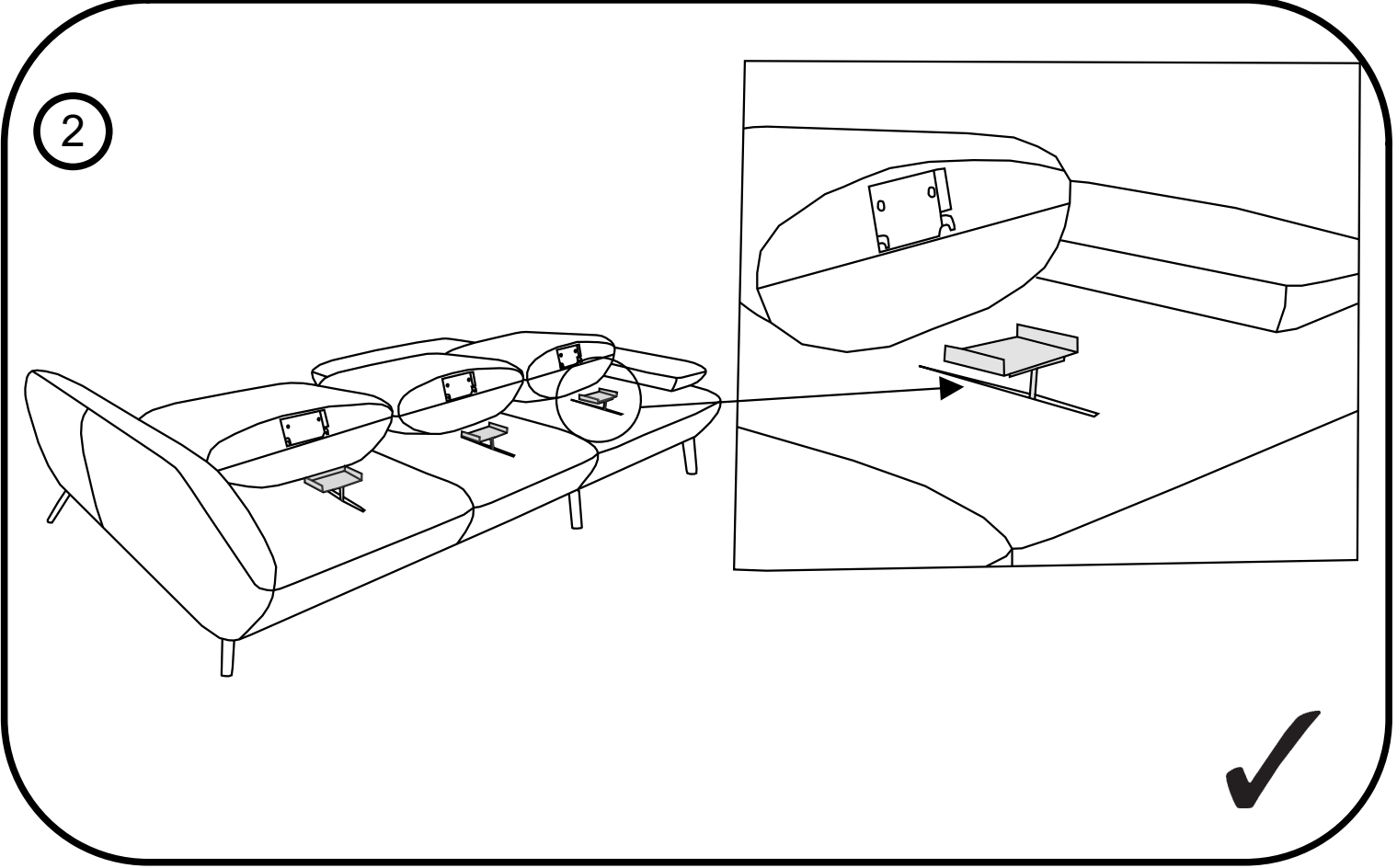
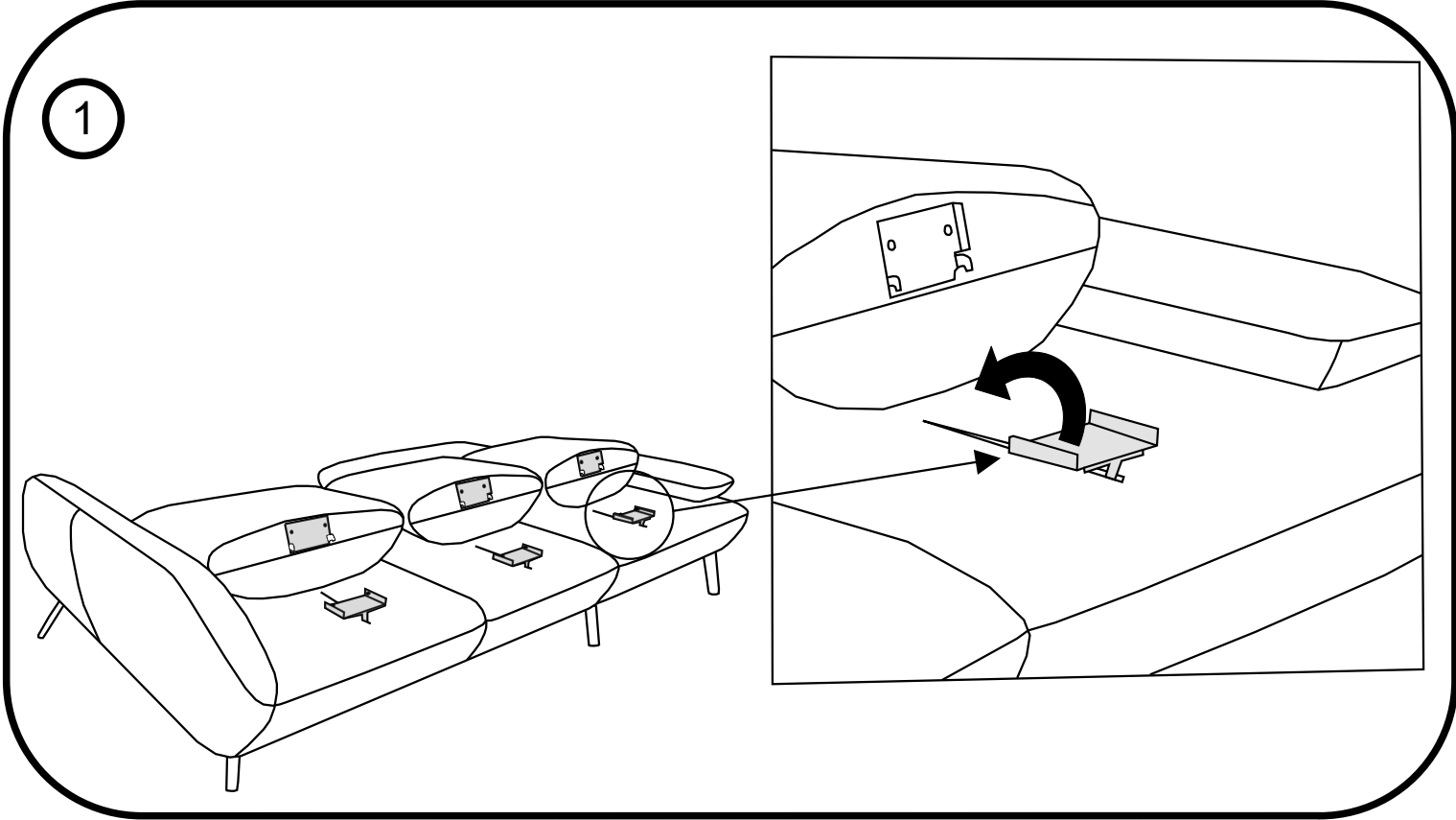
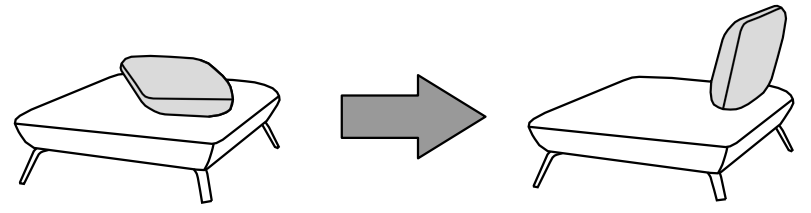

- A-1 A-2 B C-1 C-2
- D E-1 E-2 F-1 F-2

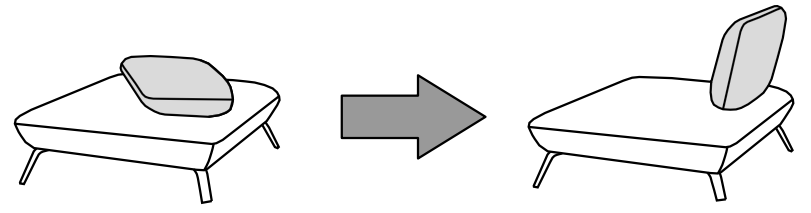

3

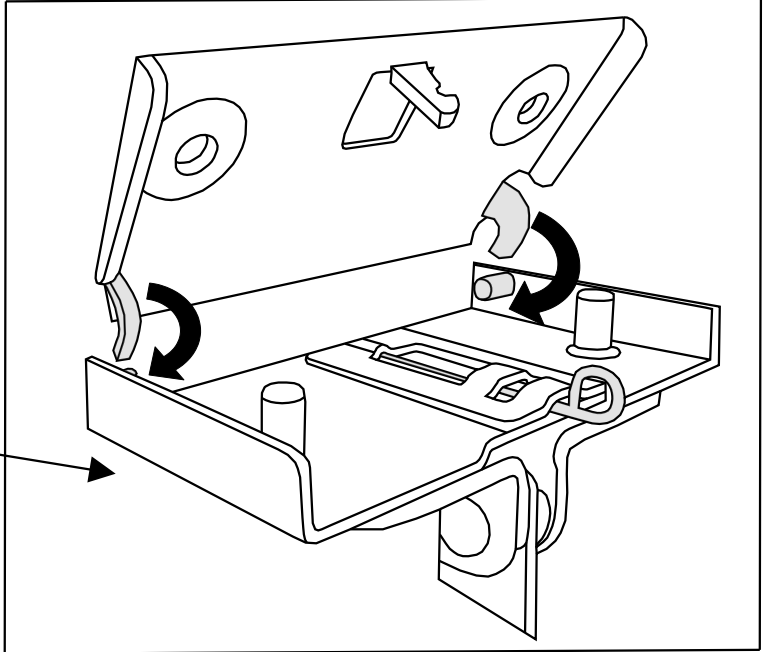
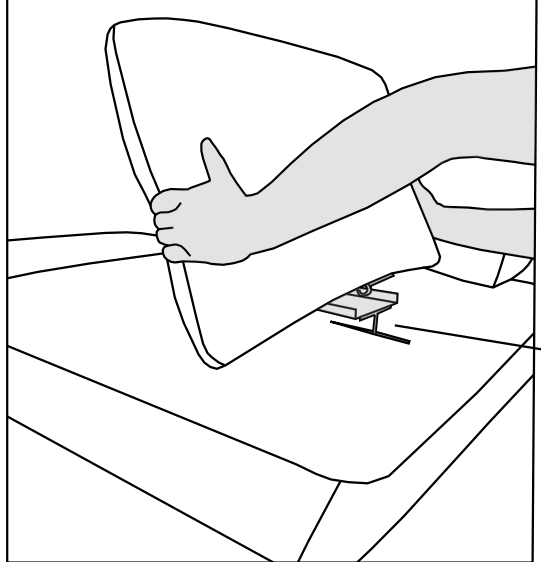

4

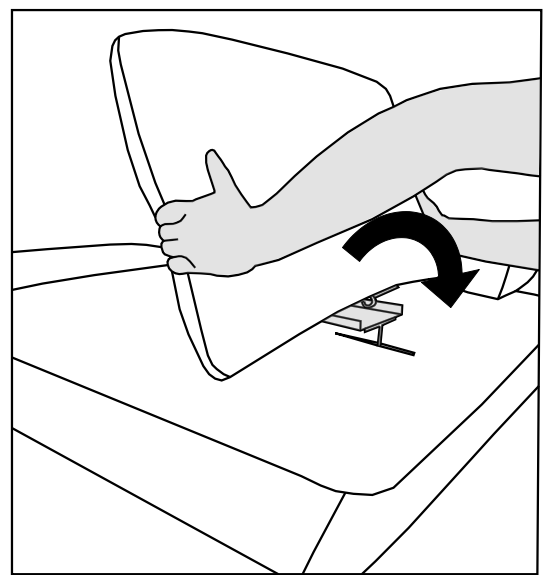
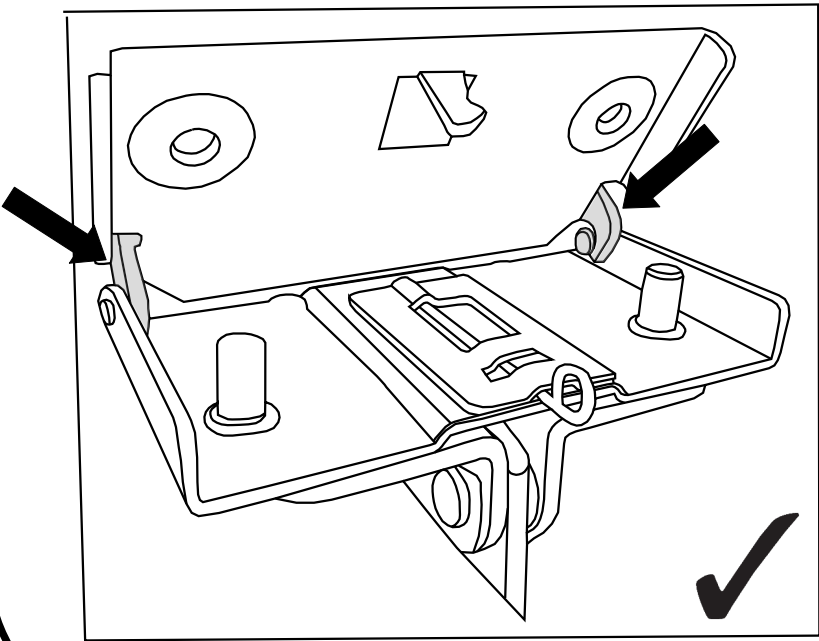

- A-1 A-2 B C-1 C-2
- D E-1 E-2 F-1 F-2

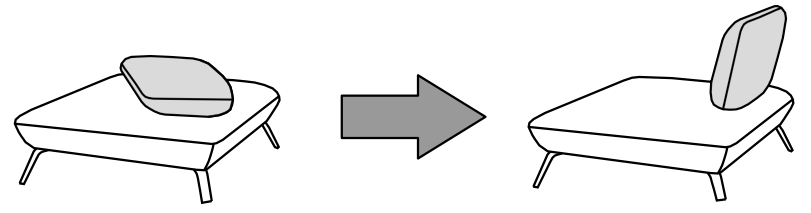

5

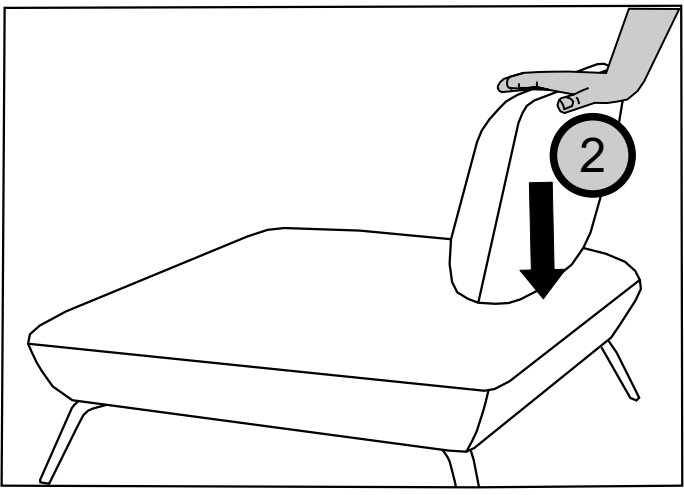
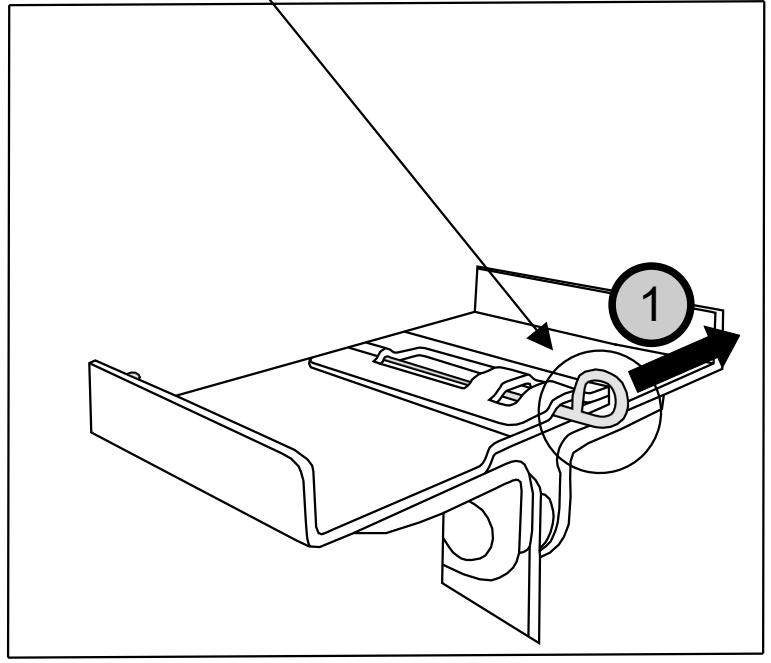
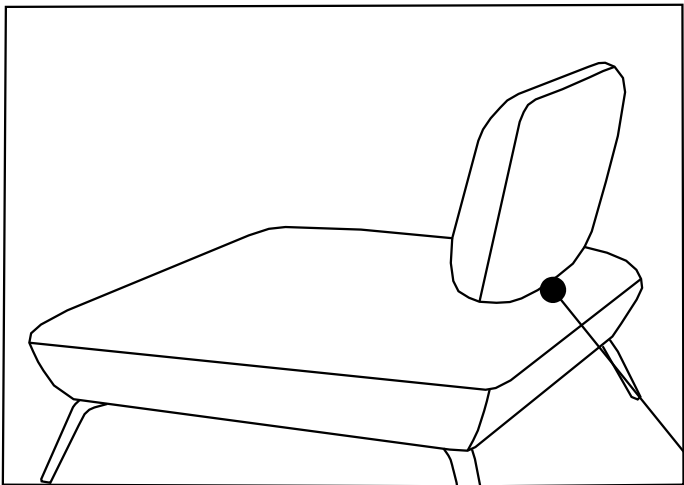

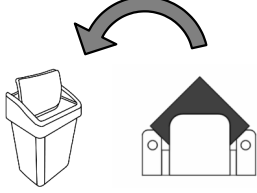

1

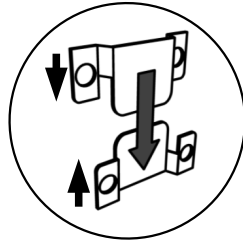
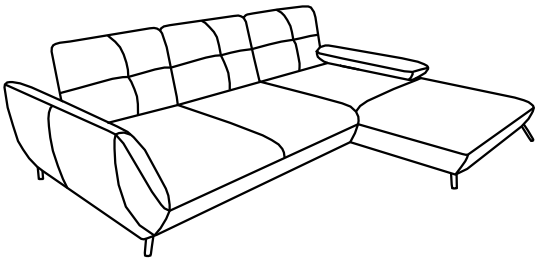

A-1

C-1

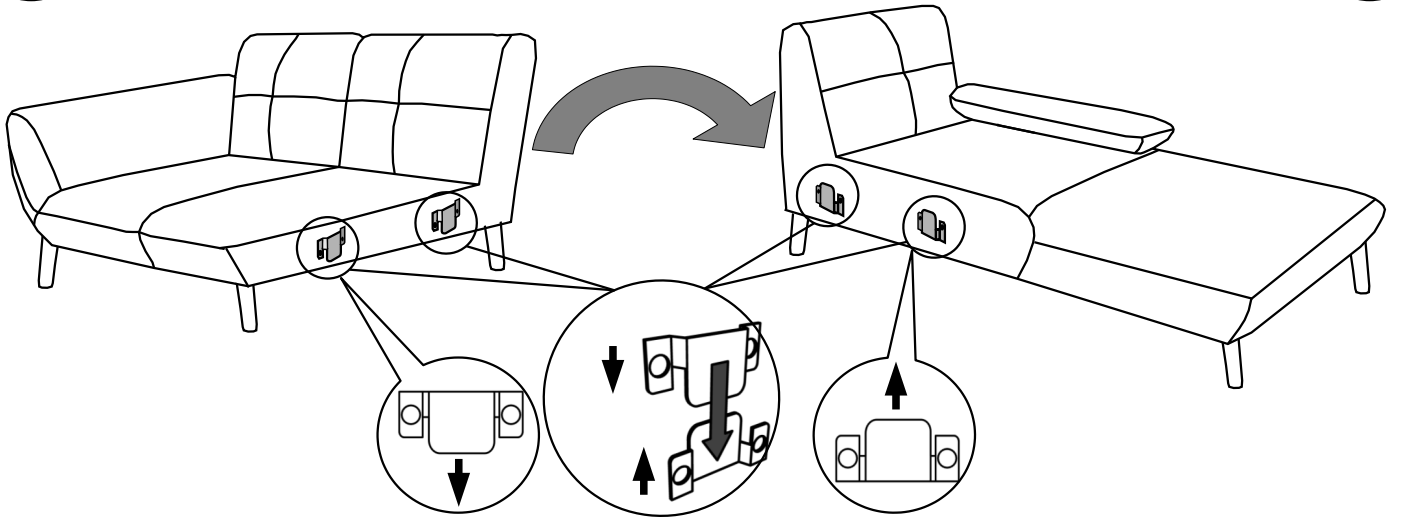

1

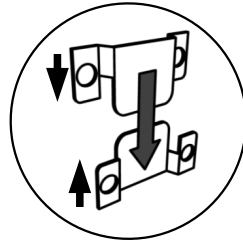
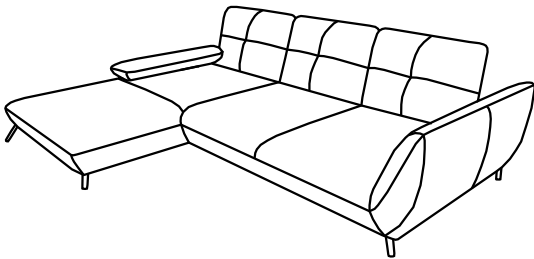

C-2

A-2

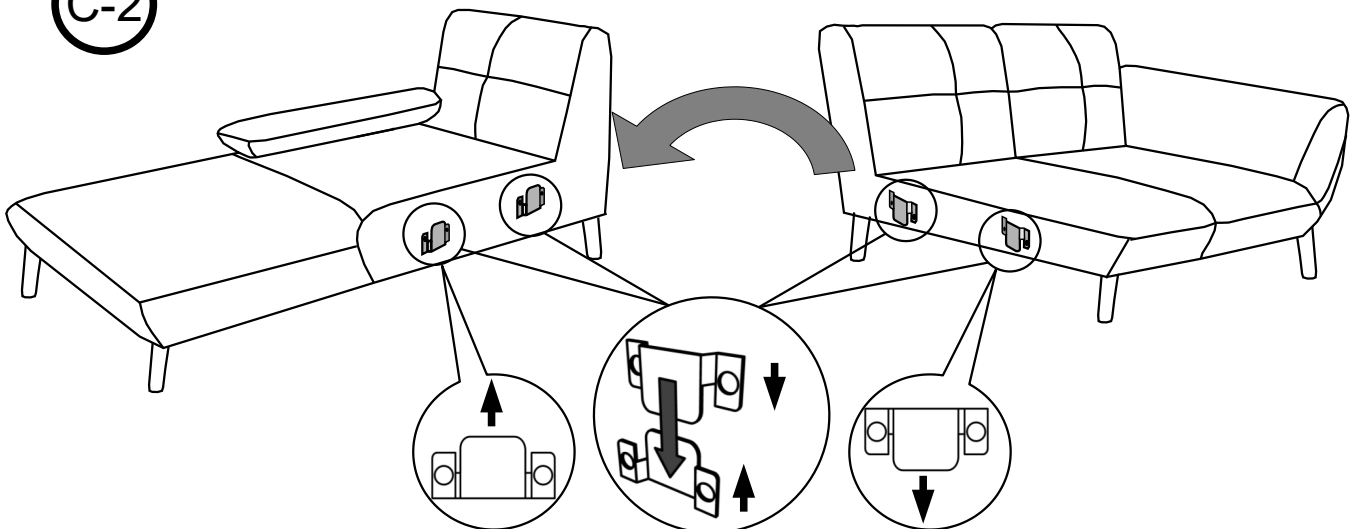

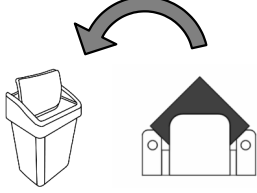

2

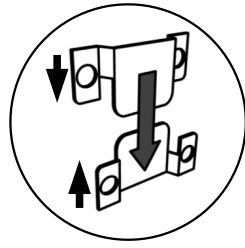
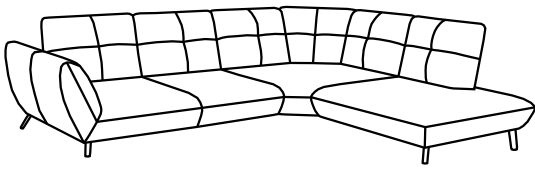

A-3

D

E-1

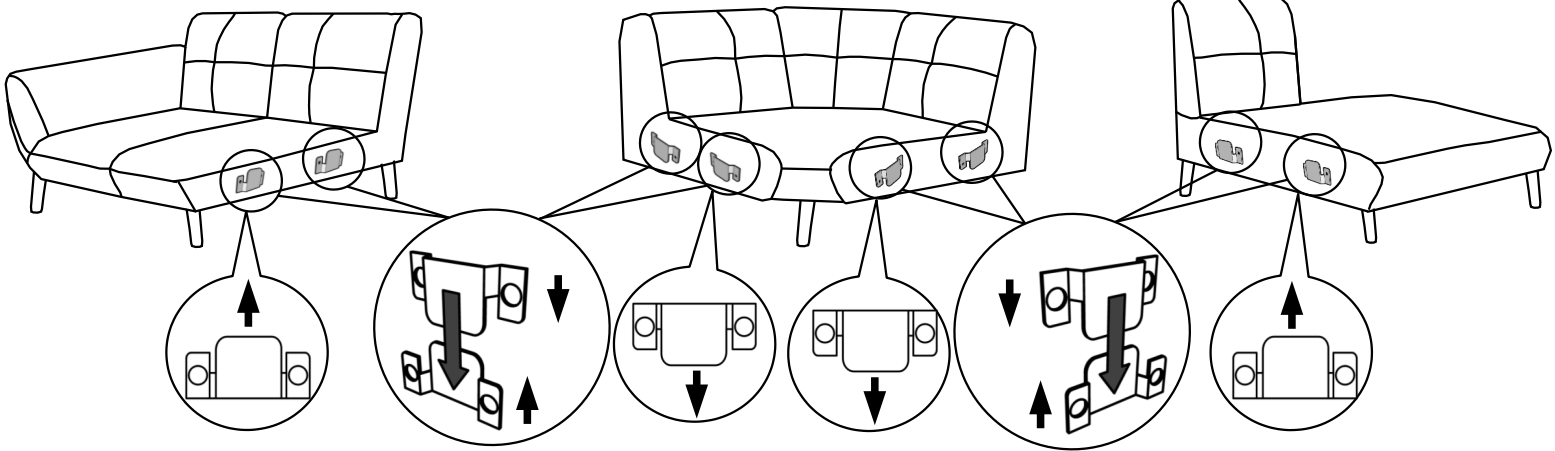

2

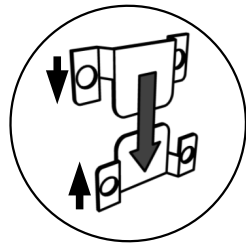
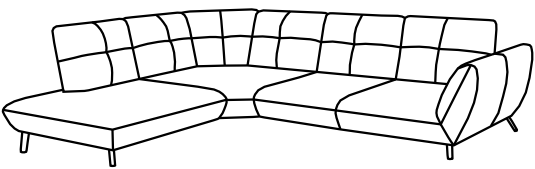

E-2

D

A-4

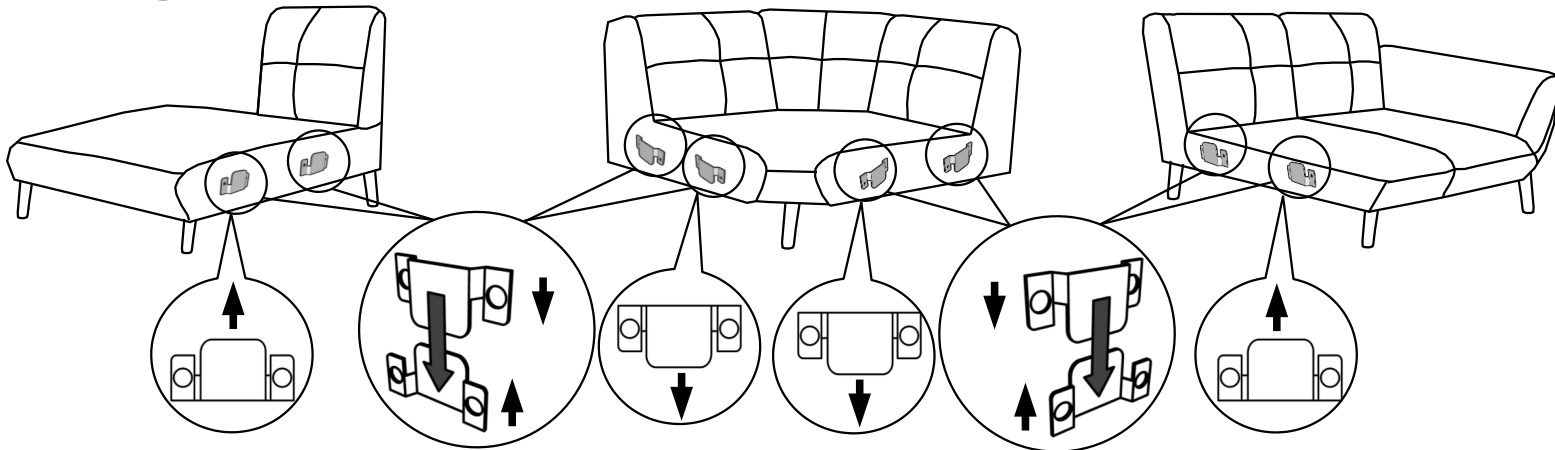

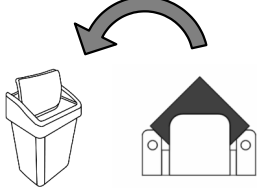

3

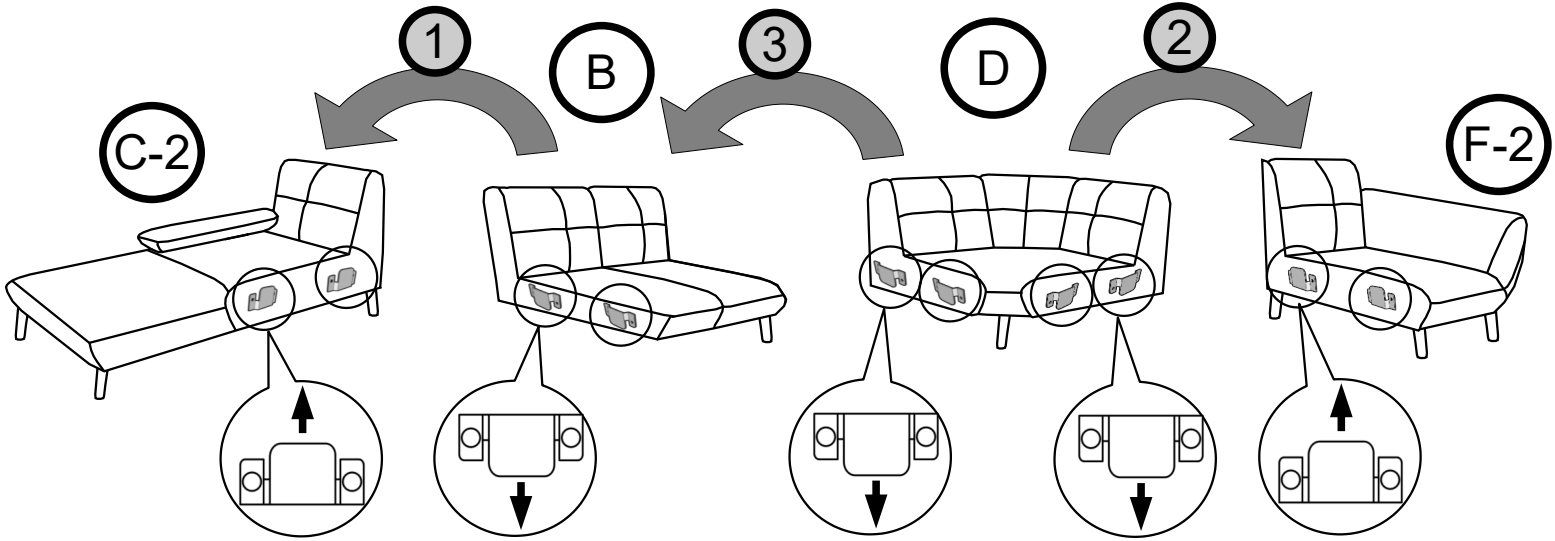
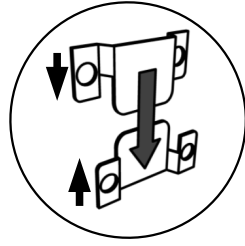
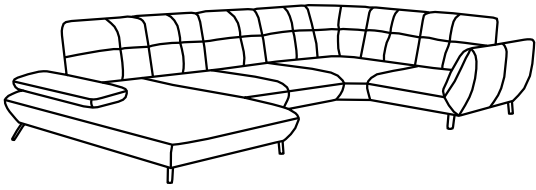

3

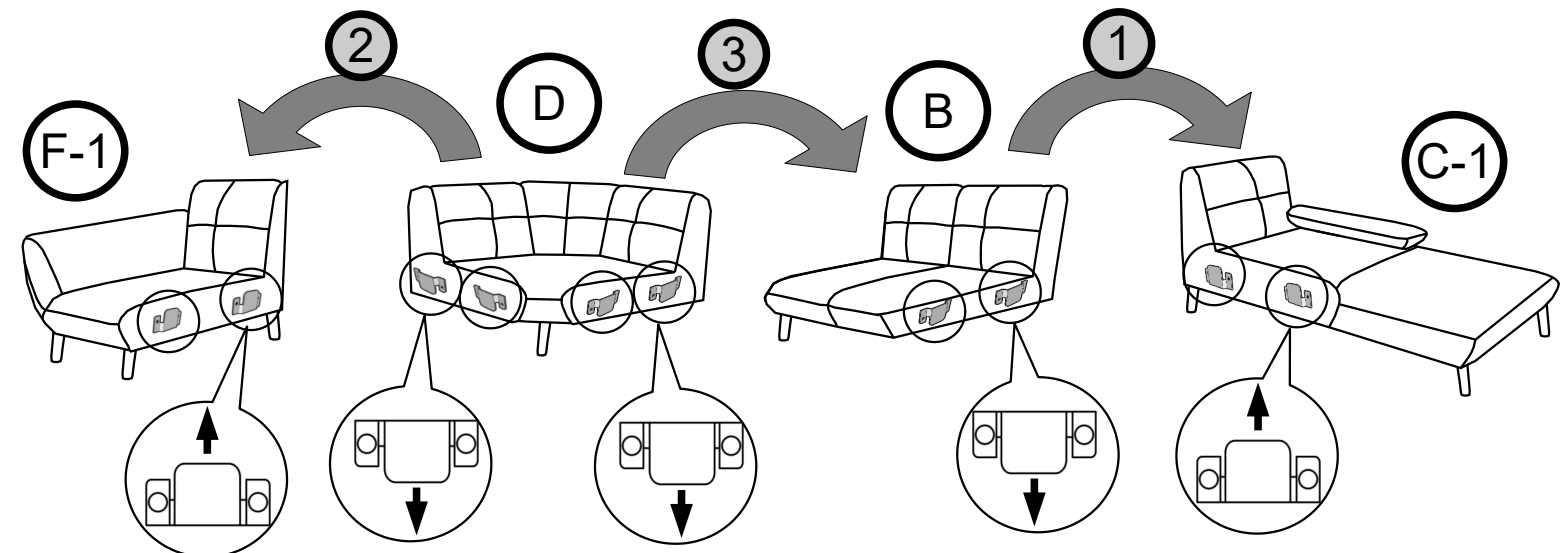
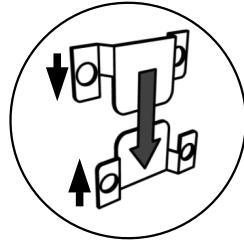
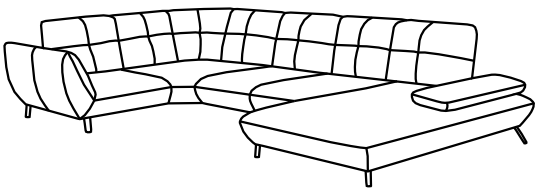

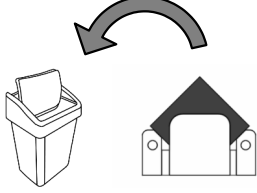

4

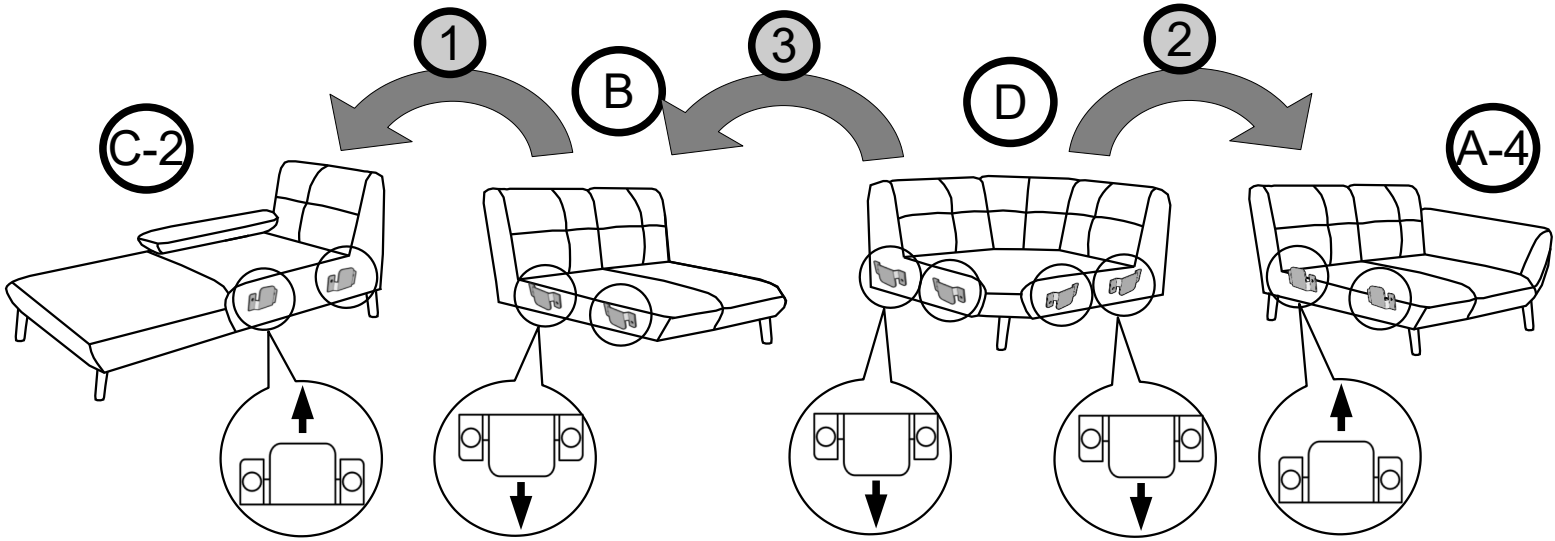
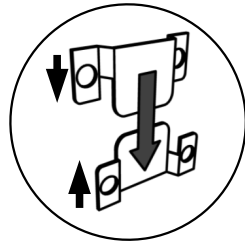
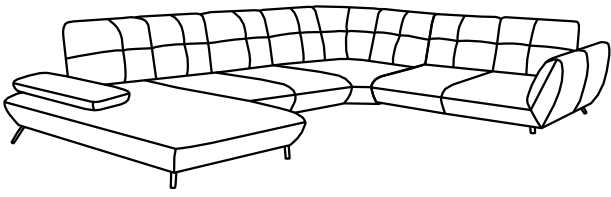

4

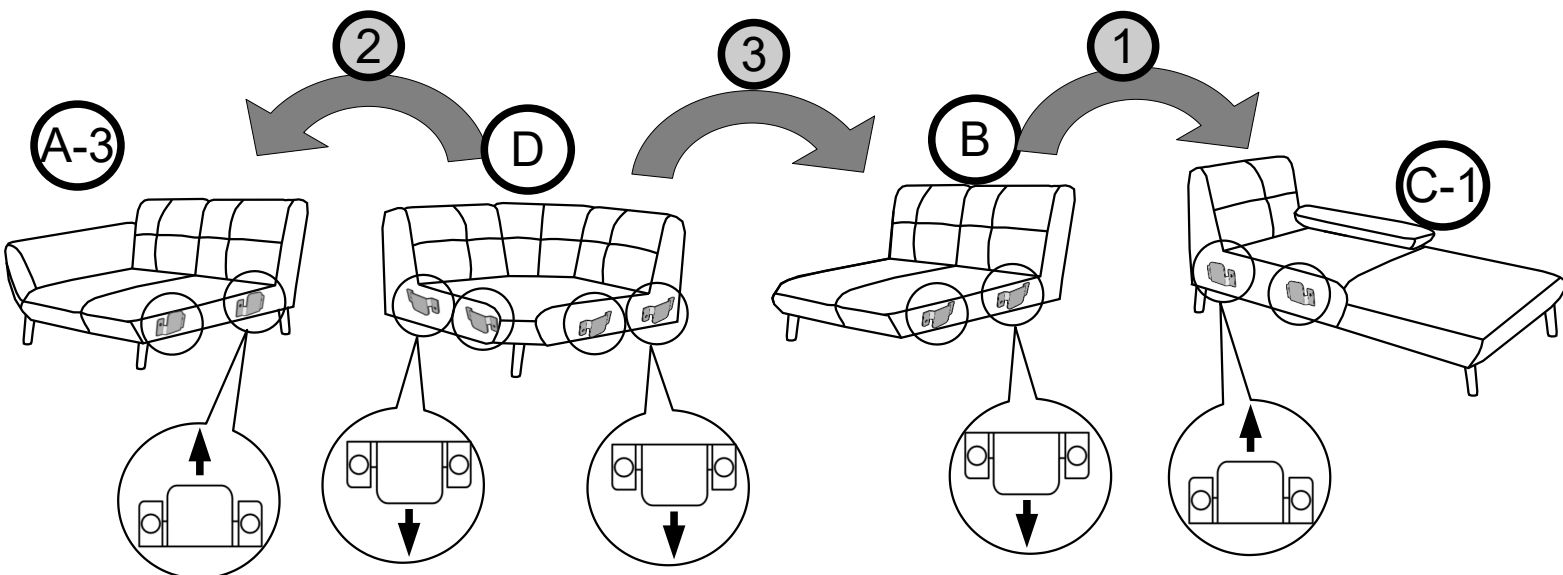
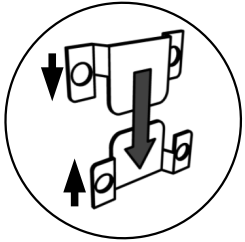
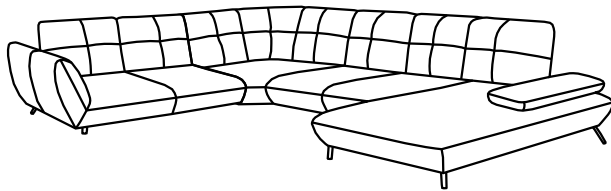

0037

1

2

3

4

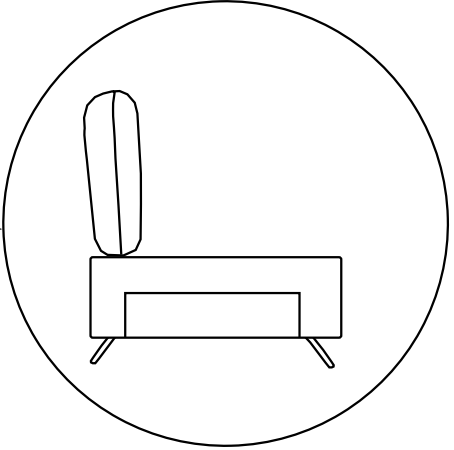
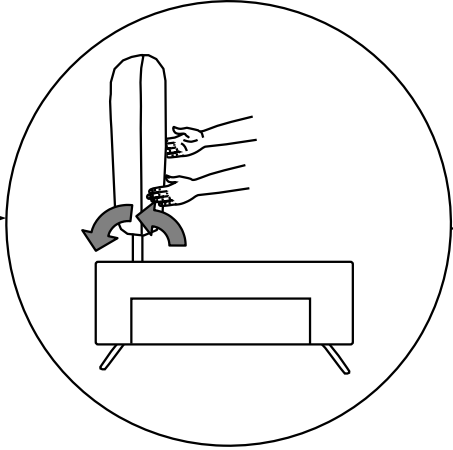
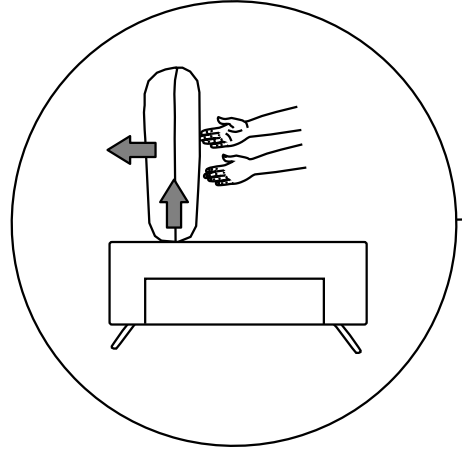
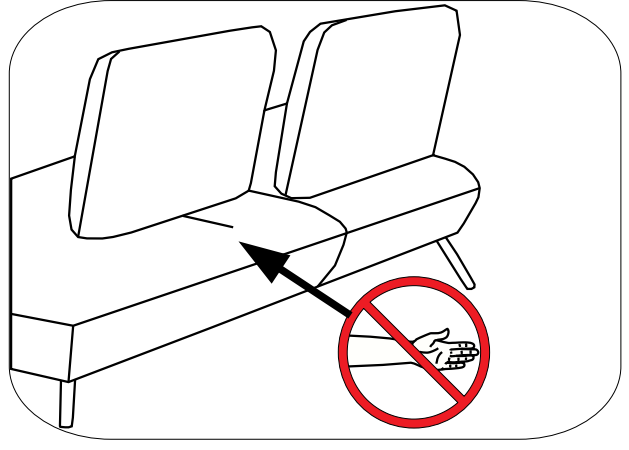
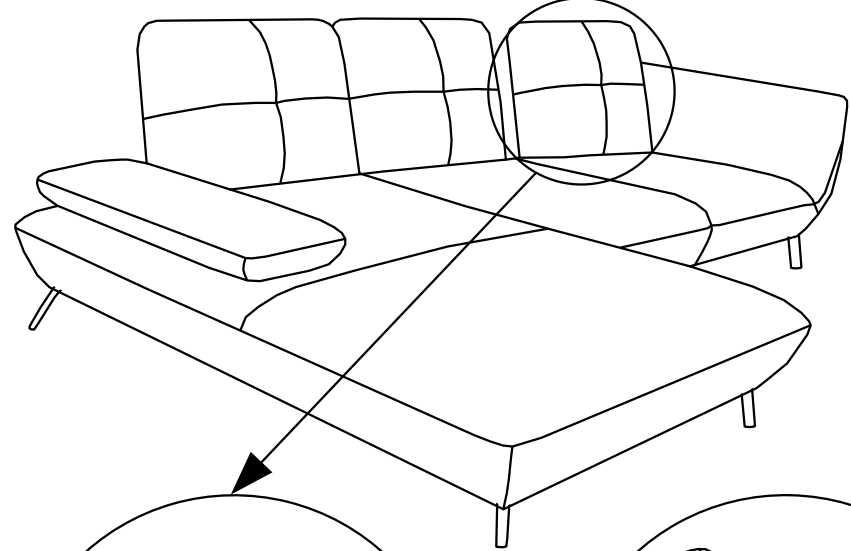
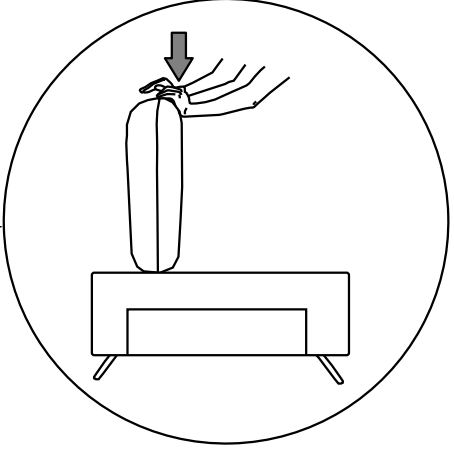
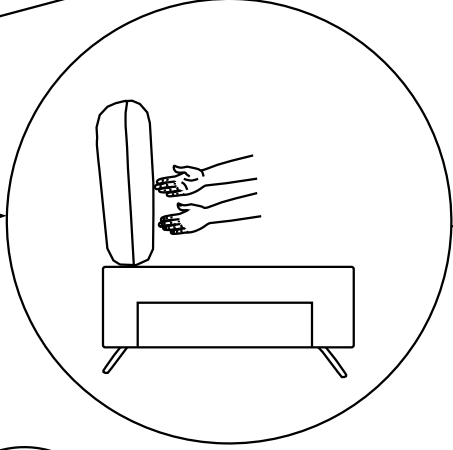
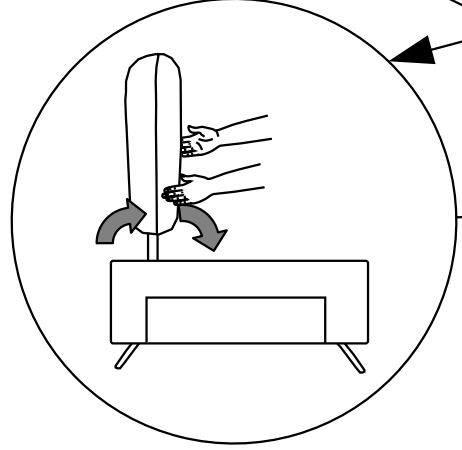
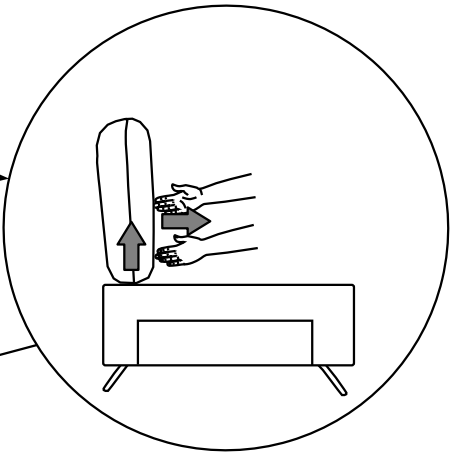
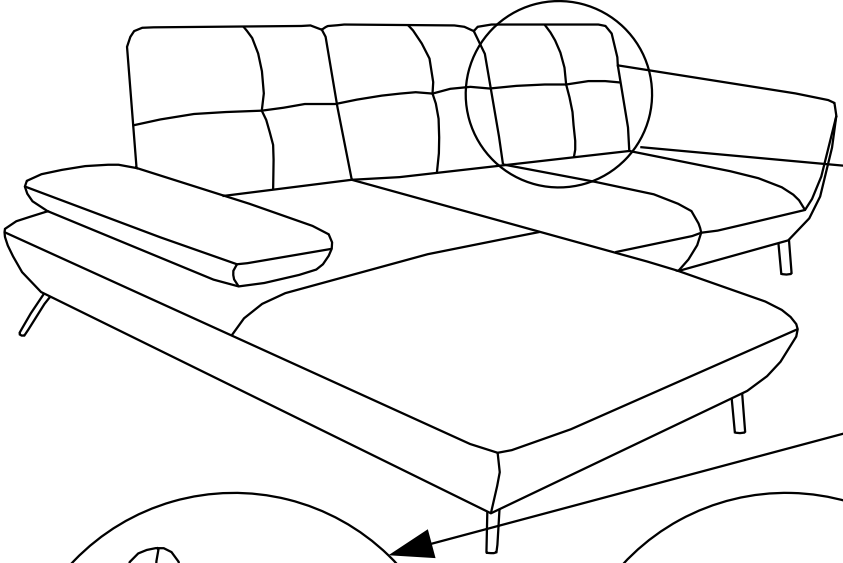

0090

A-1 A-2 A-3 A-4
C-1 C-2

