

# NATURE STUD COMPACT SIDEBOARD- 73813368

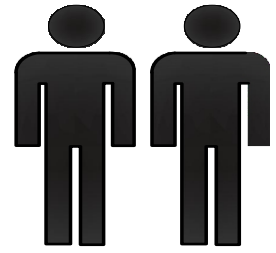
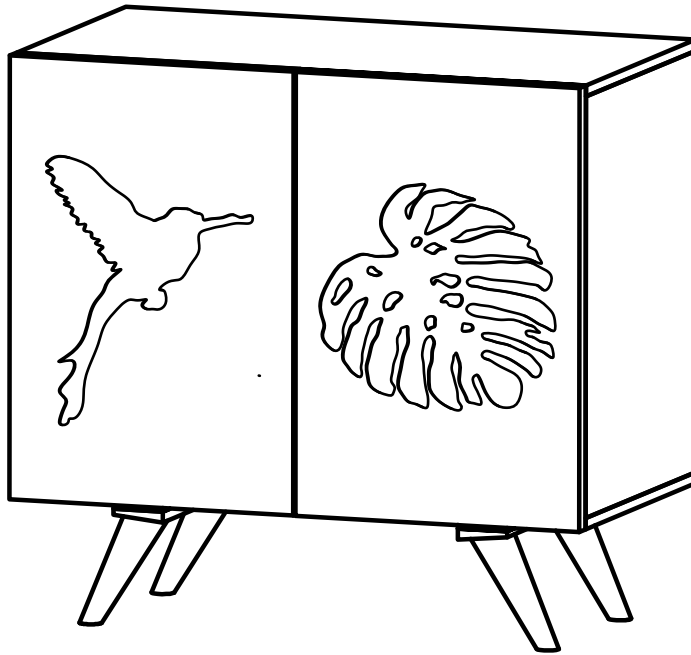

**(D)** Montageanleitung

**(GB)** Assembly instructions

**(NL)** Handleiding voor de montage

**(PL)** Instrukcja montażu

**(TR)** Montaj talimatı

**(RU)** Инструкция по монтажу

**(FR)** Notice de montage

**(IT)** Istruzioni di montaggio

**(CZ)** Montážní návod

**(SK)** Návod na montáž

**(HU)** Szerelési útmutató

**(RO)** Instrucțiuni de montaj



**(H1)** x 6



**(H2)** x 6



**(H3)** x 6

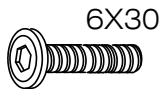

**(K1)** x 4

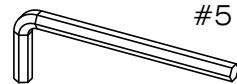

**(T1)** x 1



**(K2)** x 1

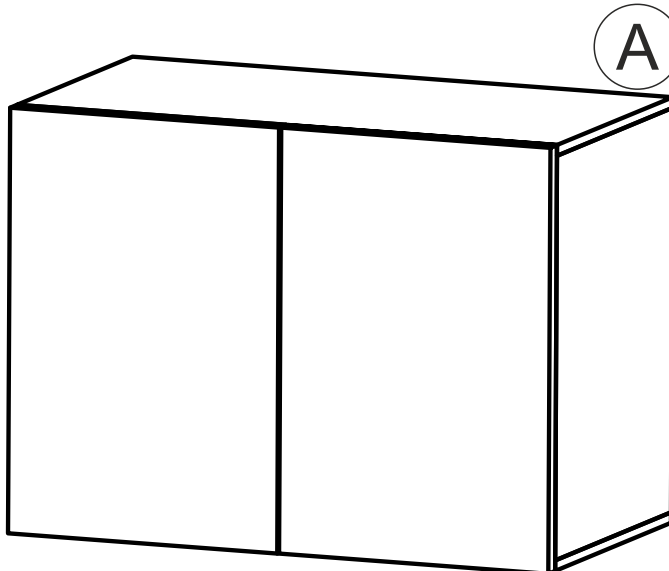

**(A)**

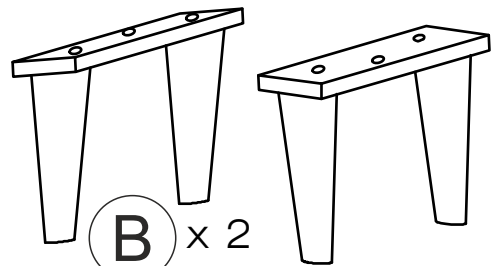

**(B)** x 2

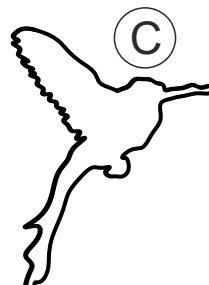

**(C)**



**(D)**

**Service • Assistenza • Dienstverlening • Serwis  
Servis • Szerviz • Сервисная служба**

Name • Nom • Nome • Naam  
Nazwa • Jméno • Názov • Név  
Denumire • Isim • Название

Nr. • No. • N° • Номер • C • Sz

Typ • Type • Tip • Típus • Tipo  
Тип

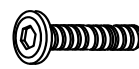
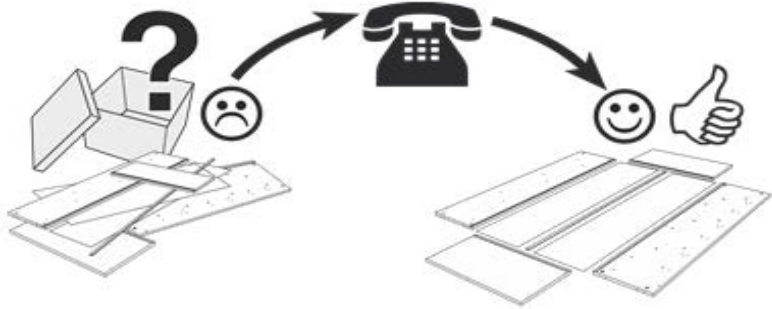
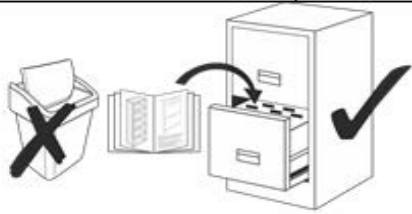

8X20

8X30

#5

H1

6 Pieces

H2



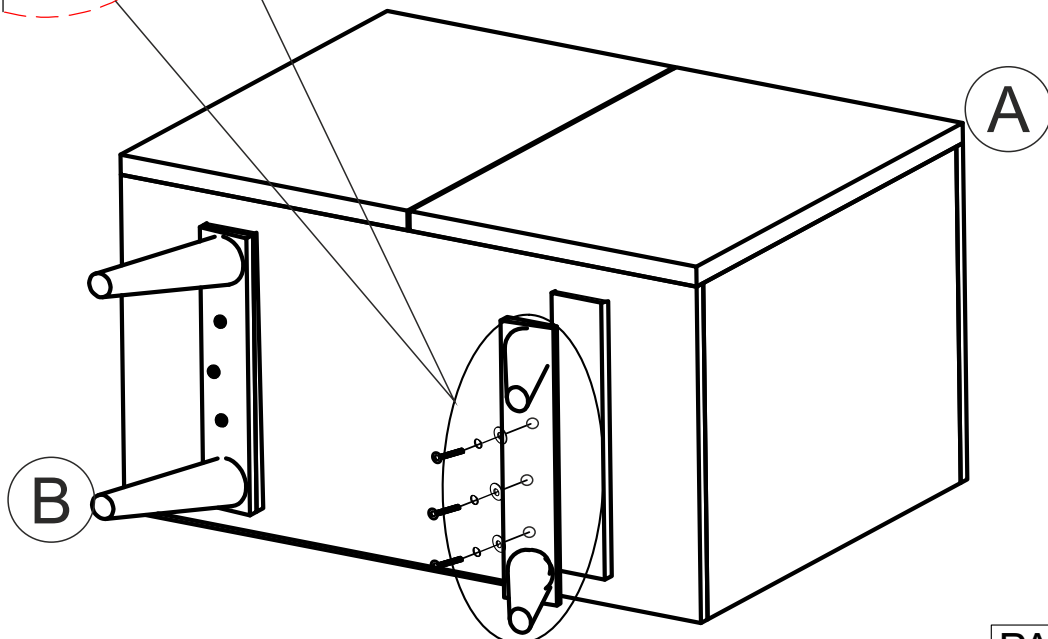
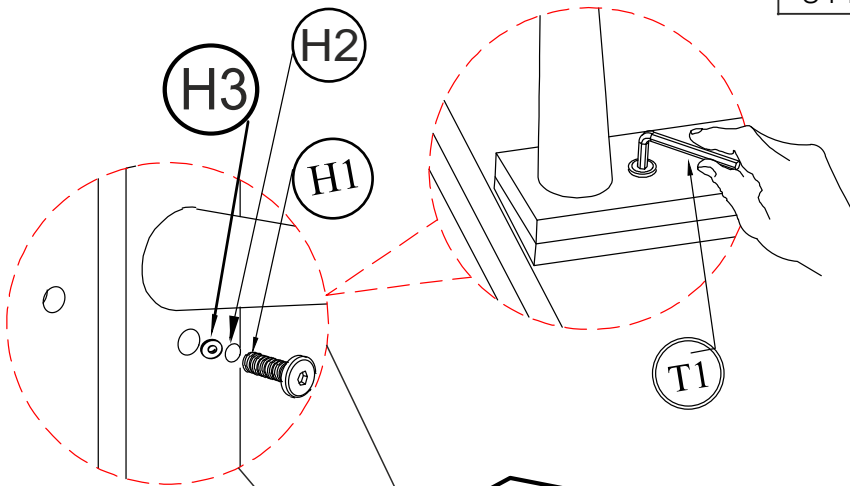

6 Piece

T1

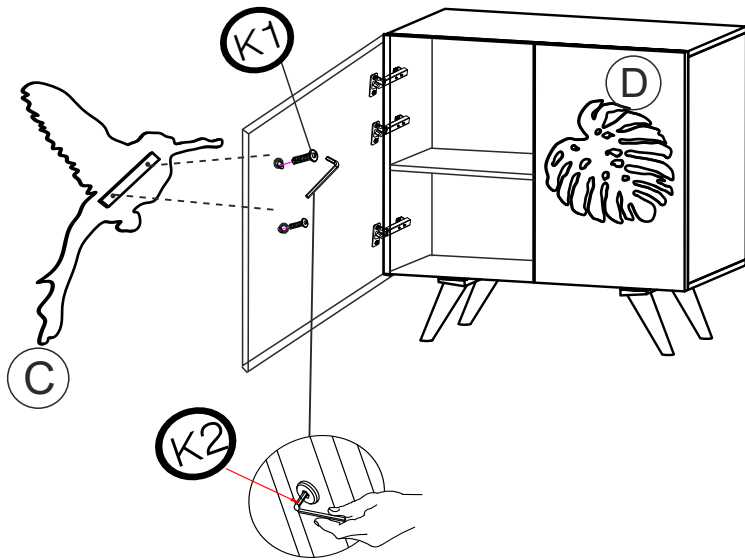
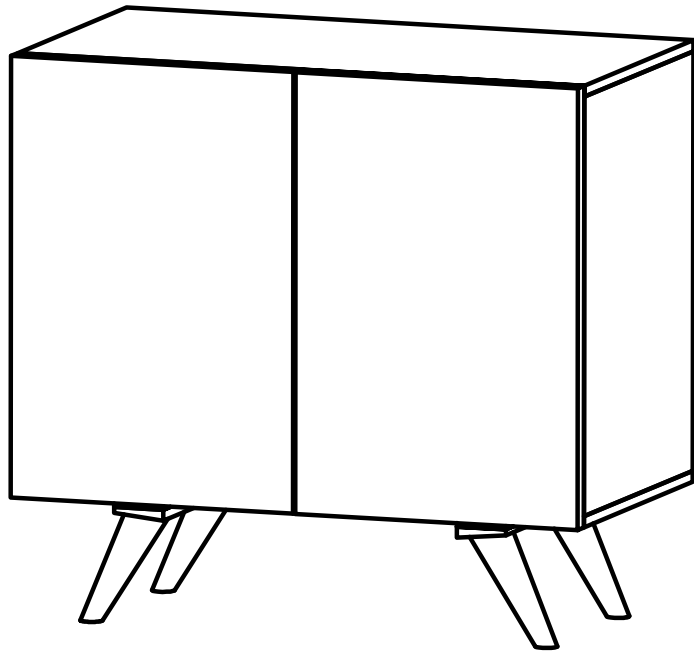
1 Piece





	
6X30	#4
 K1	 K2
4 Pieces	1 Piece

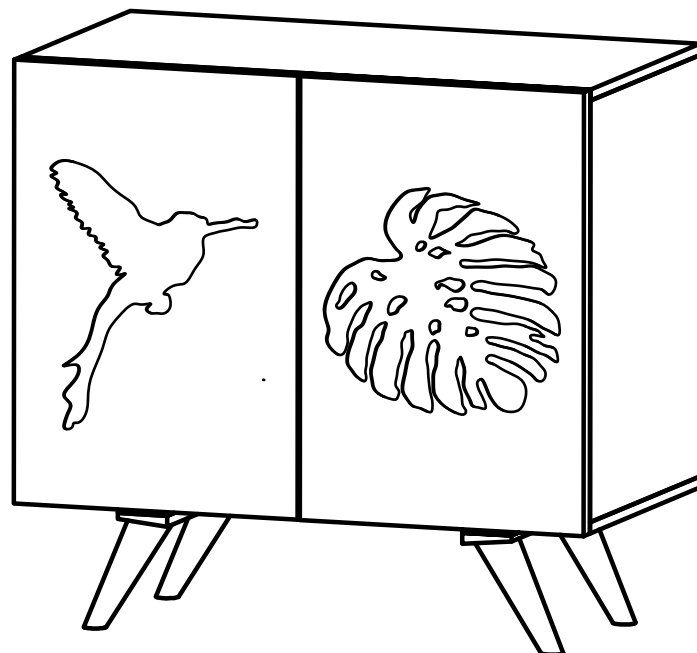



**Achtung • Attention • Attenzione • Oprelet • Uwaga • Pozor • Figyelem • Atenție •  
Dikkat • Вниманіе**



(D)	Wandbefestigung dient als Kippschutz – unbedingt anbringen! Bei einigen Wandtypen kann ein Spezialdübel erforderlich sein!
(GB)	The wall fastening serves to prevent tipping – be absolutely sure to mount it! For certain wall types, a special dowel may be necessary!
(NL)	Bevestiging aan de muur dient als kantelbescherming – zeker en vast bevestigen! Bij enkele muurtypen is een speciale plug misschien vereist!
(PL)	Mocowanie do ściany jest jednocześnie zabezpieczeniem przed przewróceniem – koniecznie zamontować! Do niektórych rodzajów ścian konieczne mogą być specjalne wkręty!
(TR)	Duvardaki sabitleme, devrilmeye karşı bir emniyet tedbiridir ve mutlaka monte edilmelidir! Bazı duvar tiplerinde bunun için özel bir dübel gerekli olabilir!
(RU)	Обязательно установите крепление на стене во избежание опрокидывания! Для некоторых типов стен может потребоваться специальный дюбель!
(FR)	La fixation murale sert de protection contre le basculement – à installer impérativement ! Pour certains types de murs il faut des chevilles spéciales !
(IT)	Il fissaggio alla parete serve da protezione anti-ribaltamento – attaccarla assolutamente! Per alcune strutture di parete può essere necessario un tassello speciale!
(CZ)	Montáž na stěnu slouží jako ochrana proti převrnutí – bezpodmínečně umístěte! U některých typů stěn může být zapotřebí speciální hmoždinka!
(SK)	Upevnenie na stenu slúži ako ochrana proti prevráteniu – bezpodmienečne použite! Pre niektoré druhy stien môže byť potrebná špeciálna hmoždinka!
(HU)	A terméket a falhoz kel rögzíténi, különben az felborulhat! Egyes faltípusoknál speciális tiplít kell használni!
(RO)	Sistemul de fixare la perete servește ca protecție la răsturnarede montat obligatoriu! Pentru unele tipuri de pereți este posibil să fie necesar un diblu special!

