

Oregon

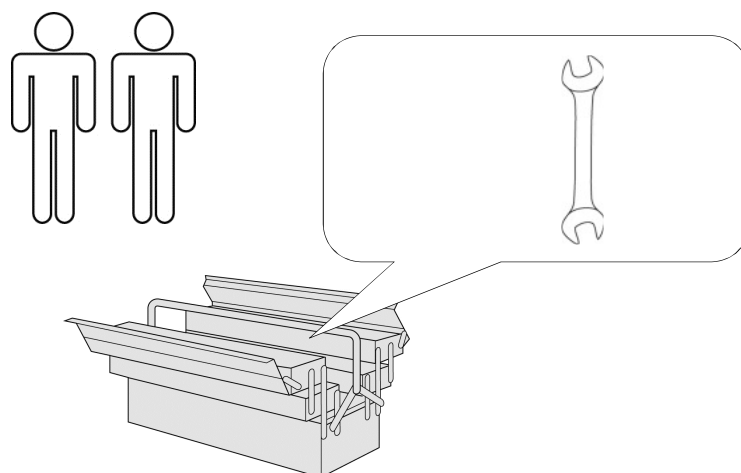







- | | |
|----------------------------------|---------------------------------------|
| D Montageanleitung | GB Assembly instructions |
| FR Notice de montage | NL Handleiding voor de montage |
| CZ Montážní návod | IT Istruzioni di montaggio |
| RO Instrucțiuni de montaj | RU инструкция по сборке |
| PL Instrukcja montażu | SK Návod na montáž |
| HU Szerelési útmutató | TR Montaj talimatı |

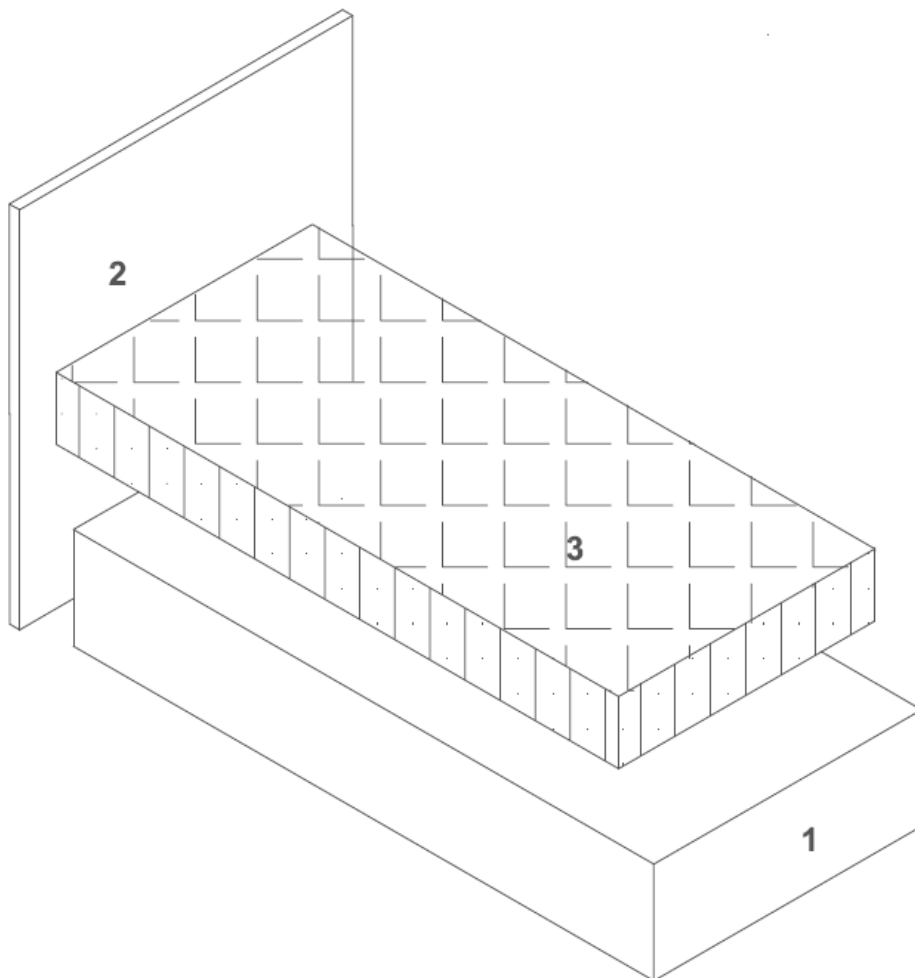
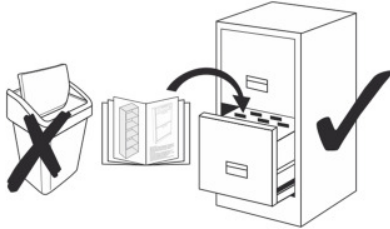
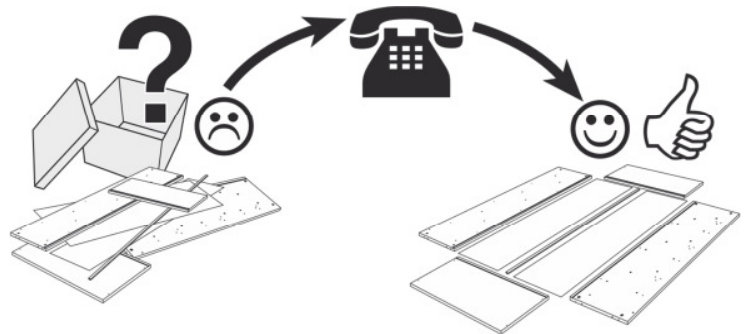

Service • Assistenza • Dienstverlening • Serwis Servis • Szerviz • Сервисная служба

Name • Nom • Nome • Naam Nazwa • Jméno • Názov • Név Denumire • İsim • Название	Orgon EB
Nr. • No. • N° • Номер • Č • Sz	SH50
Typ • Type • Tip • Típus • Tipo Тип	BS G







A	B	C	D	E	F
					
4x	8x 8x40	2x	2x 8x50	4x 8x60	4x M8

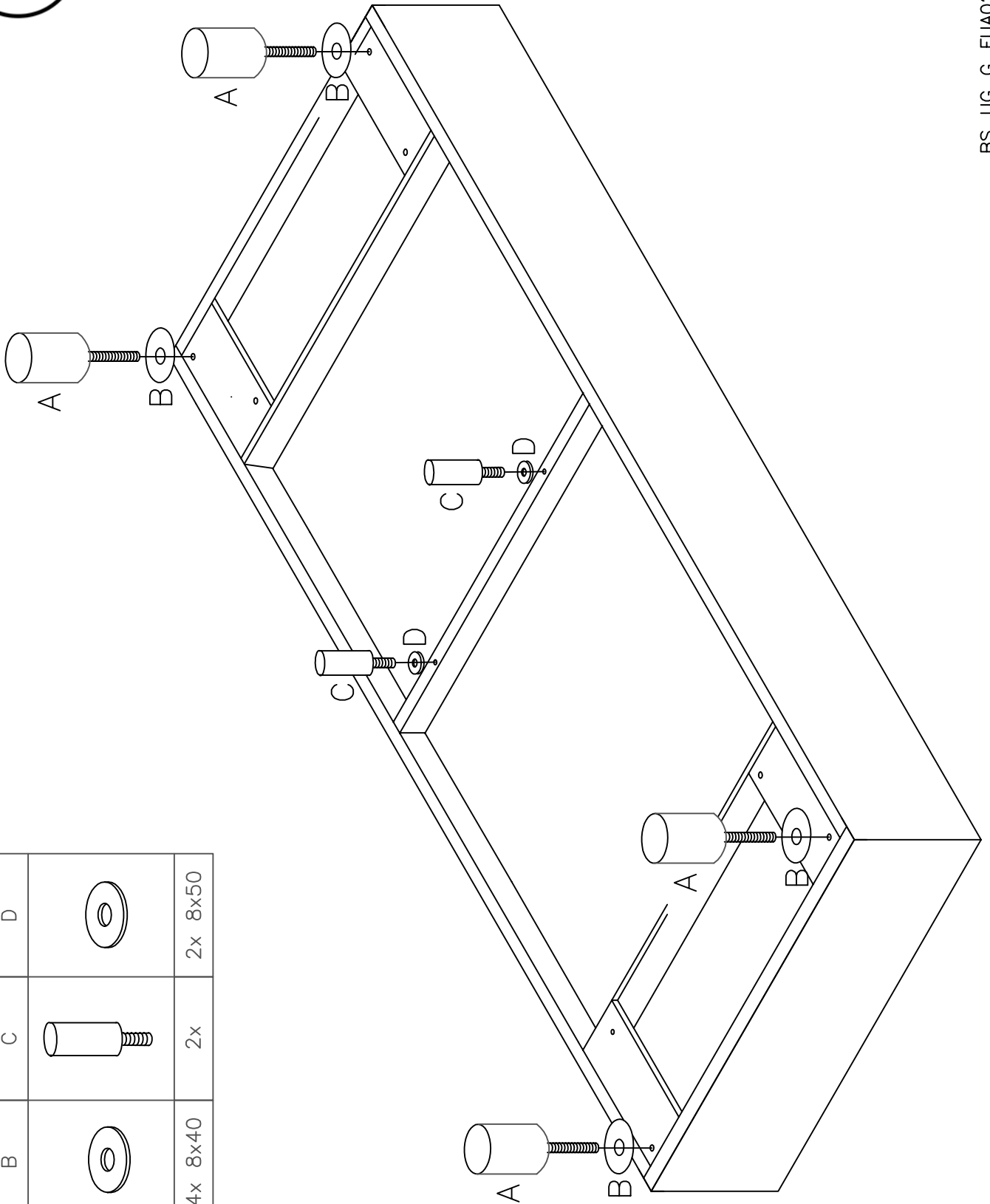

A		4x
B		4x 8x40
C		2x
D		2x 8x50

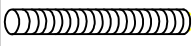



E		4x 8x60	4x 8x40	4x M8	<p>Achtung! Schrauben nicht überdrehen</p> <p>FR Attention! Ne serrez pas trop</p> <p>CZ Dávej Pozor! Nepřetahujte</p> <p>RO Ai Grija! Nu strângeți</p> <p>PL Uwaga! Nie dokręcać zbyt mocno</p> <p>HU Vigyázz! Ne húzza túl</p> <p>GB Watch Out! Do not over tighten</p> <p>NL Let Op! Niet te vast</p> <p>IT Attento! Non stringere</p> <p>RU Осторожно! Не затягивайте</p> <p>SK Dávaj Pozor! Nepretahujte</p> <p>TR Dikkat! Üzerinde sıkmayın</p>
F		4x M8	4x 8x40	4x M8	
B		4x 8x40	4x 8x40	4x M8	
E		4x 8x60	4x 8x40	4x M8	

