

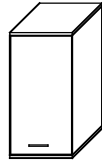

330/925

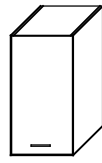

318/359/91_



3_ _ -013030

9_ _ -013030

MOT-NZ0884S1 A4

Datum 16/03/18

T1

Bitte unbedingt ausfüllen!

Name _____

Strasse _____

PLZ _____ Ort _____

Tel. _____

T2

Sehr geehrte Kunden,
wir freuen uns, dass Sie sich für ein Produkt aus dem Hause Pelipal entschieden haben. Sollte es trotz aller Bemühungen unsererseits, Ihnen ein qualitativ hochwertiges Möbelstück zu liefern, zu Fehlteilen kommen, schicken Sie bitte dieses ausgefüllte Blatt an

Fax.: +49 3443/434350

E-Mail: ersatzteile@pelipal.de

Bitte beachten Sie, dass Bauteile über 800mm Länge und 350mm Breite direkt bei Ihrem Möbelhändler zu beanstanden sind. Zur Reklamationsbearbeitung ist es unbedingt erforderlich **die Artikelnummer des Schrankes**, welche auf dem Etikett ersichtlich ist und den Markt, wo das Möbel erworben wurde anzugeben. Außerdem tragen Sie unten bitte die benötigte Stückzahl ein. Viel Spaß mit Ihrem neuen Badmöbel!

Ihr Pelipal Team

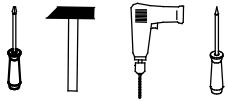

T3

Für den Zusammenbau sind 2 Personen erforderlich.

T4

Montage-Richtzeit 3 Stunden

330-013030

318-013030

359-013030

91_ -013030

925-013030

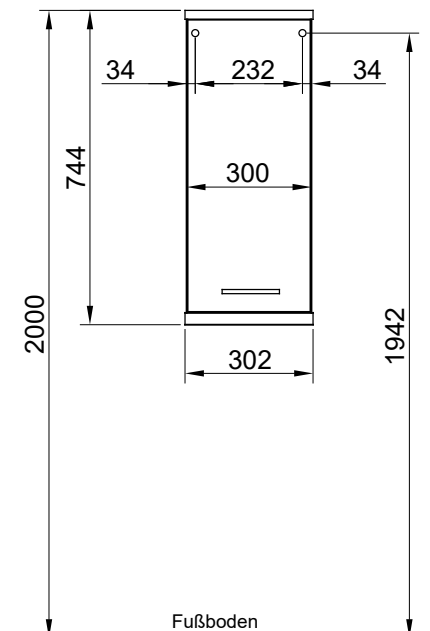



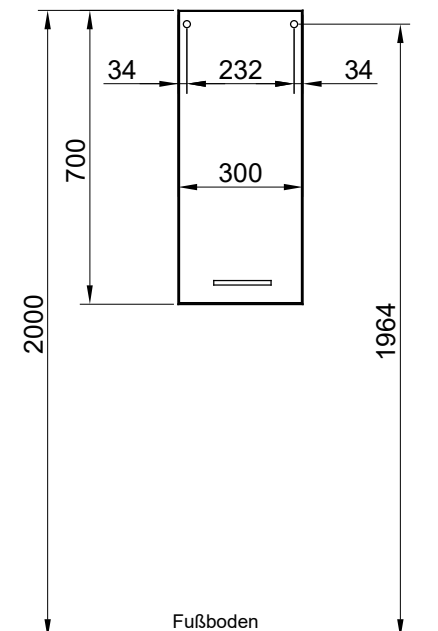



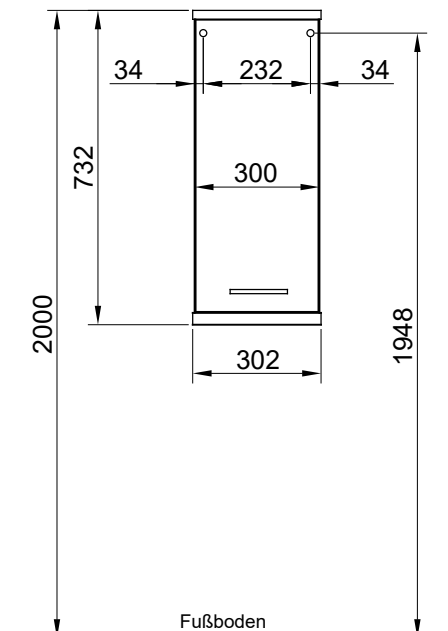



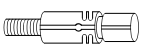

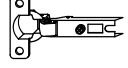
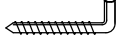

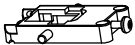
Die Maßangabe der Höhe ist nicht bindend!

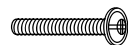

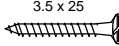

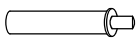
Die Maßangabe der Höhe ist nicht bindend!

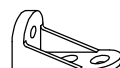
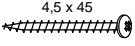

Die Maßangabe der Höhe ist nicht bindend!

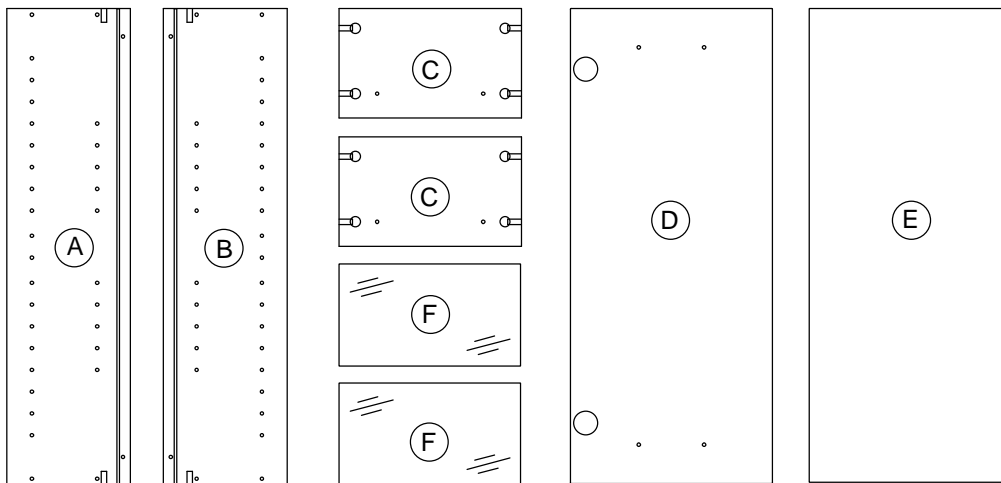
8 x a  DUEB-SMD-000005	Stück	8 x b  EXZENTER-000015	Stück	2 x c  ZPL-003X004	Stück	2 x d  TBD-35-115X00	Stück	MOT-NZ0884S2 A4 Datum 16/03/18	
2 x e  AUF-001-000020	Stück	8 x f  TRAE-001-000020	Stück	2 x g  AUF-001-000060	Stück	1 x h  Griff	Stück	2 x j 	Stück
6 x k  SCH-SPA-035X015	Stück	10 x l  NAGEL-025X001	Stück	4 x m  SCH-SPA-035X025	Stück	2 x n  ADK-__1-005X008	Stück	1 x o  TUER-DAEM-000010	Stück
1 x p  TUER-ADA-000010	Stück	1 x r  VBD-000020	Stück	1 x s  SCH-RDK-045X045	Stück	1 x t  SCH-RDK-040X015	Stück	2 x u  ADK-AL1-005X008	Stück

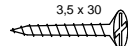
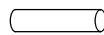
							330-013030 	
							925-013030 	
							4 x v	Stück
							 SCH-SPA-035X030	
							4 x w	Stück
							 TRAE-005-000010	

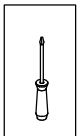
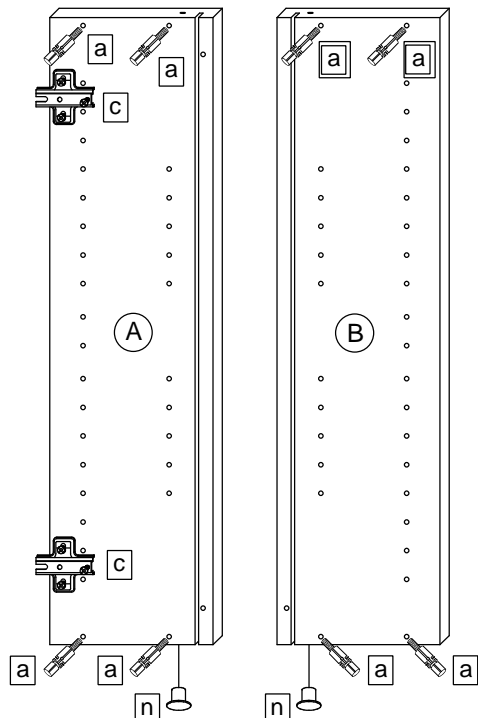
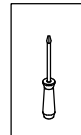
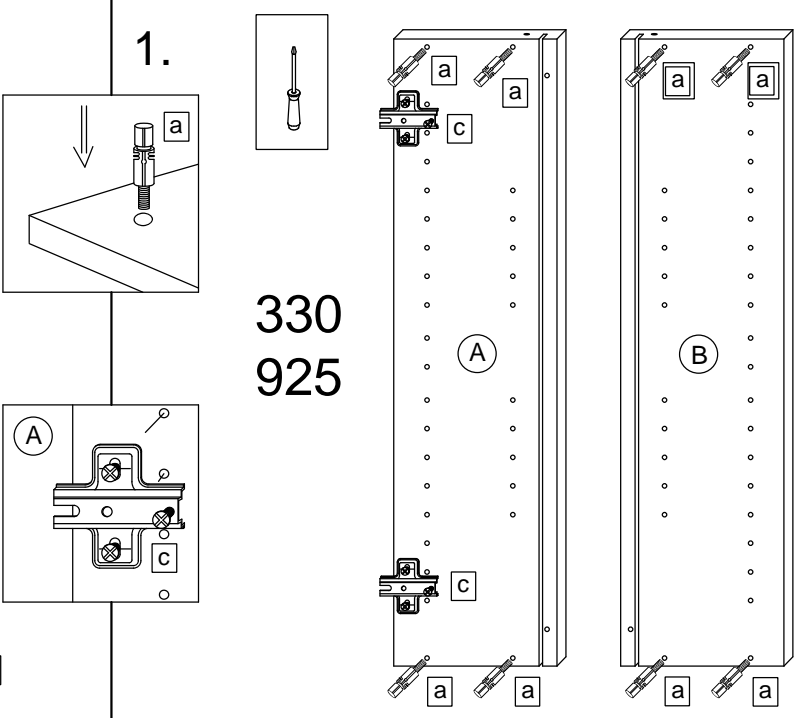
1.  318 359 91_ 	1.  330 925 
--	---

2. 318
 359
 91_

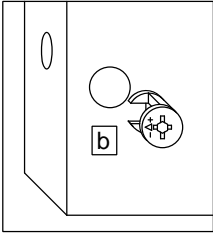
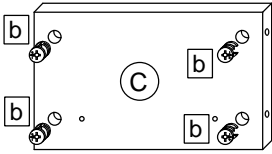
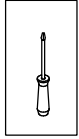

2. 330
 925

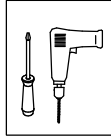

2.1

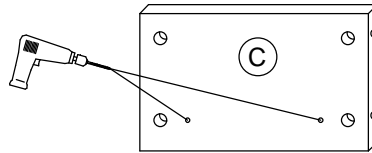
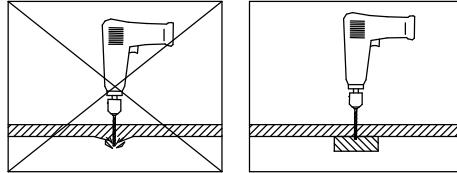

2.2

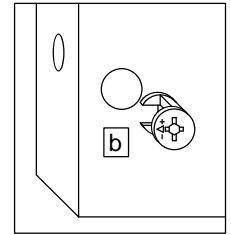
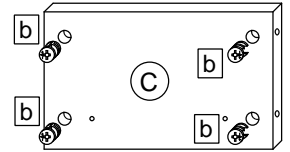

3.

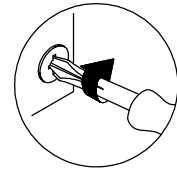
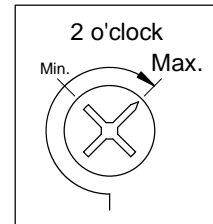
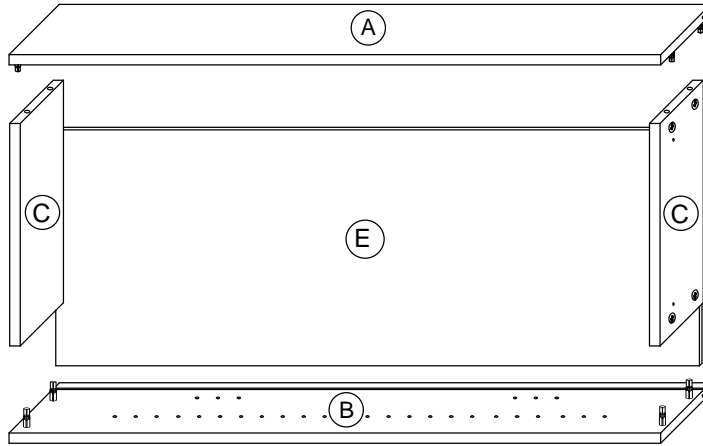

4. 5 x l

5.

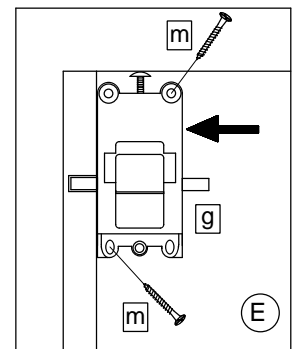
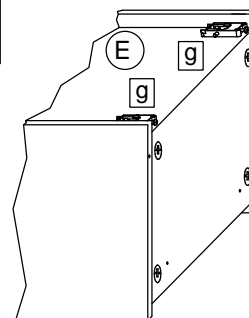

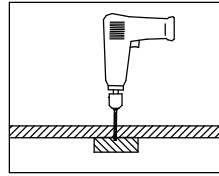
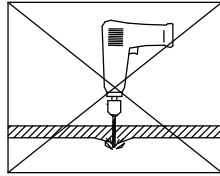
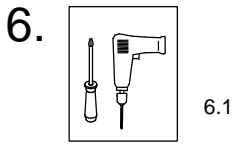

330
925

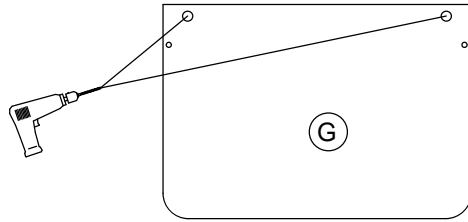

6.2

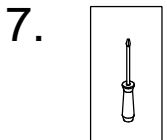
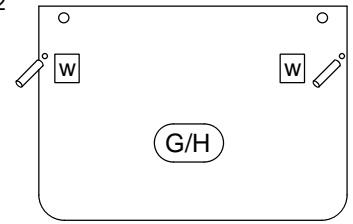

330
925

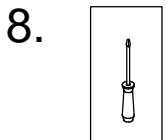
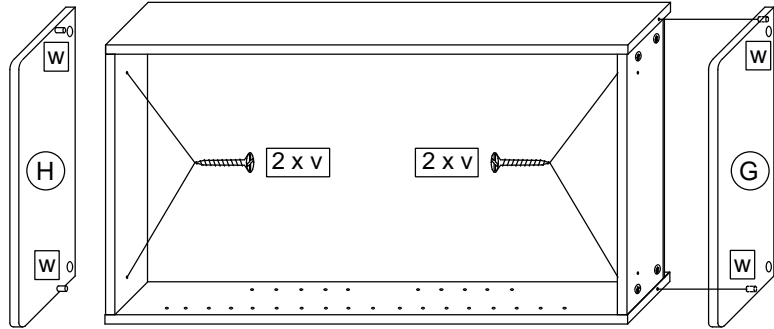

T9 Lassen Sie den Schrank nur durch fachkundige Personen mit für die Wand geeignetem Montagematerialien montieren.

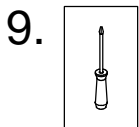
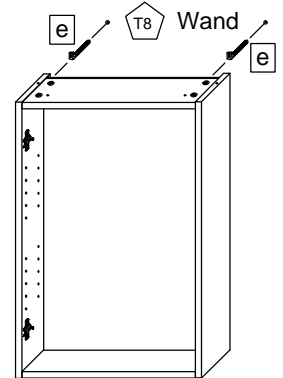
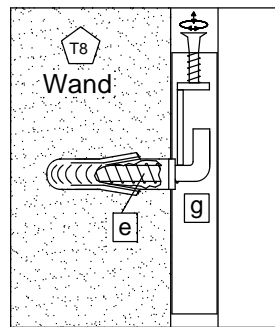

318
359
91_

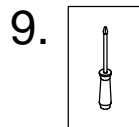
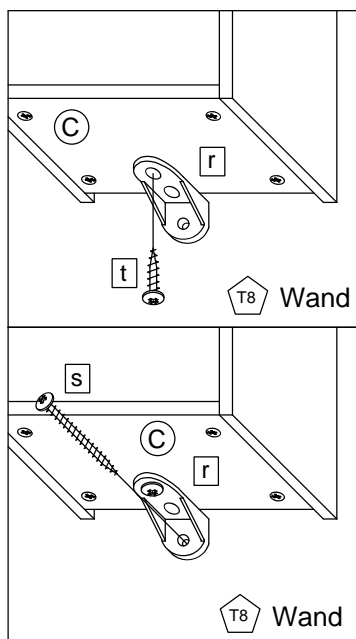

330
925

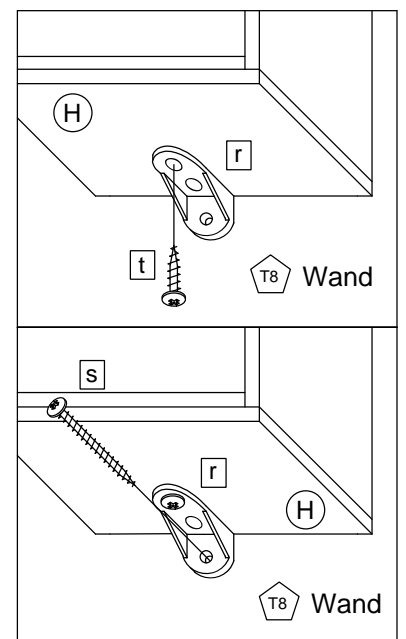

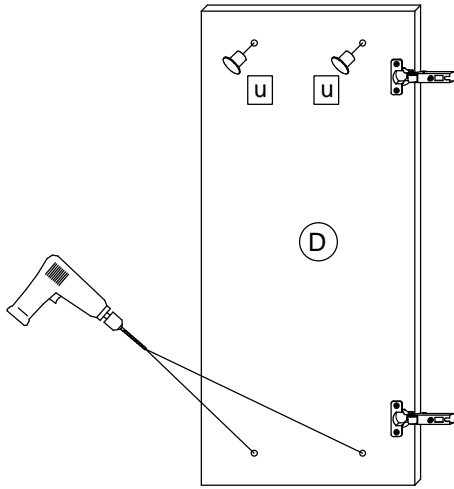
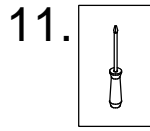
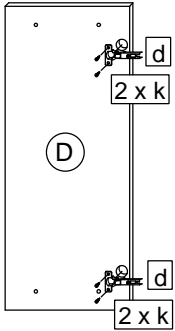
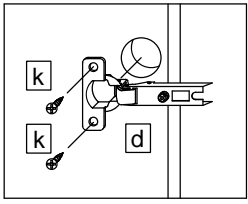
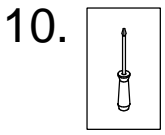

11.1

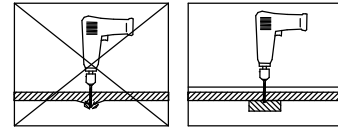

11.2

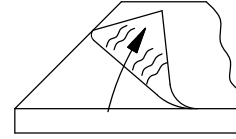

Bei Hochglanz-Fronten bitte erst die Schutzfolie entfernen und dann den Griff montieren!

11.3

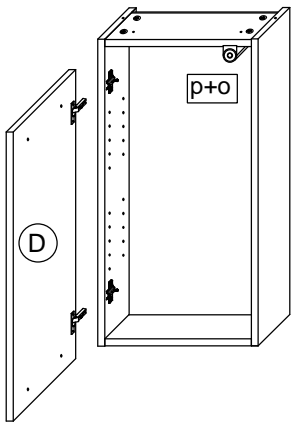
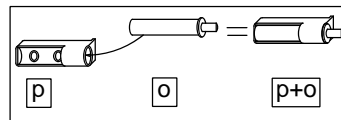
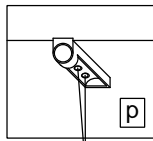
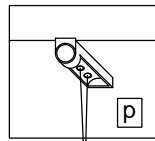
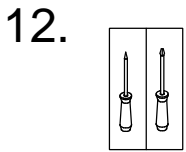
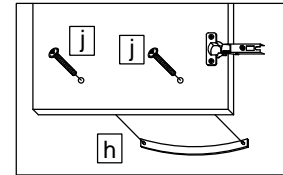

2 x k
 (3,5x15)



Bei Türmontage das Scharnier einhängen, bis Anschlag öffnen und anschließend festschrauben.

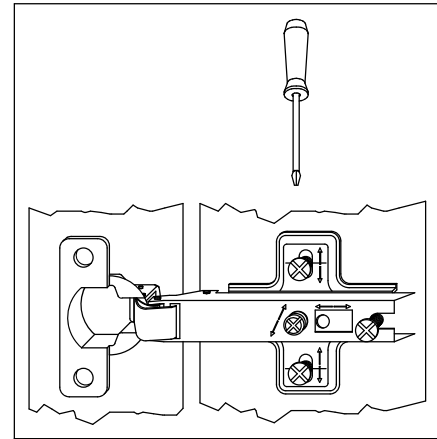
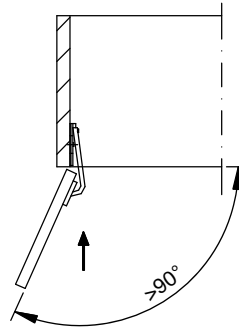

13.

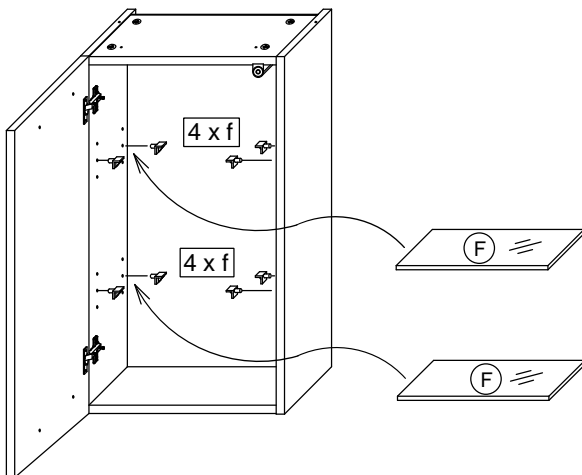

Das Möbel bitte nur mit einem feuchten Tuch reinigen.