

# Giselle

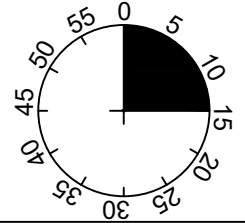

1

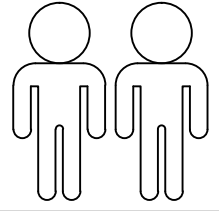
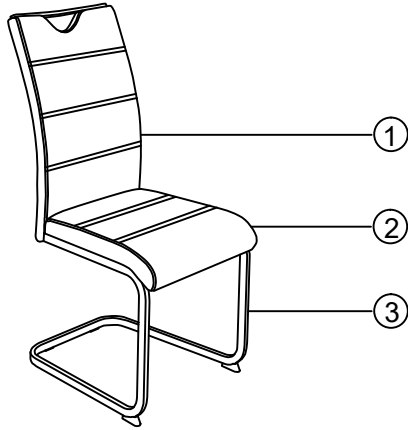
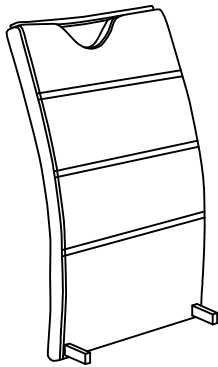

2

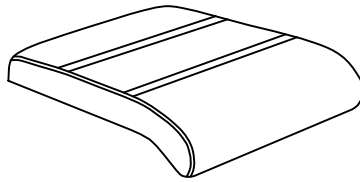

3

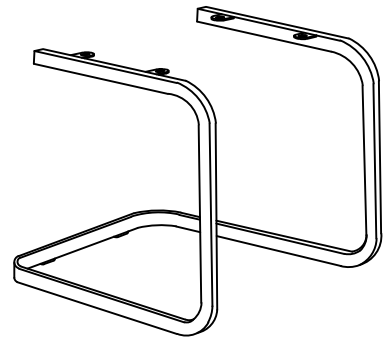

1	1x
2	1x
3	1x

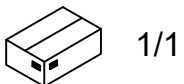

A	M6X20	B	M6X12	C	Ø18xØ6x1.5	D	4MM	E	M4x25	F	
	4x		4x		4x		1x		4x		2x

**I.**

**1**

E M4x25  
4x

F  
2x

100%

**2**

B M6x12  
4x

D 4MM  
1x

75%

**3**

A M6x20  
4x

C Ø18xØ6x1.5  
4x

D 4MM  
1x

75%

**4**

D 4MM  
1x

100%



**LE TRI  
+ FACILE**



Séparez les éléments avant de trier