

SLIME

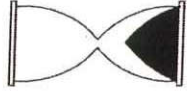

45 min

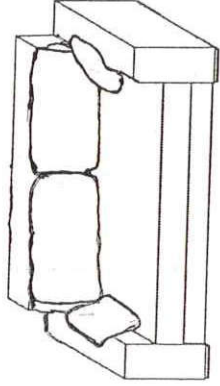
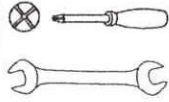
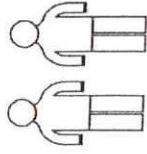

D

Montageanleitung

GB

Assembly instructions

FR

Notice de montage

IT

Istruzioni di montaggio

NL

Handleiding voor de montage

PL

Instrukcja montażu

CZ

Montážní návod

SK

Návod na montáž

HU

Szerelési útmutató

RO

Instrucțiuni de montaj

TR

Montaj talimatı

Инструкция по монтажу

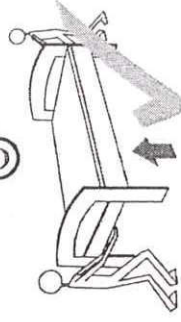
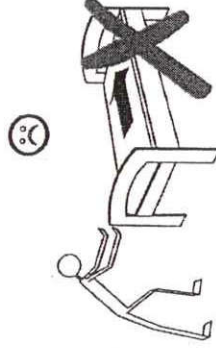
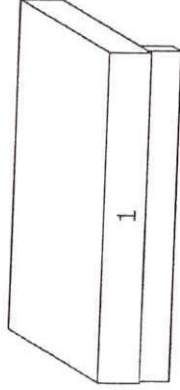
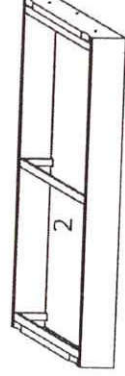
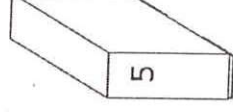
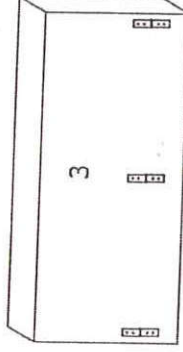
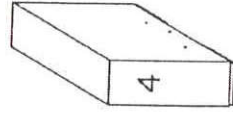
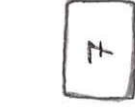
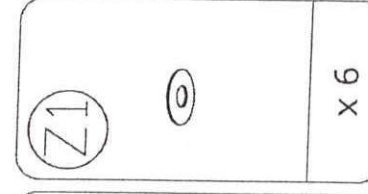
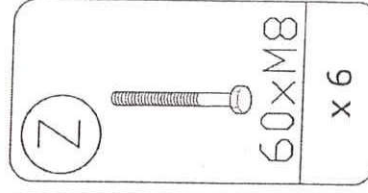
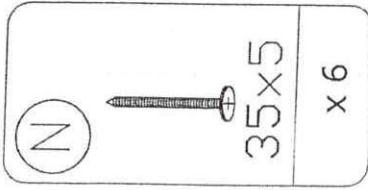

1

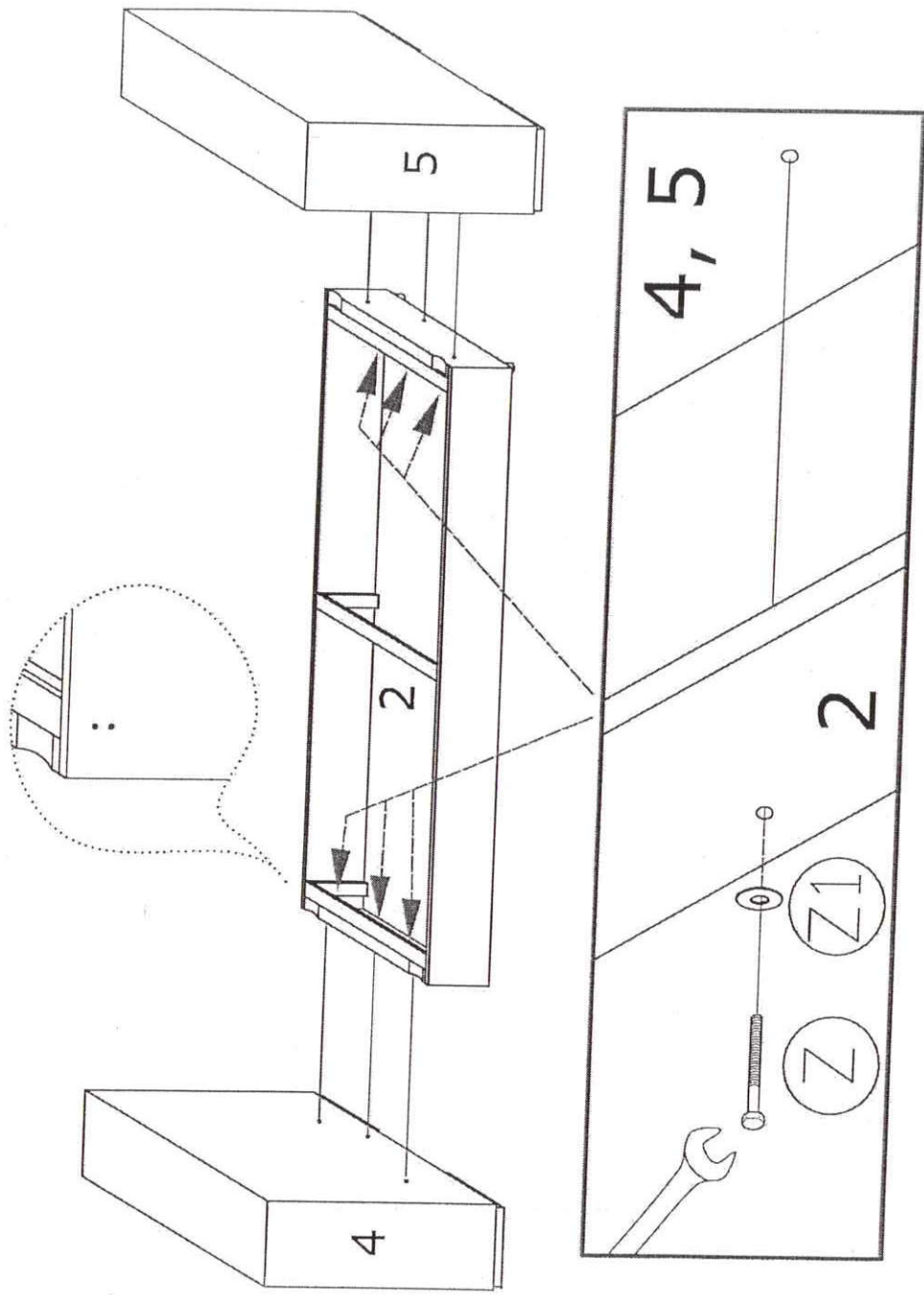

2

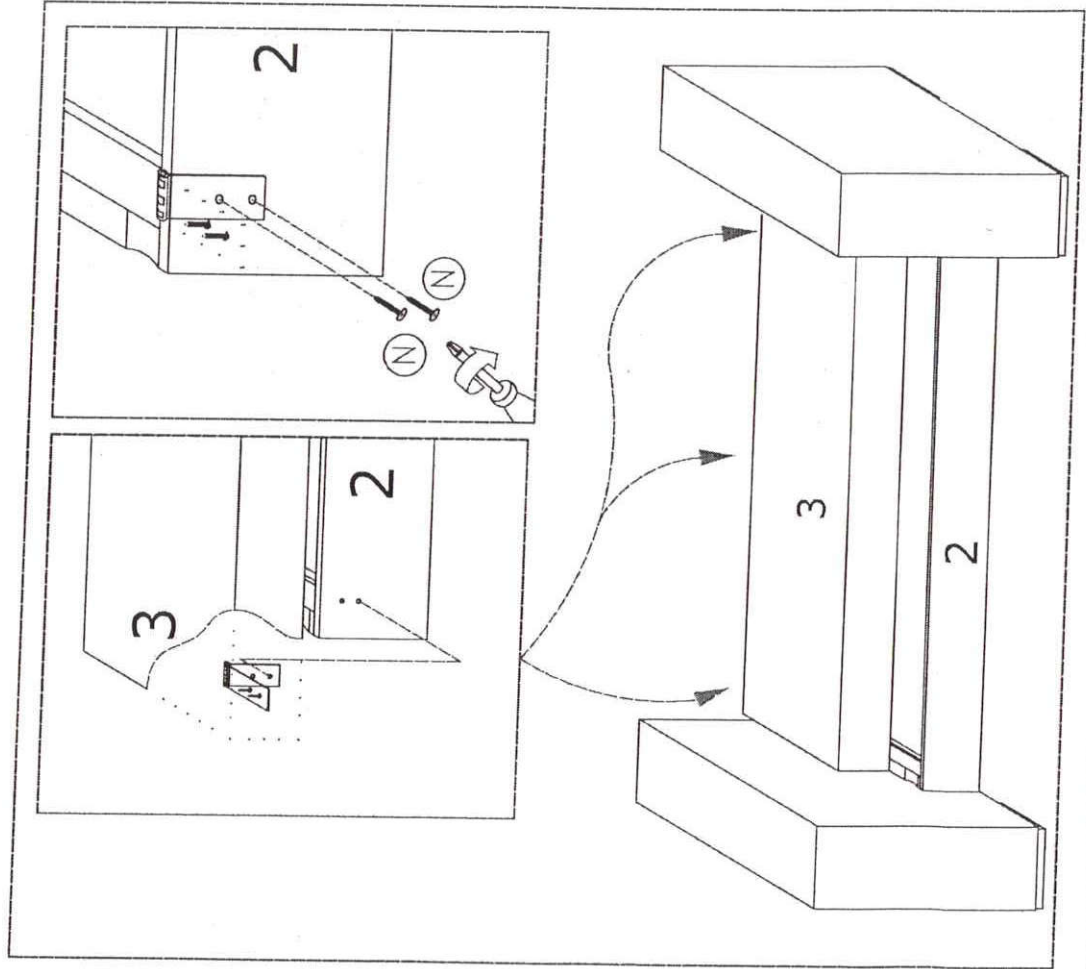
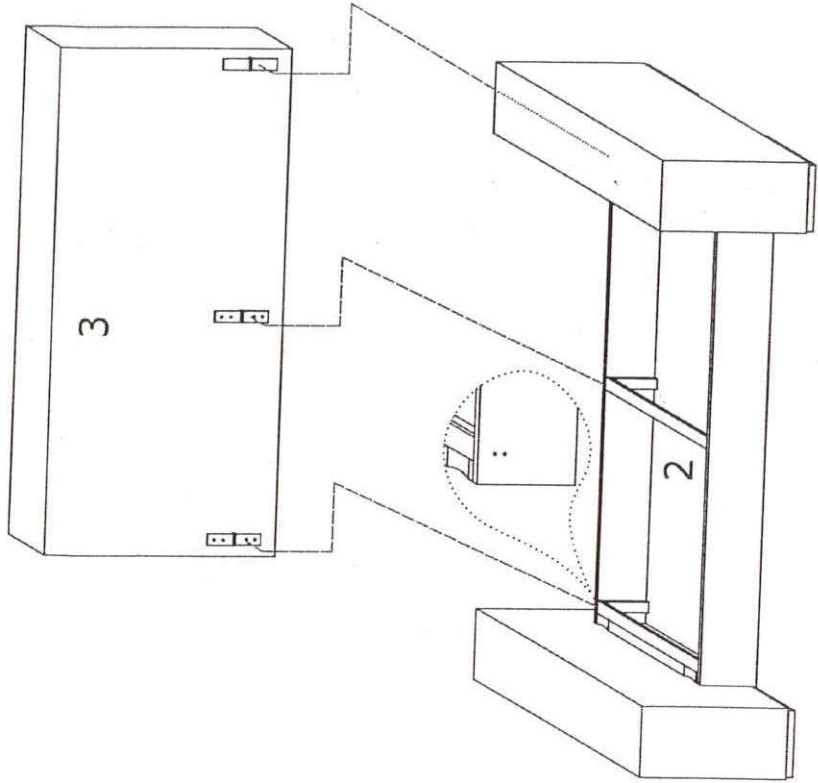

3

