

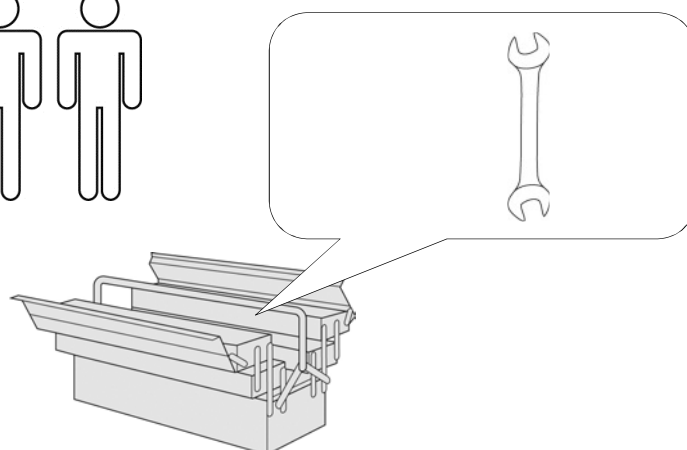

Jersey

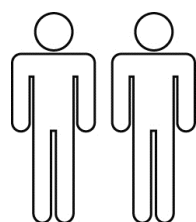

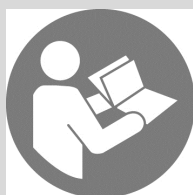



- | | |
|----------------------------------|---------------------------------------|
| D Montageanleitung | GB Assembly instructions |
| FR Notice de montage | NL Handleiding voor de montage |
| CZ Montážní návod | IT Istruzioni di montaggio |
| RO Instrucțiuni de montaj | RU инструкция по сборке |
| PL Instrukcja montażu | SK Návod na montáž |
| HU Szerelési útmutató | TR Montaj talimatı |

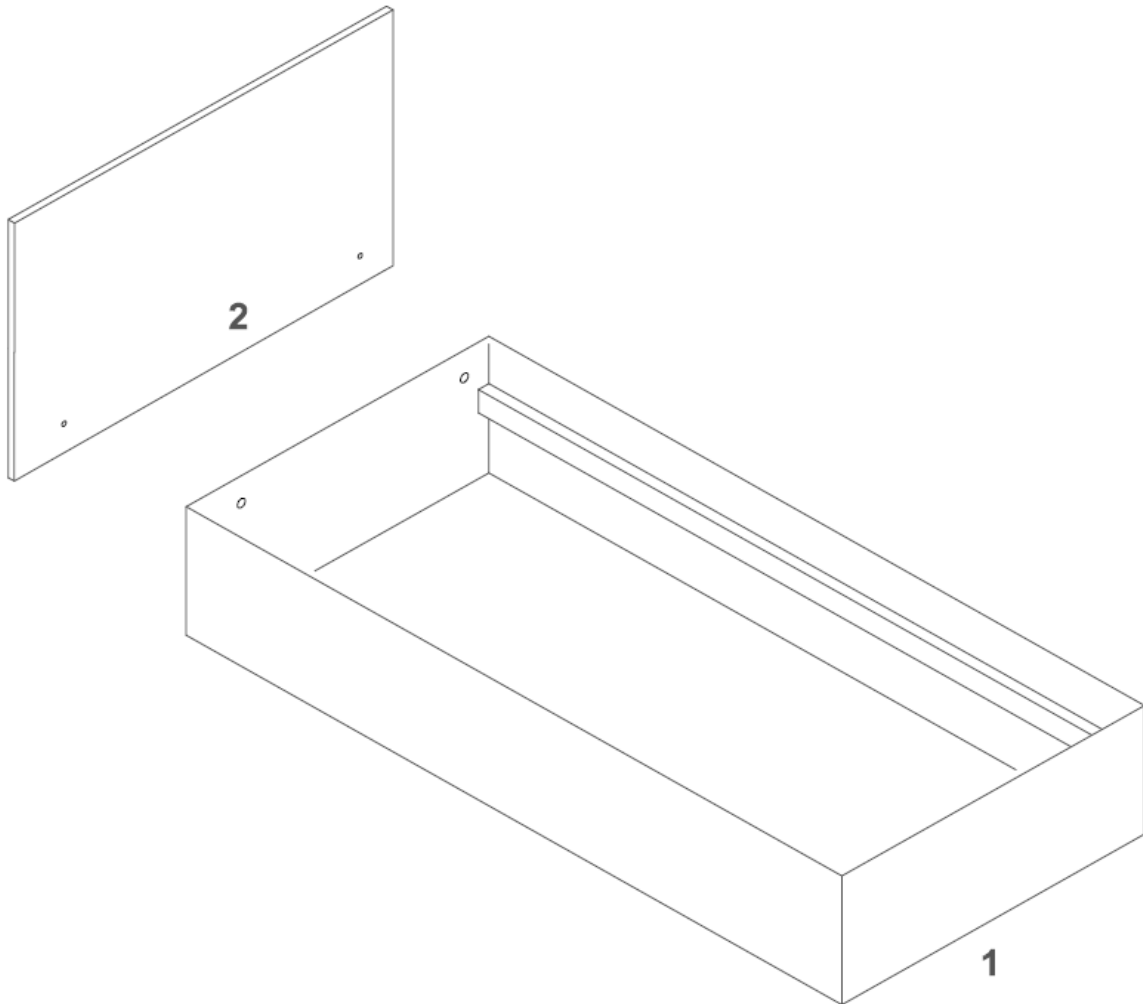

0
10
20
30
40
50
60
70
80
90
100
110
120
130
140
150
160
170
180
190
200

Service • Assistenza • Dienstverlening • Serwis Servis • Szerviz • Сервисная служба	
Name • Nom • Nome • Naam Nazwa • Jméno • Názov • Név Denumire • Ísim • Название	Jersey EB
Nr. • No. • N° • Номер • Č • Sz	SH55
Typ • Type • Tip • Típus • Тіро Тип	OHNE
	
	



A	B	C	D
			
2x	4x 8x60	4x 8x40	4x M8

0
10
20
30
40
50
60
70
80
90
100
110
120
130
140
150
160
170
180
190
200

Service • Assistenza • Dienstverlening • Serwis Servis • Szerviz • Сервисная служба	
Name • Nom • Nome • Naam Nazwa • Jméno • Názov • Név Denumire • Ísim • Название	Jersey EB
Nr. • No. • N° • Номер • Č • Sz	SH55
Typ • Type • Tip • Típus • Тіро Тип	LARO

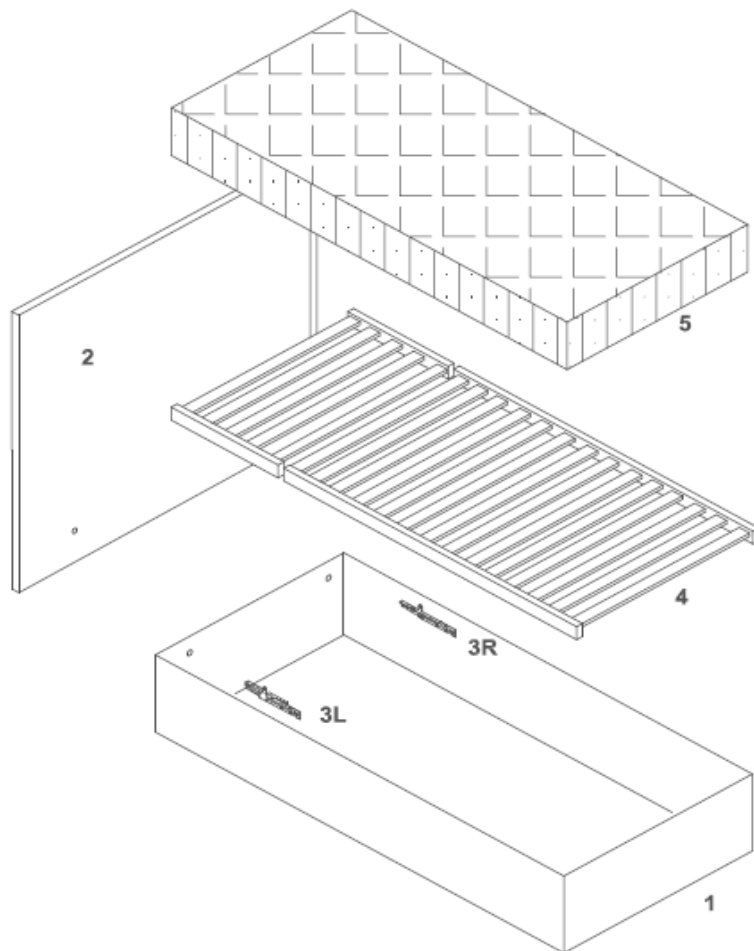

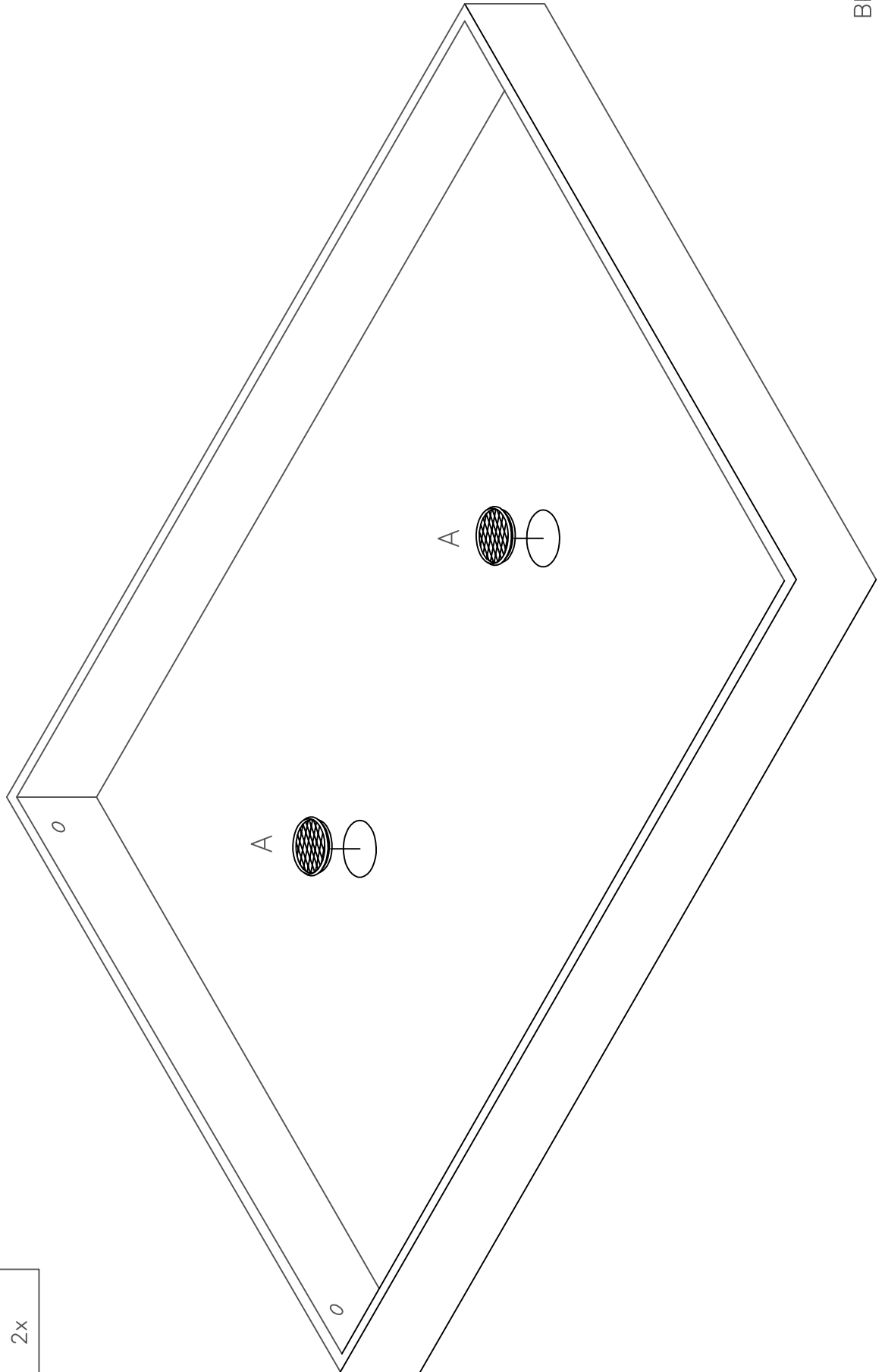

A	B	C	D
2x	4x 8x60	4x 8x40	4x M8



A		2x
---	---	----



B	C	D	Achtung! Schrauben nicht überdrehen	GB Watch Out! Do not over tighten
 <p>4x 8x60</p>	 <p>4x 8x40</p>	 <p>4x M8</p>	<p>FR Attention! Ne serrez pas trop</p> <p>CZ Dávej Pozor! Nepřetahujte</p> <p>RO Ai Grija! Nu strângeji</p> <p>PL Uwaga! Nie dokręcać zbyt mocno</p> <p>HU Vigyázz! Ne húzza túl</p>	<p>NL Let Op! Niet te vast</p> <p>IT Attenzione! Non stringere</p> <p>RU Осторожно! Не затягивайте</p> <p>SK Dávaj Pozor! Nepretahujte</p> <p>TR Dikkat! Üzerinde sıkmayın</p>

