

PUCCINI/PUCCI
8100/2500-0037/8142
8141/2500-0037/8300

- | | | | |
|-----------|--------------------------------------------------------|-----------|-----------------------------------------------------|
| D | MONTAGEANLEITUNG
BEDIENUNGSANLEITUNG | GB | ASSEMBLY INSTRUCTIONS
INSTRUCTION MANUAL |
| NL | HANDLEIDING VOOR DE MONTAGE
GEBRUIKSAANWIJZING | PL | INSTRUKCJA MONTAŻU
INSTRUKCJA OBSŁUGI |
| TR | MONTAJ TALIMATI
KULLANIM KLAVUZU | RU | ИНСТРУКЦИЯ ПО МОНТАЖУ
ИНСТРУКЦИЯ ПО ЭКСПЛУАТАЦИИ |
| RO | INSTRUCȚIUNI DE INSTALARE
INSTRUCȚIUNI DE UTILIZARE | IT | ISTRUZIONI DI MONTAGGIO
MANUALE DI ISTRUZIONI |
| FR | NOTICE DE MONTAGE
MANUEL INSTRUCTIONS | SK | MONTÁŽNY NÁVOD
NÁVOD NA POUŽITIE |
| HU | KÖZGYŰLÉS UTASÍTÁSOK
KEZELÉSI UTASÍTÁS | CZ | MONTÁŽNÍ NÁVOD
NÁVOD K POUŽITÍ |
| SI | NAVODILA ZA MONTAŽO
NAVODILA ZA UPORABO | PT | INSTRUÇÕES DE MONTAGEM
MANUAL DO USUÁRIO |
| ES | INSTRUCCIONES DE MONTAJE
MANUAL DEL USUARIO | HR | UPUTE ZA MONTAŽU
UPUTE ZA UPOTREBU |

F/B

191124

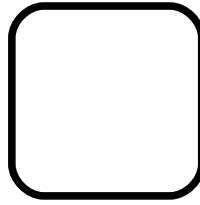
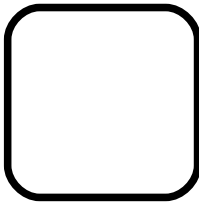

0019

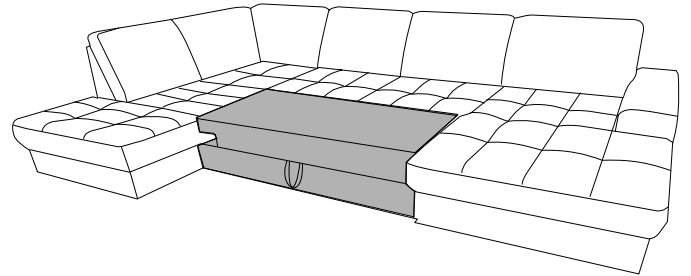
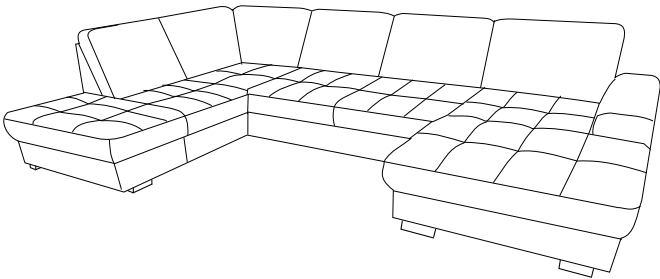

0019

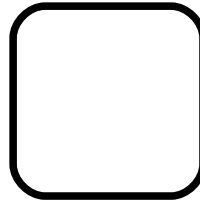
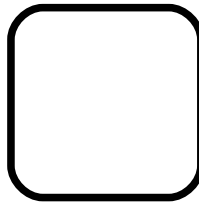

0089

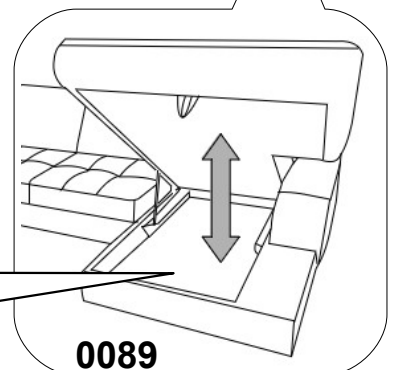
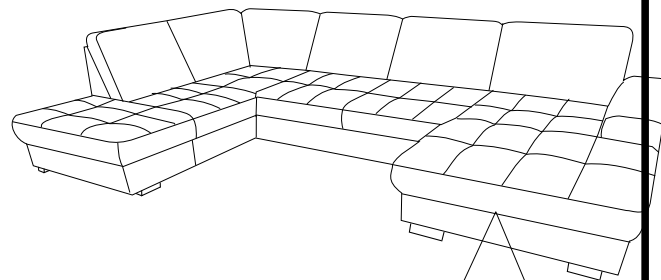
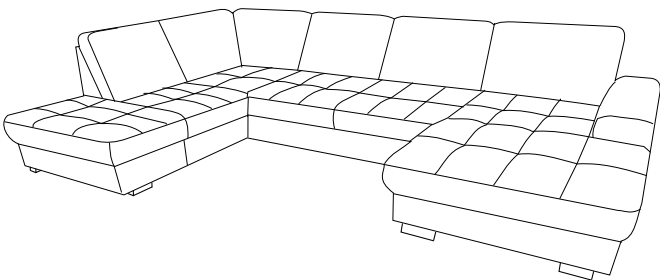
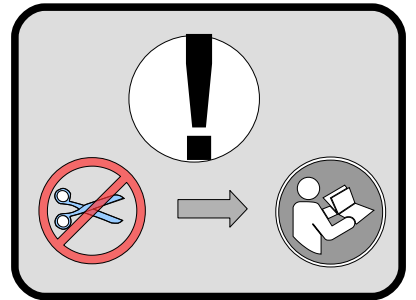

0089



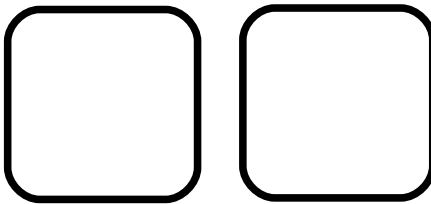

0088

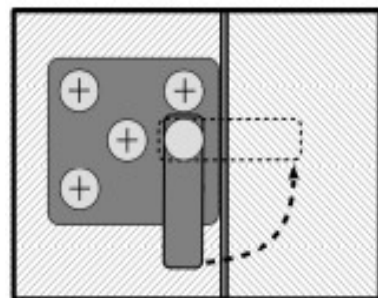
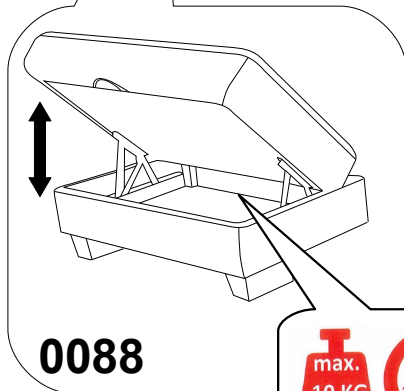
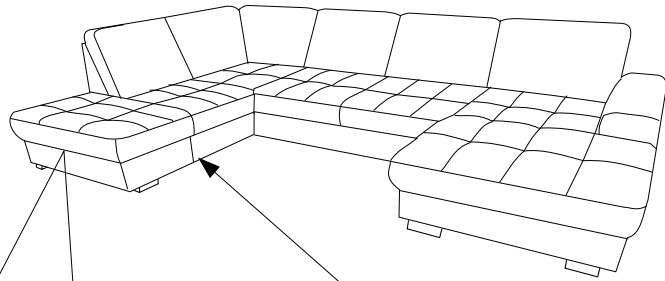
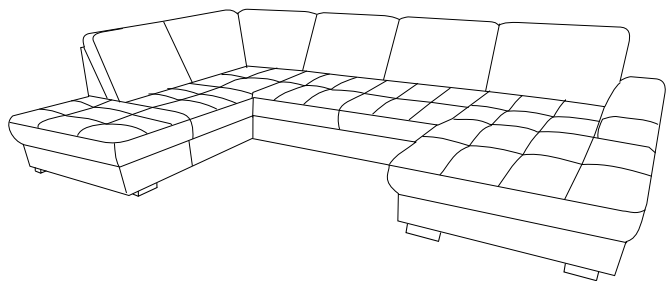

0088

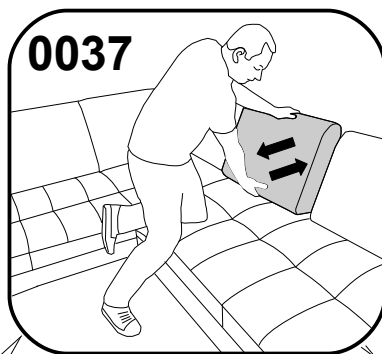

0037

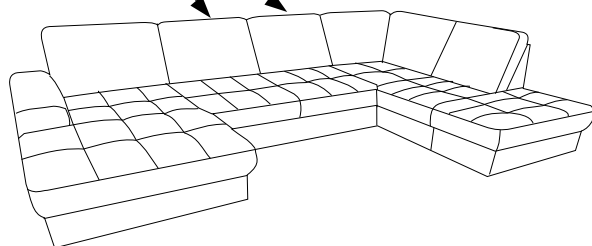
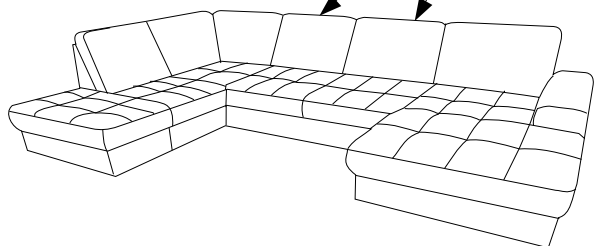





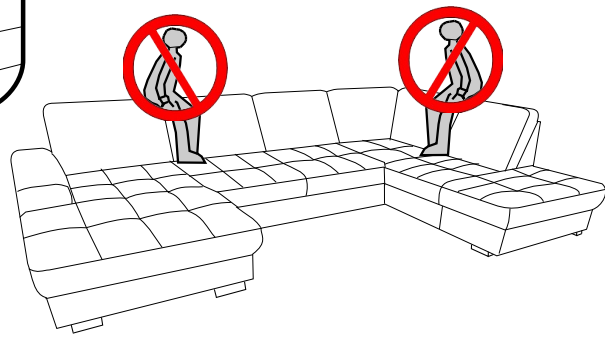
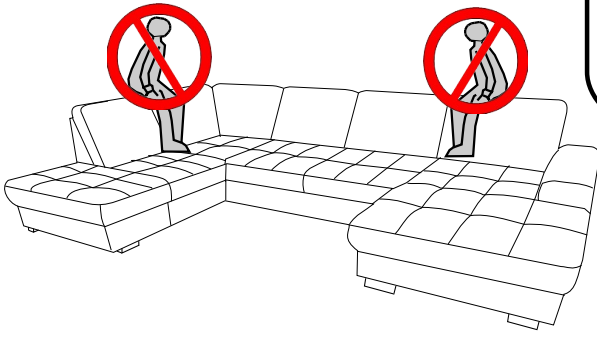
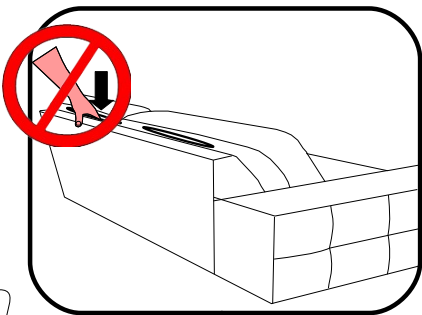

L

R





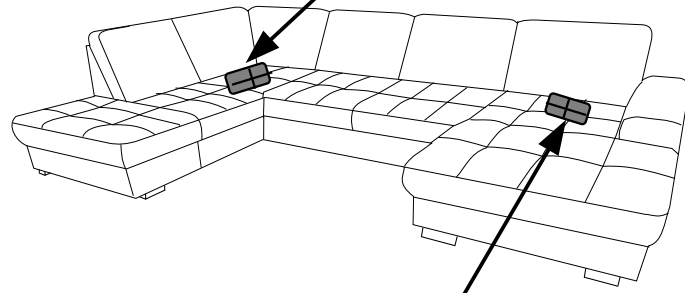

0
10
20
30
40
50
60
70
80
90
100
110
120
130
140
150
160
170
180
190
200

g H-90  X3	s H-90  X2	q M8*80  X6	i L-5  X1	f H-90  X2	x Fi-50  X6
----------------------------------------------------------------------------------------------------------	----------------------------------------------------------------------------------------------------------	-----------------------------------------------------------------------------------------------------------	---------------------------------------------------------------------------------------------------------	------------------------------------------------------------------------------------------------------------	-------------------------------------------------------------------------------------------------------------

[mm]





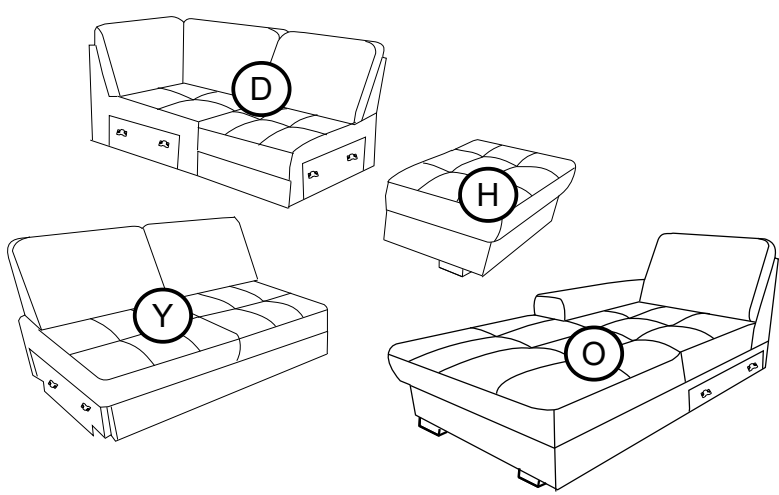
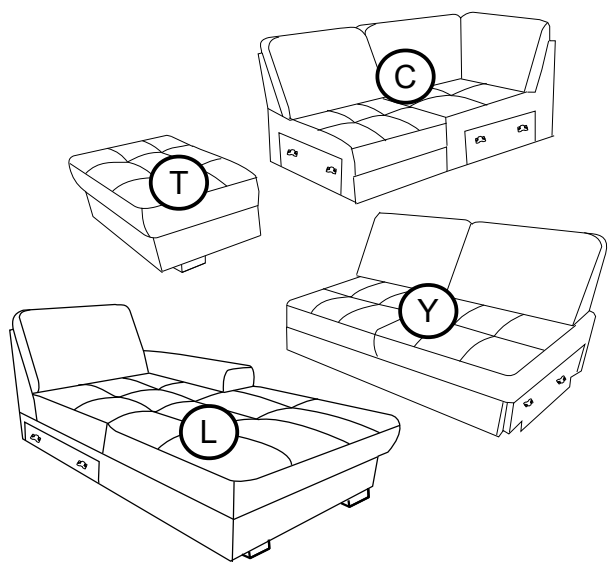

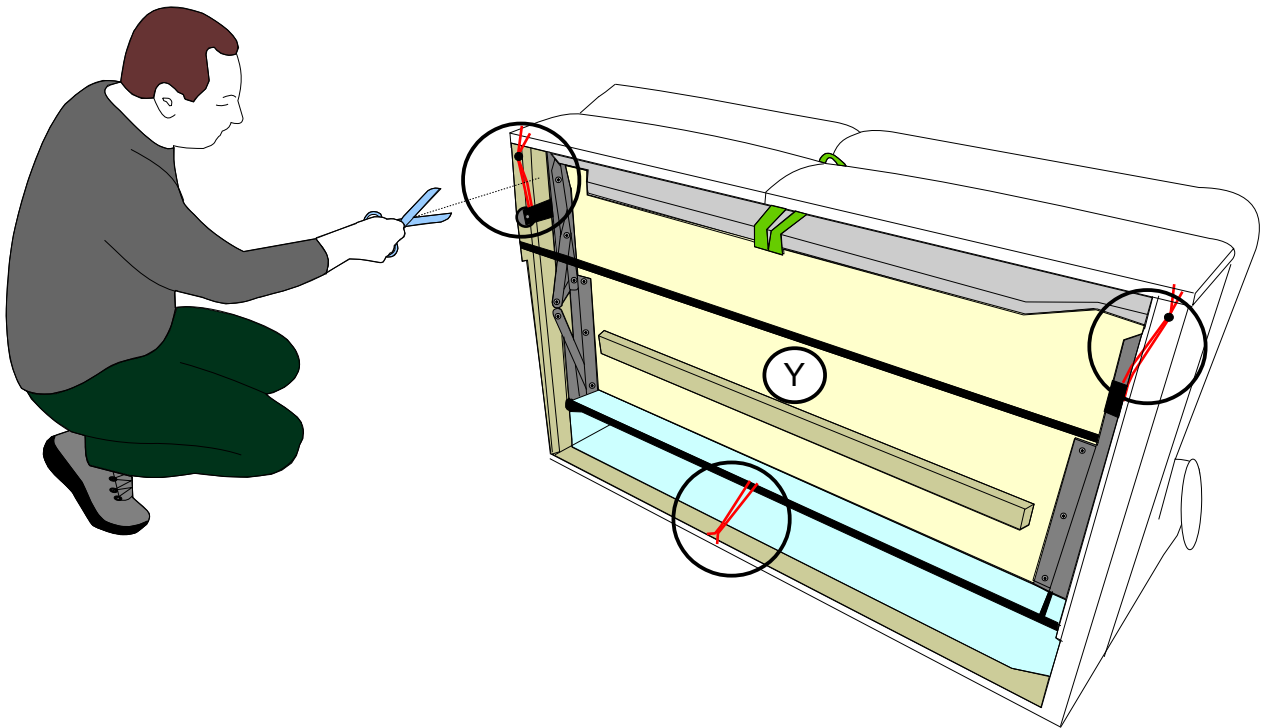
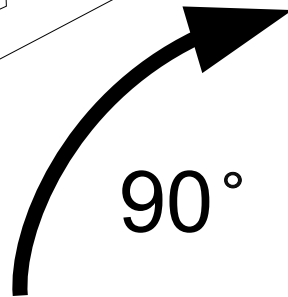
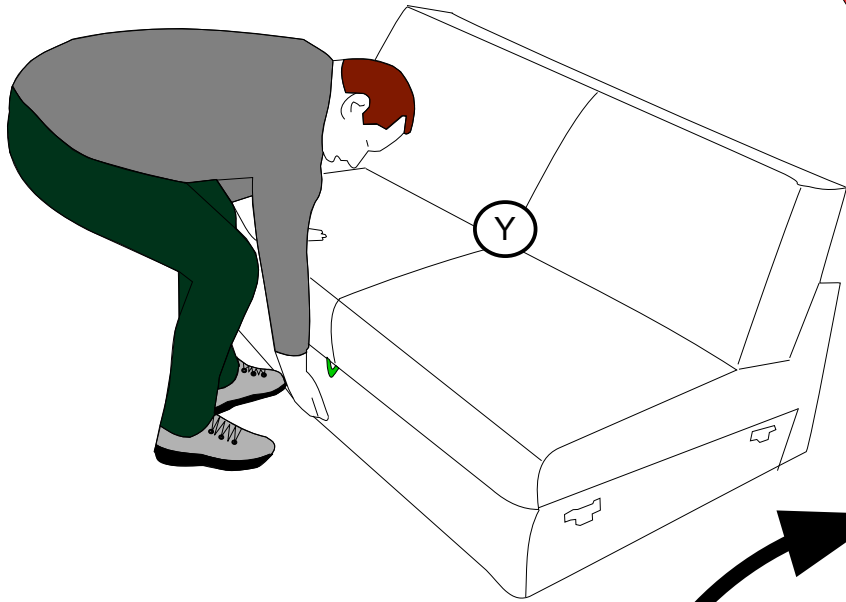
g H-90  X2	s H-90  X3	q M8*80  X7	x Fi-50  X7	f H-90  X1
------------------------------------------------------------------------------------------------------------	------------------------------------------------------------------------------------------------------------	-------------------------------------------------------------------------------------------------------------	---------------------------------------------------------------------------------------------------------------	--------------------------------------------------------------------------------------------------------------









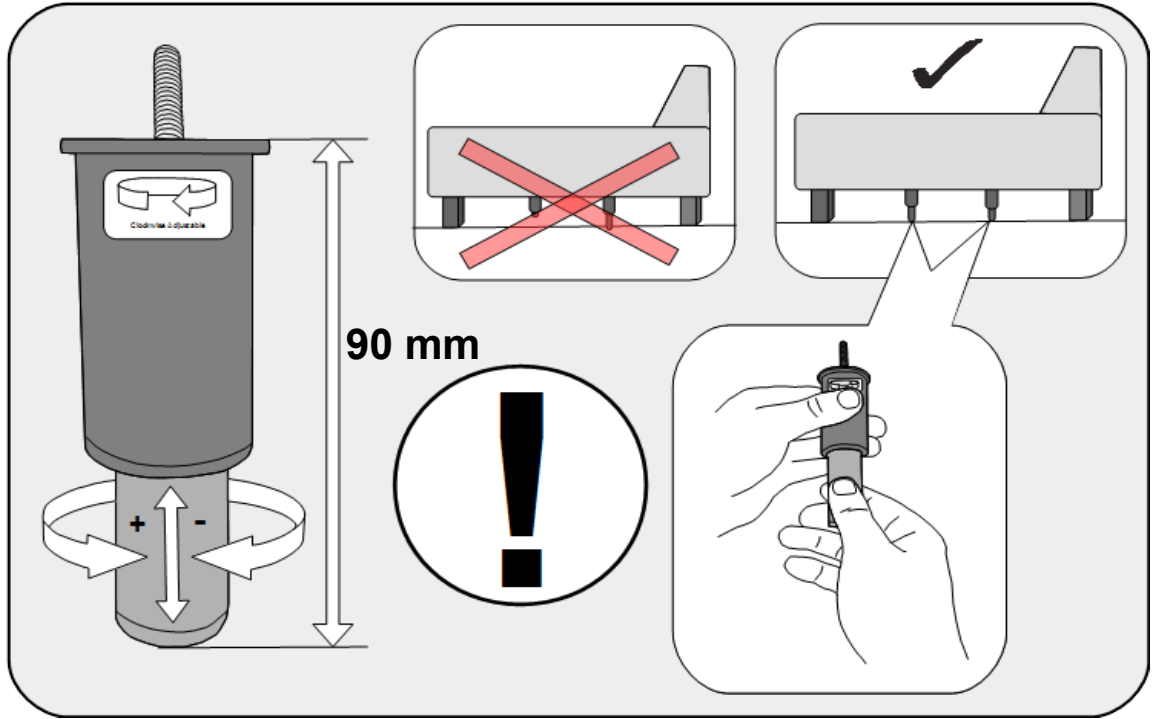
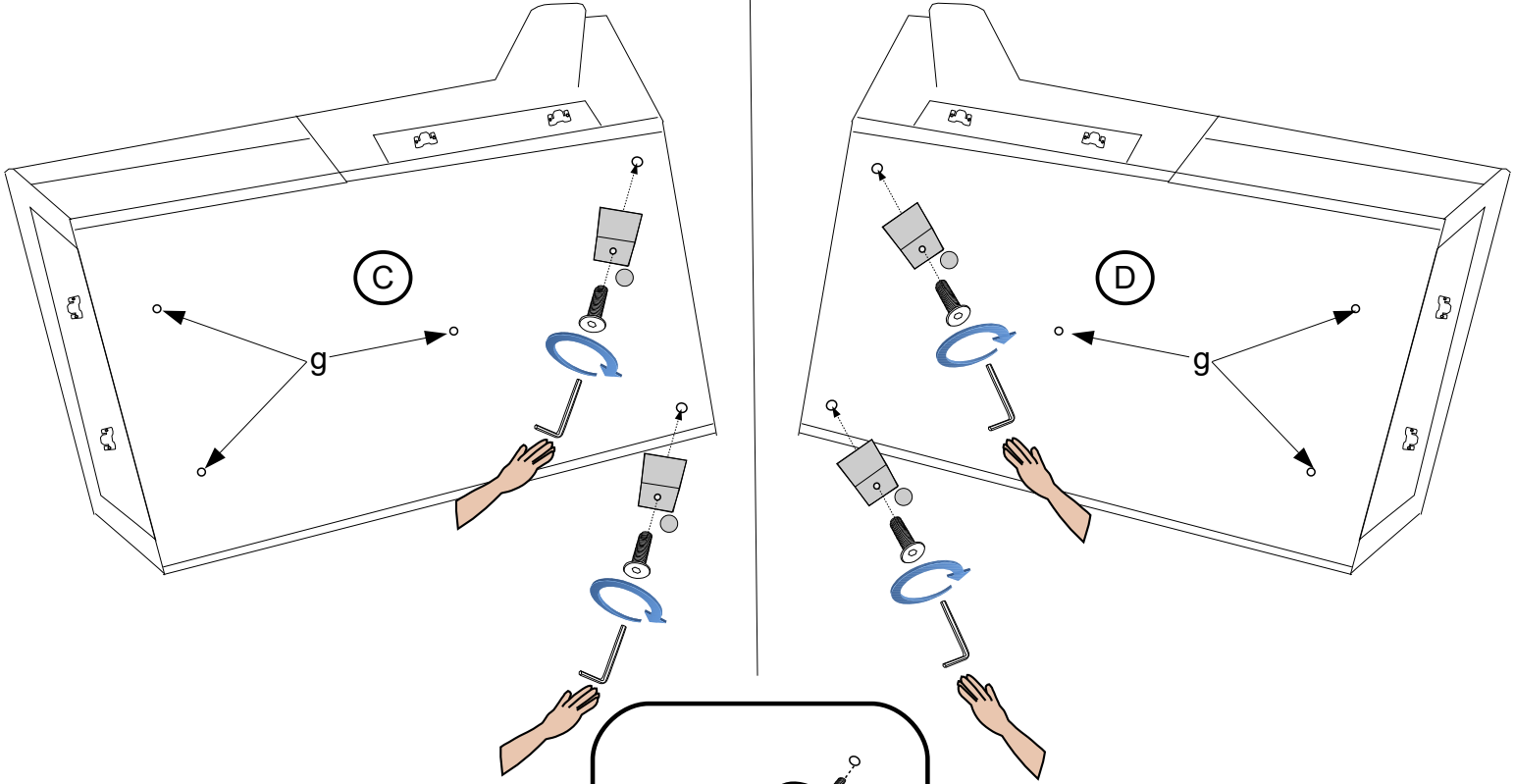



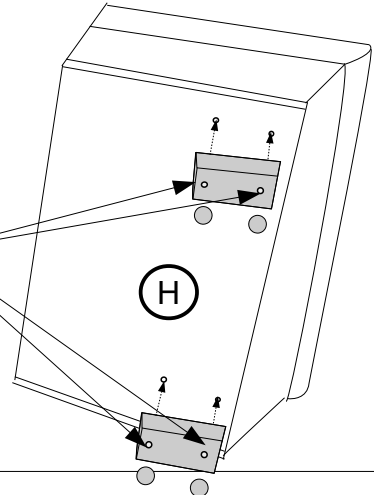
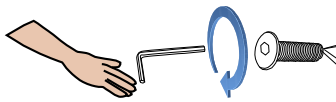
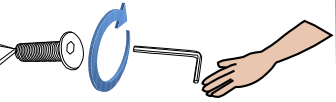
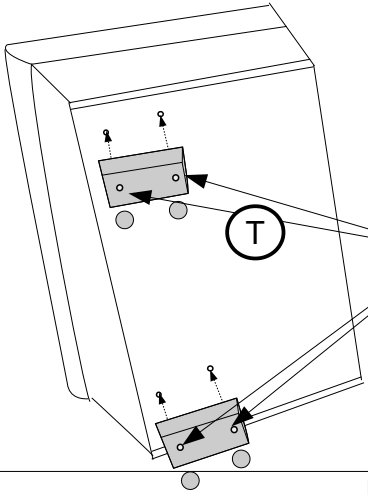

0019

g H-90 	f H-90 	q M8*80 	x Fi-50 	i L-5 
X3	X2	X2	X2	X1



x Fi- 50 	s H- 90 	q M8*80 	i L- 5 
X4	X2	X4	X1



f H- 90 	x Fi- 50 	s H- 90 	q M8*80 	i L- 5 	g H- 90 
X1	X7	X3	X7	X1	X2

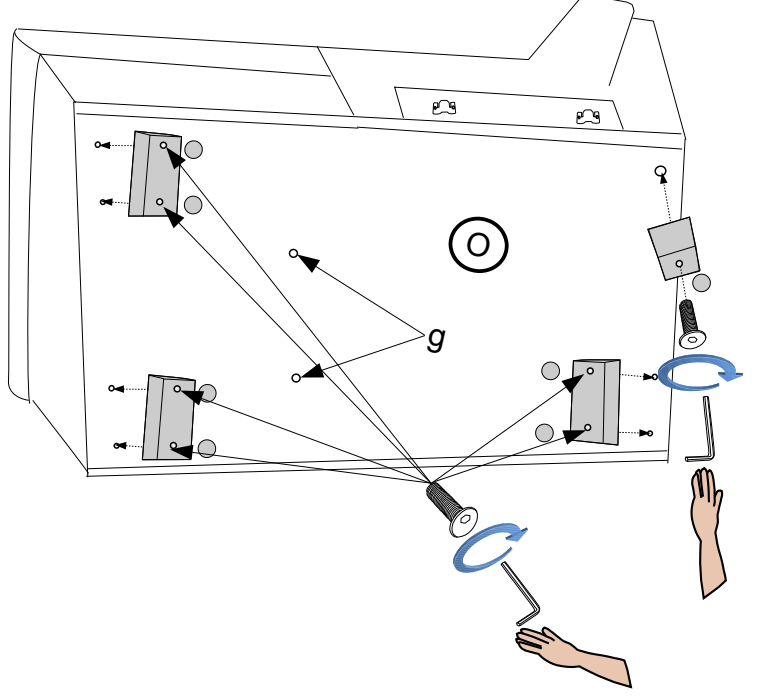
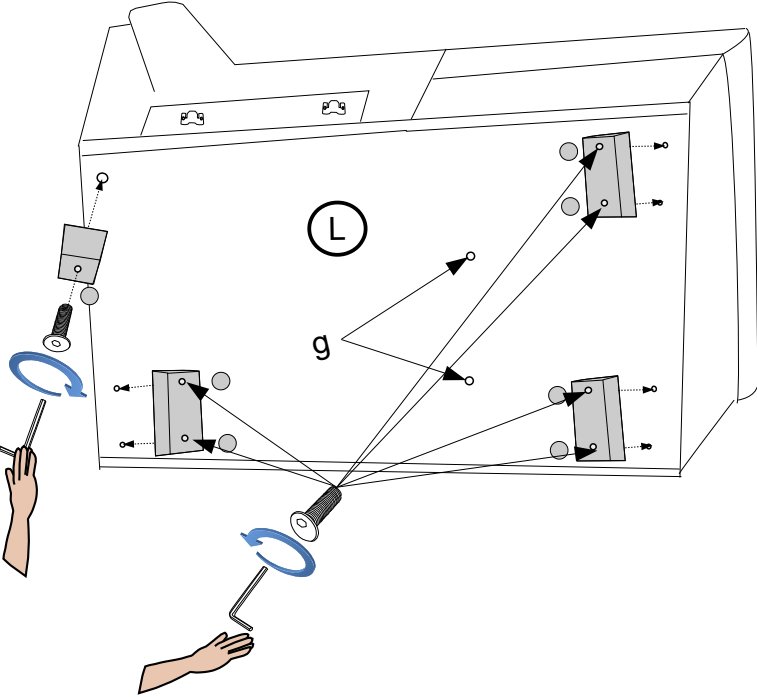

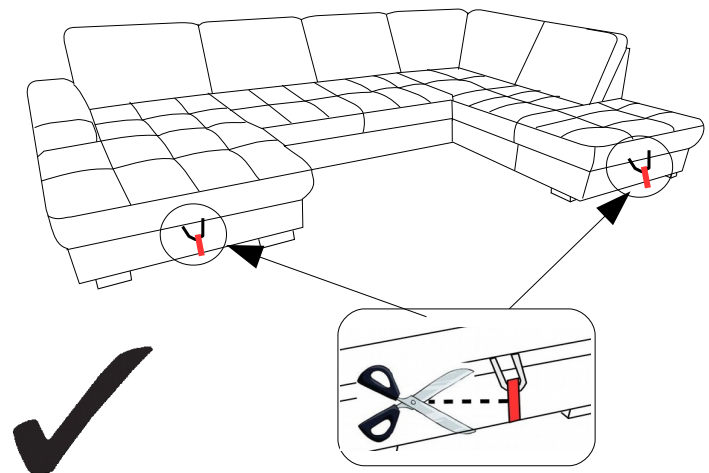
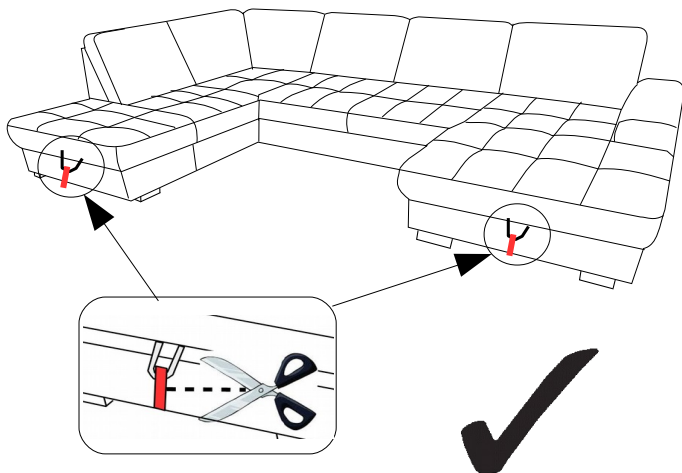
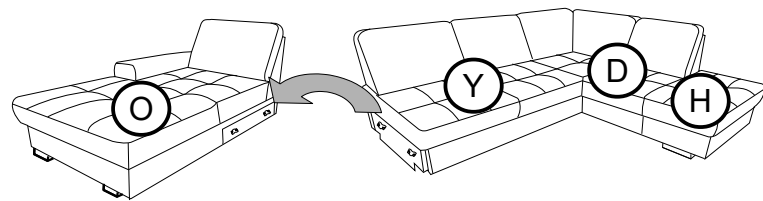
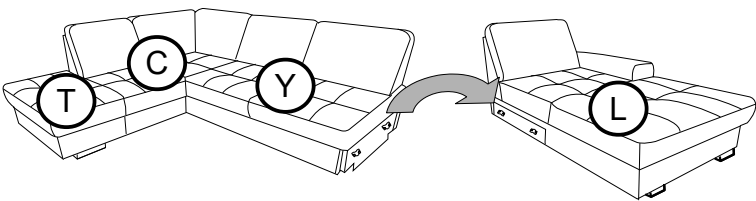
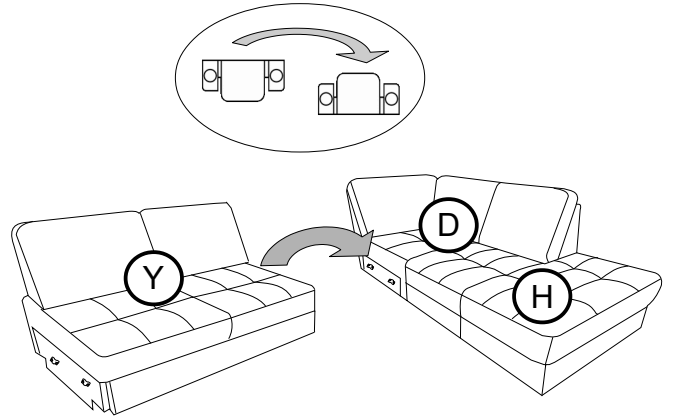
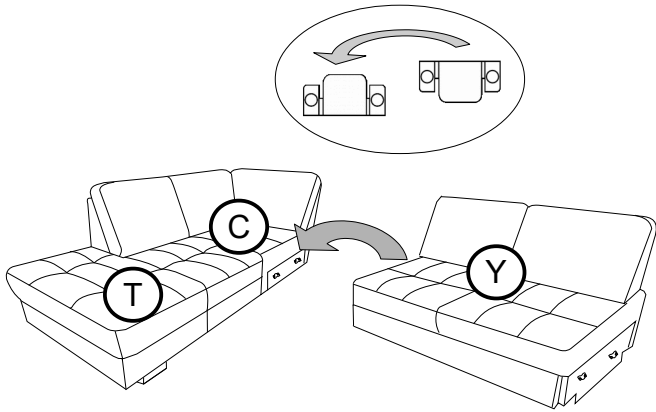
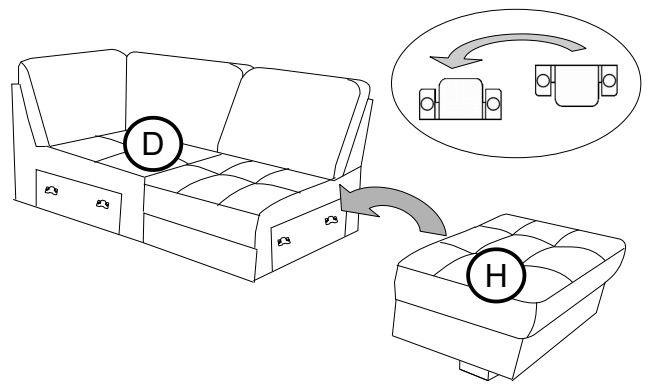
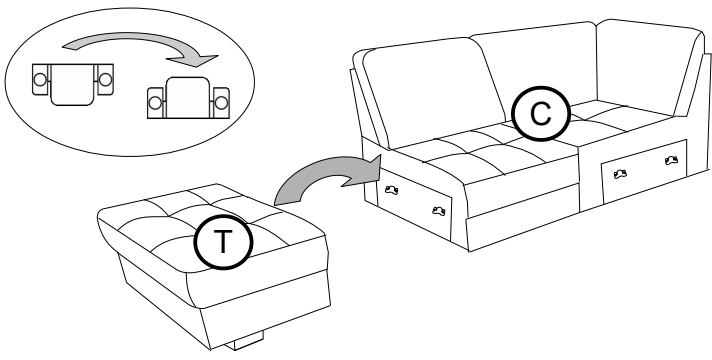

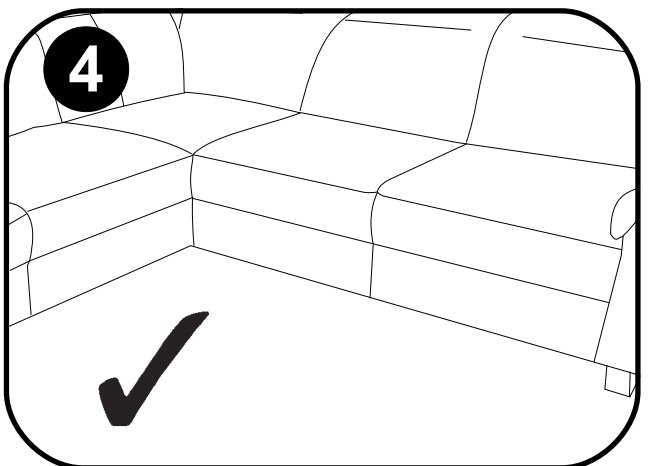
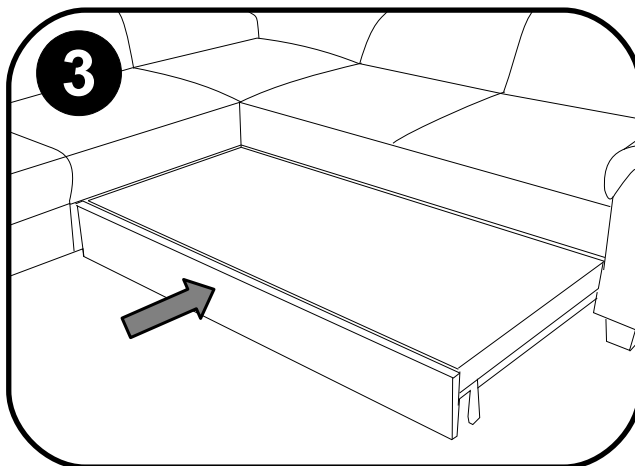
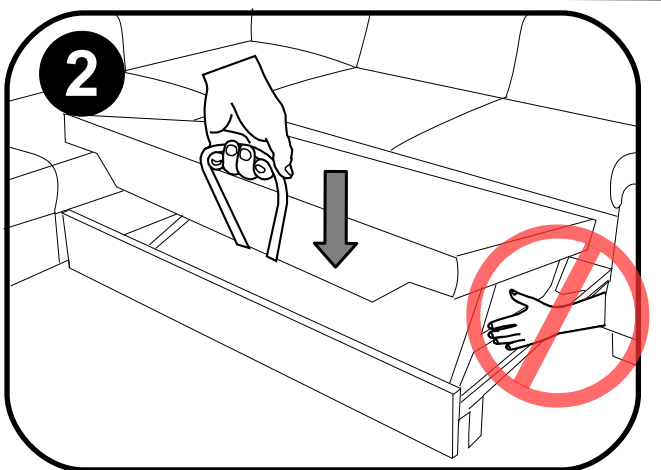
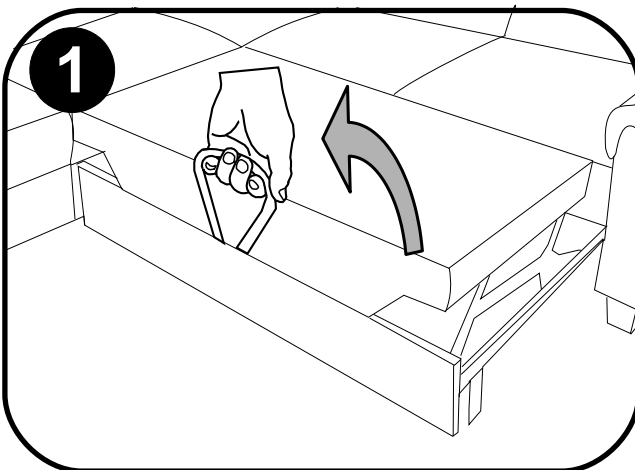
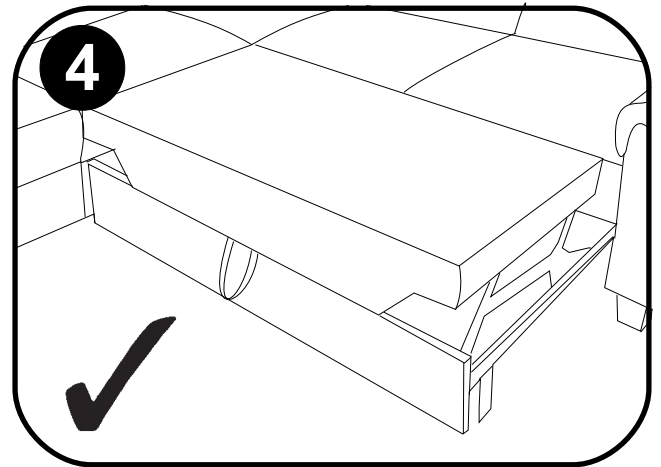
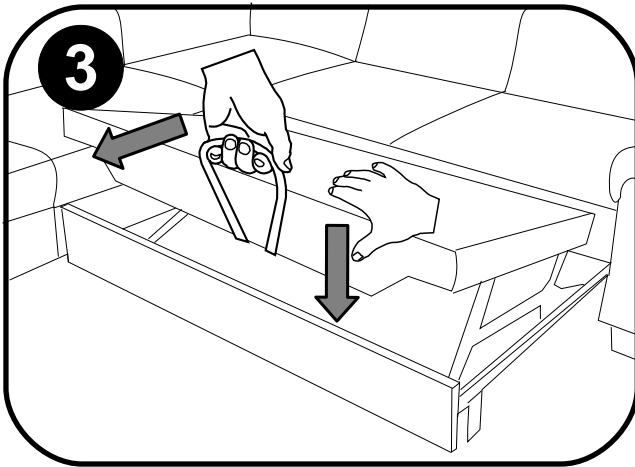
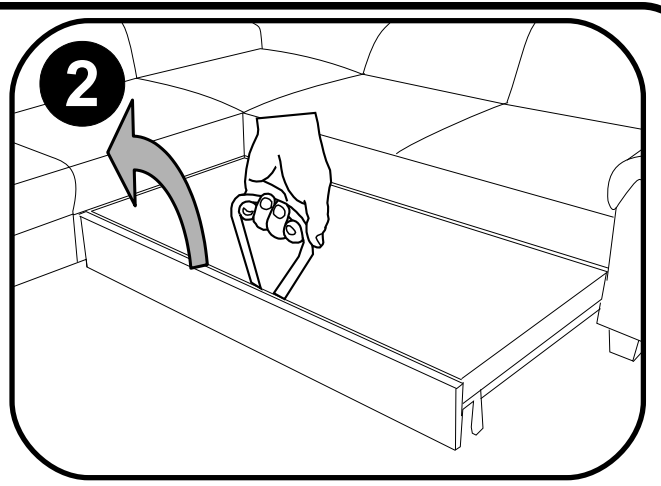
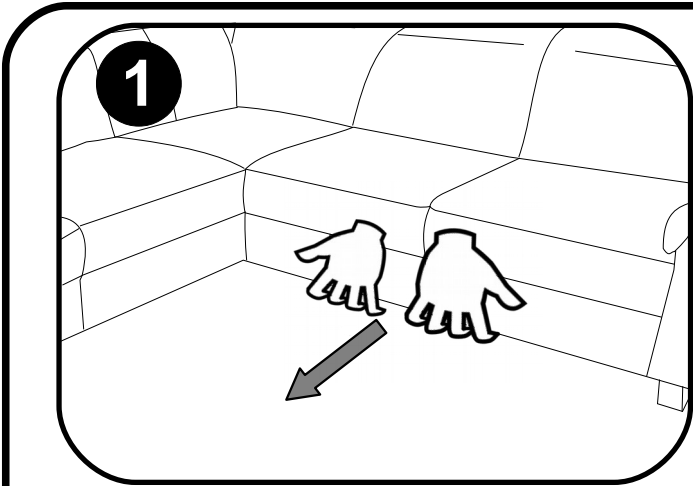
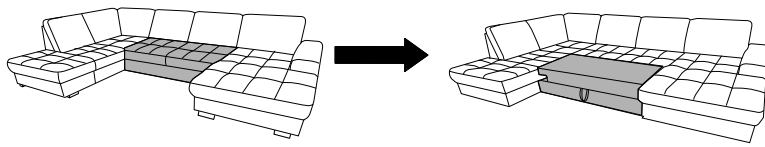

Service · Dienstverlening · Servis · Servis · Сервисная служба · Serviciu · Services · Servizio
 · Servisný list · Szolgáltatás · Servisní list

Name · Naam · Nazwa · İsim · Название · Nume · Nome · Názov · Názov ·
 Název · Neve
PUCCINI/PUCCI
 Тип · Type · Tip · Тип · Tipo · Típus

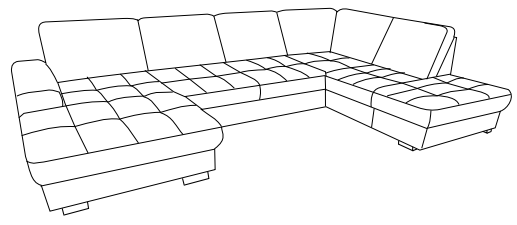
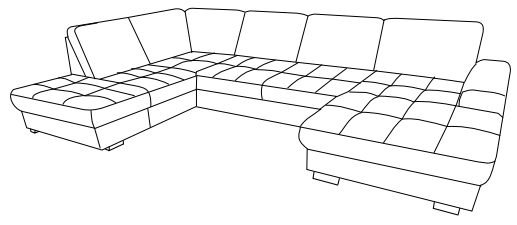
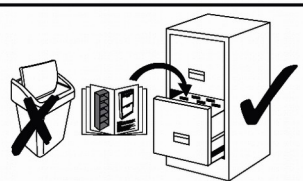
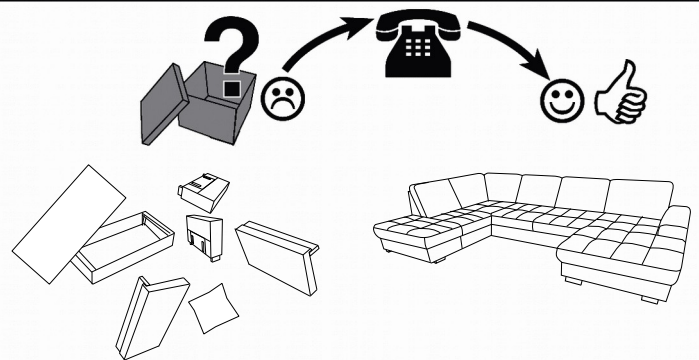

g H- 90 	f H- 90 	x Fi- 50 	s H- 90 	q M8*80 [mm]
--------------------	--------------------	---------------------	--------------------	-------------------------

