

Montageanleitung

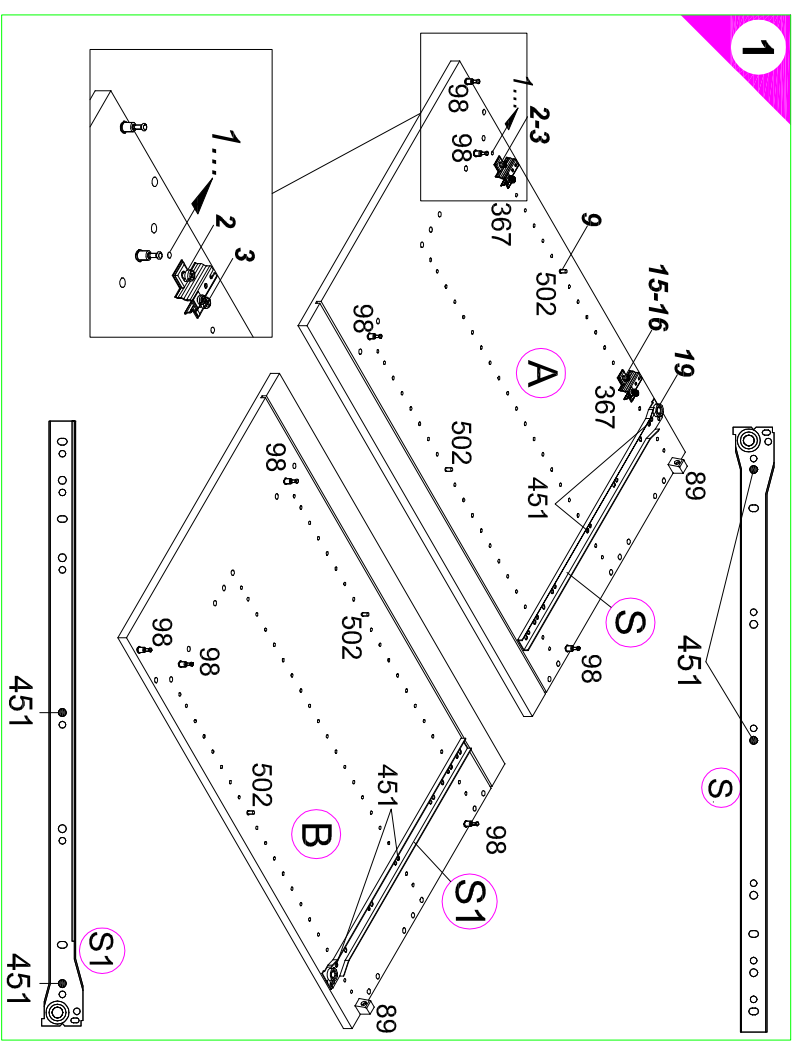

Service-Hotline
01805-678101
0,14€ pro Minute
++49 für Österreich
Auslandstarif pro Minute
service@optifit.de
voor Nederland en België
00800-40119350
benelux@optifit.de

- | | | | |
|-----------|----------------------|-----------------------|--------------|
| 1 | 8x
Nr.98 | 2x
Nr.367 | 4x
Nr.502 |
| 2 | 6x
Nr.76 | 12x
Ø8x30
Nr.80 | 2x
Nr.89 |
| 3 | 2x
Nr.76 | 2x
Ø8x30
Nr.80 | |
| 4 | 16x
Nr.204 | | |
| 5 | 2x
Nr.365 | | |
| 8 | 4x
4x30
Nr.164 | | |
| 10 | 2x
4x30
Nr.424 | | |

2

2

3

3

4

5

6

H J

7

8

9

10

Ersatzteile/ Spare parts/pièces de rechange/Reserveonderdelen/Piezas de recambio/Ricambi/Запасные части/Części zamienne/pótkalkatárszek/Náhradní části/Nadomesni deli/varaosat/reservdelar

30cm U306-9	A E961021	B E961022	C E954216	D E950306	F E970976	G E970006	H E940614	J E970976	P E540106	S E946149	S1 E946148
30cm U0306-9	A E961021	B E961022	C E954216	D E950306	F E970976	G E970006	H E940614	J E970976	P E540106	S E946149	S1 E946148
40cm U406-9	A E961021	B E961022	C E954215	D E950305	F E970975	G E970010	H E940613	J E940564	P E540105	S E946149	S1 E946148
40cm U0406-9	A E961021	B E961022	C E954215	D E950305	F E970975	G E970010	H E940613	J E940564	P E540105	S E946149	S1 E946148
50cm U506-9	A E961021	B E961022	C E954224	D E950304	F E970974	G E970117	H E940612	J E940563	P E540104	S E946149	S1 E946148
50cm U0506-9	A E961021	B E961022	C E954224	D E950304	F E970974	G E970117	H E940612	J E940563	P E540104	S E946149	S1 E946148
60cm U606-9	A E961021	B E961022	C E954223	D E950303	F E970973	G E970116	H E940611	J E940562	P E540103	S E946149	S1 E946148
60cm U0606-9	A E961021	B E961022	C E954223	D E950303	F E970973	G E970116	H E940611	J E940562	P E540103	S E946149	S1 E946148

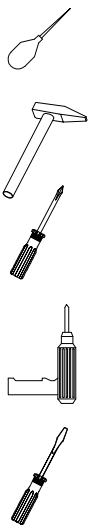

1 → 2 → 3 → ...

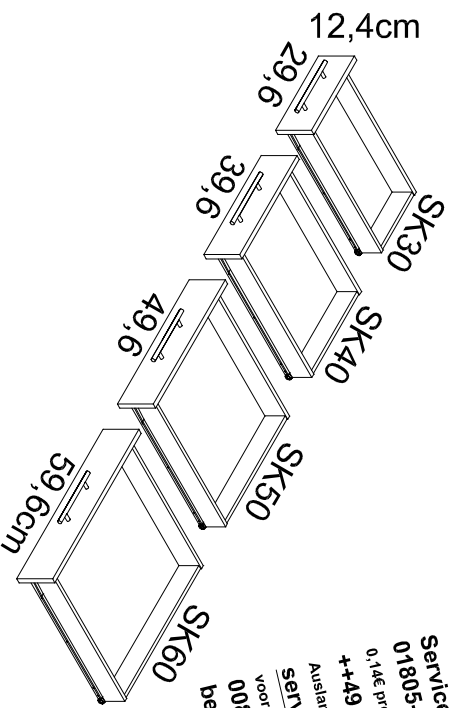
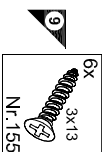
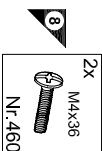
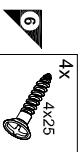

Service-Hotline
01805-678101
0,14€ pro Minute
+49 für Österreich
Auslandstarif pro Minute
Service@optifit.de
voor Nederland en België
00800-40119350
benelux@optifit.de

Montageanleitung

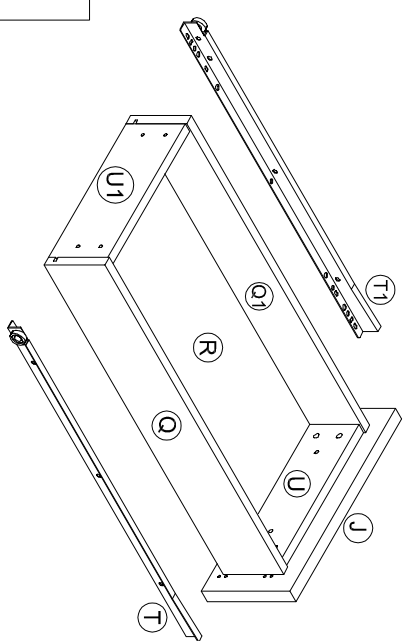

1

Holzunterlage verwenden!
Use a wooden base!
Utiliser un support en bois!
Houten onderlegger gebruiken!
Utilizar bases de madeira!
Utilizzare una base di legno!
Используй деревянную подложку!
Używać podkładki z drewna!
Použíjte dřevový podklad!
Проработать деревянный подклад!
Arvand et træunderlag!

2

3

4

5

10 min.

6

7

8

9

- Ersatzteile/Spare parts/pièces de rechange/Reserveonderdelen/Piezas de recambio/Ricambi/Замачные части/Części zamiennel/pótkallatrészek/Náhradní části/Nadomestni deli/Varasat/reservdelar
- SK 30 ① E945400 ① E945400 ① E970153 ① E946151 ① E946150 ① E945405 ① E945405 ① E945405 ① E945406 ① E945406 ① E945407 ① E945407 ① E945408 ① E945408 ① E945408
 - SK 40 ① E945400 ① E945400 ① E970152 ① E946151 ① E946150 ① E945406 ① E945406 ① E945406 ① E945407 ① E945407 ① E945407 ① E945407 ① E945408 ① E945408 ① E945408
 - SK 50 ① E945400 ① E945400 ① E970151 ① E946151 ① E946150 ① E945406 ① E945406 ① E945406 ① E945407 ① E945407 ① E945407 ① E945407 ① E945408 ① E945408 ① E945408
 - SK 60 ① E945400 ① E945400 ① E970150 ① E946151 ① E946150 ① E945406 ① E945406 ① E945406 ① E945407 ① E945407 ① E945407 ① E945407 ① E945408 ① E945408 ① E945408

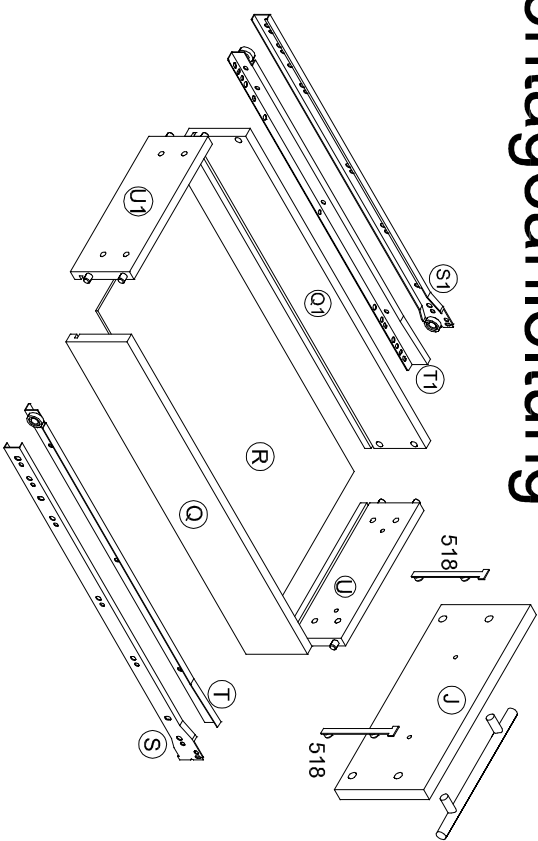
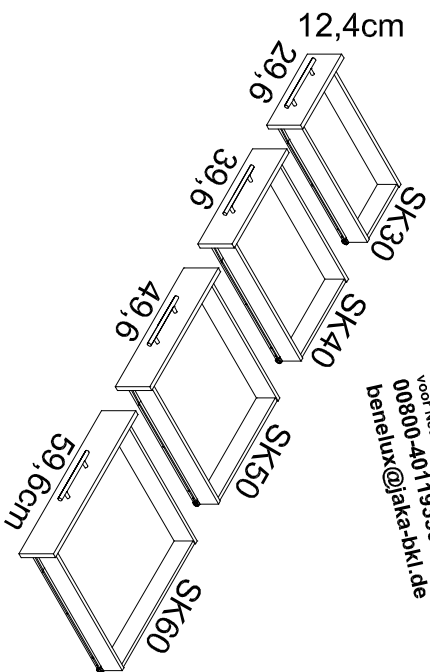
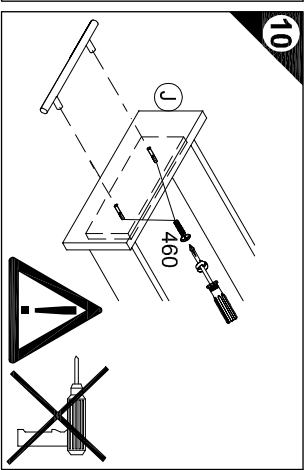
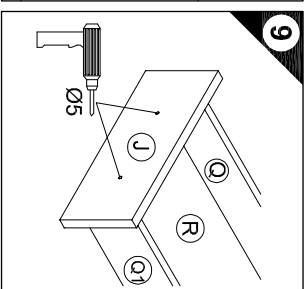
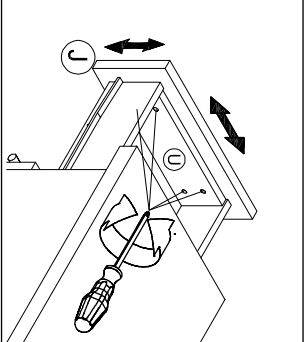
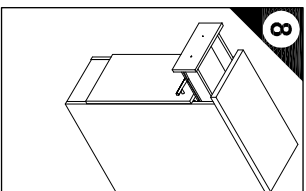
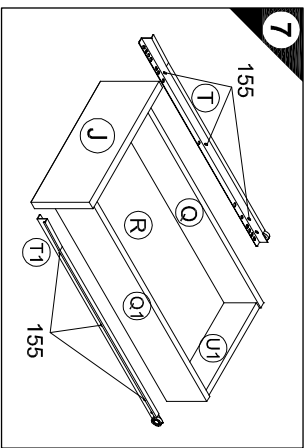
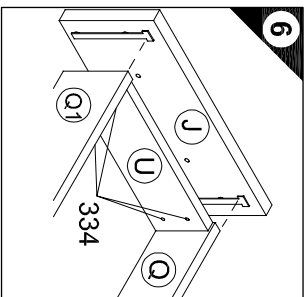
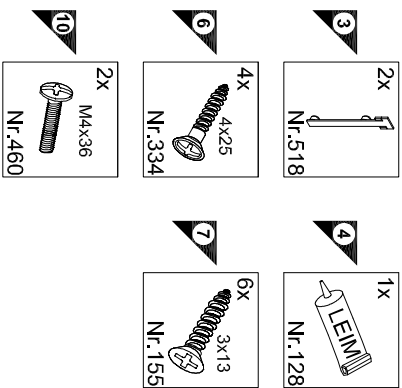
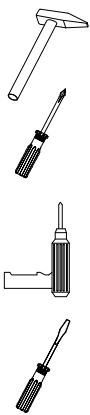

Montageanleitung

Service-Hotline
01 805-678101
0,14€ pro Minute
++49 für Österreich
Auslandstarif pro Minute
service@jaka-bkl.de
voor Nederland en België
00800-401 19350
benelux@jaka-bkl.de

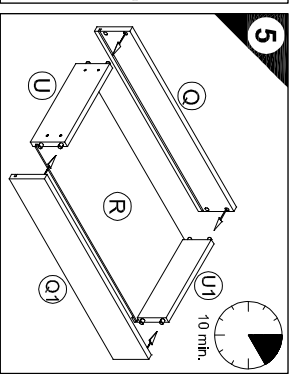
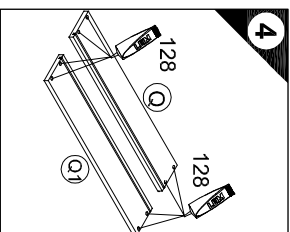
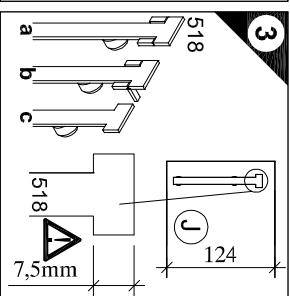
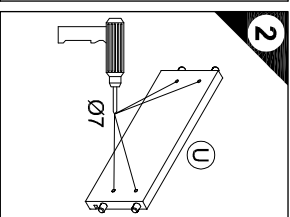
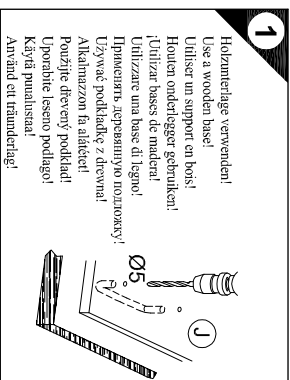

Ersatzteile/Spare parts/pièces de rechange/Reserveonderdelen/Piezas de recambio/Ricambi/Zaracarne uacrti/Części zamiennel/pótalakatárszek/Náhradní části/Nadomestini deli/Varosast/Reservdeler

- SK 30 ① E940565 ② E945400 ③ E970153 ④ E946149 ⑤ E946151 ⑥ E946150 ⑦ E945405 ⑧ E945405 ⑨ E945406 ⑩ E945407 ⑪ E945407
- SK 40 ① E940564 ② E945400 ③ E945400 ④ E946149 ⑤ E946151 ⑥ E946150 ⑦ E945406 ⑧ E945406 ⑨ E945407 ⑩ E945407 ⑪ E945407
- SK 50 ① E940563 ② E945400 ③ E945400 ④ E946149 ⑤ E946151 ⑥ E946150 ⑦ E945407 ⑧ E945407 ⑨ E945407 ⑩ E945407 ⑪ E945407
- SK 60 ① E940562 ② E945400 ③ E945400 ④ E970150 ⑤ E946149 ⑥ E946148 ⑦ E946151 ⑧ E946150 ⑨ E945408 ⑩ E945408 ⑪ E945408

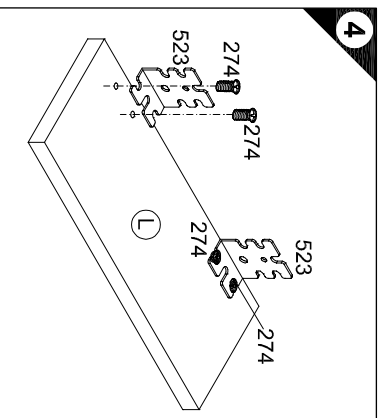
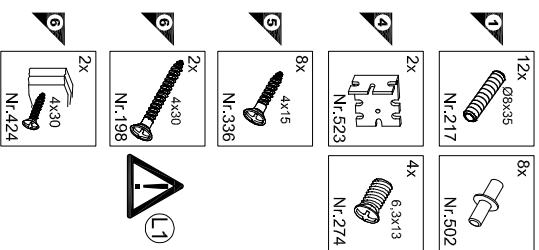
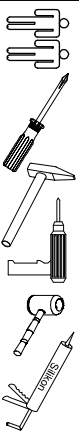

Service-Hotline
01805-678101
0,14€ pro Minute
++49 für Österreich
Auslandstarif pro Minute
service@jaka-bkl.de
voor Nederland en België
00800 40 119350
benelux@jaka-bkl.de

Montageanleitung

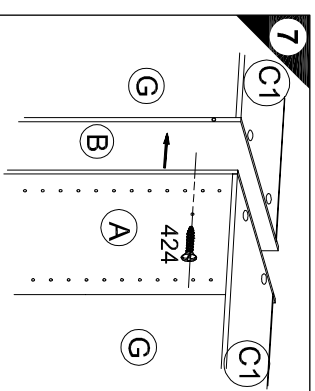
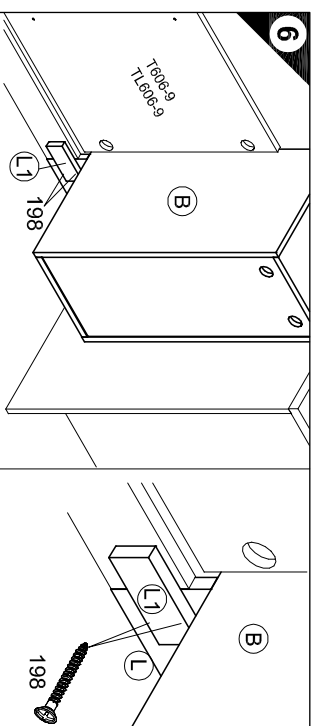
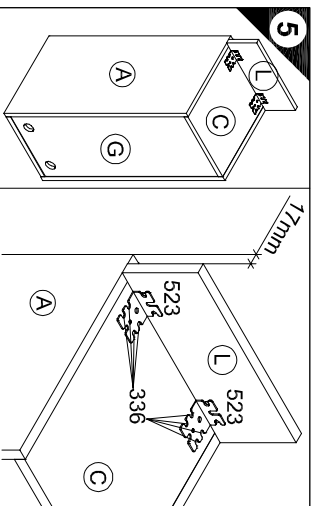
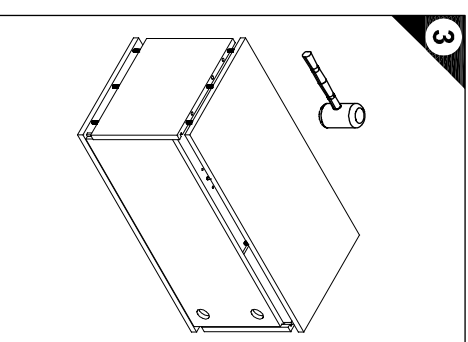
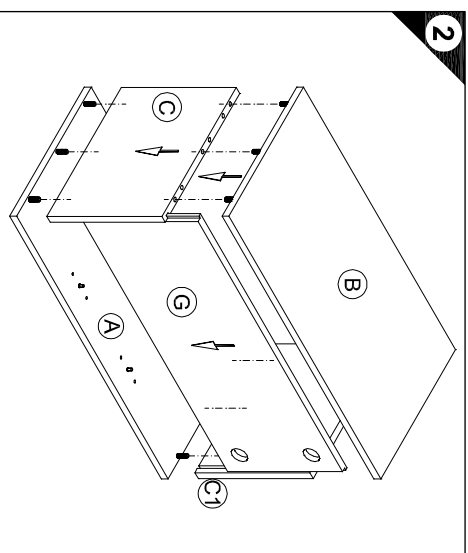
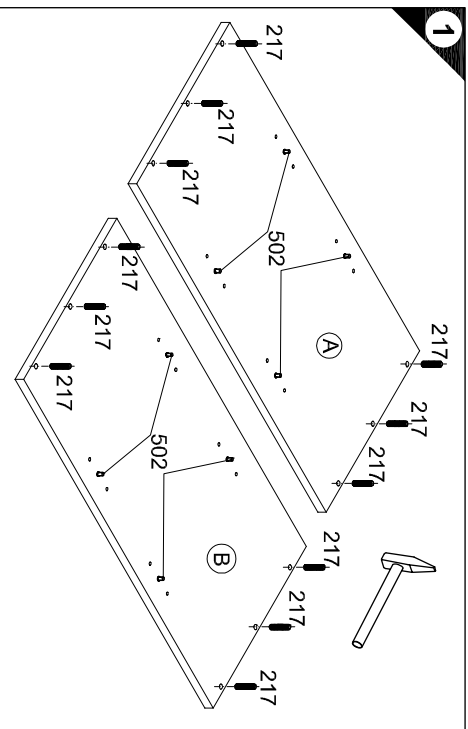
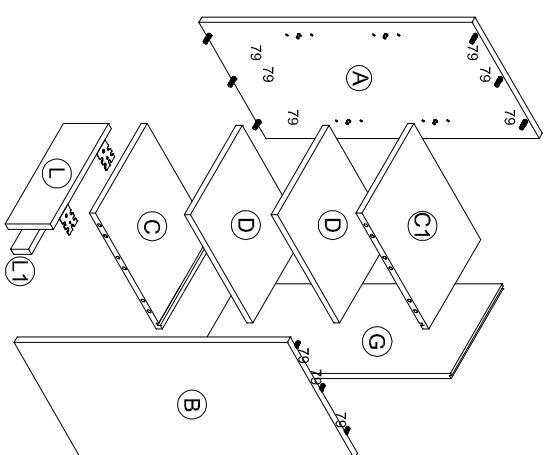
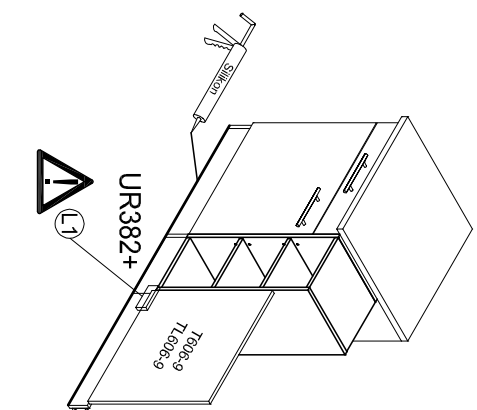
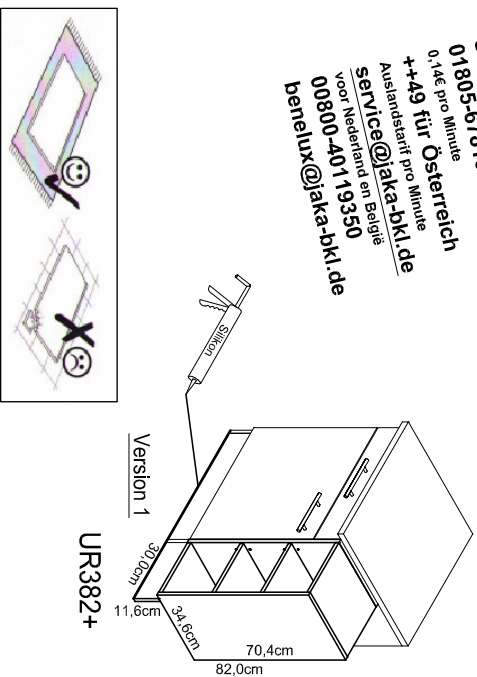

Ersatzteile/Spare parts/pièces de rechange/Reserveonderdelen/Piezas de recambio/Risambi/Запасные части/Części zamienne/óráalkatészék/Náhradní části/Надоместни дели/вароасат/резервделар

30cm UR382+ 30cm UR382+ / T606-9

A E940143 **B** E940143 **C** E940141 **D** E940145 **E** E940144 **F** E940139 **G** E940143 **H** E940143 **I** E940141 **J** E940141 **K** E940145 **L** E940144 **M** E940139 **N** E970977

500592.1.A 11/16 st

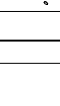
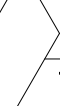
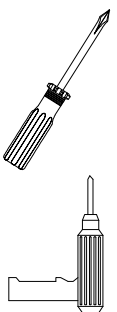

1

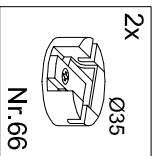

2x
Ø35

3

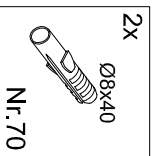

2x
Ø8x40

2

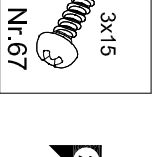

2x
Ø35

3

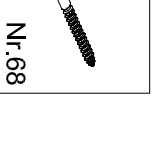

2x
Ø8x40

2

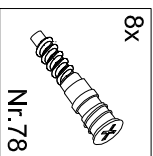

2x
Ø35

1

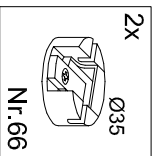

2x
Ø35

2

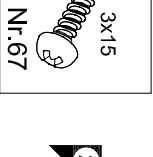

2x
Ø35

2

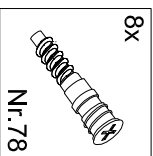

2x
Ø35

1

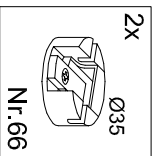

2x
Ø35

2

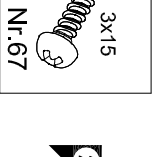

2x
Ø35

2

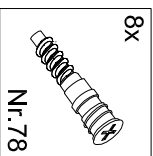

2x
Ø35

1

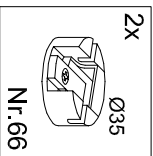

2x
Ø35

2

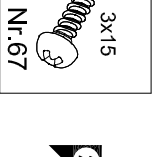

2x
Ø35

2

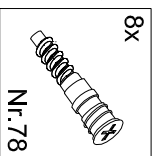

2x
Ø35

1

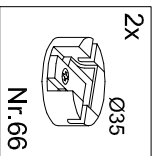

2x
Ø35

2

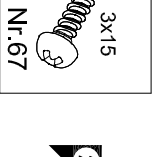

2x
Ø35

2

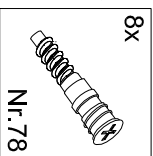

2x
Ø35

1

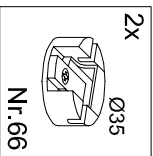

2x
Ø35

2

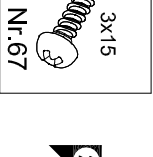

2x
Ø35

2

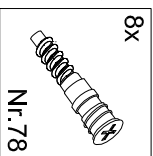

2x
Ø35

1

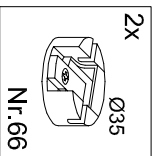

2x
Ø35

2

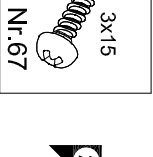

2x
Ø35

2

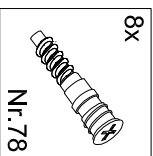

2x
Ø35

1

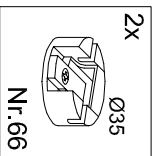

2x
Ø35

2

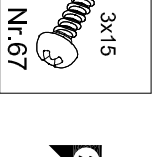

2x
Ø35

2

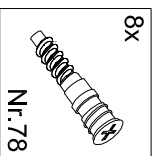

2x
Ø35

1

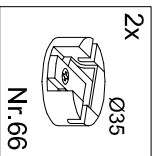

2x
Ø35

2

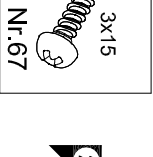

2x
Ø35

2

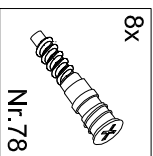

2x
Ø35

1

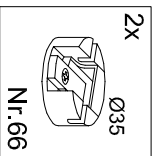

2x
Ø35

2

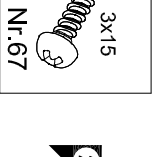

2x
Ø35

2

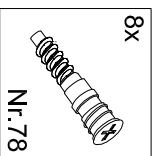

2x
Ø35

1

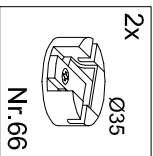

2x
Ø35

2

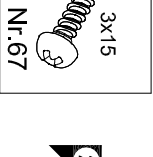

2x
Ø35

2

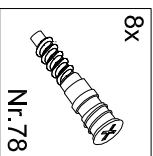

2x
Ø35

1

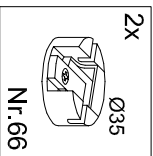

2x
Ø35

2

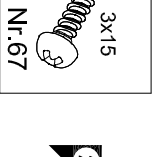

2x
Ø35

2

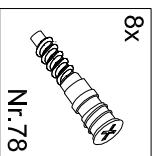

2x
Ø35

1

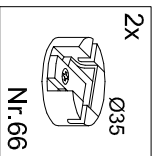

2x
Ø35

2

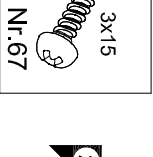

2x
Ø35

2

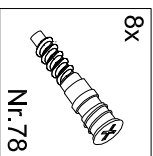

2x
Ø35

1

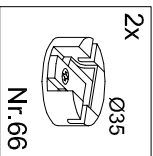

2x
Ø35

2

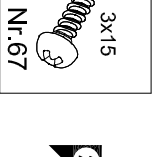

2x
Ø35

2

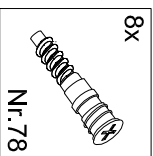

2x
Ø35

1

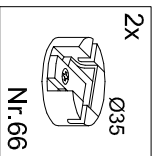

2x
Ø35

2

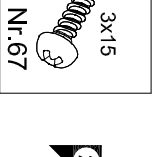

2x
Ø35

2

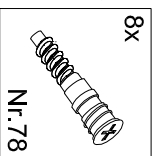

2x
Ø35

1

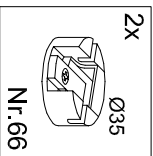

2x
Ø35

2

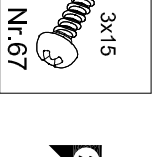

2x
Ø35

2

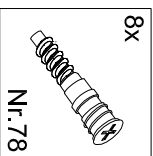

2x
Ø35

1

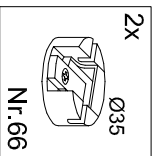

2x
Ø35

2

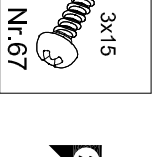

2x
Ø35

2

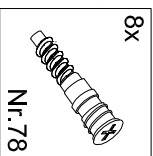

2x
Ø35

1

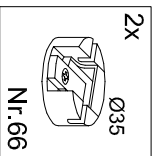

2x
Ø35

2

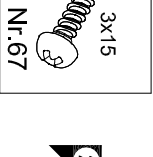

2x
Ø35

2

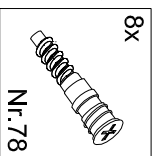

2x
Ø35

1

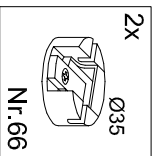

2x
Ø35

2

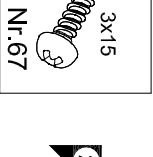

2x
Ø35

2

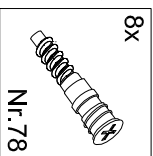

2x
Ø35

1

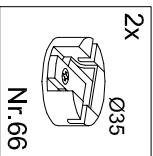

2x
Ø35

2

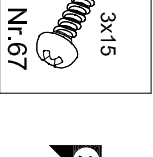

2x
Ø35

2

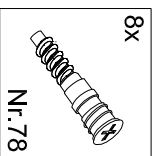

2x
Ø35

1

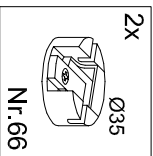

2x
Ø35

2

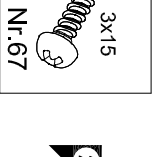

2x
Ø35

2

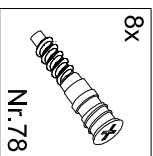

2x
Ø35

1

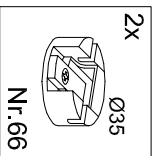

2x
Ø35

2

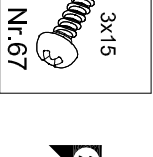

2x
Ø35

2

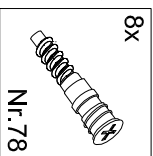

2x
Ø35

1

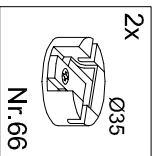

2x
Ø35

2

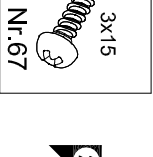

2x
Ø35

2

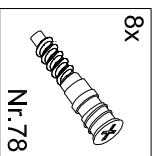

2x
Ø35

1

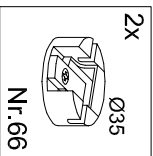

2x
Ø35

2

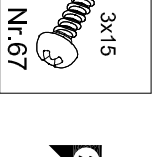

2x
Ø35

2

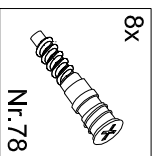

2x
Ø35

1

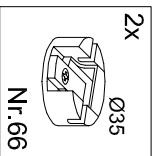

2x
Ø35

2

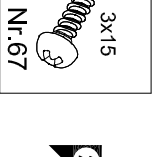

2x
Ø35

2

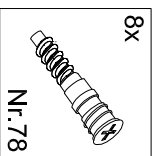

2x
Ø35

1

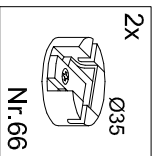

2x
Ø35

2

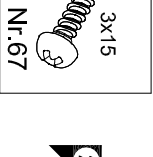

2x
Ø35

2

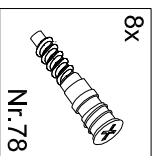

2x
Ø35

1

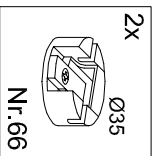

2x
Ø35

2

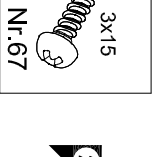

2x
Ø35

2

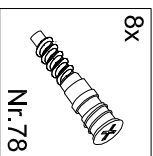

2x
Ø35

1

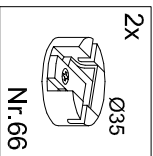

2x
Ø35

2

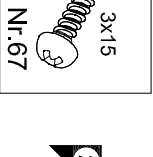

2x
Ø35

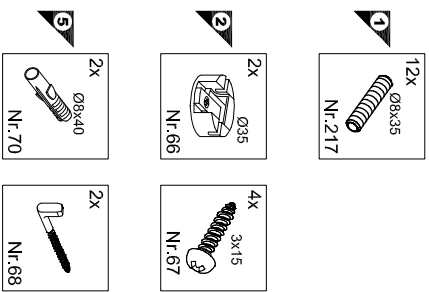
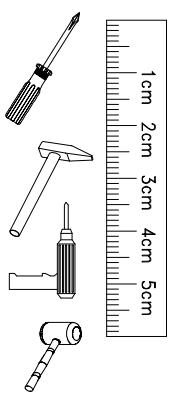

Montageanleitung

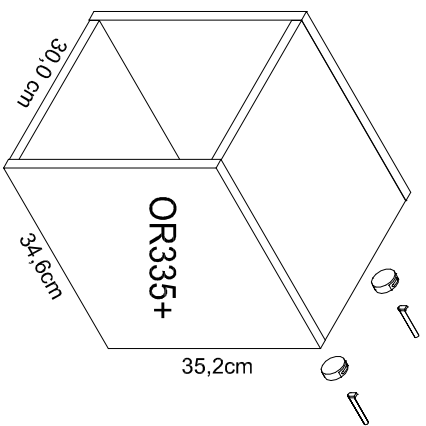

Service-Hotline
01 805-678101
0,14€ pro Minute
++49 für Österreich
Auslandsanruf pro Minute
service@jaka-bkl.de
voor Nederland en België
00800-40119350
benelux@jaka-bkl.de

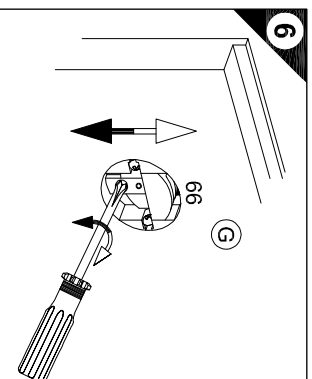
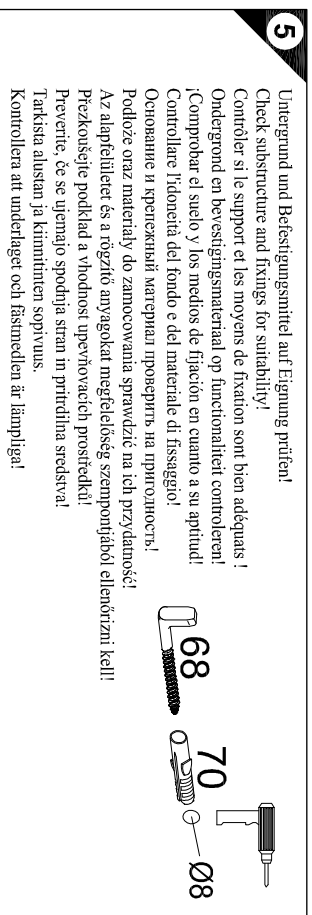
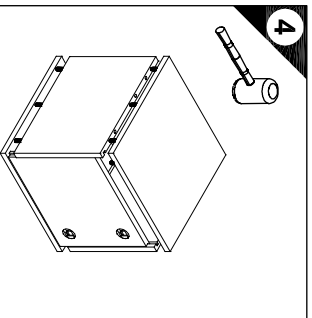
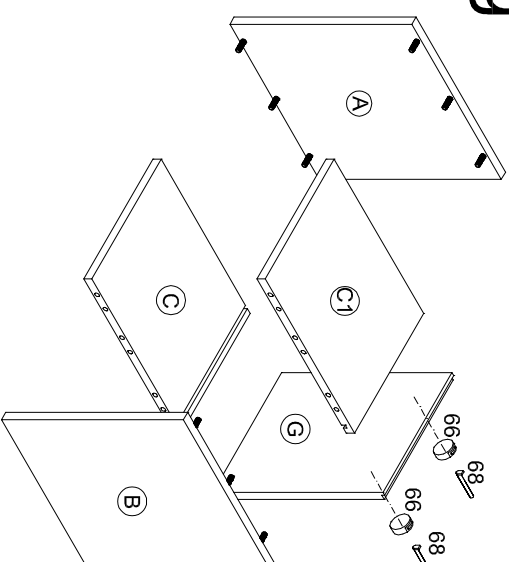
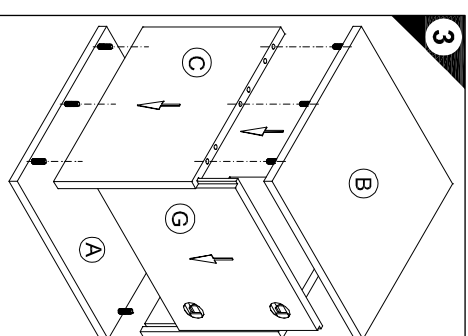
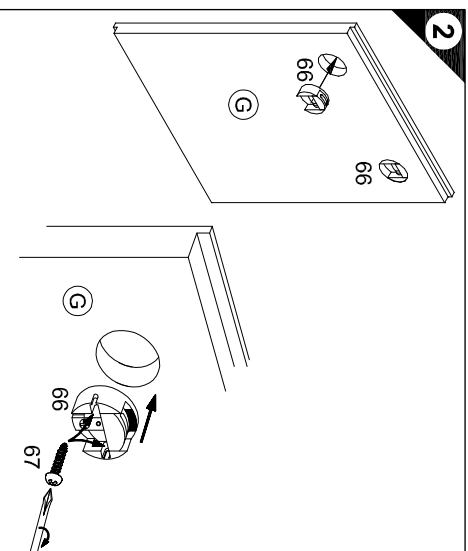
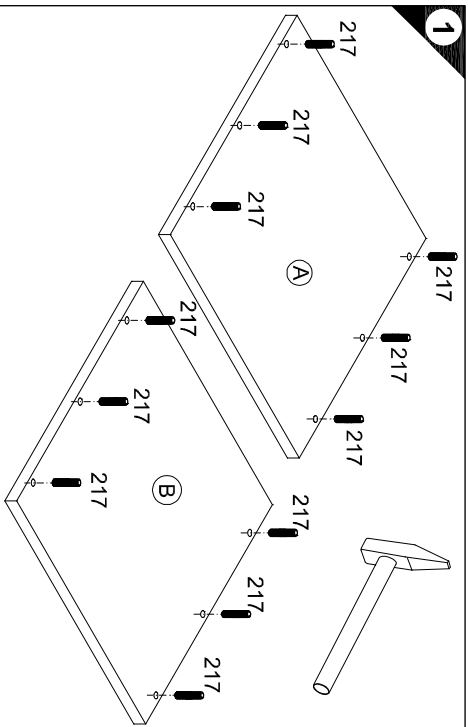

SERVICEKARTE

VH

Liebe Kundin, lieber Kunde,

obwohl wir unsere Möbel vor der Auslieferung einer eingehenden Endkontrolle unterziehen, kann es vorkommen, dass einmal ein Zubehörteil fehlt oder während des Transports beschädigt wird. Senden sie den Artikel bitte nicht zurück, sondern fordern sie einfach Ersatz für das Einzelteil bei unserer Kundenhotline an. Die Telefonnummern finden sie auf den Serviceseiten im Katalog.

Bitte benennen sie die Teile wie sie auf ihrer Aufbauanleitung angegeben sind. Fügen sie auch **Artikelnummer, Modellnamen und Farbnummer** bei. **Siehe Beispiel.**

Wir werden ihre Anforderung sofort bearbeiten und ihnen das Ersatzteil umgehend zusenden.

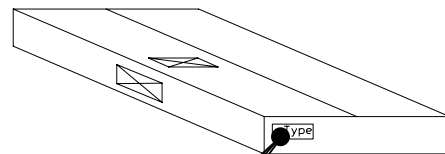
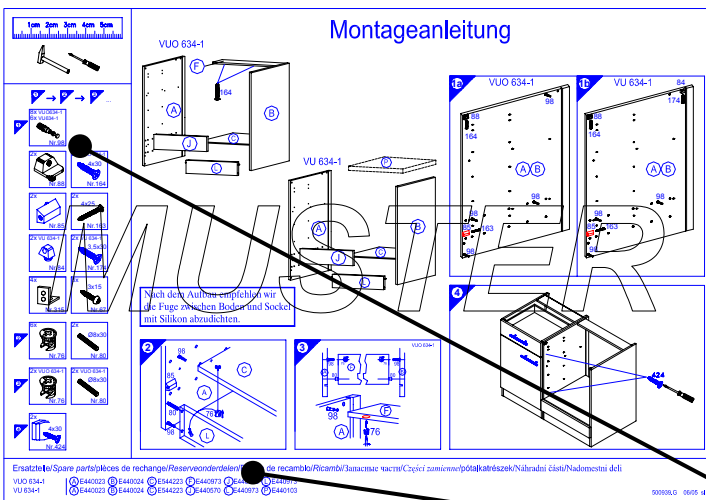

Muster - Bestellung		
Artikelnummer	123 456	
Modellname	Unterschrank VU634	
Farbe	TA 01	
Benötigte Ersatzteile:		
Bezeichnung	Nr.	Anzahl
Beschlagteil	98	2
Teil B	E 440 023	1

Bitte entnehmen sie die notwendige Ersatzteilnummer der Aufbauanleitung die zum Möbel gehört!

Kundendaten	
Kundennummer	
Name	
Vorname	
Strasse	
Haus-Nr.	
PLZ	
Ort	
Rechnungsdatum	
Tel. für Rückfragen	
Notizen:	

Ersatzteilbestellung		
Artikelnummer		
Modellname		
Farbe		
Benötigte Ersatzteile:		
Bezeichnung	Nr.	Anzahl
Grund der Ersatzteilanforderung:		

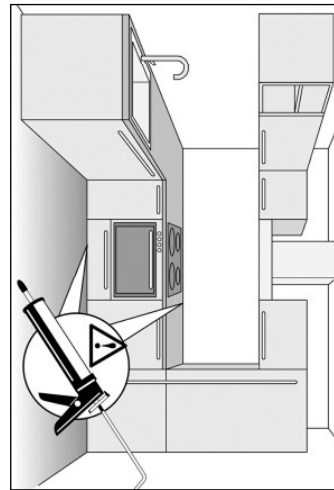
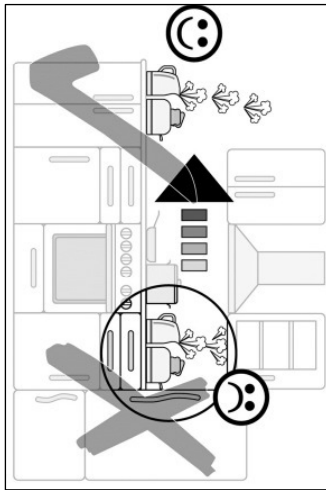
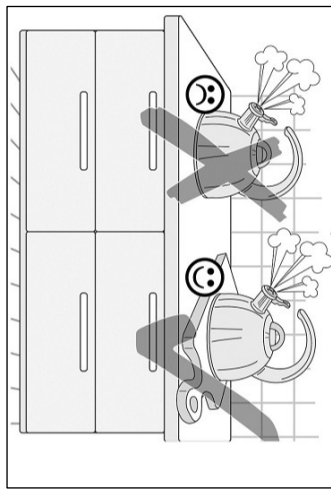
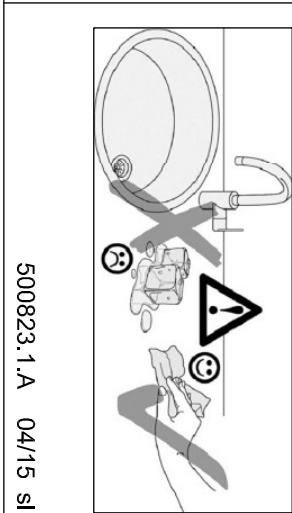
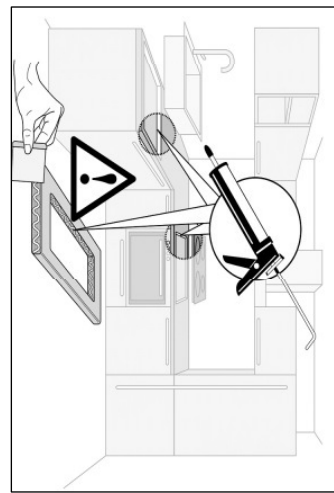
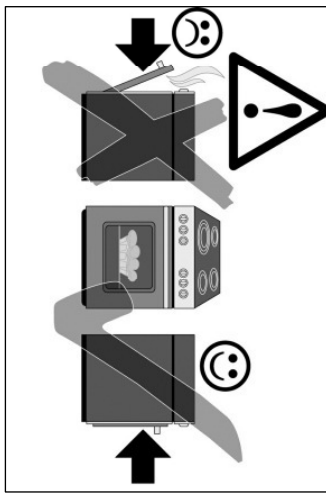
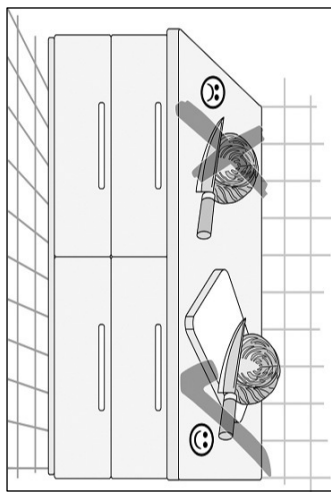
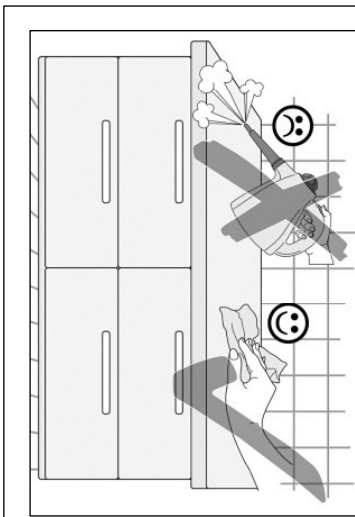

500823.1.A 04/15 SI

D Pflegehinweise

Kunststoff-Oberflächen:

Kunststoffbeschichtete Oberflächen/Fronten lassen sich mit haushaltsüblichen Reinigungsmitteln pflegen. Am besten geht das mit einem weichen Tuch, handwarmen Wasser und etwas Spülmittel. Verwenden Sie keine polierenden Reinigungsmittel oder harte Schwämme! Hartnäckige Flecken, wie Fettspritzer, Lack- oder Klebstoffreste, sind mit einem handelsüblichen Kunststoffreiniger zu beseitigen. Vor dem ersten Gebrauch dieser Mittel empfiehlt es sich, diese an einer nicht sichtbaren Stelle zu prüfen!

Glänzende Fronten: Diese Fronten nie trocken reinigen!
Die Verwendung von schleifenden Reinigungsmitteln (Mikrofaserlappen, Scheuerschwämme etc.) können zu erhöhter Bildung von Kratzern führen und sind kein Reklamationsgrund. Verwenden Sie daher am besten ein staubfreies Tuch oder ein feuchtes Fensterleder.

Einbauspülen und Herdmulden:

Einbauspülen, Herdmulden sowie alle nicht genannten Artikel aus rostfreiem Stahl pflegen Sie am besten mit einem Schwamm oder einem Vlies Tuch unter Verwendung von Spülmittel oder mit den bekannten Spezialpflegemitteln (Edelstahlreiniger, Metall-Polish). Bei Einbauspülen aus anderen Materialien wie Porzellan, Kunststoff, Acryl-Keramik sowie bei Edelstahlspülen milde Spül- oder Reinigungsmittel verwenden.

Bitte beachten Sie außerdem die speziellen Pflegehinweise der Hersteller!

Glaskeramik-Kochfelder:

Hartnäckige Verschmutzungen, Kalk- und Wasserflecken sowie glänzende Topfabrieb beseitigen Sie mit dem vom Hersteller empfohlenen Spezialreiniger (z.B. Cerafix, Stahlfix). Festgebrannte Verkrustungen (Zucker, Salz oder zuckerhaltige Speisereste) entfernen Sie, in noch heißem Zustand, mit einem Glasschaber.

Beachten Sie hierzu auch die Bedienungsanleitung des Geräteherstellers!

Griffe:

Verzichten Sie auf lösungsmittelhaltige und aluminiumschädigende Substanzen sowie auf Essigreiniger, da diese zu einer nicht mehr entfernbaren Fleckenbildung führen können.

GB Care instructions

Synthetic Surfaces:

Synthetic finishes on surfaces/fronts can be cared for with common household cleaners. It's best to use a soft cloth, hand warm water and a little washing-up liquid. Do not use any polishing cleaners or hard sponges! Stubborn marks, such as grease splashes, paint or adhesive residues can be removed with common, commercially available synthetic materials cleaners. However, it is recommended that these be tested on an inconspicuous area before using them for the first time!

Gloss Fronts: Never clean these fronts in the dry state!

Fitted sink units and all other articles made of stainless steel are best cleaned using a sponge or a fleece cloth with a washing-up liquid or known specialty cleaner (stainless steel cleaner, metal polish). Use mild washing-up or cleaning liquids on fitted sinks made of other materials, such as porcelain, synthetic material, acrylic ceramic as well as stainless steel. In addition, make sure to always follow the specific care instructions provided by the respective manufacturer!

Ceramic Glass Hobs:

Stubborn marks, limescale and water spots and shiny marks left by pots are best removed with special cleaners as recommended by the manufacturer. Use a glass scraper to remove burnt-on marks (sugar, salt or food spillages containing sugar) while still hot.

Please also refer to the operating instructions provided by the appliance manufacturer!

Handles:

Avoid using substances containing solvents or which are harmful to aluminium, as well as cleaners containing vinegar, as these can cause permanent discolouration.

NL Onderhoudsinstructies

Kunststof-opervlakken:

Oppervlakken/fronten met een kunststof coating kunnen met een gangbaar huishoudelijk reinigingsmiddel worden verzorgd. Dat gaat het beste met een zacht doekje, handwarm water en een beetje afwasmiddel. Gebruik geen polijstende reinigingsmiddelen of harde sponjes! Hardnekkige vlekken, resten van lak of lijm, moeten met een gangbaar reinigingsmiddel voor kunststof worden verwijderd. Voor het eerste gebruik van dit middel is het aan te bevelen om dit op een niet zichtbare plek uit te proberen!

Glänzende fronten: Deze fronten nooit droog reinigen!

Het gebruik van schurende reinigingsmiddelen (microvezeldoekjes, schuursponsjes etc.) kunnen tot snellere vorming van krasjes leiden en zijn geen reden voor een reclamatie. Gebruik daarom het beste een stofvrij doekje of een vochtige zeem.

Inbouwgootstenen en kookplaten:

Inbouwgootstenen, kookplaten en alle niet genoemde artikelen van roestvast staal reinigt u het beste met een sponsje of een vlieddoek met afwasmiddel of met de bekende speciale reinigers (vrs-reiniger, metaal-polish). Bij gootstenen van andere materialen zoals porselein, kunststof, acryl-keramiek en bij gootstenen van edelstaal milde afwas- of reinigingsmiddelen gebruiken. Neem bovendien de speciale reinigingsinstructies van de fabrikanten in acht!

Glaskeramische kookplaten:

Hardnekkig vuil, kalk- en watervlekken en glanzende slijtplekken van pannen verwijdert u met het door de fabrikant aanbevolen speciale reinigingsmiddel (bijv. Cerafix, Stahlfix). Aangekoekte en vastgebrande resten (suiker, zout of suikerhoudende voedselresten) verwijdert u, in nog hete toestand, met een glasschraper. Raadpleeg hiervoor ook de handleiding van de fabrikant van het apparaat!

Grepen:

Gebruik geen oplosmiddelhoudende en aluminium beschadigende substanties en geen schoonmaakazijn omdat deze tot vlekken kunnen leiden die niet meer te verwijderen zijn.

F Conseils d'entretien

Revêtements en plastique :

Les revêtements / fronts en plastique peuvent être entretenus au moyen d'un produit de nettoyage ménager courant. L'idéal est d'utiliser un chiffon doux, de l'eau tiède et un peu de produit pour la vaisselle. N'utilisez pas de produit de polissage ou d'éponges dures ! Éliminez les taches tenaces, telles que les projections de graisse et résidus de vernis ou de colle, au moyen d'un produit de nettoyage pour le plastique courant. Avant la première utilisation de ce produit, il est recommandé de tester celui-ci à un endroit dissimulé !

Fronts brillants : Ne nettoyez jamais ces fronts à sec !

L'utilisation de produits de nettoyage abrasifs (chiffons en microfibras, éponges abrasives, etc.) peut entraîner la formation accrue de rayures et ne peuvent justifier aucune réclamation. L'idéal est donc d'utiliser un chiffon non-pelucheux ou une peau de chamois humide.

Eviens encastrés et tables de cuisson :

Les éviens encastrés et tables de cuisson, ainsi que tous les éléments en acier inoxydable n'étant pas cités ici doivent être entretenus avec une éponge ou une peau de chamois, imprégnées de produit vaisselle ou d'un produit spécifique (détergent inox, polish métal). Les éviens encastrés fabriqués dans d'autres matériaux, tels que de la porcelaine, du plastique, de la céramique acrylique, ainsi que les éviens en acier inoxydable doivent être nettoyés au moyen de produit vaisselle ou détergent doux. Respectez également les consignes d'entretien spécifiques du fabricant !

Plaques vitrocéramiques :

Éliminez les taches tenaces, les taches de calcaire et d'eau, ainsi que les traces brillantes laissées par les casseroles au moyen du détergent spécial recommandé par le fabricant (par ex. Cerafix, Stahlfix). Éliminez les restes carbonisés (sucre, sel ou aliments sucrés) encore chauds au moyen d'un racloir. Respectez ici les instructions du fabricant de l'appareil !

Polignées :

N'utilisez pas de substances à base de solvant et détergent à l'aluminium ou produits à base de vinaigre ; ceux-ci peuvent causer des taches indélébiles.

IT Consigli di manutenzione

Superfici In materiale sintetico:

Le Superfici frontali rivestiti in plastica possono essere trattati con un comune detergente per la casa. È da preferir l'utilizzo di un panno morbido, acqua tiepida e detersivo per piatti.

Non utilizzare detergenti o spugne di tipo abrasivo! Le macchie più ostinate, come schizzi d'unto, residui di vernici o collanti possono essere rimosse con un comune detergente per superfici sintetiche, reperibile in commercio. Al primo utilizzo, si consiglia di provare il detergente su un punto non visibile della superficie!

Frontali lucidi: questo tipo di frontali non deve mai essere pulito da asciutto!

L'utilizzo di materiali abrasivi (panni in microfibra, pagliette ecc.) può aumentare il rischio di graffio delle superfici: la presenza di graffi non è da considerarsi motivo valido per alcun reclamo. Si consiglia l'utilizzo di un panno che non lasci pelucchi o di una pelle di daino umida.

Lavelli o piani cottura da incasso:

Per la manutenzione di lavelli, piani cottura o qualsivoglia altra unità in acciaio inox è consigliabile l'uso di una spugna o di un panno felpato, sapone per piatti o detergente specifico (detergente per acciaio, metallo).

Per la pulizia di lavelli in ceramica, in plastica o in acciaio, così come per quelli in acciaio è consigliabile l'uso di sapone per piatti o di un detergente delicato. Seguire inoltre i consigli per la manutenzione specifici, forniti dal produttore!

Piani cottura in vetro ceramica:

Le macchie più ostinate, il calcare, gli aloni creati dall'acqua, così come i segni lucidi lasciati dai tegami, possono essere rimossi con l'utilizzo di prodotti specifici, consigliati dallo stesso produttore (ad esempio Cerafix, Stahlfix). Qualsivoglia incrostazione (di zucchero, sale o di altri alimenti contenenti zucchero) potrà essere rimossa, a piano ancora caldo, con un raschietto per vetro. Seguire sempre le indicazioni del produttore!

Maniglie:

Evitare l'uso di prodotti contenenti solventi, che possano rovinare le superfici in alluminio o a base d'acetato, tali prodotti potrebbero infatti dar luogo a macchie permanenti.

CZ Pokyny pro ošetřování

Plastové povrchy:

Plastem potažené povrchy/čela lze ošetřovat běžnými čistícími prostředky pro domácnost. Nejlépe provedete ošetření měkrou utěrkou a vlažnou vodou s malým množstvím mycího prostředku. Nepoužívejte lešticí čistící prostředky nebo tvrdé mycí houby! Ulpělé fleky, jako skvrny od vystříknutého tuků, zbytků laku nebo lepidla je nutné odstranit běžným čistícím prostředkem na plasty. Před prvním použitím těchto prostředků se doporučuje je vyzkoušet na místě, které není viditelné!

Lesklé čelní plochy: Tato čela nikdy nečistěte nasucho!

Používání abrazivních čističích prostředků (úterky z mikrovlákna, drhoucích mycích houbiček atd.) mohou vést ke zvýšené tvorbě škrábanců a nejsou důvodem k reklamaci. Používejte proto nejlépe bezprašnou utěrku nebo vlhkou kůži na okna.

Vestavné dřezy a varné desky:

Vestavné dřezy, zaschlé skvrny usazenin a vody, jakož i všechny neuvedené artikly z nerezové oceli ošetřujte nejlépe houbičkou nebo utěrkou z netkané textilie s použitím mycího prostředku nebo se známými speciálními ošetřujícími prostředky (čistící prostředek na uslechtilou ocel, lešticí prostředky na kov). U vestavných dřezů z jiných materiálů jako porcelánu, plasty, akrylátové keramiky, jakož i u dřezů z nerezové oceli používejte jemné mycí nebo čistící prostředky. Dbejte kromě toho na speciální pokyny pro ošetřování od výrobce!

Sklokeramické varné desky:

Ulpělé nečistoty, zaschlé skvrny usazenin a vody, jakož i lesklé stopy po otěru hrdí odstraňujte výrobcem doporučenými speciálními čistídy (např. Cerafix, Stahlfix). Pevně zabezčené nánosy (cukr, sůl nebo zbytky jídla, obsahující cukr) odstraňujte ještě horké přiloženou skleněnou škrabkou. Dbejte přitom také na návod k obsluze výrobce přístroje!

Madla: Nepoužívejte látky obsahující rozpouštědla a poškozující hliník, jakož i čistidla obsahující ocet, protože to může vést ke vzniku neodstranitelných fleků.

HU Ápolási tudnivalók

Műanyagfelületek:

A műanyag bevonatú felületek/frontok ápolása szokványos háztartási tisztítószerrel lehetséges. A legjobb a puha törökendő, langyos víz és némi mosogatószer használata. Ne használjon porlózó hatású tisztítószert vagy kemény szivacsot!

A makacs foltok – pl. ráfröccsent zsír, lakk- vagy ragasztómaradványok – kereskedelemben kapható műanyagtisztítóval távolíthatók el. Az ilyen tisztítószernek első használata előtt ajánlott próbát végezni egy nem látható helyen!

Fényes frontok: Az ilyen frontokat soha ne tisztítsa szárazon!

A súroló hatású tisztítószernek és -eszközök (mikroszálás törökendők, súrolószivacsok stb.) használata fokozott karcosodást okoz, amit nem áll módunkban reklamálni alapjául elfogadni.

Ezért a legjobb, ha pormentes törökendőt vagy abszorbáló törökendőt használ.

Beépített mosogatók és főzőlapok:

A rozsdamentes acélból készült beépített mosogatók, főzőlapok és egyéb meg nem nevezett termékek ápolásának legkíméletesebb módja a szivacs vagy gyapjúkendő és némi mosogatószer vagy valamelyik ismert speciális ápolóser (nemesacél tisztító, Metall Polish) használata. Más anyagokból – pl. porcelán, műanyag, akril-kerámia – vagy nemesacélból készült beépített mosogatókhoz kímélő mosogató- vagy tisztítószert használjon.

Kérjük, hogy ezenkívül a speciális gyártói ápolási tudnivalót is vegye figyelembe!

Üvegkerámia főzőlapok:

A rozsdamentes acélból készült beépített mosogatók, főzőlapok és egyéb meg nem nevezett termékek ápolásának legkíméletesebb módja a szivacs vagy gyapjúkendő és némi mosogatószer vagy valamelyik ismert speciális ápolóser (nemesacél tisztító, Metall Polish) használata. Más anyagokból – pl. porcelán, műanyag, akril-kerámia – vagy nemesacélból készült beépített mosogatókhoz kímélő mosogató- vagy tisztítószert használjon.

Kérjük, hogy ezenkívül a speciális gyártói ápolási tudnivalót is vegye figyelembe!

Fogantűk:

Ne használjon oldószert tartalmazó és alumíniumot károsító anyagokat, továbbá ecetes tisztítószert, mert ezek maradandó foltosodást okozhatnak.

TR Bakım uyarıları

Plastik yüzeyler:

Plastik kaplı yüzeyler/ön paneller sıradan temizlik maddeleriyle temizlenebilir. Bunun için yumuşak bir bez, ılık su ve biraz deterjan kullanın. Parlaklı temizlik maddeleri veya sert süngerler kullanmayın! Yağ artıkları, boya veya yapışkan artıkları gibi zor lekeler i sıradan bir plastik temizleyicikle temizleyin. Bu maddeleri ilk kez kullanmadan önce bunları önce görünmeyen bir yerde test etmeniz öneriyoruz!

Parlak ön paneller: Bu panelleri asla kuru şekilde temizlemeyin!

Aşındırıcı temizlik maddelerinin kullanılması (mikro elyaflı bezler, bulaşık tell vs.) daha fazla çizilge neden olurlar ve şikayet nedeni olarak geçerli değildirler. Bu nedenle tozsuz bir bez veya nemli bir güdelti bez kullanın.

Ankastre evye ve ocak gözleri:

Ankastre evyeler, ocak gözleri ve paslanmaz çelkten yapılmış bahşi geçmeyen diğer ürünler bir süngerle veya bir keçeyle bezlerle temizlenir kullanarak temizleyin (paslanmaz çelik temizleyici, Metall-Polish). Porselen, plastik, akril seramik gibi maddelerden yapılmış evyelerde ve paslanmaz çelik evyelerde yumuşak deterjan kullanın.

Аyrıca üreticinin özel bakım uyarılarını dikkate alın!

Cam seramik ocaklar:

Zorlu kirlet, kireç ve su lekelerini üreticinin tavsiye ettiği mzel temizleyicikle temizleyin (ör. Cerafix, Stahlfix). Yanmış kirler (şeker, tuz veya şeker içeren yemek artıkları) sıcak durumdayken bir cam raspayla çıkarın. Bununla ilgili cihaz üreticisinin kullanım kılavuzunu dikkate alın!

Tutamaklar:

Solvent madde içeren, alüminyuma zarar veren maddelerden, sıkke içeren maddelerden kaçının; bunlar kalıcı lekelere yol açabilirler.

PL Wskazówki do pielęgnacji

Powierzchnie z tworzyw sztucznych:

Powierzchnie powlekane tworzywami sztucznymi można pielęgnować zwykłymi środkami myjącymi, jakie są używane w gospodarstwie domowym. Najlepiej nadaje się do tego miękka ścierečka, letnia woda i nieco środka myjącego. Nie używać środków do polerowania ani twardych gąbek! Uporczywe plamy, np. tłuszczu, resztki lakieru lub taśmy klejącej, usuwać dostępnymi w handlu środkami do czyszczenia tworzyw sztucznych. Przed pierwszych ich użyciem zaleca się wypróbowanie w niewidocznym miejscu!

Strony czolowe z polysklem: Tych części nigdy nie czyścić na sucho!

Używanie ściągających środków czyszczących (ściereczki z mikrofazy, gąbki do szorowania itd.) może prowadzić do nasilonego powstawania rys i nie stanowi podstawy do reklamacji. Dlatego najlepiej jest stosować ściereczkę wolną od pytu lub wilgotną skórę do czyszczenia okien.

Wbudowywane zlewozmywaki i wnęki kuchenne:

Wbudowywane zlewozmywaki, wnęki kuchenne, jak też wszystkie niewymienione artykuły ze stali nierdzewnej najlepiej jest pielęgnować gąbką lub ściereczką z włókniny i płysmem do mycia lub znanym środkiem specjalnym do pielęgnacji (do czyszczenia stali szlachetnej, polerowania metali). W przypadku zlewozmywaków z innych materiałów, jak porcelana, tworzywo sztuczne, ceramika akrylowa lub ze stali szlachetnej stosować łagodne środki myjące lub czyszczące. Prosimy poza tym stosować się do szczególnych instrukcji producenta!

Ceramizna płyta kuchenna:

Uporczywe zabrudzenia, osady kamienia i zacieki jak też blyszące odbicie garnków usuwać specjalnym środkiem zalecanym przez producenta (np. Cerafix, Stahlfix). Nadpalone resztki (cukier, sól, resztki zawierające cukier) usuwać, w stanie jeszcze gorącym, dołączonym skrobakiem szklanym.Stosować się przy tym także do Instrukcji producenta urządzenia!

Uchwyty:

Zrezygnować z substancji zawierających rozpuszczalniki i szkodliwych dla aluminium, jak też na bazie octu, gdyż mogą one prowadzić do powstawana nieusuwalnych plam.

SK Pokyny k údržbe

Povrchy z umelých hmoty:

Povrchy z umelých úpravou z umelej hmoty/čelné plochy je možné ošetrovať pomocou čistiacich prostriedkov bežných v domácnosti. Najlepšie to ide mäkkou handričkou, vlažnou vodou a nepatrným množstvom prostriedku na umývanie. Nepoužívajte leštiliace čistiace prostriedky ani tvrdé špongie!

Zatvrdnuté skvrny, ako rozstreky oleja, zvyšky laku alebo lepidla, sa musia odstrániť pomocou čistiacich prostriedkov bežných v domácnosti. Pred prvým použitím týchto prostriedkov sa odporúča prekontrolovať pôsobenie na nejakom mieste, ktoré nie je vidieť!

Lesklé čelné plochy: Tieto čelné plochy nikdy nečistíte nasucho!

Použitie brúsiačich čističích prostriedkov (úterky z mikrovlákna, špongie na drhnutie atď.) môžu viesť ku zvýšenému tvoreniu škrabancov a tieto nie je dôvodom na reklamáciu. Preto používajte handričky bez prflomnosti prachu alebo vlhkú kožu na čistenie skiel.

Vstavané umývadlá a sporáky:

Vstavané umývadlá, sporáky, ako aj všetky neuvedené výrobky z nehrdzavjúcej ocele ošetríte pomocou špongie alebo úterky z rúna za použitia prostriedku na umývanie alebo pomocou známych špeciálnych čistiacich prostriedkov (čistiaci prostriedok na usťahčtilú oceľ, polítúra na kov). Pri vstavanych umývadlách z iných materiálov, ako porcelán, umelá hmota, akryl keramiká, ako aj pri umývadlách z usťahčtiljej ocele používajte jemné čistace prostriedky alebo prostriedky na umývanie.

Okrem toho dodržiavajte špeciálne pokyny k ošetrovaniu od výrobcu!

Sklokeramické platne:

Zatvrdnuté znečistenia, fleky z vodného kameňa a vody, ako aj lesklý odtér z hrncov odstraňujte pomocou špeciálneho čistíča odporúčaného výrobcou (napr. Cerafix, Stahlfix). Zapečené inkrustácie (cukor, soľ alebo zvyšky jedla s obsahom cukru) odstraňujte ešte v horúcom stave pomocou prílozenej škrabky na sklo.

Prihladajte pritom aj na návod na obsluhu od výrobcu spotrebiča!

Úchyty:

Zrekltnite sa substancií s obsahom rozpúšťadla a substancií poškozujúčich hliník, ako aj octových čistiacich prostriedkov, pretože tieto môžu viesť k už neodstraniteľným škvrám

RO Indicații de îngrijire

Suprafețe din plastic :

Suprafețele/suprafețele frontale cu strat de acoperire din plastic pot fi îngrijite cu agenți de curățare casnici uzuali. Cea mai bună soluție este cu o cârpă moale , apă caldă și puțin detergent. Nu utilizați substanțe de curățare abrazive sau bureți tari ! Petele persistente, cum sunt stropii de uscare, resturile de vopsea sau adeziv, se vor înlătura cu un detergent uzual din cu mert pentru plastic. Înainte de prima utilizare a acesteii substanțe, se recomandă verificarea ei într-un loc mai puțin vizibil !

Suprafețe frontale strălucitoare : Nu curățați niciodată uscat celește suprafețe fronta le!

Utilizarea unor mijloace abrazive de curățare (cârpă cu microfibre, bureți pentru frecat etc.) pot duce la formarea unor zgârieturi și nu constituie un motiv pentru reclamații . De aceea, cel mai bine este să curățați cu o cârpă moale, să nu faceți praf sau o bucată umedă de piele pentru geamuri .

Chiuvele Incorporate și locașur pentru plite:

Chiuvelele Incorporate, locașurile pentru plite, precum și toate articolele care nu sunt menționate din oțel inoxidabil și fi îngrijite optim cu un burete sau cu o cârpă textilă, utilizând un agent de spălare sau agenții de îngrijire cunoscuți (detergenți pentru inox, agenți de lustruț metale). În cazul chiuvelor încorporate din alte materiale cum sunt porțelanul, plasticul, ceramica acrilică, precum și în cazul chiuvelor din inox, utilizați agenții de spălare sau de curățare neagresivi .

Vă rugăm să acordați atenție, suplimentar, indicațiilor speciale de îngrijire emise de producător !

Ochiluri de plită din sticlă ceramcă :

Murdăria persistentă , petele de calcar și apă, precum și urmele strălucitoare lăuate de vase se înlătură cu agenții de curățare special recomandați de producător (de ex. Cerafix, Stahlfix). Crusteje aderente de arsuri (zahăr, sare sau resturi de alimente care conțin zahăr) se înlătură în starea încă fierbinte cu o racletă pentru sticlă .

În acest sens, respectați manualul de utilizare editat de producătorul aparatului !

Măner:

Ne recomandați la substanțele care conțin solventi și care deteriorează aluminiul, precum și la substanțele de curățare pe bază de oțel , deoarece acestea pot forma pete care nu se mai înlătură .