

Variabler ECKEINSTIEG Trento

Maße: 900 x 900 x 1800 mm

B8090 – 51194155 / 33331037
 B8090WS – 70567511 / 39956613
 B8090C – 68165331 / 28384669
 B8090CS – 13717463 / 21371865
 B8090B – 46713949 / 42547161
 B8090BS – 86067306 / 75104752

D

**Aufbauanleitung
 Duscheeckestieg**

I

**Istruzioni d'installazione
 Entrata ad angolo per doccia**

GB

**Installation Instruction
 Square Shower**

NL

**Montagehandleiding
 Hoekinstap douche**

F

**Instructions d'installation
 Cabine de douche accès d'angle**

D: Nachdruck, auch auszugsweise, nicht gestattet! GB: Reproduction, even in extracts, is not permitted! F: Toute reproduction de ce mode d'emploi même par extraits est interdite ! IT: È vietata la riproduzione, anche parziale. NL: Nadruk, ook slechts gedeeltelijk, niet toegestaan!

Anleitung, Nr.: 20160356

WICHTIG, FÜR SPÄTERE BEZUGNAHME DIESES DOKUMENT
AUFBEWAHREN! SORGFÄLTIG LESEN!

Bestimmungsgemäßer Gebrauch

- Dieser Artikel ist eine vorgefertigte Einheit zum Duschen.
- Dieser Artikel ist nur zum Einsatz im privaten Bereich bestimmt.



Sicherheitshinweise

- Erstickungs- / Verletzungsgefahr! Lassen Sie Kinder nicht mit der Verpackung spielen. Sie könnten an der Folie ersticken oder sich an der Umverpackung verletzen.
- Achten Sie darauf, dass Kinder keine kleinen Teile, wie z. B. Muttern, Abdeckkappen oder Ähnliches in den Mund nehmen. Sie könnten sie verschlucken und daran ersticken.
- Beschädigungsgefahr! Vor der Montage bitte Montageanleitung genauestens durchlesen und Produkt auf evtl. Transportschäden überprüfen. Gehen Sie bei der Montage des Artikels sorgfältig vor.
- Der Artikel darf nur von fachkundigen Personen montiert werden. Es empfiehlt sich die Montage mit zwei Personen durchzuführen.
- Verletzungsgefahr! Beachten Sie bei der Montage, dass einige Teile scharfe Kanten aufweisen.
- Montieren Sie den Artikel nur an einer geeigneten, massiven Wand.
- **Achtung:** Die Befestigung des Möbelstückes an der Wand muss von einer fachkundigen Person vorgenommen werden, da für die Montage an die Wand angepasste Dübel erforderlich sind.
- Stellen Sie sicher, dass sich keine Kabel oder Rohrleitungen in den Bohrbereichen befinden
- Prüfen Sie die Bereiche vor dem Bohren mit einem Metallsuchgerät.
- Gehen Sie mit den Glasfläche behutsam um! Halten Sie die Glasfläche beim Einbau gut fest, damit sie nicht herunterfallen.
- Dichten Sie die Duschatrennung von außen mit Silikon ab. Benutzen Sie die Dusche erst 24 Stunden nach dem Abdichten.
- Zum Anschluss der Wanne an die hauseigene Wasserentsorgung sollte ein handelsüblicher Syphon mit einem flexible Abwasserschlauch verwendet werden.
- Bei Ersatzteilbestellung (siehe Teileliste) bitte an den Kundenservice wenden.

Pflegehinweise

Reinigen Sie die Glasfläche mit einem feuchten Tuch und etwas Glasreiniger und wischen Sie mit einem trockenen Tuch nach. Es genügen umweltschonende und sanfte Haushaltsreiniger. Verwenden Sie keinesfalls aggressive oder Lösemittel enthaltende Reinigungsmittel. Benutzen Sie zur Reinigung auf keinen Fall scharfe Gegenstände, Stahlwolle, Chemikalien oder sandhaltige Scheuermittel. Diese führen zu einer Beschädigung der Oberfläche und zu einem Verlust der Garantie. Leichte Kalkbeläge lassen sich mühelos mit etwas Haushaltessig entfernen.

Benötigte Werkzeuge

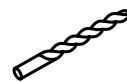
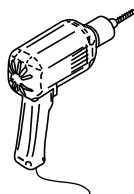
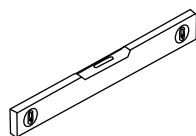
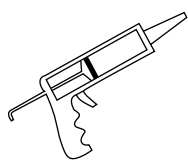

Ø 6mm

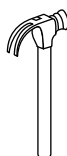
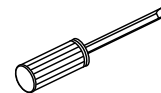

Ø 3.2mm

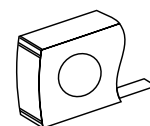
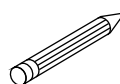
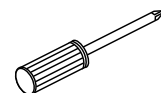

**Aufgrund des hohen Gewichts dieses Produktes
könnte der Aufbau zwei Personen erfordern.**

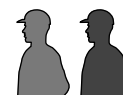

Verpackungsinhalt

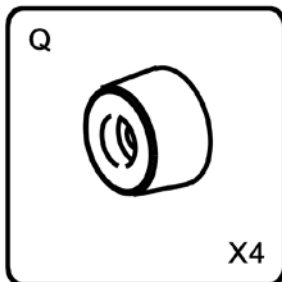
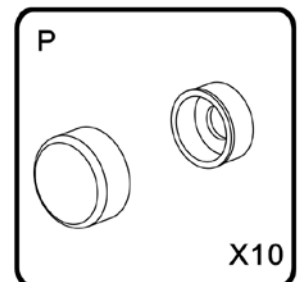
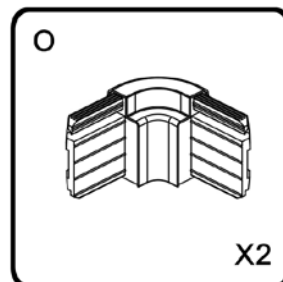
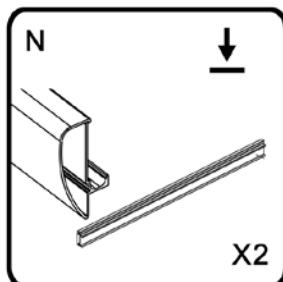
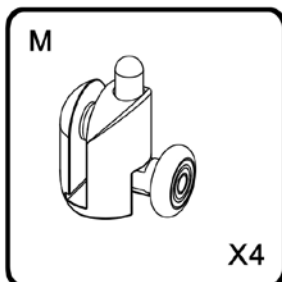
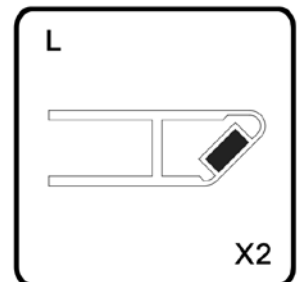
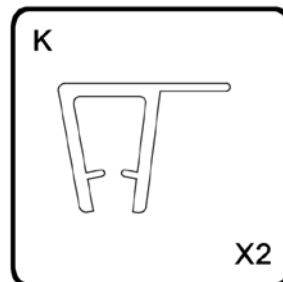
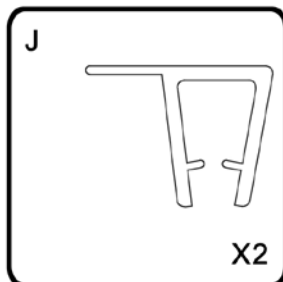
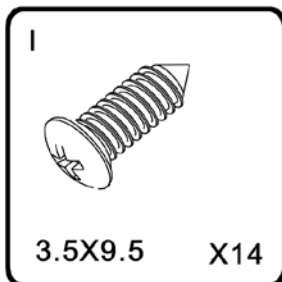
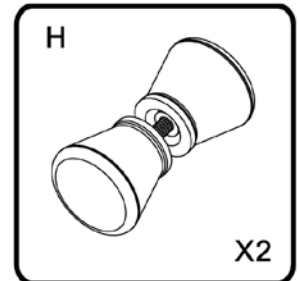
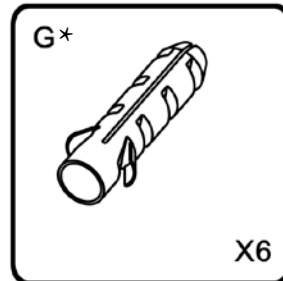
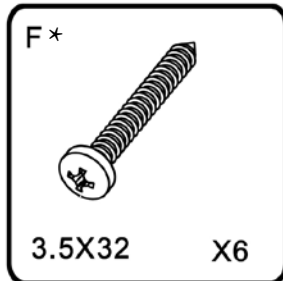
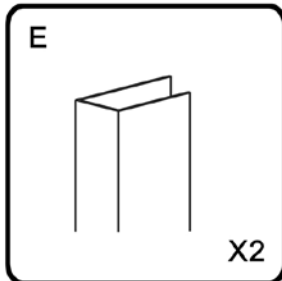
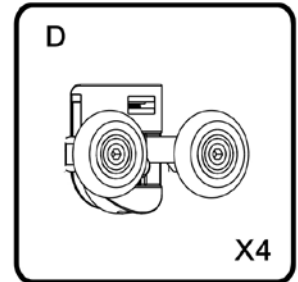
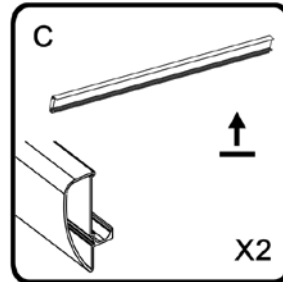
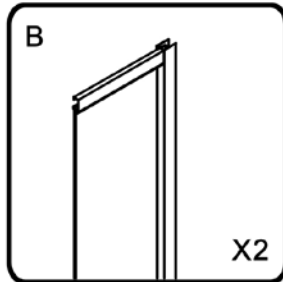
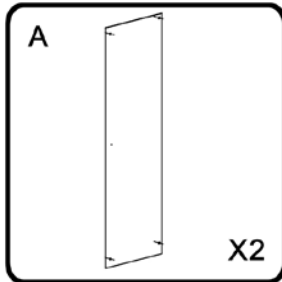
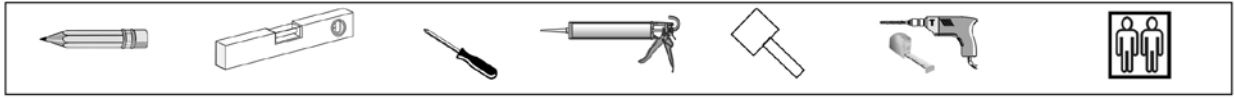

* nicht enthalten

Montagezeichnung

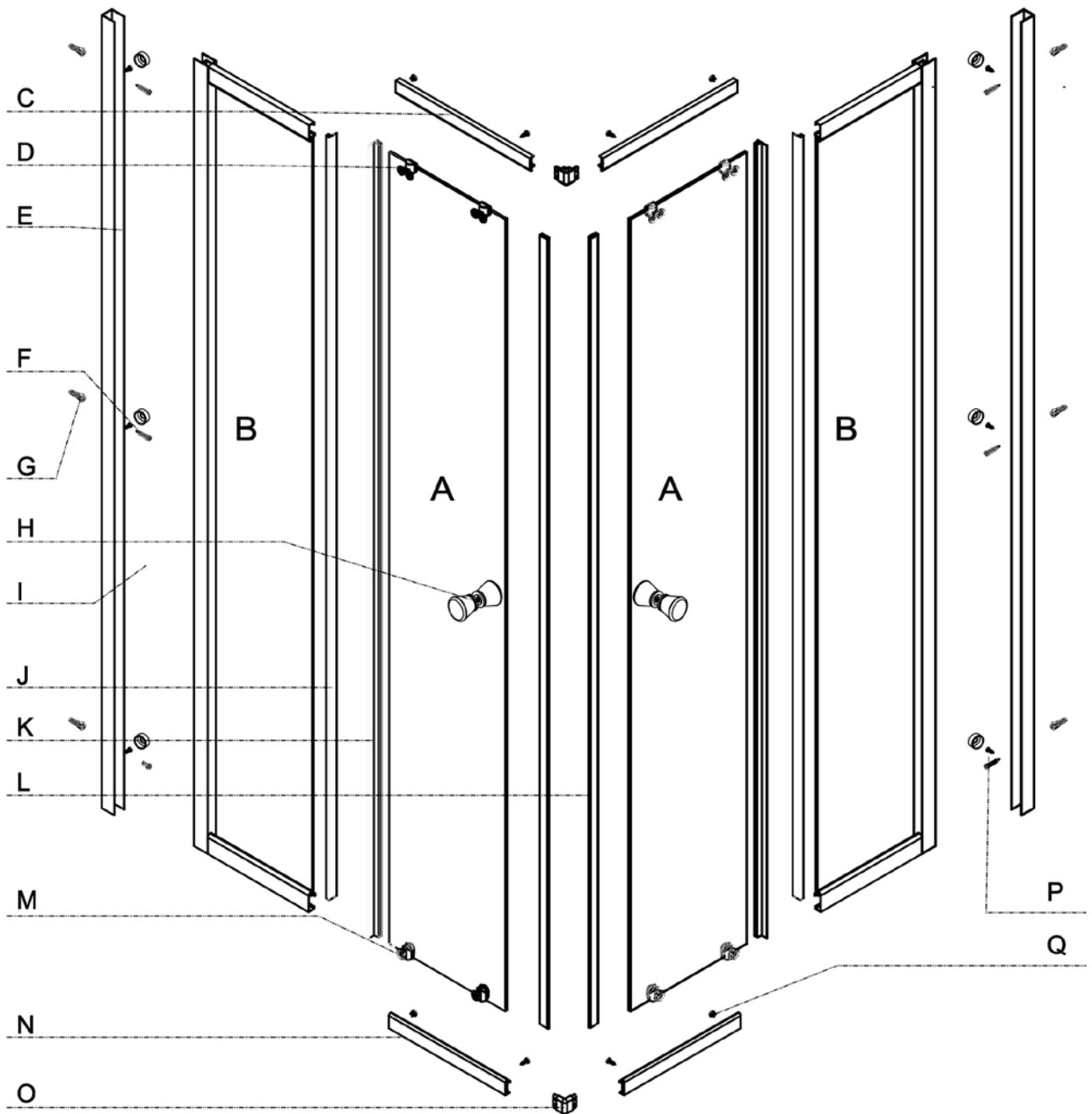

Aufbauschritte



* nicht enthalten

Schritt 1

- Die Wanne ist an senkrechten Wänden in einem 90 Grad Winkel auszurichten, mittels einer Wasserwaage.
- Die Fugen sind mit Silikon auszuspritzen. Das Silikon ist entsprechend den eingesetzten Baumaterialien auszuwählen, beachten Sie die Aushärtezeiten.

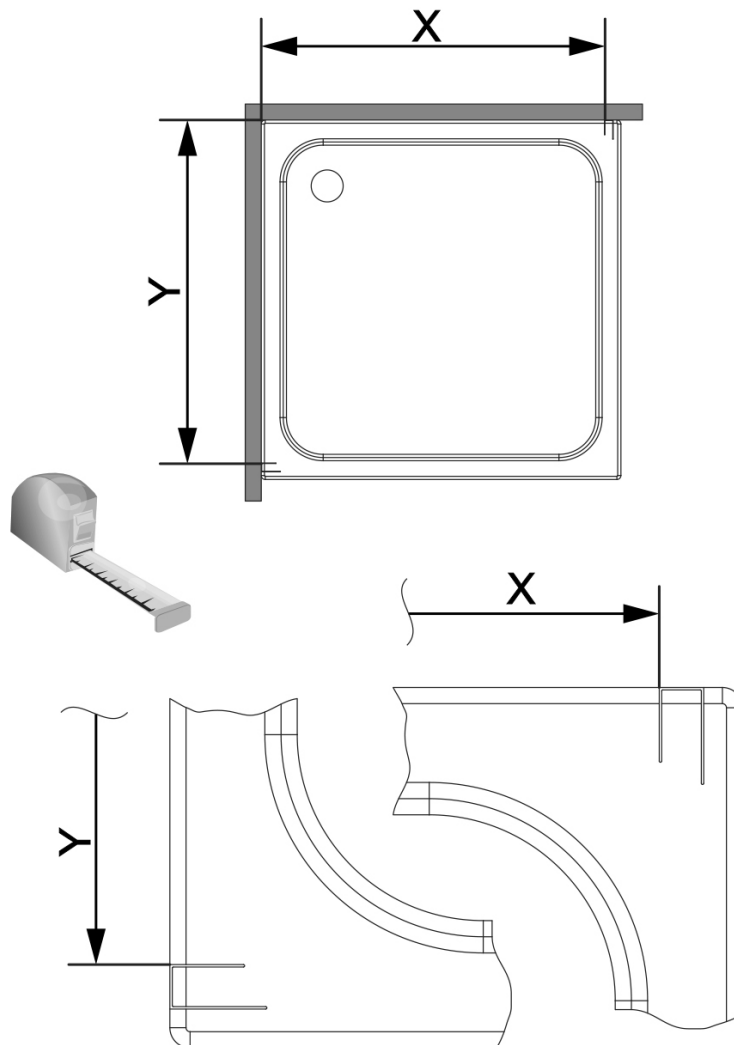

Schritt 2

Richten Sie den Rahmen mit der Wasserwaage aus. Zeichnen Sie die Befestigungslöcher an. Montieren Sie den Rahmen, wie in den Piktogrammen aufgezeigt, an die Wand.

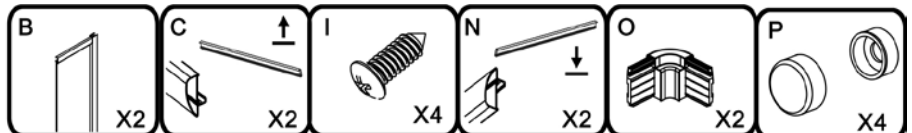
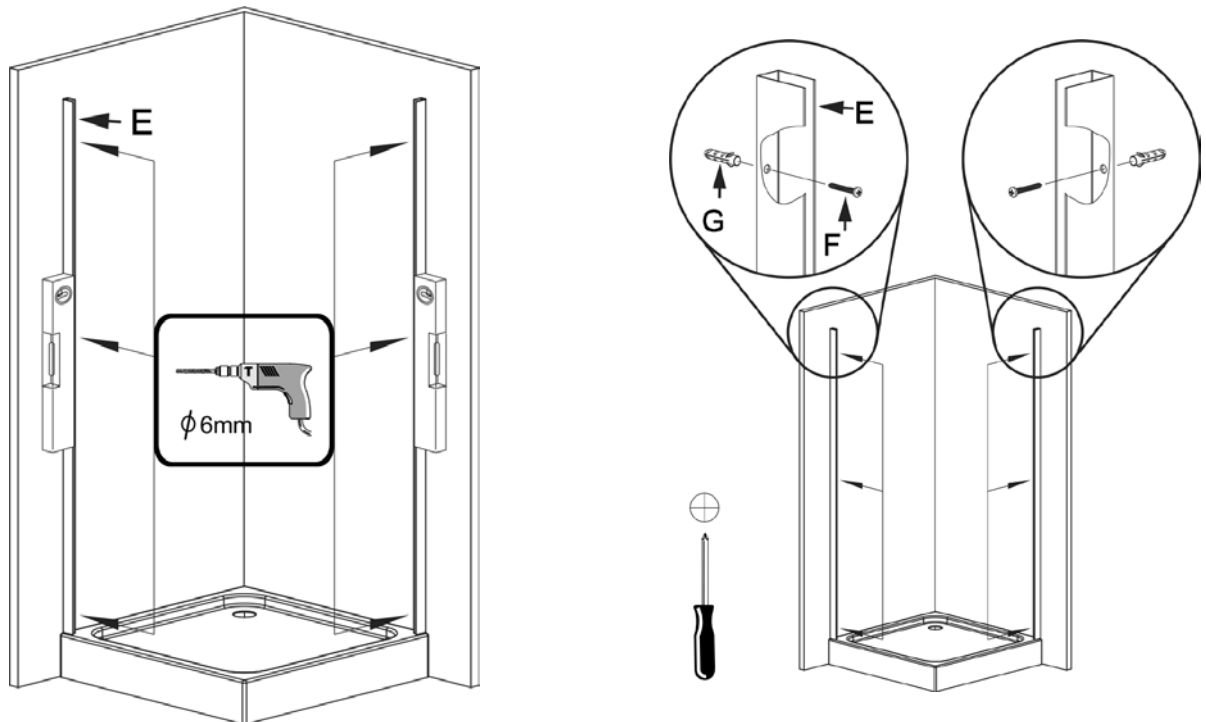

Schritt 3

Stecken Sie die Eckverbindungen entsprechend zusammen und verschrauben diese für unten und oben.

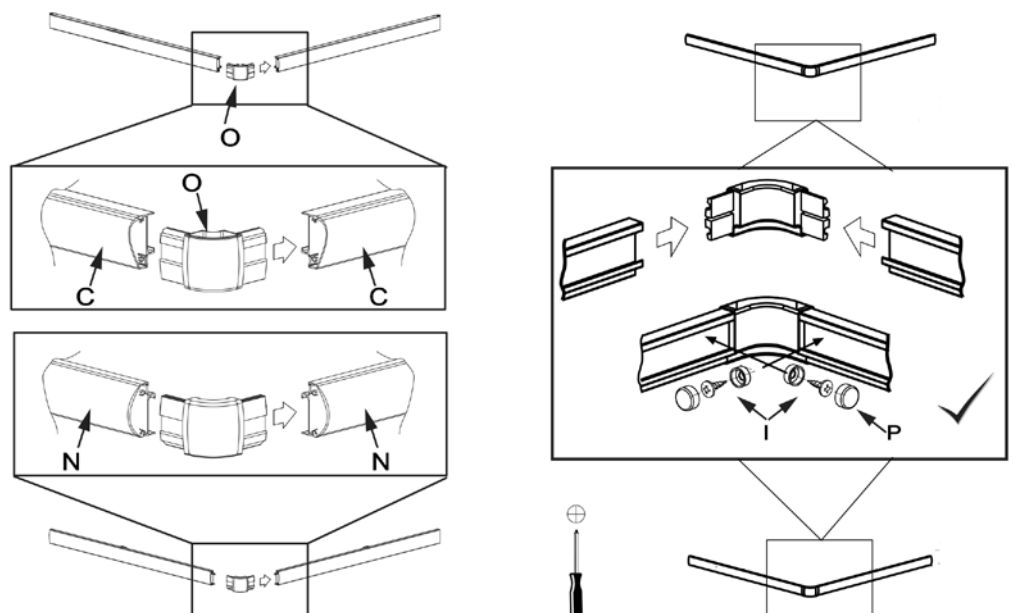

Schritt 4

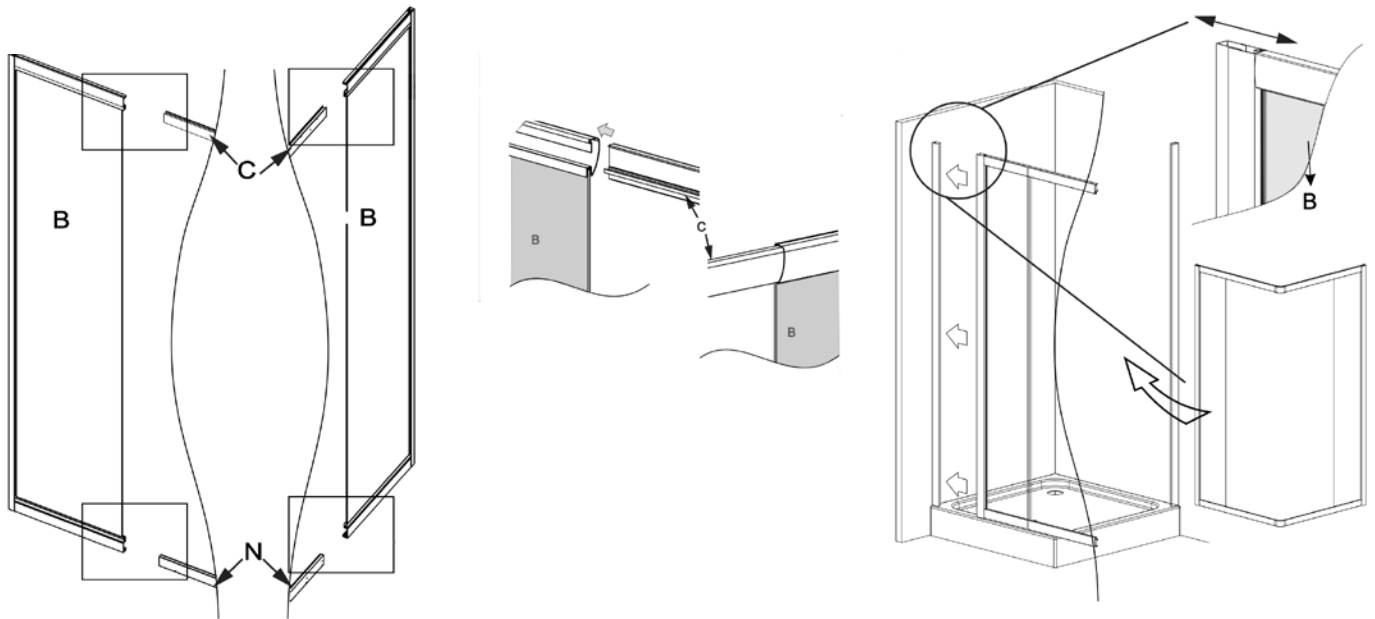

Schritt 5

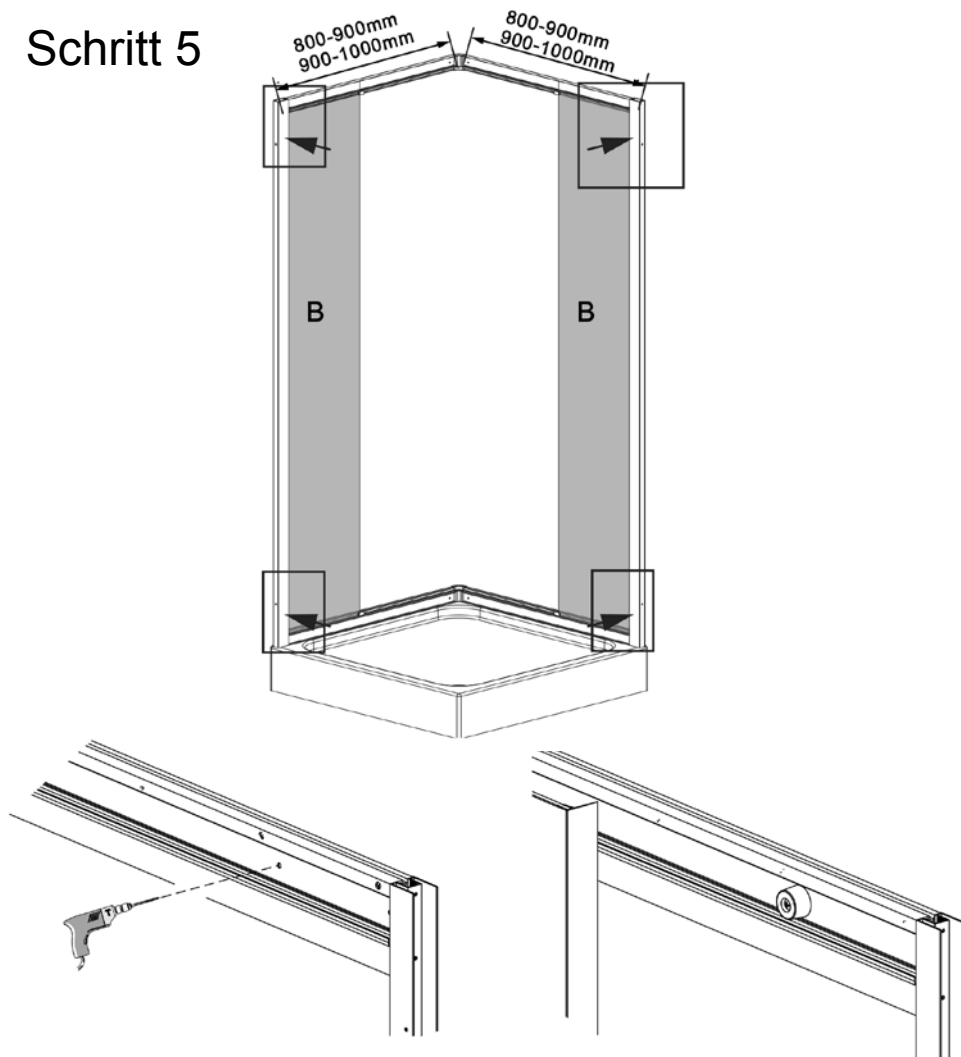

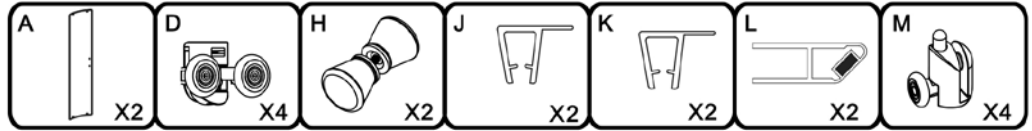

Schritt 6

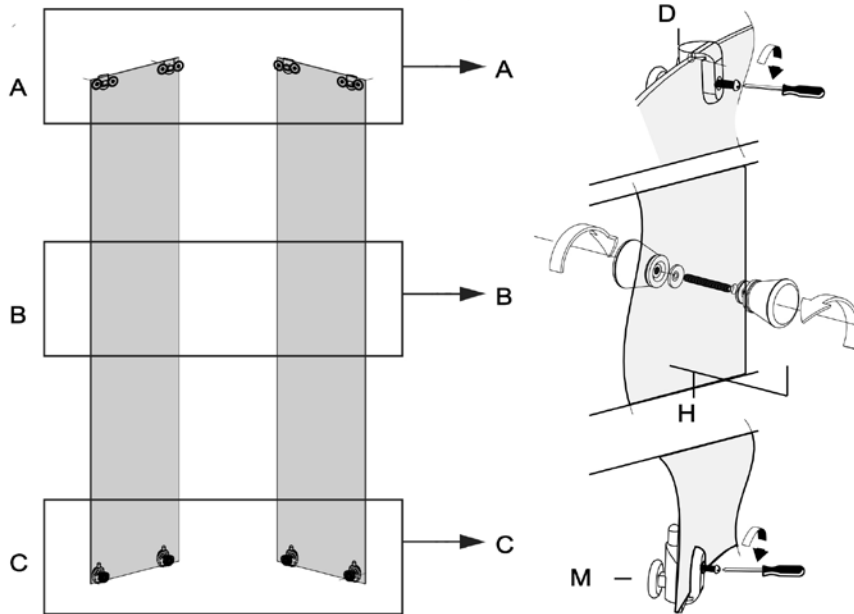

Schritt 7

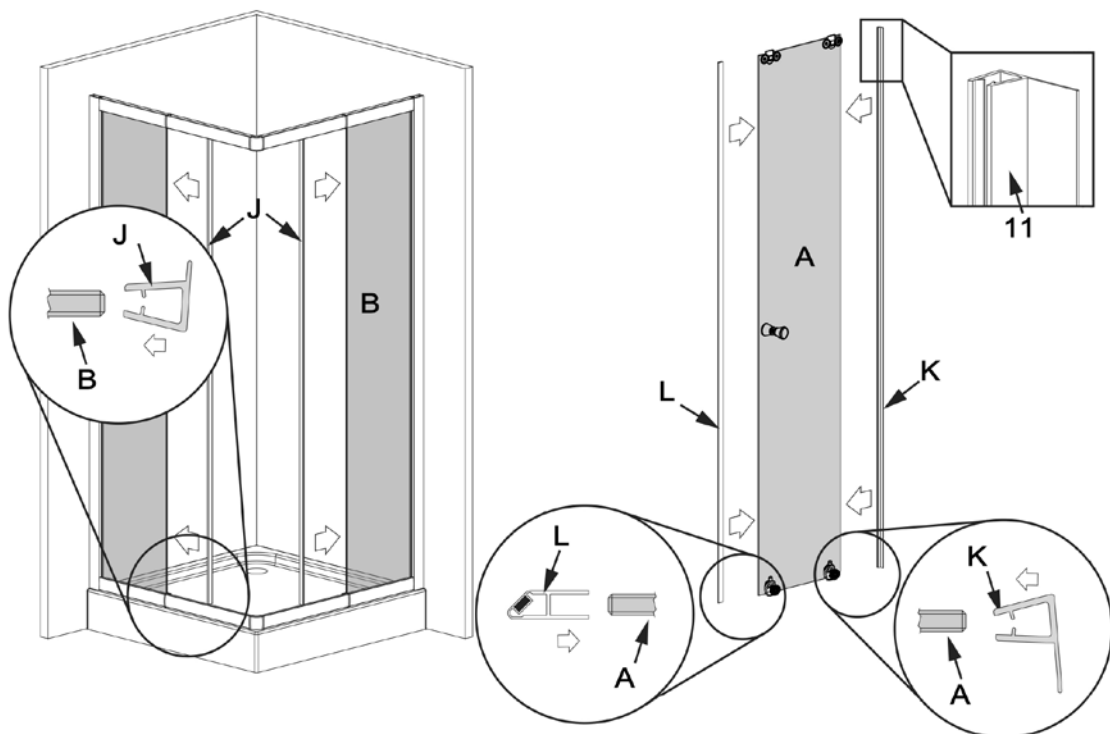

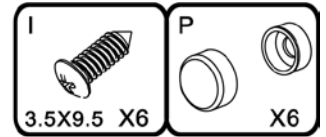
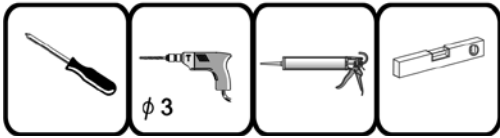

Schritt 8

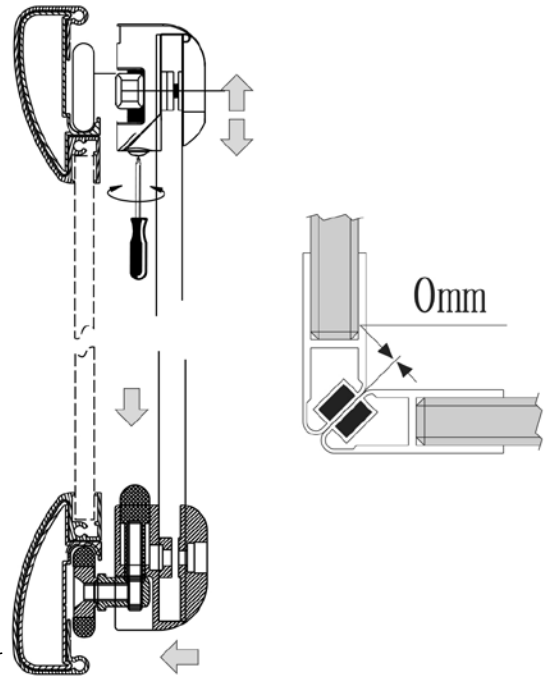
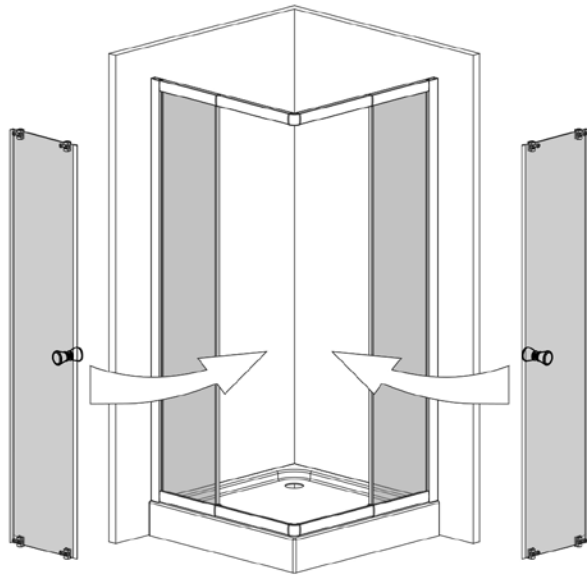

⚠ Stellen Sie sicher, dass die Wandprofil lotrecht sind. Richten Sie die Kabine mit einer Wasserwaage so aus, dass sie rechteckig und gerade ist. Die Rädchen sollten so angebracht sein, dass die Türen plan schließen und leichtgängig zu öffnen und zu schließen sind.

Schritt 9

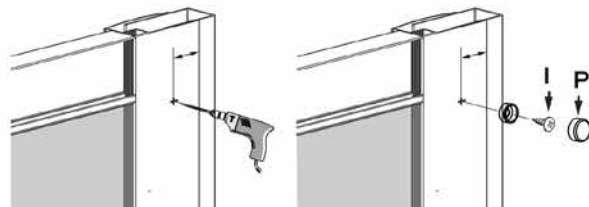
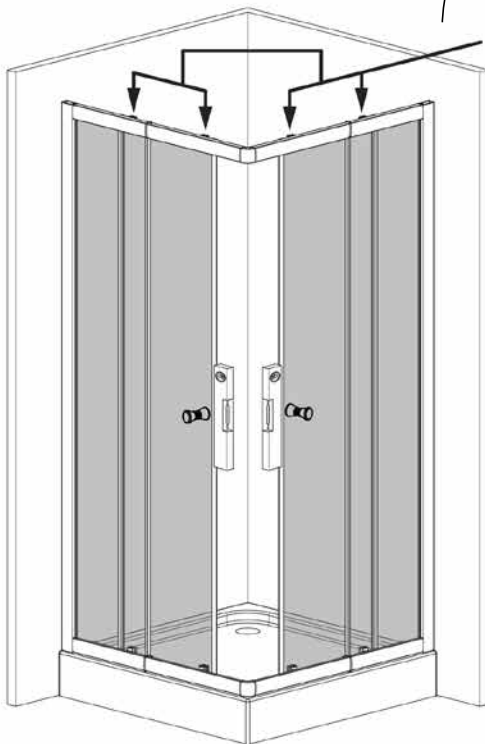

Schritt 10

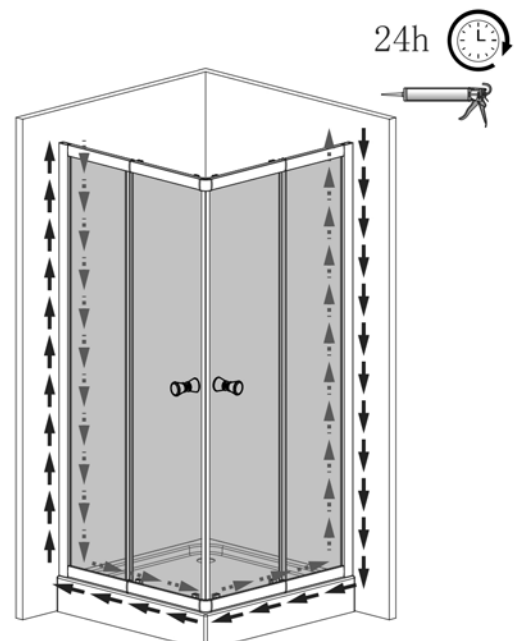

Entsorgung

Sollte dieser Artikel einmal nicht mehr benutzt werden können, so ist jeder Verbraucher gesetzlich verpflichtet, Altgeräte getrennt vom Hausmüll zu entsorgen und z.B. bei einer Sammelstelle seiner Gemeinde / Stadtteils abzugeben.

Unser Service

Eine umgehende Fachberatung erhalten Sie von unserem Service-Team:

- **Deutschland:** Telefon 01806-63 06 30, Festnetz 20ct/Anruf, Mobilfunk max. 60 ct/Anruf
- **Österreich,** Universal: Telefon +43 / 662-4485 59, Festnetz je nach Betreiber, Fachberatung Heimwerken – Otto: +43 / 316-606 159 Festnetz je nach Betreiber, Beratung Heimwerken – Quelle: +43 / 662-9005 59 Festnetz je nach Betreiber, Fachberatung Heimwerken
- **Schweiz,** Quelle: **DE:** +41 / 848 85 85 00, **FR:** +41 / 848 85 85 01, **I:** +41 / 848 858 530
Ackermann: **DE:** +41 / 848 85 85 11, **FR:** +41 / 848 85 85 21, **I:** +41 / 848 858 530
- **Niederlande,** call center 0900-1901 (15ct/Min.)

Um Ihnen schnell helfen zu können, nennen Sie uns bitte:

Artikelbezeichnung: Variabler Eckeinstieg Trento

B8090 – 51194155 / 33331037
B8090WS – 70567511 / 39956613
B8090C – 68165331 / 28384669
B8090CS – 13717463 / 21371865
B8090B – 46713949 / 42547161
B8090BS – 86067306 / 75104752

und die **Artikelnummer** unter der Sie den Artikel bestellt haben (siehe Rechnung).

Informationen zur Leistungserklärung (DoP) gemäß EU-Bauproduktenverordnung finden Sie unter www.aproductZ.com.

Die Leistungserklärung ist mittels der Artikelnummer abrufbar oder auf Anfrage erhalten Sie die Leistungserklärung (DoP) schriftlich zugeschickt.

Imported by AproductZ GmbH Werner-Otto-Str. 1 – 7 22179 Hamburg Germany

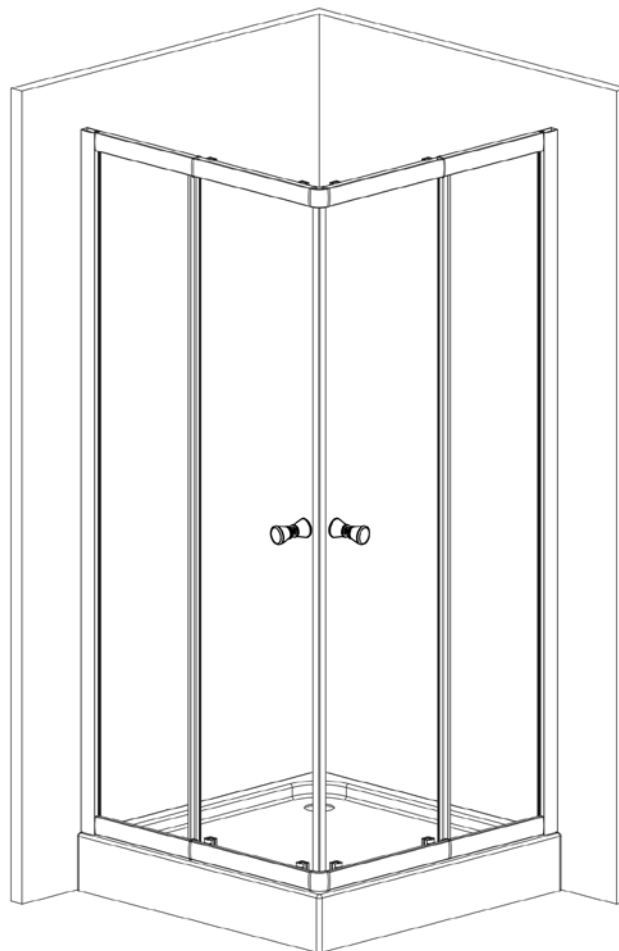

Variable Entry Shower Trento

Size: 900 x 900 x 1800 mm

B8090 – 51194155 / 33331037
 B8090WS – 70567511 / 39956613
 B8090C – 68165331 / 28384669
 B8090CS – 13717463 / 21371865
 B8090B – 46713949 / 42547161
 B8090BS – 86067306 / 75104752



**Aufbauanleitung
 Duschekeinstieg**



**Istruzioni d'installazione
 Entrata ad angolo per doccia**



**Installation Instruction
 Square Shower**



**Montagehandleiding
 Hoekinstap douche**



**Instructions d'installation
 Cabine de douche accès d'angle**

D: Nachdruck, auch auszugsweise, nicht gestattet! **GB:** Reproduction, even in extracts, is not permitted! **F:** Toute reproduction de ce mode d'emploi même par extraits est interdite ! **IT:** È vietata la riproduzione, anche parziale. **NL:** Nadruk, ook slechts gedeeltelijk, niet toegestaan!

Instruction No. 20160356

IMPORTANT: PLEASE KEEP THIS DOCUMENT FOR LATER REFERENCE!
READ CAREFULLY!

Indented use

- This product is a prefabricated unit for showering.
- This product is intended for use in private spheres only.



Safety instructions

- Choking hazard / danger of injury! Do not let children play with the packaging. They might suffocate by the wrapping or injure themselves with the packaging cover.
- Make sure that children do not take small parts such as nuts, cover caps or the like into their mouths. They could swallow these and choke on them.
- Risk of damage! Please read the assembly instructions very carefully prior to assembling and check the product for possible transportation damage. Be careful during the product's assembly.
- The product must only be installed by competent persons. The assembly is recommended to be conducted by two people.
- Danger of injury! During the assembly, please consider that some parts have sharp edges.
- Fix product to suitable and solid walls only.
- **Caution:** The wall fixtur of the piece of furniture must be carried out by a competent person because it requires customized plugs.
- Make sure that there are no wires or pipelines in the drilling ranges.
- Check the areas with a metal detector prior to drilling.
- Handle the glass components with care! Hold the glass components firml during installation to not let them drop.
- Seal the shower partition with silicone from the outside. Do not use shower before lapse of 24 hours after sealing.
- To connect the tub with the own in-house water disposal, a commercial siphon with a flexibl sewage hose should be used.
- To order spare parts (see part's list), please contact the customer service.

Maintenance instructions

Clean the glass surfaces with a wet cloth and some glass cleaner and wipe with a dry cloth. Environmentally friendly and gentle cleaning agents suffice. By no means use any aggressive liquids or cleaning agents containing solvents. Never use sharp objects, steel wool, chemicals or sandy scouring agents for cleaning. These lead to surface damage and loss of warranty. Slight lime deposits are easily removed with some household vinegar.

Tools required

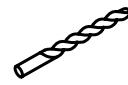
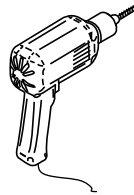
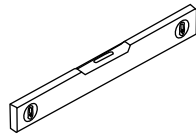
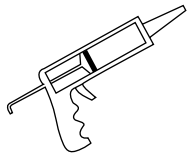

Ø 6mm

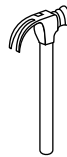
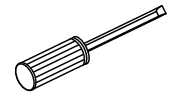

Ø 3.2mm

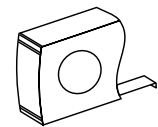
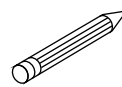
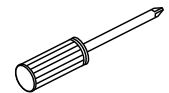

**This product is heavy and may require
two people to install.**

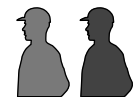

Box contents

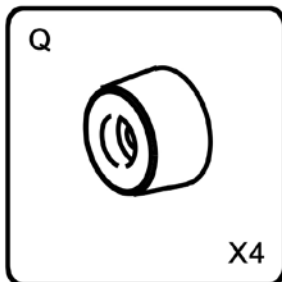
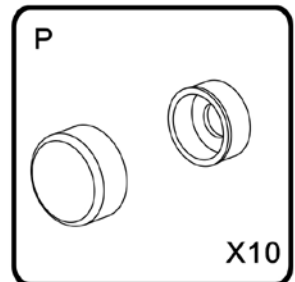
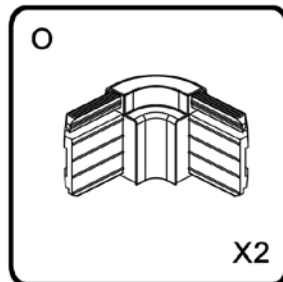
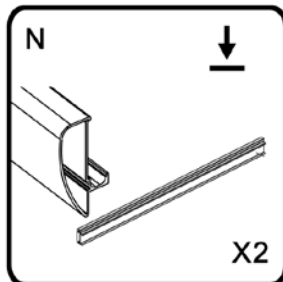
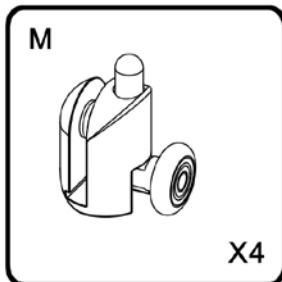
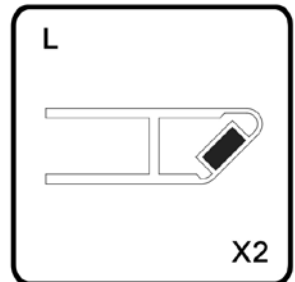
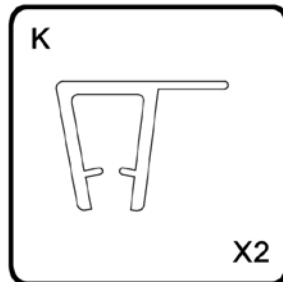
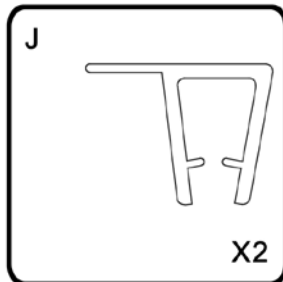
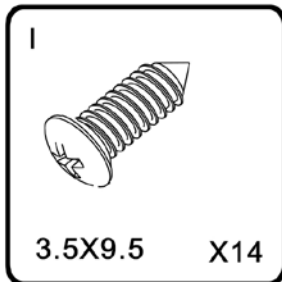
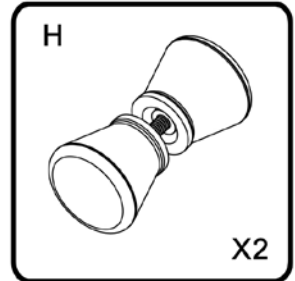
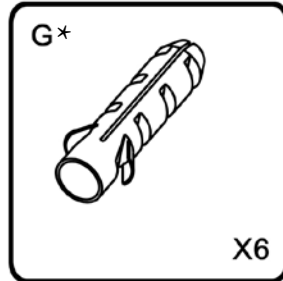
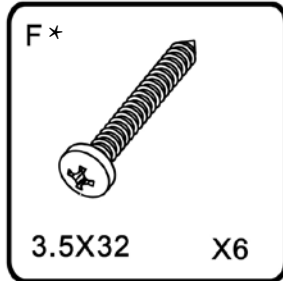
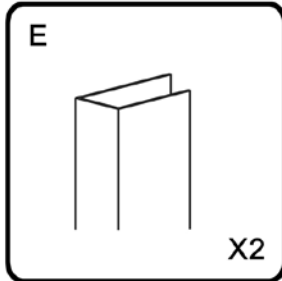
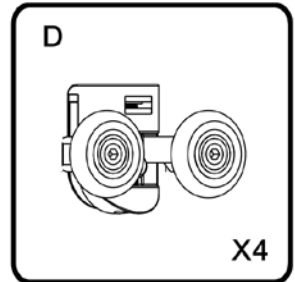
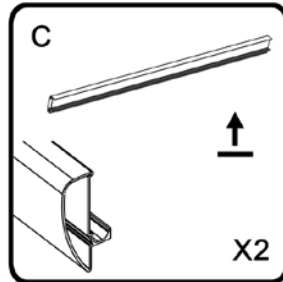
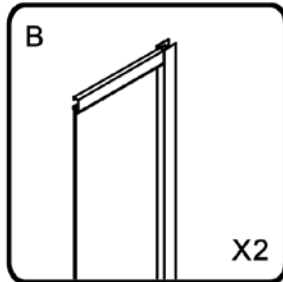
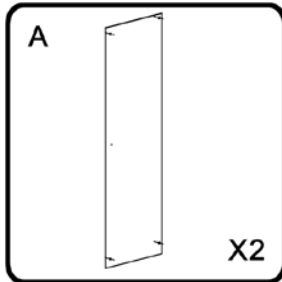
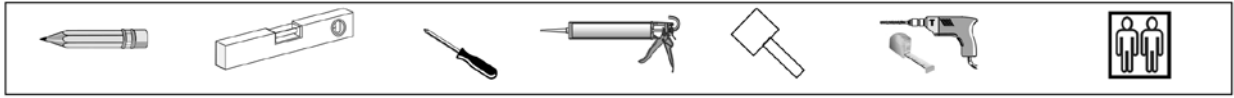

*not included

Assembly drawing

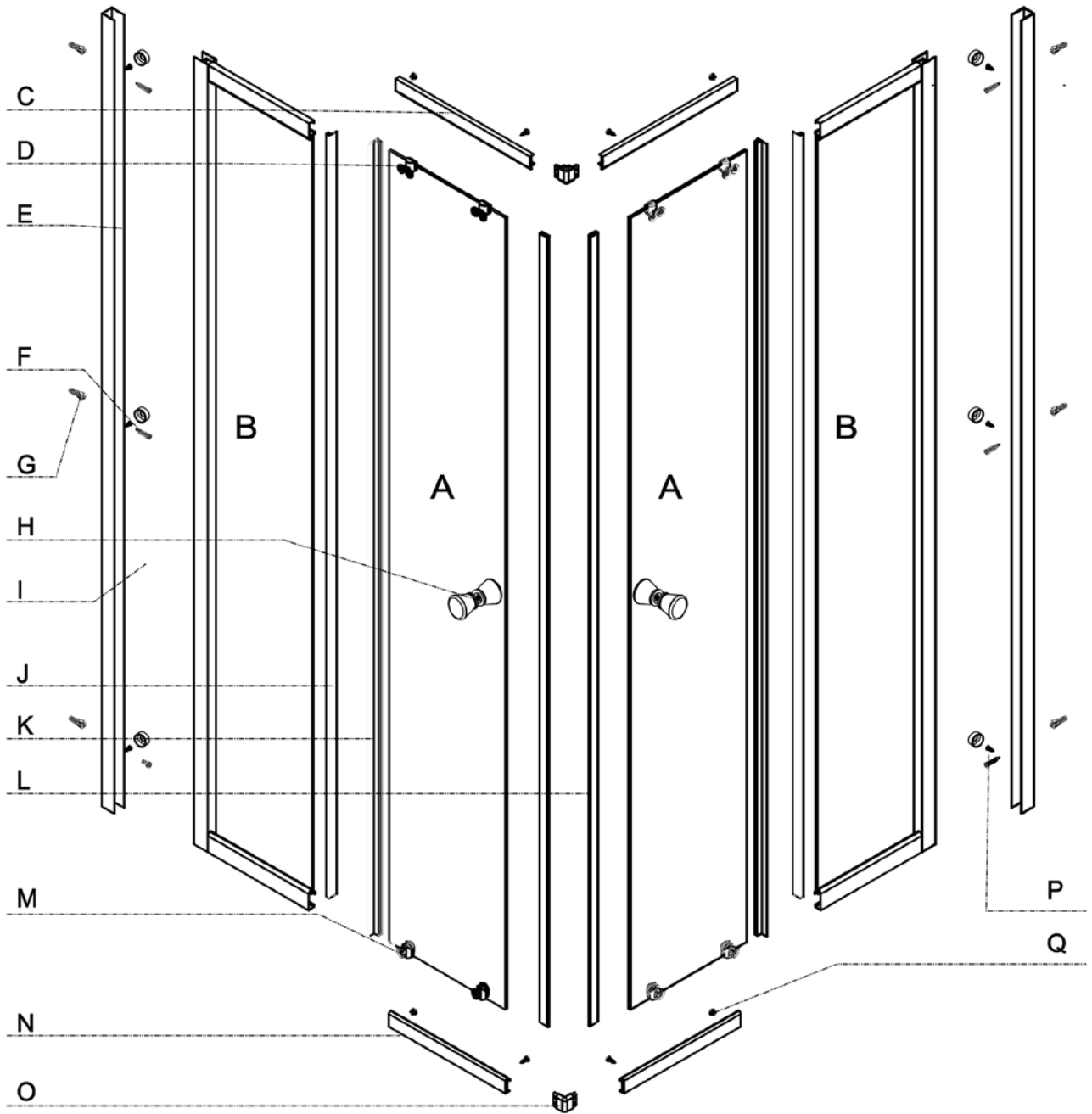

Installation steps



*not included

Step 1

- The tub is to be aligned with vertical walls in a 90 degree angle by means of a spirit level.
- The joints are to be filled with silicone. Select type of silicone in accordance with construction material used. Please mind curing times.

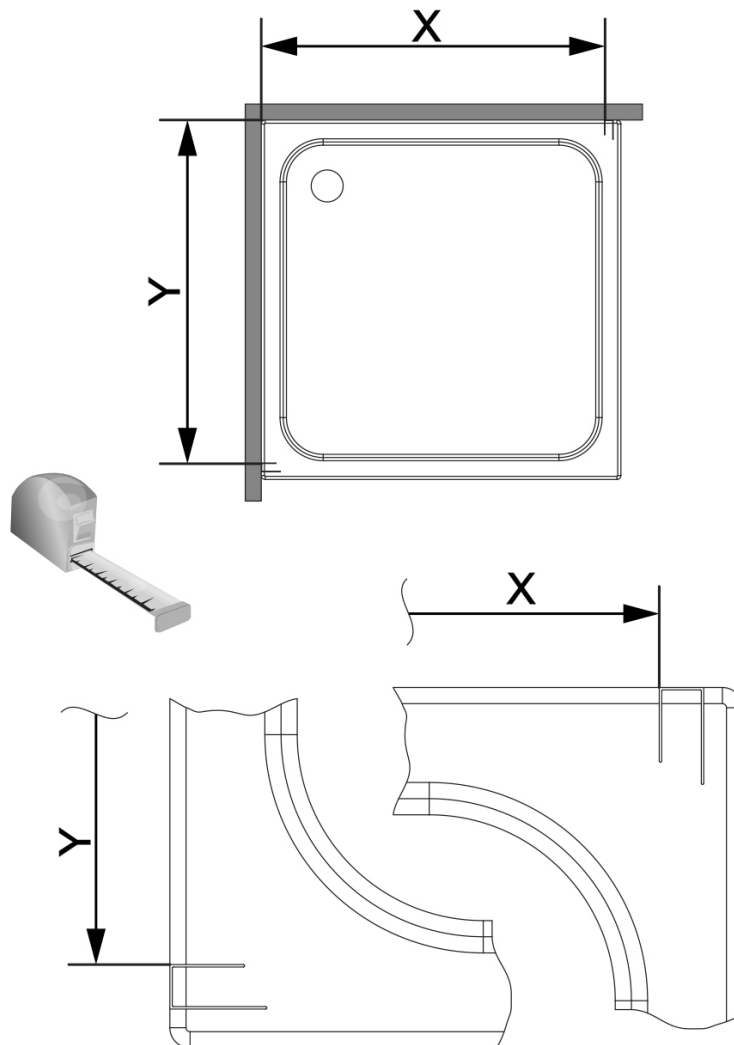

Step 2

Align the frame body with a spirit level. Draw the mounting holes. Mount the frame body to the wall as shown in pictograms.

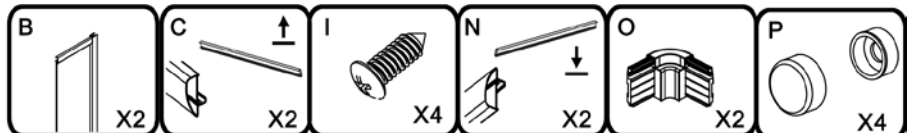
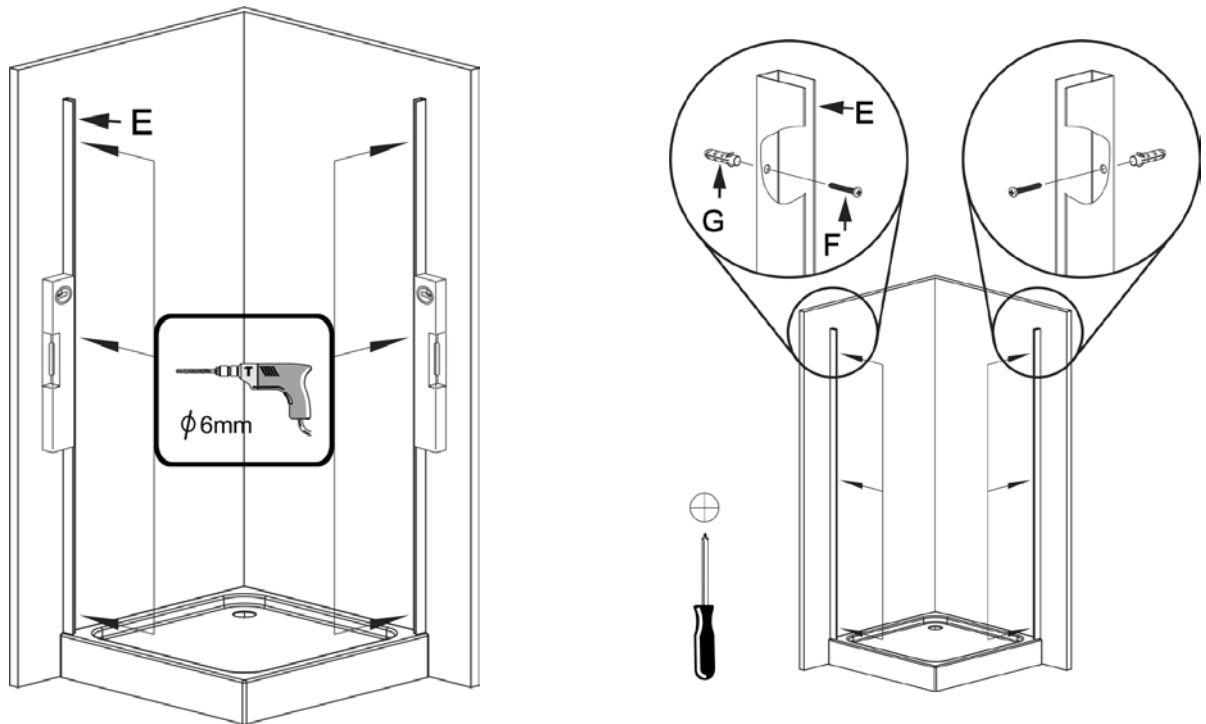

Step 3

Put the corner connections together accordingly, and screw them up tight on top and bottom.

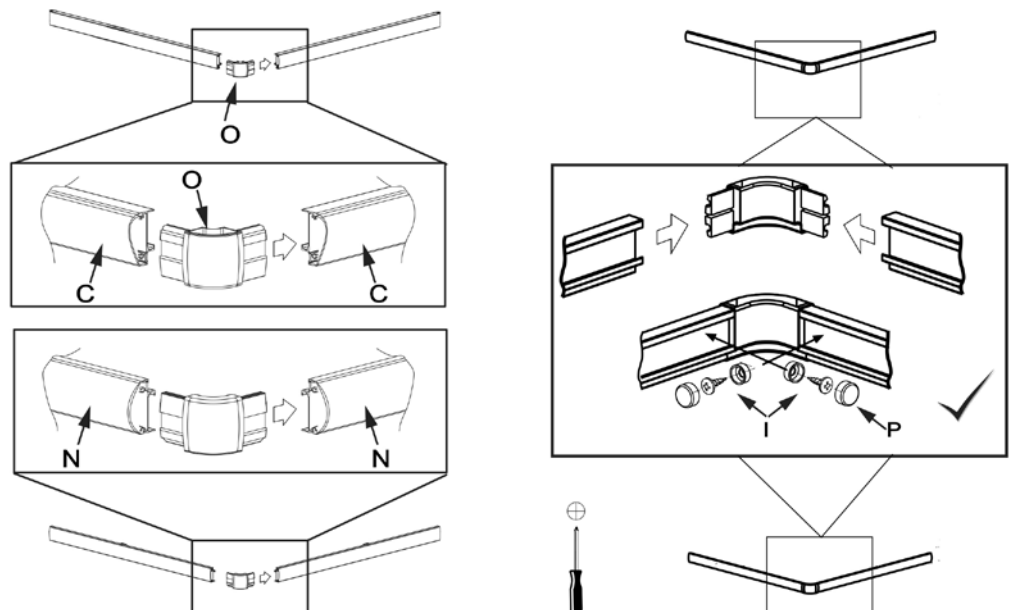

Step 4

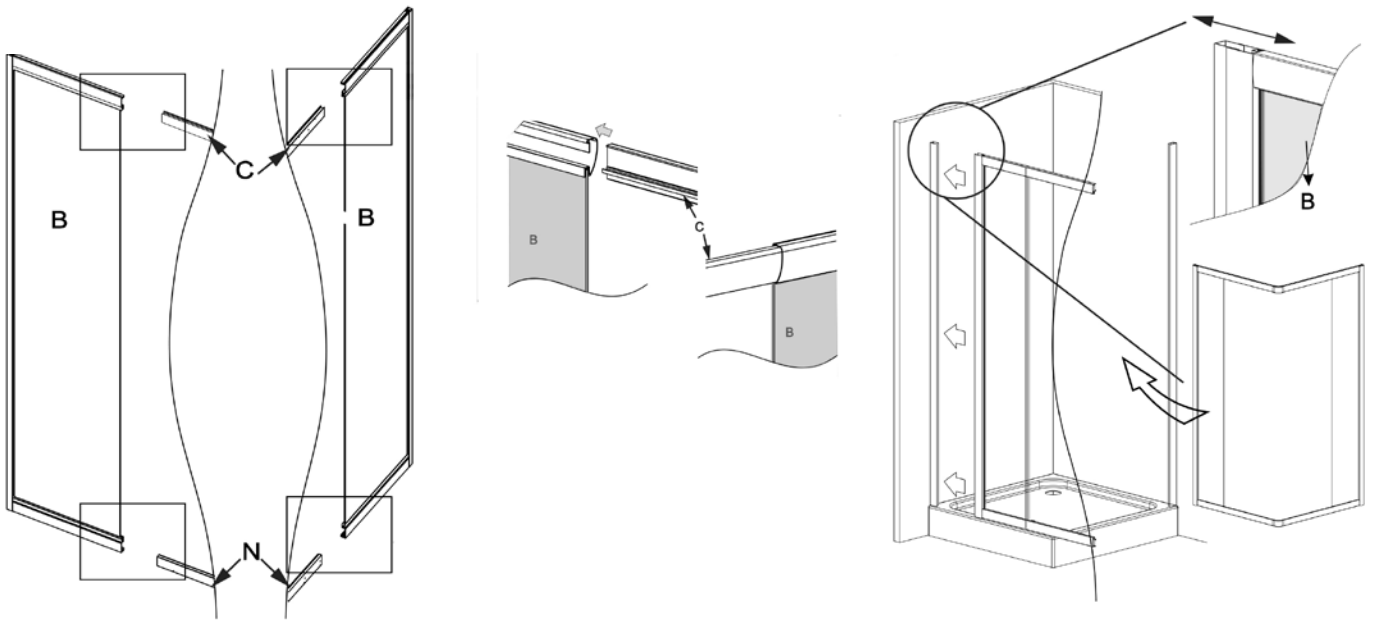

Step 5

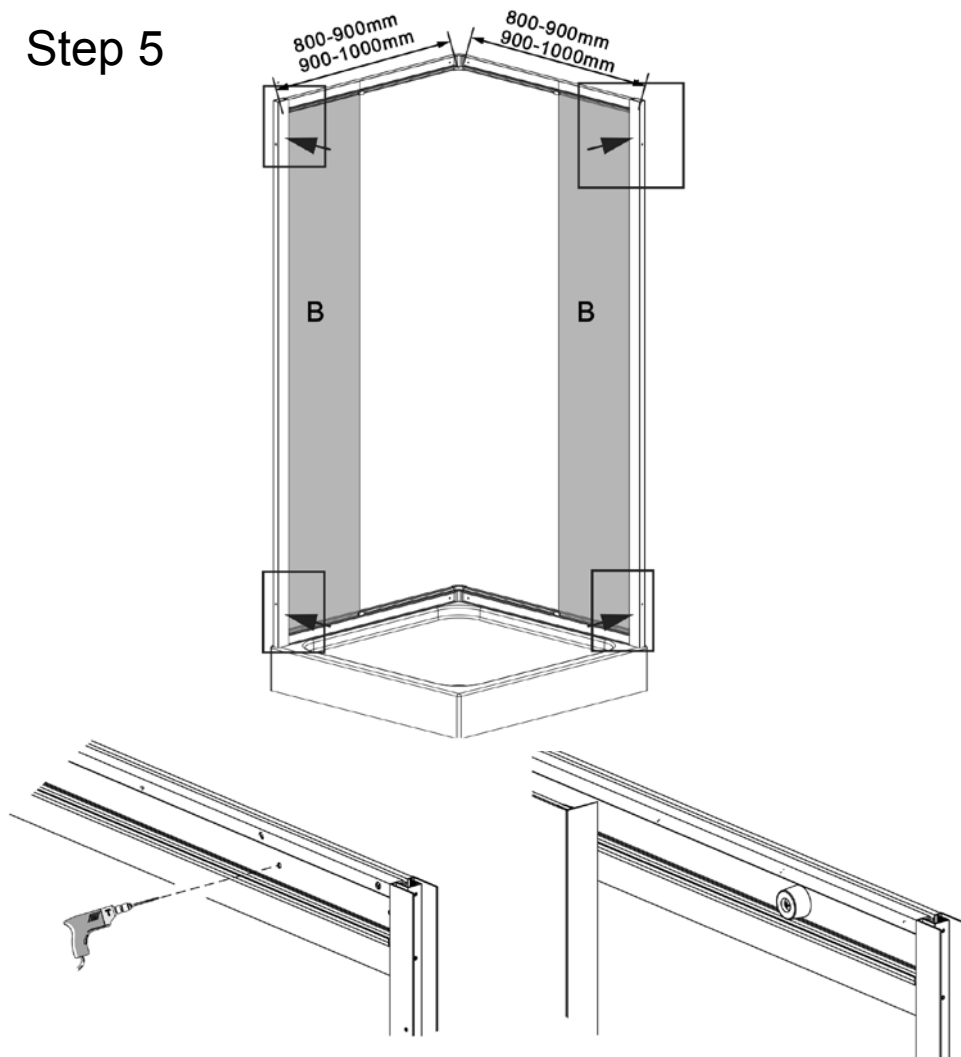

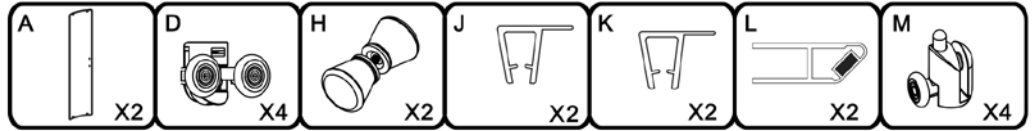

Step 6

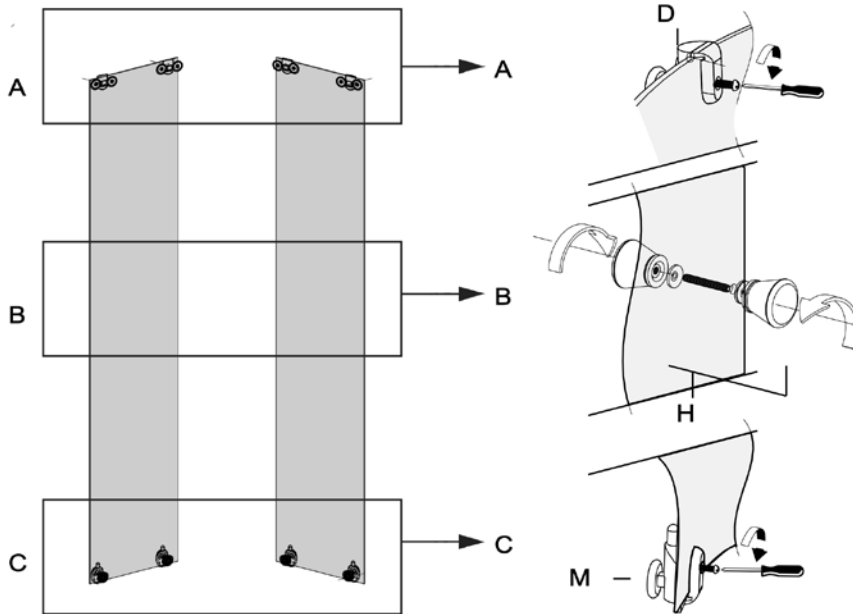

Step 7

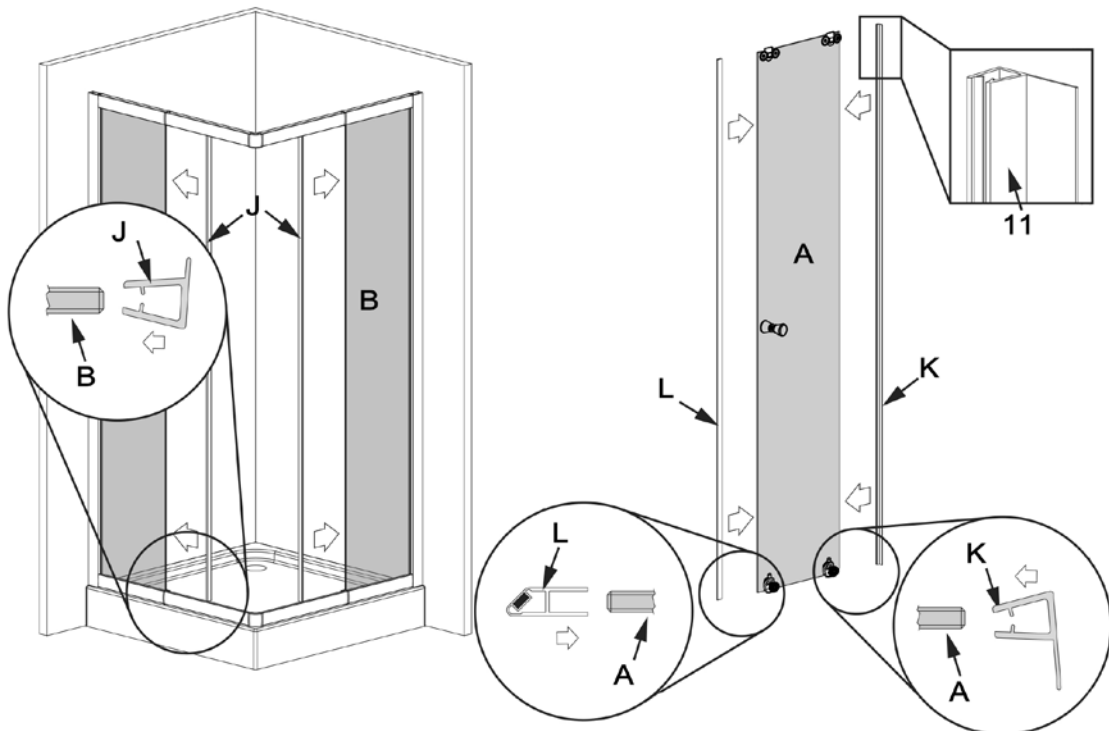

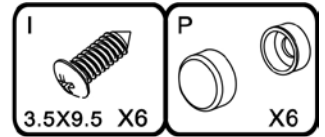
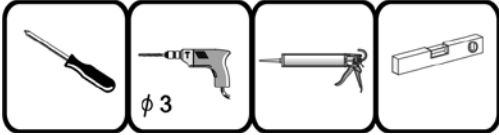

Step 8

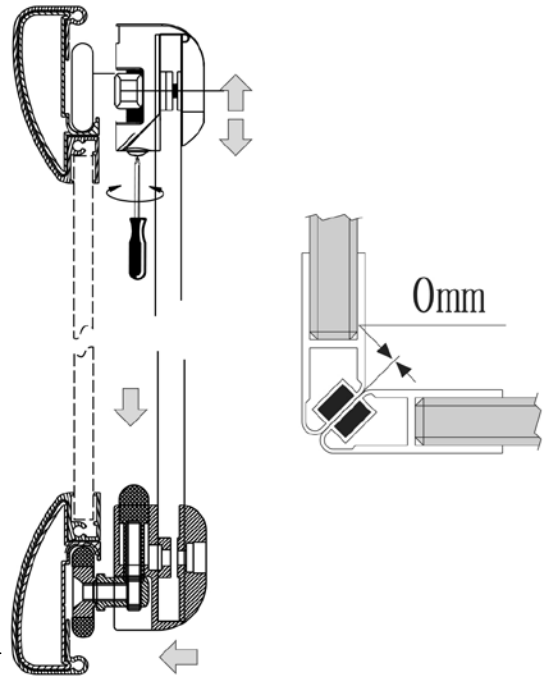
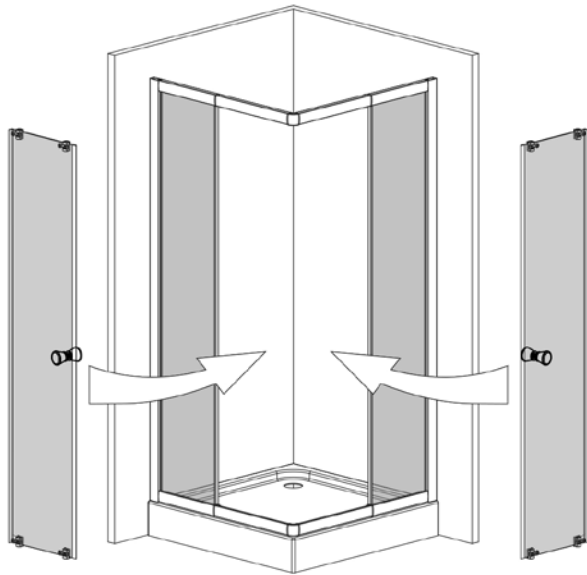

0mm

⚠ Ensure wall profile are plumb. Use spirit level to adjust stall to be square and level. The small rolls are to be fixed in a way to make doors close evenly, and to enable doors to open and close smoothly.

Step 9

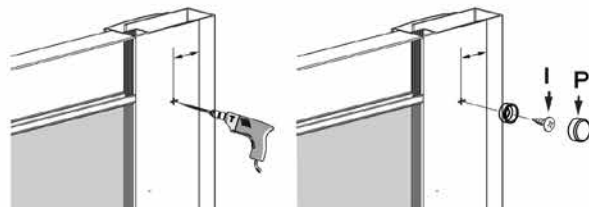
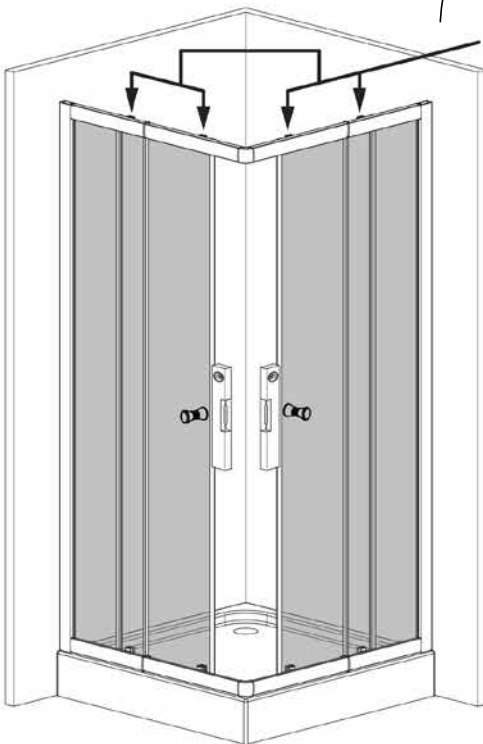

I P

Step 10

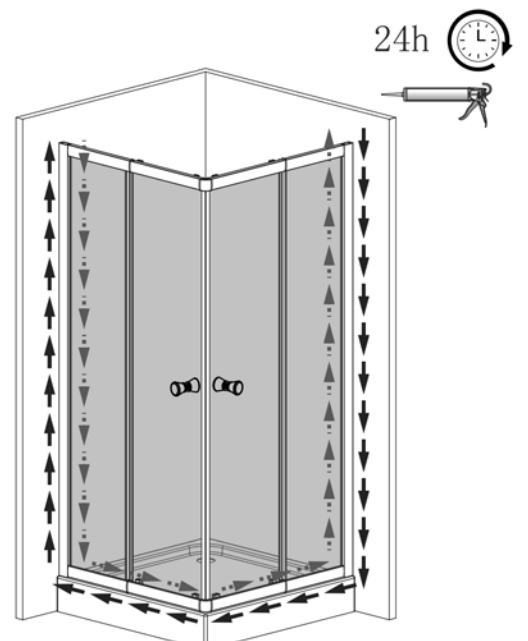

24h

Disposal

Should the product no longer be serviceable, every consumer has a statutory obligation to dispose of old appliances separately from domestic waste and dispose of them e.g. at a local authority / district collection point.

Our service

You will receive prompt professional advice from our service team:

- **Germany:** Telephone 01806-63 06 30, Land line 20ct/call, mobile telephone connection 60ct/call max.
- **Austria, Universal:** Telephone +43 / 662-4485 59 landline depending on provider, Home improvement expert service - Otto: +43 / 316-606 159 landline depending on provider, Home improvement expert service - Quelle: +43 / 662-9005 59 landline depending on provider, Home improvement expert service
- **Switzerland, Quelle:** **DE:** +41 / 848 85 85 00, **FR:** +41 / 848 85 85 01, **I:** +41 / 848 858 530
Ackermann: **DE:** +41 / 848 85 85 11, **FR:** +41 / 848 85 85 21, **I:** +41 / 848 858 530
- **The Netherlands:** call center 0900-1901 (15ct/min.)

In order to assist you more efficiently, please tell us the:

Product designation: Variable Entry Shower Trento

B8090 – 51194155 / 33331037
B8090WS – 70567511 / 39956613
B8090C – 68165331 / 28384669
B8090CS – 13717463 / 21371865
B8090B – 46713949 / 42547161
B8090BS – 86067306 / 75104752

and **item number** you used to order the item (see invoice).

You can find information on the Declaration of Performance (DoP) pursuant to the EU Construction Products Regulation at www.aproductZ.com.

You can access the Declaration of Performance (DoP) with the help of the product number or you can have the document sent to you on request.

Imported by AproductZ GmbH Werner-Otto-Str. 1 – 7 22179 Hamburg Germany

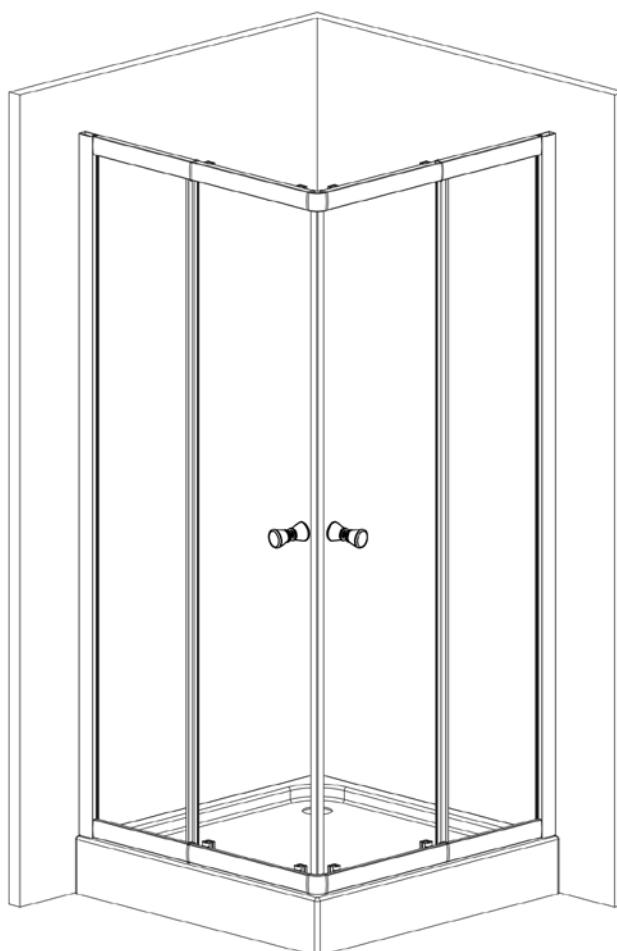

Accès d'angle variable Trento

Dimensions : 900 x 900 x 1800 mm

B8090 – 51194155 / 33331037
 B8090WS – 70567511 / 39956613
 B8090C – 68165331 / 28384669
 B8090CS – 13717463 / 21371865
 B8090B – 46713949 / 42547161
 B8090BS – 86067306 / 75104752



**Aufbauanleitung
 Duschekeinstieg**



**Istruzioni d'installazione
 Entrata ad angolo per doccia**



**Installation Instruction
 Square Shower**



**Montagehandleiding
 Hoekinstap douche**



**Instructions d'installation
 Cabine de douche accès d'angle**

D: Nachdruck, auch auszugsweise, nicht gestattet! **GB:** Reproduction, even in extracts, is not permitted! **F:** Toute reproduction de ce mode d'emploi même par extraits est interdite ! **IT:** È vietata la riproduzione, anche parziale. **NL:** Nadruk, ook slechts gedeeltelijk, niet toegestaan!

Instruction No. 20160356



**IMPORTANT, CONSERVER CE DOCUMENT POUR TOUTE RÉFÉRENCE
ULTÉRIEURE ! À LIRE ATTENTIVEMENT !**

Utilisation conforme à la destination

- Cet article est un ensemble de douche préfabriqué.
- Cet article n'est destiné qu'à un usage de type privé.



Avis de sécurité

- Risque d'étouffement / de blessure ! Ne laissez pas les enfants jouer avec l'emballage car ils pourraient s'étouffer avec le fil ou se blesser avec les matériaux d'emballage.
- Veillez à ce que les enfants ne portent pas à la bouche de petits éléments comme les écrous, rondelles de couverture ou autres. Ils pourraient les avaler et s'étouffer avec.
- Risque de dégradations ! Avant le montage, merci de lire très attentivement les instructions de montage et de vérifier que le produit n'a pas été endommagé au cours du transport. Merci de procéder au montage de l'article avec de grandes précautions.
- L'article ne peut être assemblé que par du personnel compétent. Il est conseillé de procéder au montage à deux personnes.
- Risque de blessure ! Lors du montage, prenez en compte le fait que le produit présente plusieurs arêtes vives.
- Ne montez l'article que contre des murs massifs et adaptés.
- **Attention** : La fixation des éléments de mobilier au mur doit être effectuée par du personnel compétent, car des chevilles adaptées au mur sont nécessaires pour le montage.
- Assurez-vous qu'aucun câble ou tuyau ne se trouve dans les zones de perçage.
- Avant le perçage, inspectez les zones avec un détecteur de métaux.
- Manipulez les surfaces en verre avec précaution ! Pendant l'assemblage, maintenez fermement les surfaces en verre pour éviter tout risque de chute.
- Isolez le pare-douche depuis l'extérieur avec de la silicone. N'utilisez la douche que 24 heures après l'application de la silicone.
- Pour le raccordement du receveur de douche au système d'évacuation des eaux domestiques, un siphon classique doté d'un tuyau d'évacuation d'eau flexible doit être utilisé.
- Merci de contacter le service clientèle pour toute commande de pièces détachées (voir la liste des pièces).

Instructions d'entretien

Nettoyez les surfaces vitrées avec un chiffon humide et un peu de nettoyant à vitres, puis essuyez-les avec un chiffon sec. N'utilisez jamais de produits de nettoyage agressifs ou contenant des solvants. Pour le nettoyage, n'utilisez jamais d'objets pointus, de laine métallique, de produits chimiques ou de produits à récurer contenant du sable. Ils entraîneront une dégradation de la surface et une privation de la garantie. Les dépôts légers de calcaire peuvent être éliminés sans efforts avec un peu de vinaigre de cuisine.

Outils nécessaires

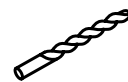
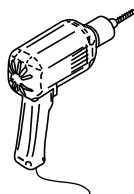
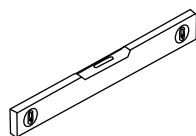
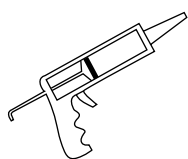

Ø 6mm

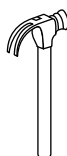
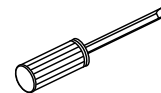

Ø 3.2mm

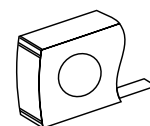
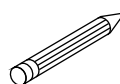
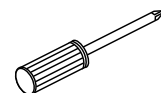

**En raison du poids important de ce produit,
le montage peut nécessiter deux personnes.**

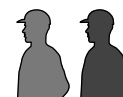

Contenu de l'emballage

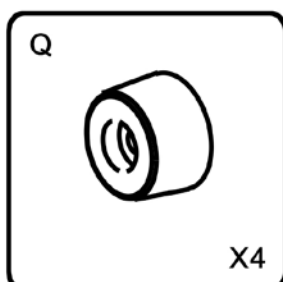
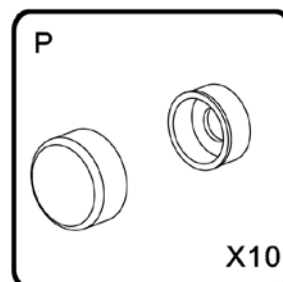
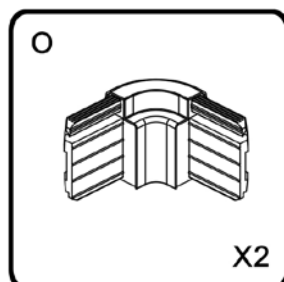
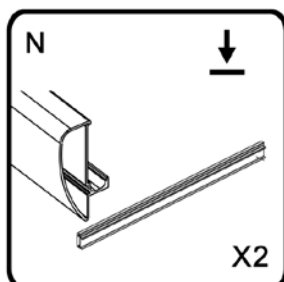
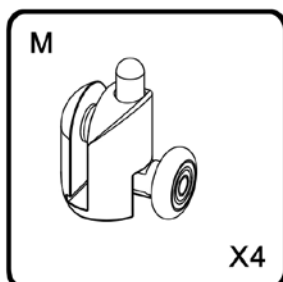
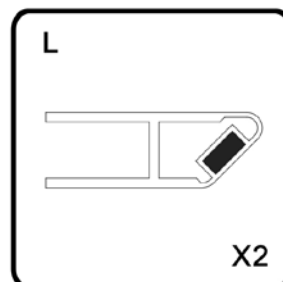
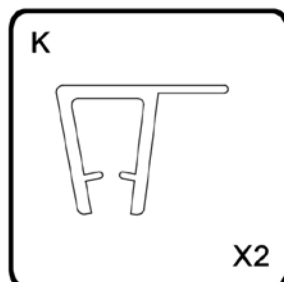
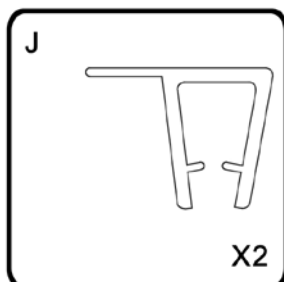
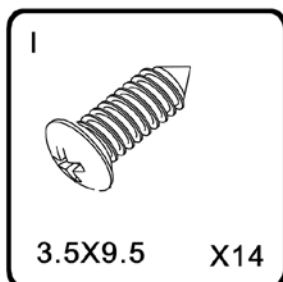
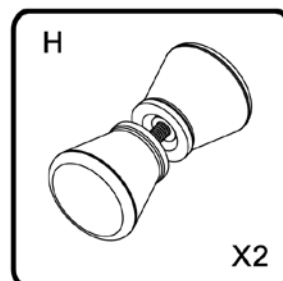
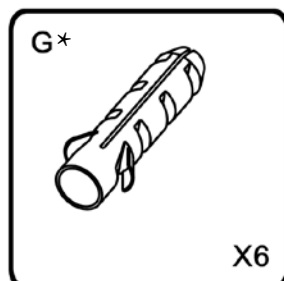
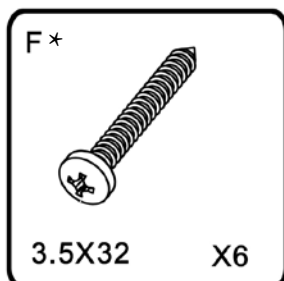
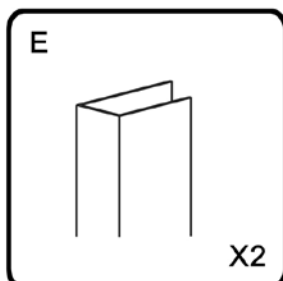
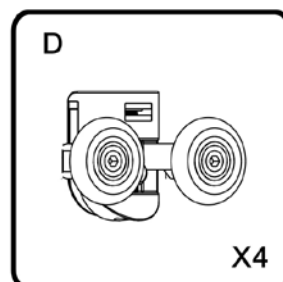
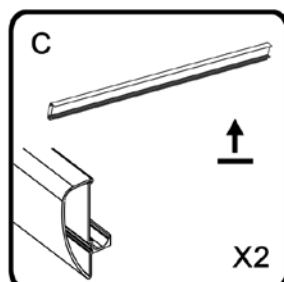
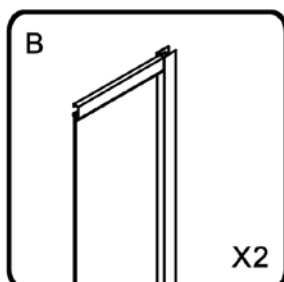
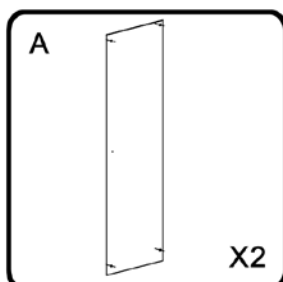
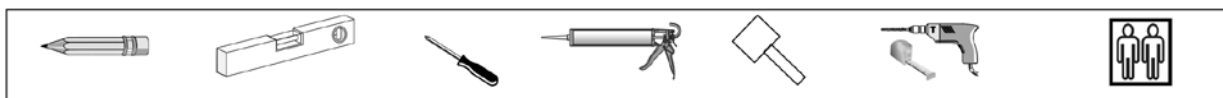

* non compris

Dessin de montage

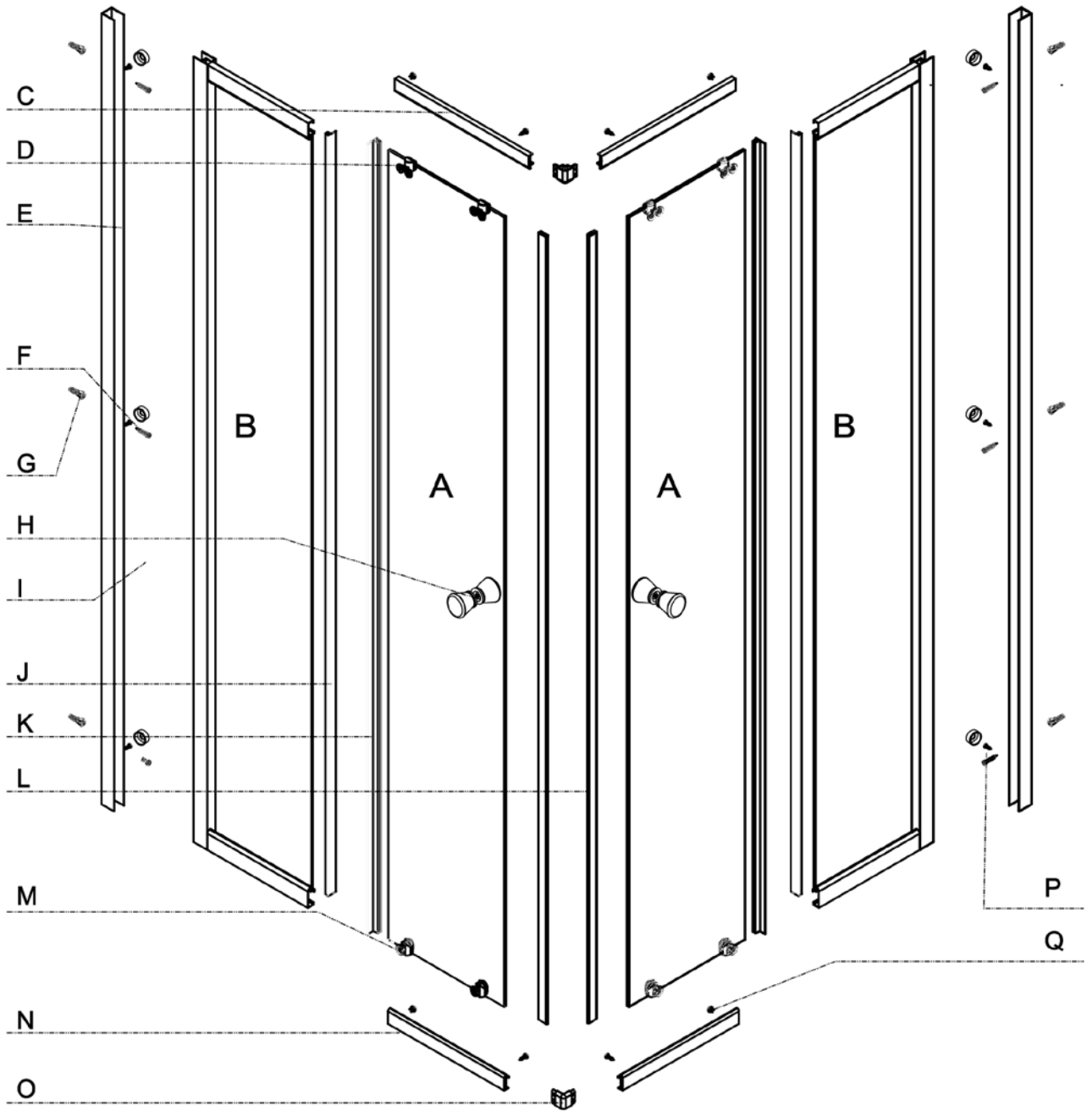

Étapes de construction



*non compris

Étape 1

- Le receveur doit être placé à un angle de 90 ° avec les murs verticaux à l'aide d'un niveau à bulle.
- Les joints doivent être traités à la silicone. La silicone doit être choisie en fonction des matériaux de construction utilisés et le temps de durcissement doit être respecté.

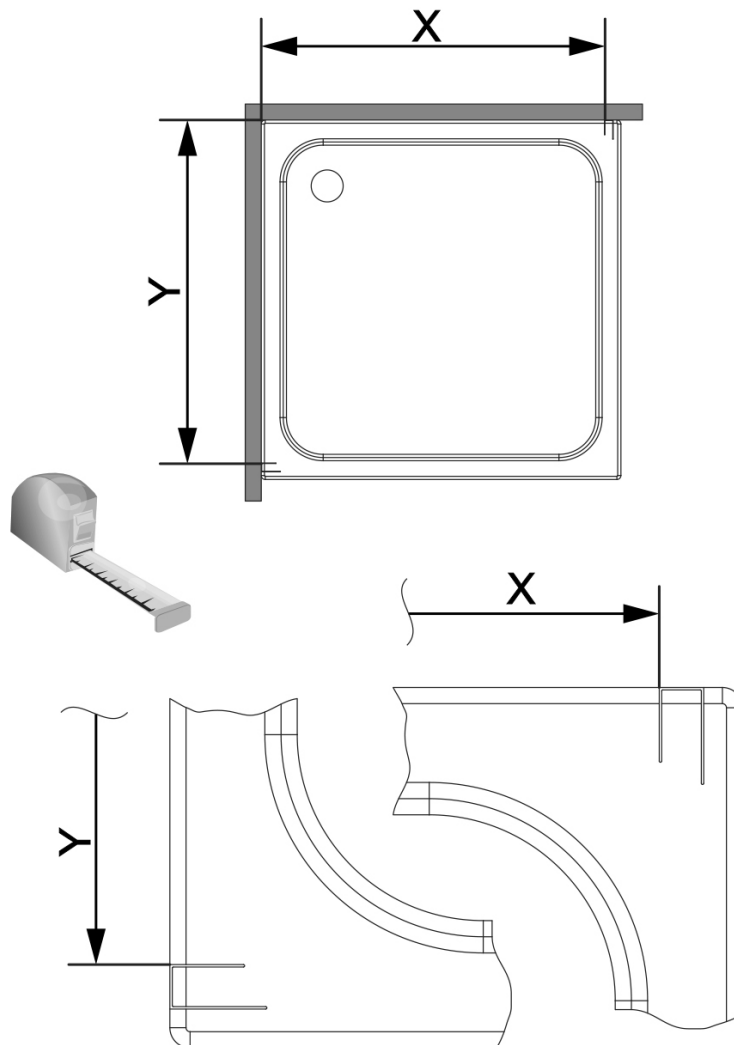

Étape 2

Ajustez maintenant le cadre assemblé sur la douche à l'aide d'un niveau à bulle. Marquez l'emplacement des trous de fixation. Montez le cadre sur le mur comme cela est montré sur les pictogrammes.

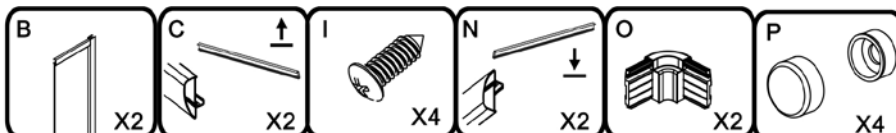
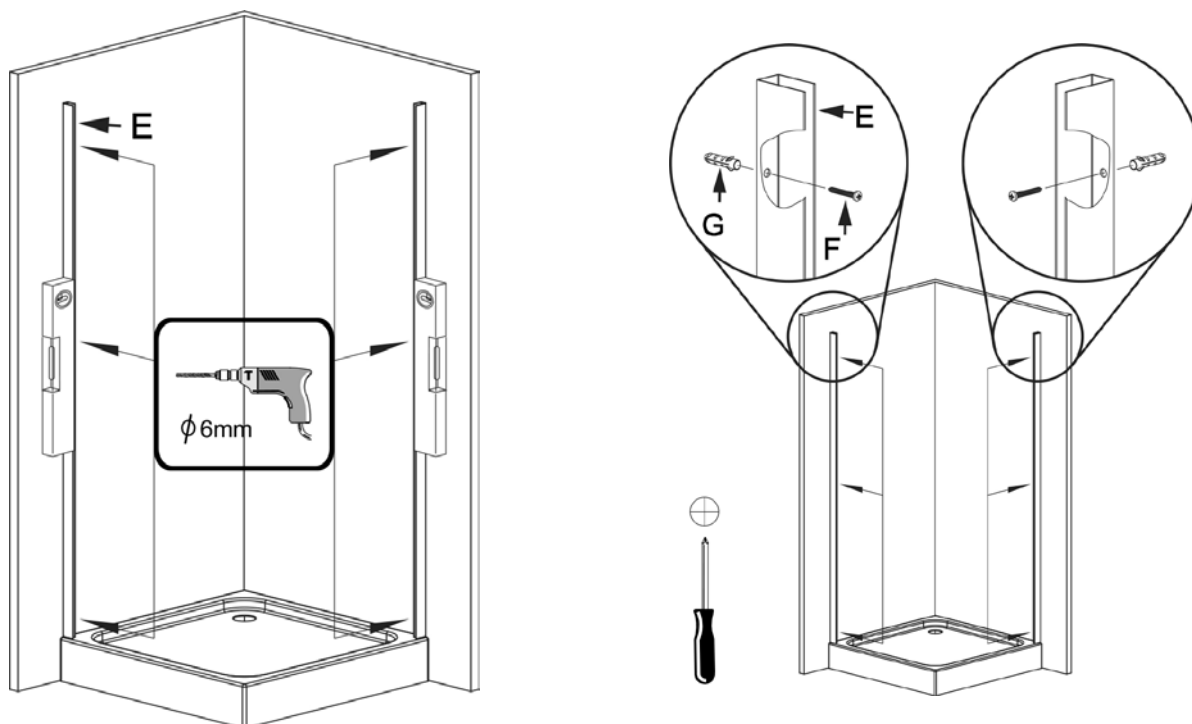

Étape 3

Assemblez les liaisons d'angle en les enfichant en conséquence et vissez-les pour le haut et le bas.

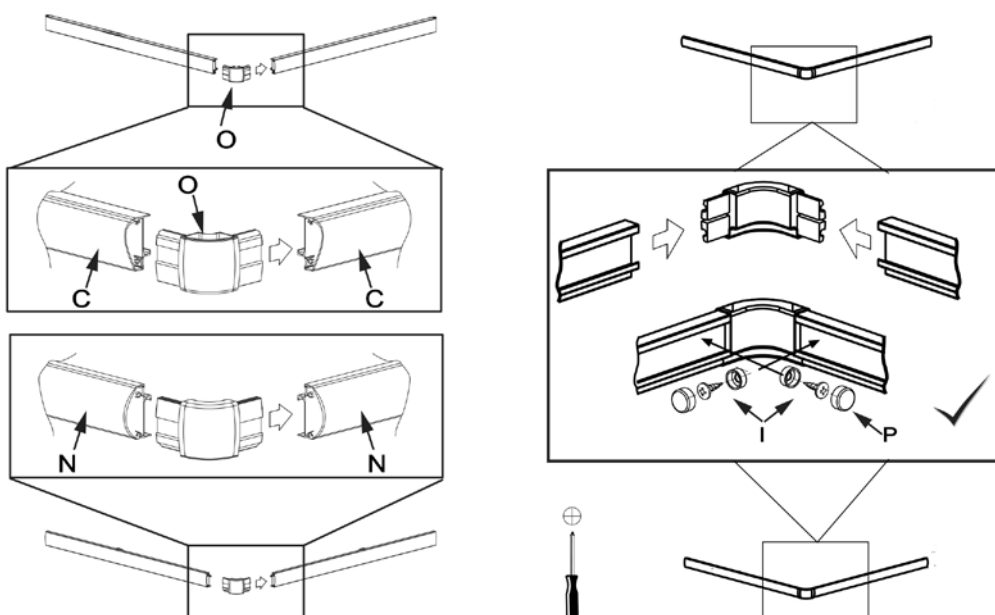

Étape 4

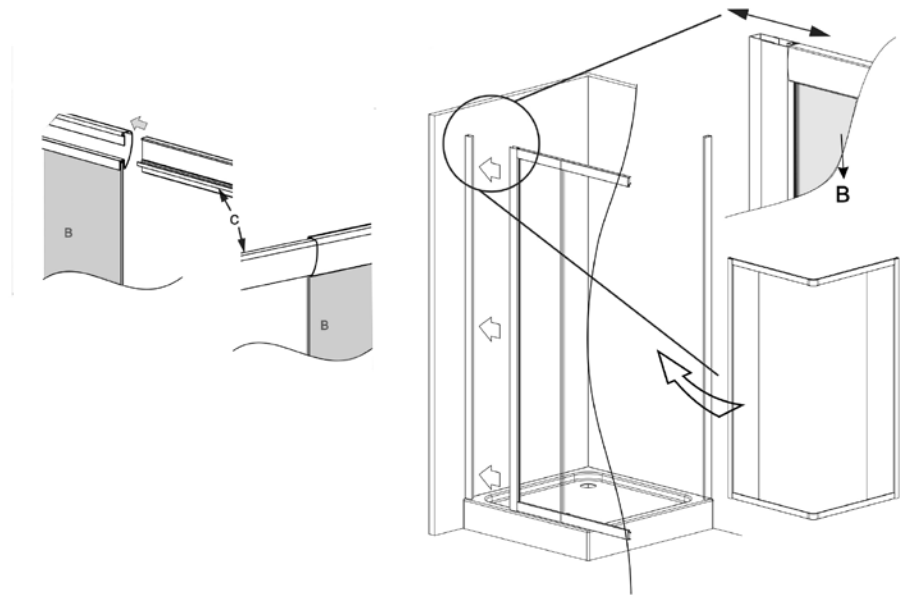
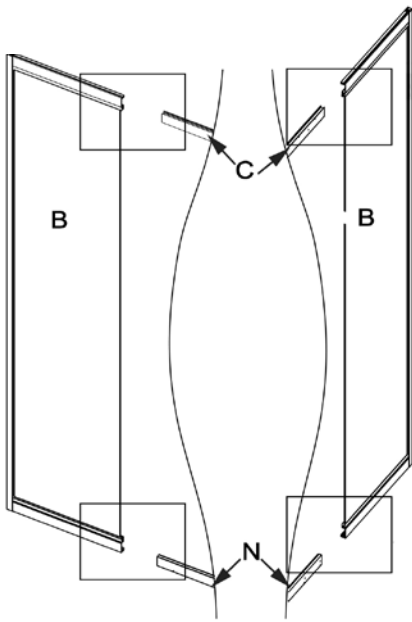

Étape 5

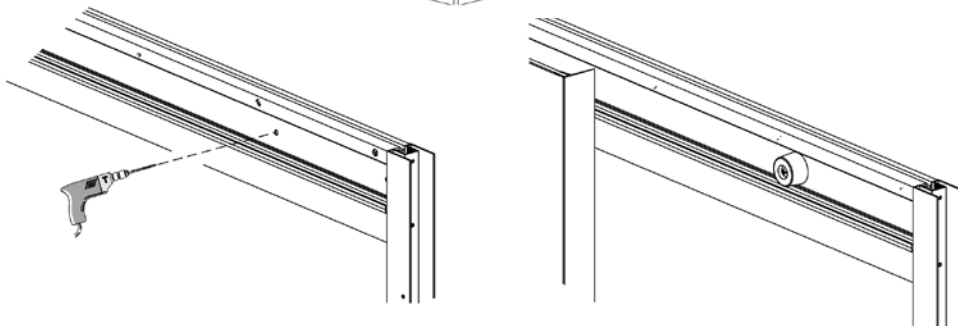
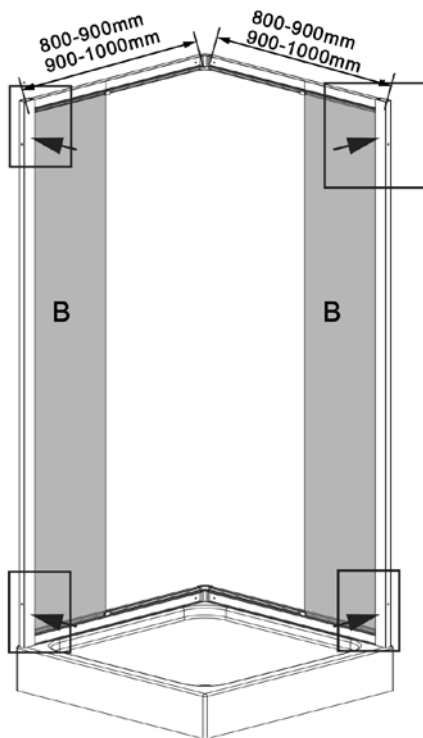

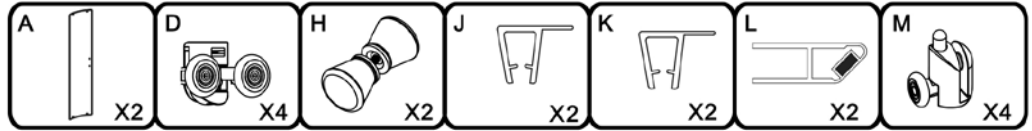

Étape 6

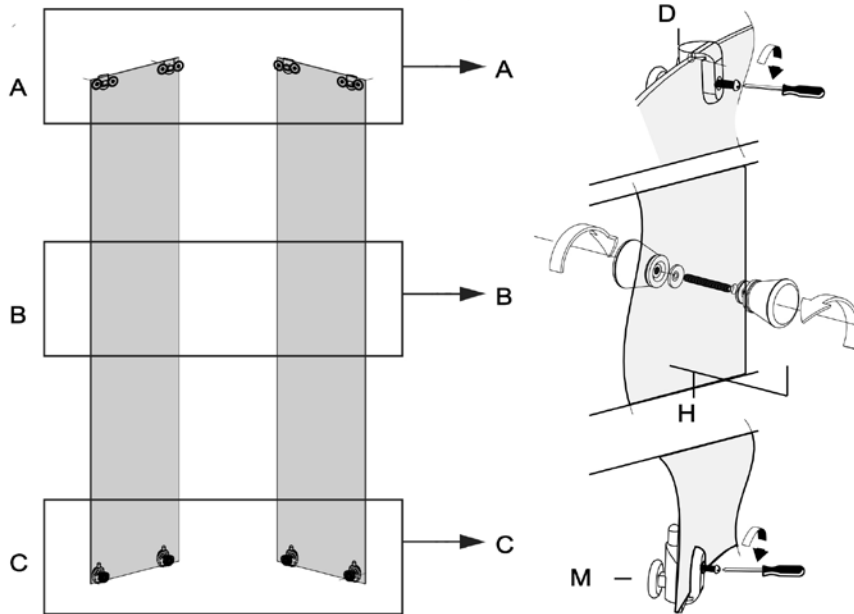

Étape 7

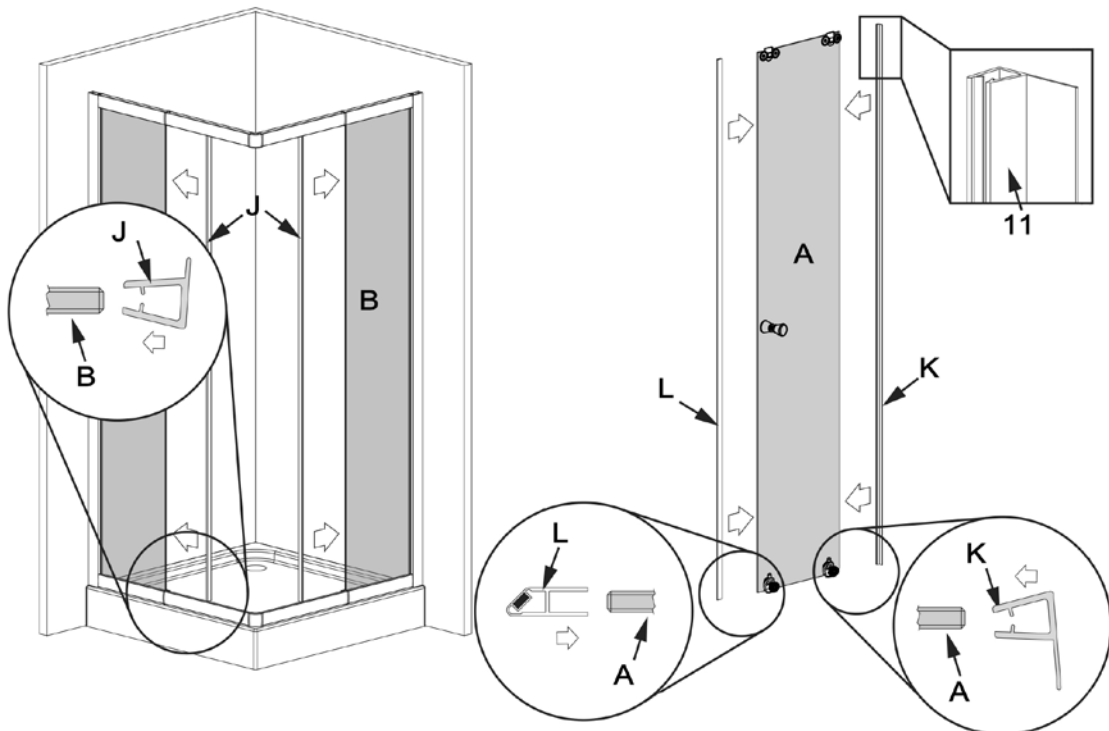

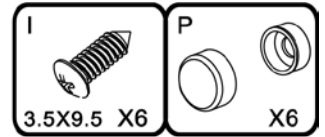
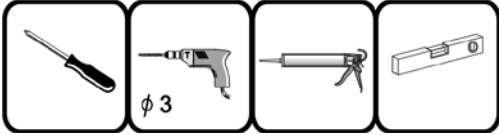

Étape 8

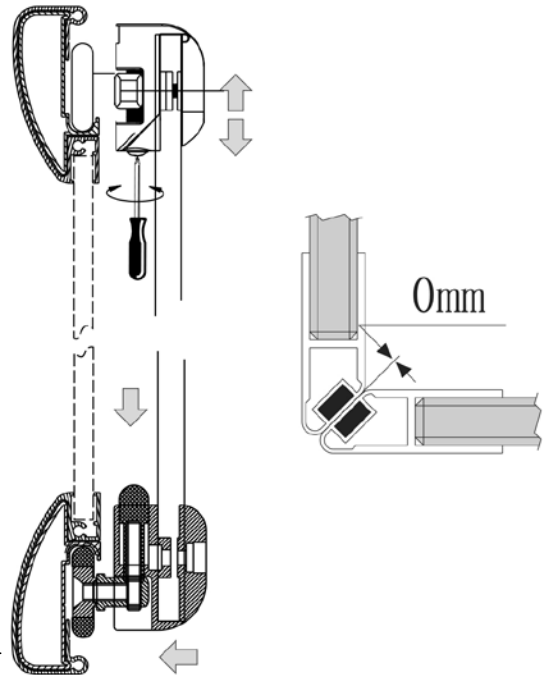
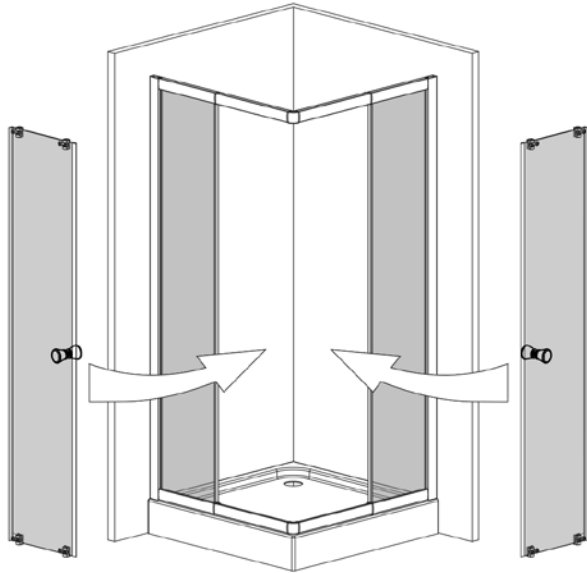

⚠ Assurez-vous que le profil mural est d'aplomb. À l'aide d'un niveau à bulle, placez la cabine de manière à ce qu'elle soit droite et à angle droit. Les galets doivent être montés de manière à ce que les portes se ferment de manière plane. Les portes doivent pouvoir être ouvertes et fermées sans effort.

Étape 9

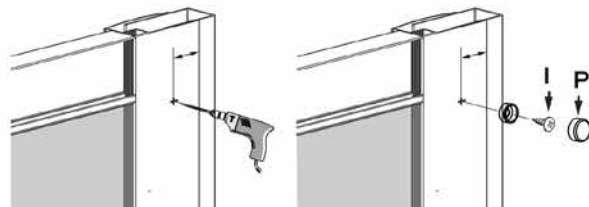
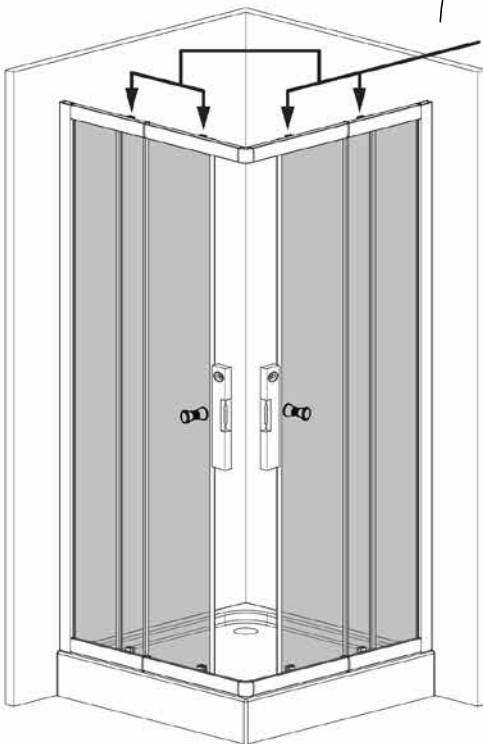

Étape 10

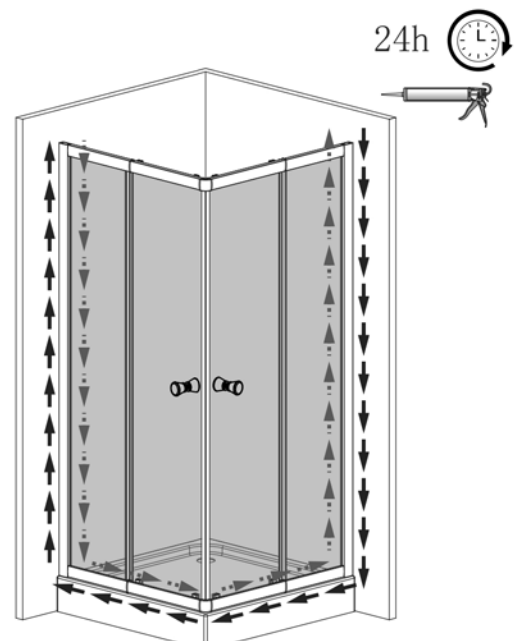

Traitement des déchets

Si cet article devient inutilisable, chaque utilisateur est légalement obligé de traiter les vieux appareils ménagers séparément des déchets domestiques, par exemple en les déposants dans un lieu de collecte de sa commune / de son quartier.

Notre service

Vous pourrez bénéficier immédiatement de conseils techniques en contactant notre équipe de services :

- **Allemagne** : téléphone 01806-63 06 30, depuis un poste fixe 20 c/appel, depuis un mobile
- **Autriche** : Universal: téléphone +43 / 662-4485 59, depuis un poste fixe en fonction de l'opérateur, conseil spécialisé bricolage – Otto: +43 / 316-606 159 depuis un poste fixe en fonction de l'opérateur, conseil spécialisé bricolage – Quelle: +43 / 662-9005 59 depuis un poste fixe en fonction de l'opérateur, conseil spécialisé
- **Suisse**, Quelle: **DE**: +41 / 848 85 85 00, **FR**: +41 / 848 85 85 01, I: +41 / 848 858 530
Ackermann: **DE**: +41 / 848 85 85 11, **FR**: +41 / 848 85 85 21, I: +41 / 848 858 530
- **Pays-Bas** : centre d'appel 0900-1901 (15 c/mn)

Pour nous permettre de vous aider aussi rapidement que possible, merci de préciser :

Le nom de l'article : Accès d'angle variable Trento

B8090 – 51194155 / 33331037
B8090WS – 70567511 / 39956613
B8090C – 68165331 / 28384669
B8090CS – 13717463 / 21371865
B8090B – 46713949 / 42547161
B8090BS – 86067306 / 75104752

et le **numéro d'article** sous lequel vous avez commandé cet article (voir facture).

Vous trouverez des informations relatives à la déclaration de performances (DoP) conformément à l'ordonnance européenne sur les produits de construction sur www.aproductZ.com.

La déclaration de performances (DoP) peut être consultée avec la référence article ou bien elle peut vous être envoyée par écrit sur simple demande.

Imported by AproductZ GmbH Werner-Otto-Str. 1 – 7 22179 Hamburg Germany

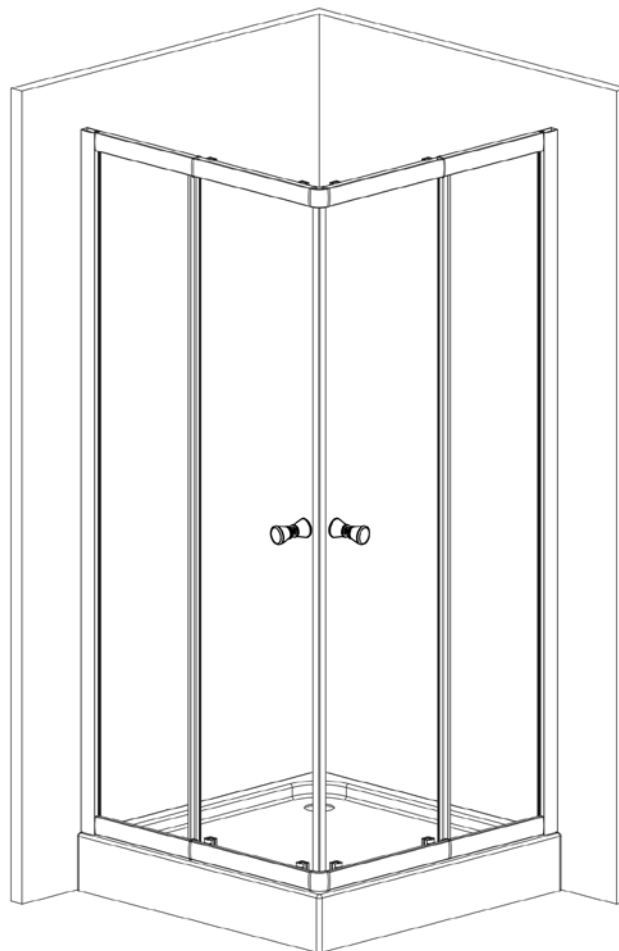

Entrata ad angolo variabile Trento

misure: 900 x 900 x 1800 mm

B8090 – 51194155 / 33331037
 B8090WS – 70567511 / 39956613
 B8090C – 68165331 / 28384669
 B8090CS – 13717463 / 21371865
 B8090B – 46713949 / 42547161
 B8090BS – 86067306 / 75104752



**Aufbauanleitung
 Duschekeinstieg**



**Istruzioni d'installazione
 Entrata ad angolo per doccia**



**Installation Instruction
 Square Shower**



**Montagehandleiding
 Hoekinstap douche**



**Instructions d'installation
 Cabine de douche accès d'angle**

D: Nachdruck, auch auszugsweise, nicht gestattet! **GB:** Reproduction, even in extracts, is not permitted! **F:** Toute reproduction de ce mode d'emploi même par extraits est interdite ! **IT:** È vietata la riproduzione, anche parziale. **NL:** Nadruk, ook slechts gedeeltelijk, niet toegestaan!

Istruzione n° 20160356



IMPORTANTE, CONSERVARE IL PRESENTE DOCUMENTO PER UN FUTURO RIFERIMENTO!
LEGGERE CON ATTENZIONE!

Uso conforme

- Il presente articolo è un'unità prefabbricata per la doccia.
- L'articolo è destinato esclusivamente all'uso privato.



Avvisi di sicurezza

- Pericolo di soffocamento / lesioni! L'imballaggio non è un giocattolo per bambini. Potrebbero soffocarsi con la pellicola o ferirsi con l'involucro.
- Fare attenzione che i bambini non mettano in bocca piccole parti quali bulloni, tappi ecc. L'ingerimento potrebbe comportare il soffocamento.
- Pericolo di danneggiamento! Prima del montaggio, leggere attentamente le istruzioni di montaggio e accertarsi dell'assenza di danni da trasporto. Installare l'articolo con la massima cura.
- Il montaggio dell'articolo è consentito solo alle persone esperte. Si consiglia di effettuare il montaggio con l'aiuto di una seconda persona.
- Pericolo di lesioni! Durante il montaggio, fare attenzione ai bordi taglienti di alcune parti.
- Montare l'articolo esclusivamente a ridosso di una parete adatta e massiccia.
- **Attenzione:** Il fissaggio dell'arredo alla parete va effettuato da una persona esperta, dato che il montaggio richiede l'utilizzo di tasselli adatti alla parete.
- Accertarsi dell'assenza di cavi e tubi nei punti di perforazione.
- Controllare la parete con un cercametalli prima di effettuare i fori.
- Prestare attenzione alle superfici in vetro! Tenerle ben salde durante la il loro montaggio per evitare che cadano.
- Impermeabilizzare la parete della doccia all'esterno con del silicone. Dopo l'impermeabilizzazione, attendere 24 ore prima dell'utilizzo della doccia.
- Per l'allacciamento della vasca alla rete di scarico, si consiglia di utilizzare un sifone normale con un tubo di scarico flessibile
- Per ordinare le parti di ricambio (ved. lista dei ricambi) si prega di rivolgersi al servizio clienti.

Avvisi per la pulizia

Pulire le superfici in vetro con un panno morbido e detergente per vetro e asciugarle successivamente con un panno asciutto. Sono sufficienti i detersivi ecologici e/o delicati.

Si sconsiglia l'utilizzo di detersivi aggressivi o contenenti solventi.

Non utilizzare oggetti taglienti, lana d'acciaio, agenti chimici o abrasivi contenenti sabbia. Potrebbero danneggiare le superfici e comportare di conseguenza la decadenza della garanzia. Le incrostazioni leggere di calcare si possono rimuovere facilmente con dell'aceto.

Attrezzi necessari

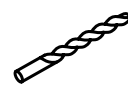
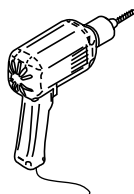
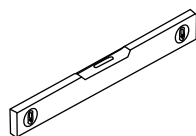
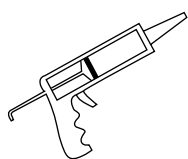

Ø 6mm

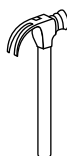
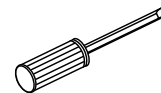

Ø 3.2mm

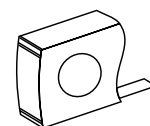
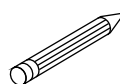
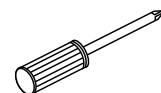

L'elevato peso del prodotto potrebbe rendere necessario l'aiuto di una seconda persona per il montaggio

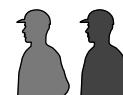

Contenuto della confezione

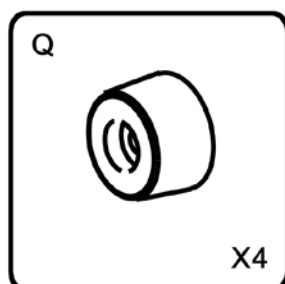
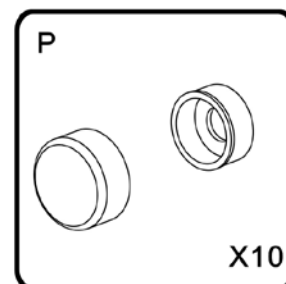
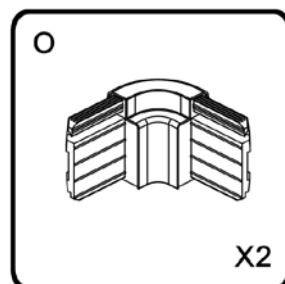
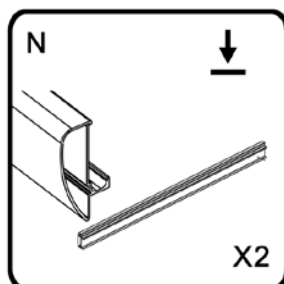
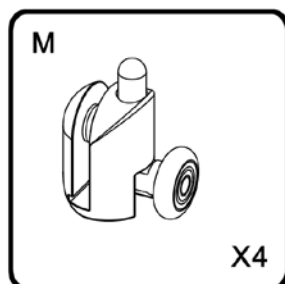
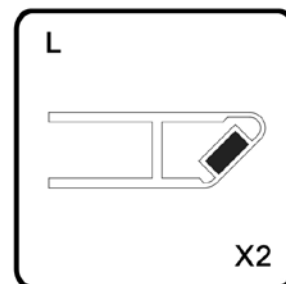
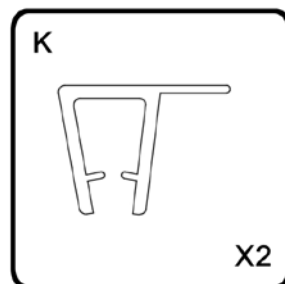
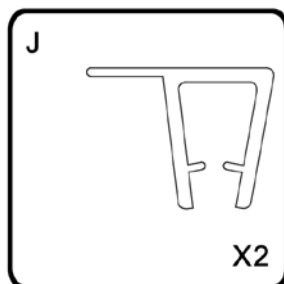
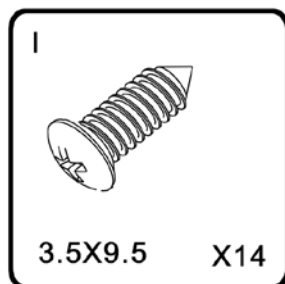
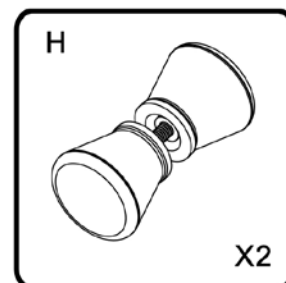
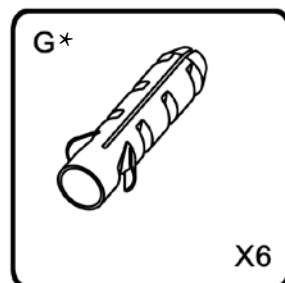
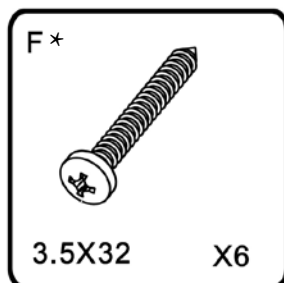
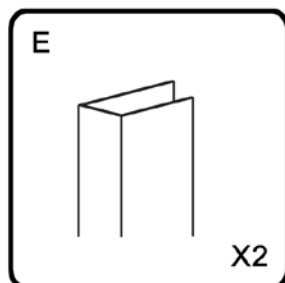
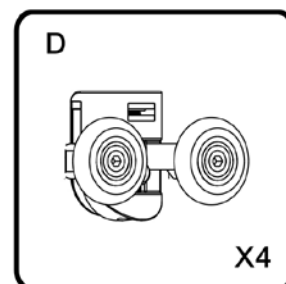
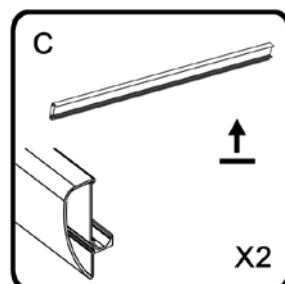
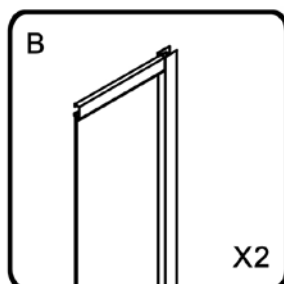
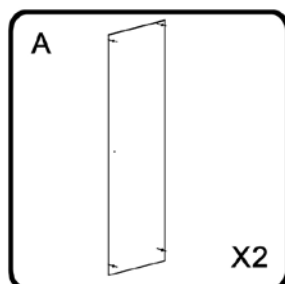
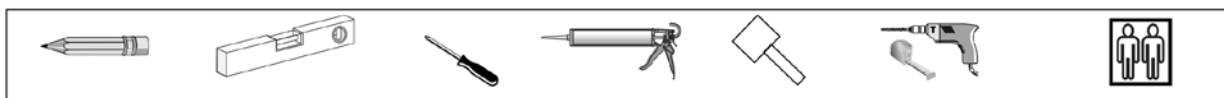

* non compresi

Schema di montaggio

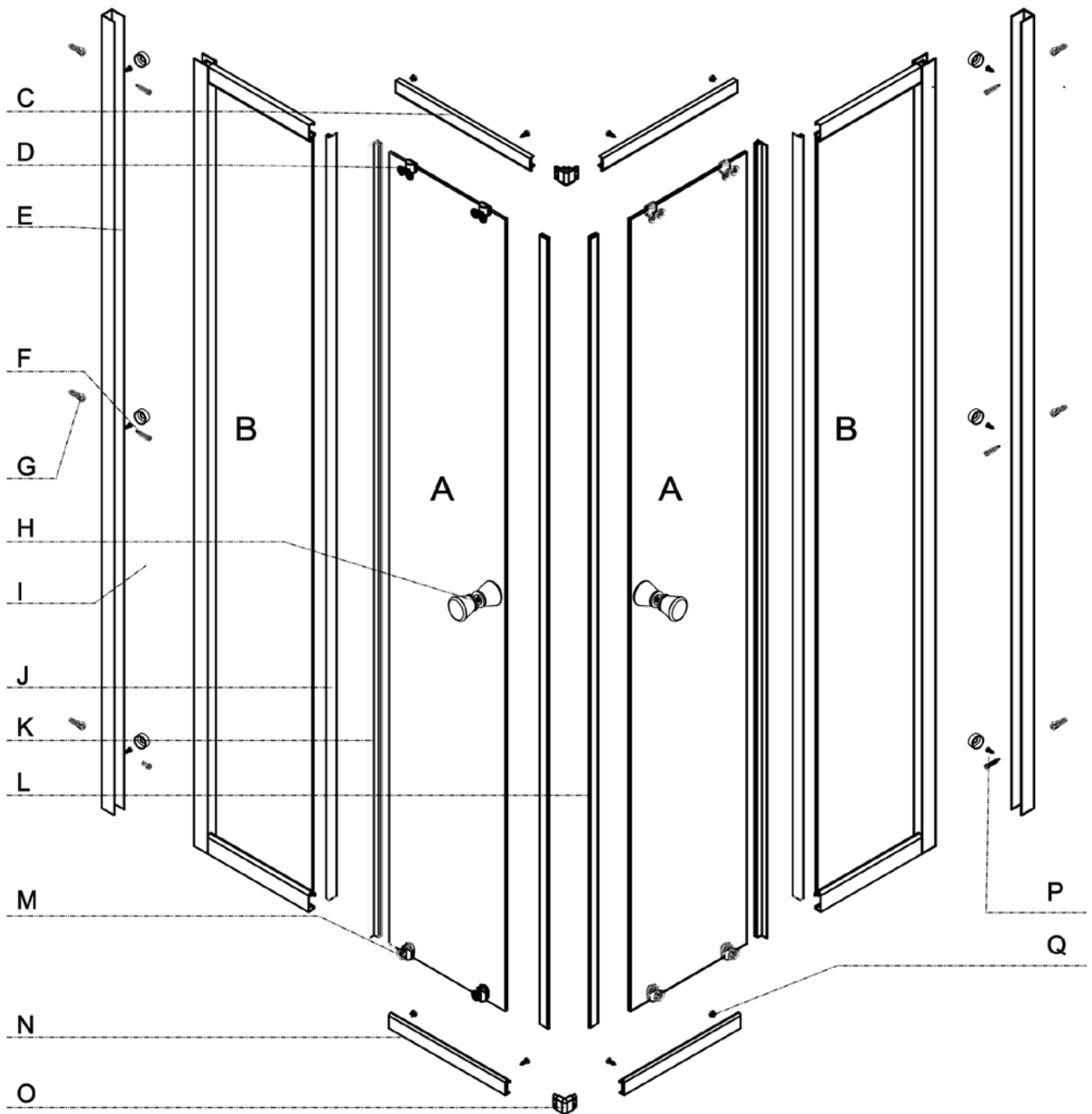

Fasi di montaggio

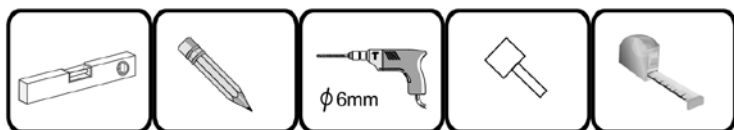

* non compresi

Fase 1

- Allineare il piatto doccia alle pareti verticali con un angolo di 90 gradi con l'aiuto di una bolla
- Coprire le giunture con del silicone. Scegliere il silicone in base ai materiali utilizzati; osservare i tempi di indurimento.

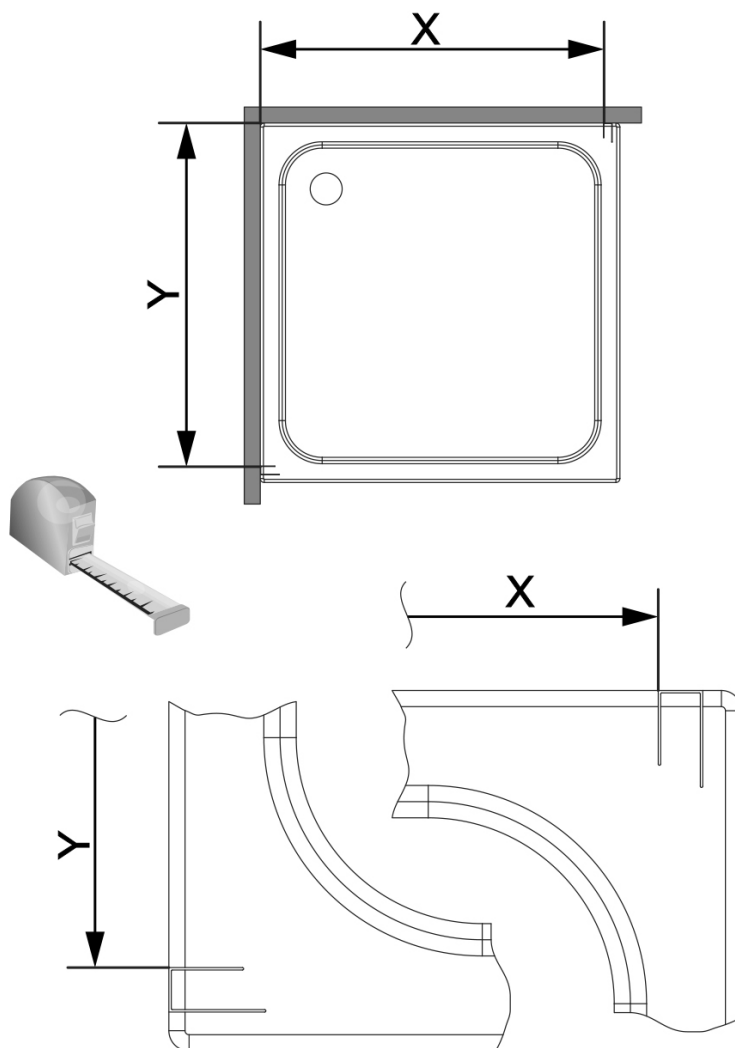

Fase 2

Allineare la cornice con l'aiuto di una bolla. Segnare i punti dei fori per il fissaggio. Montare la cornice alla parete secondo le indicazioni delle figure

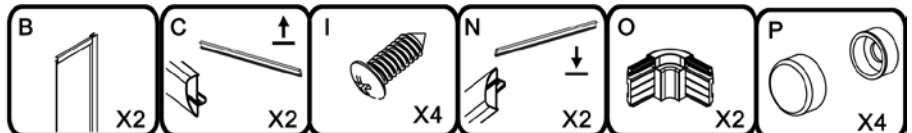
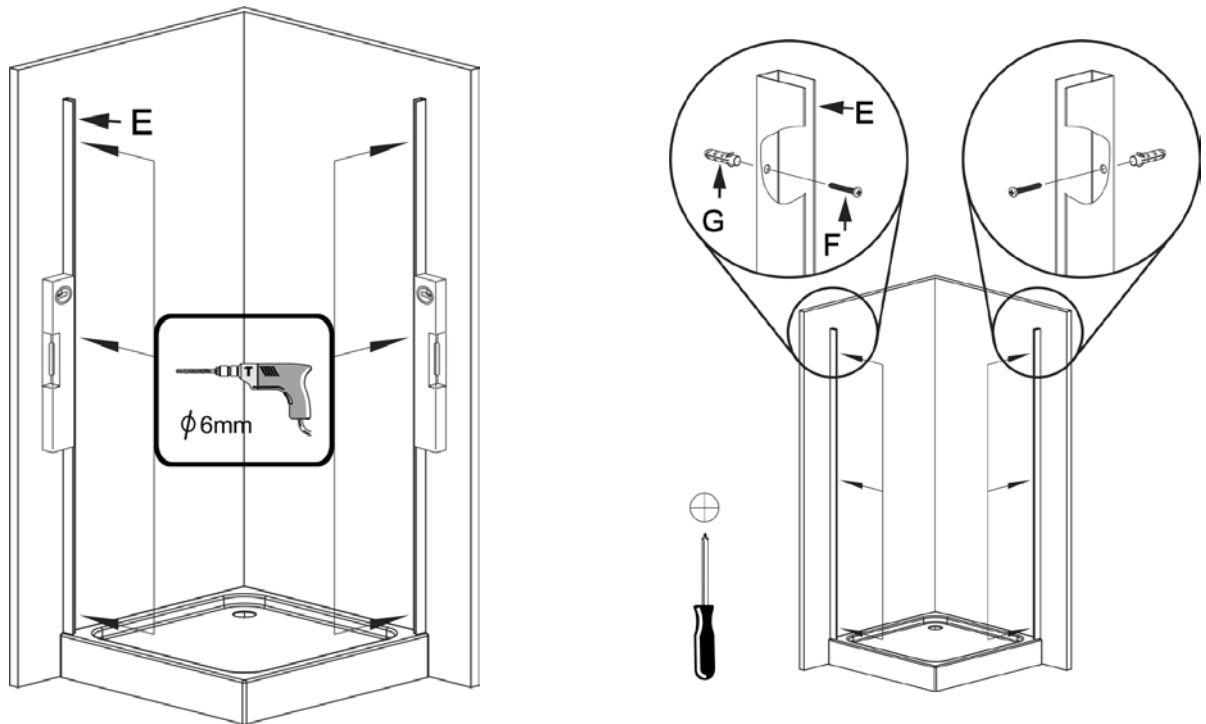

Fase 3

Collegare i giunti ad angolo avvitandoli in alto e in basso.

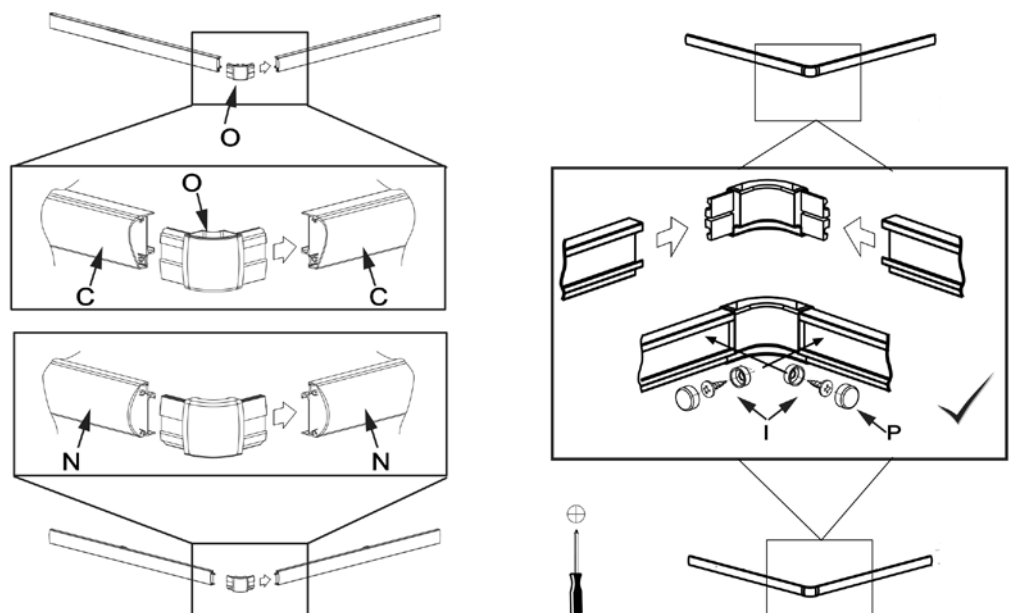

Fase 4

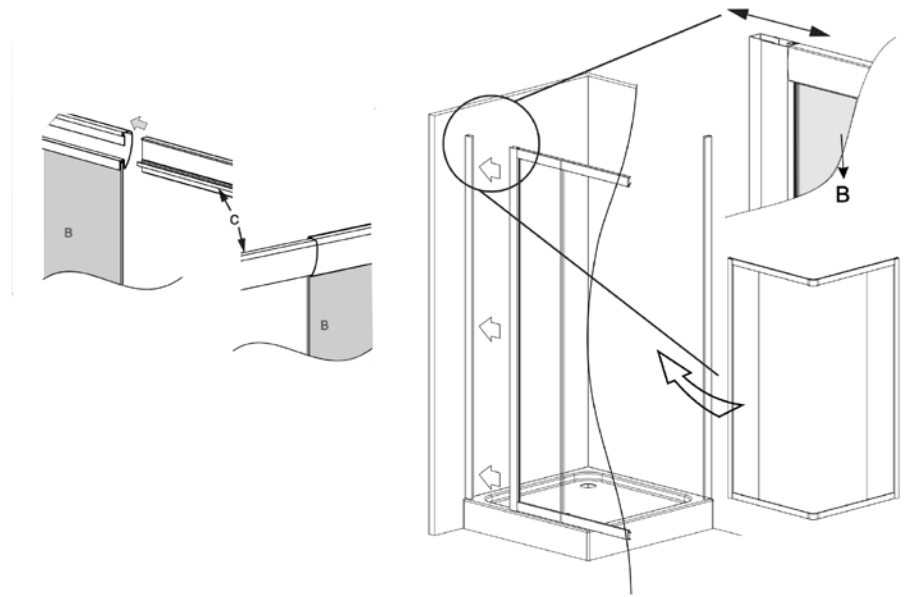
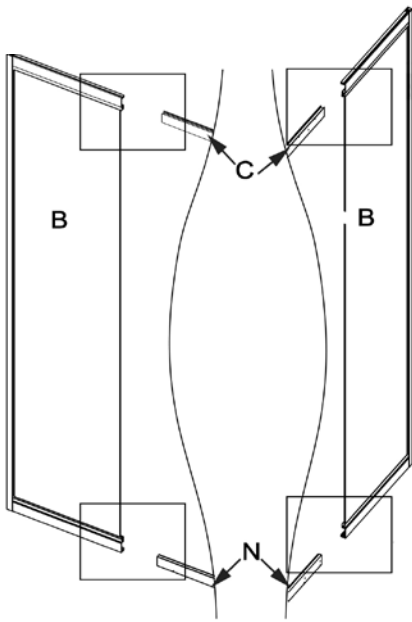

Fase 5

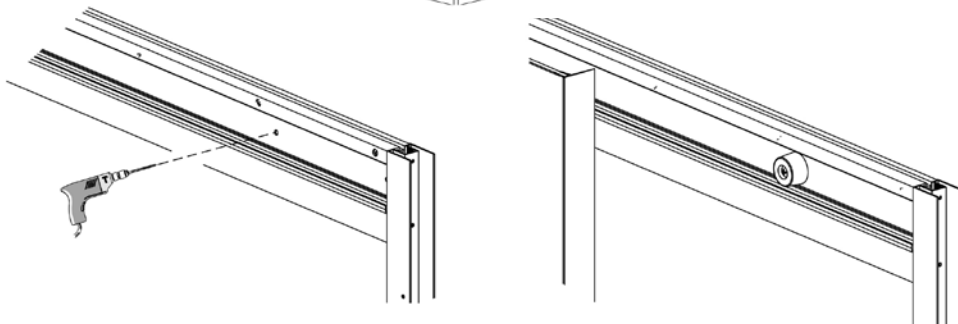
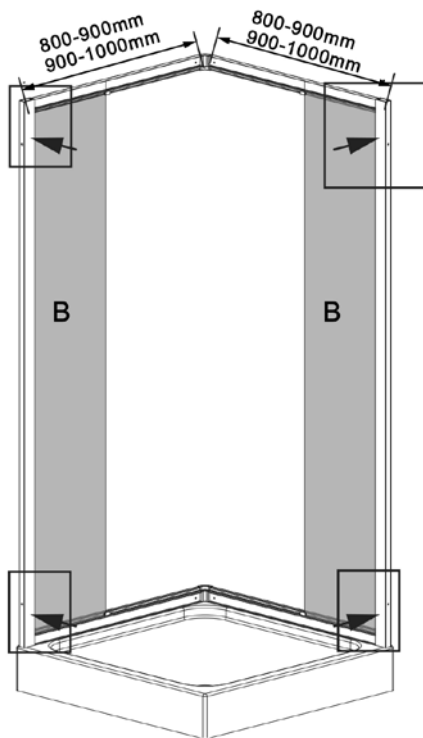

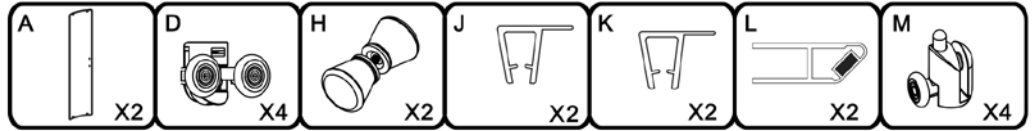

Fase 6

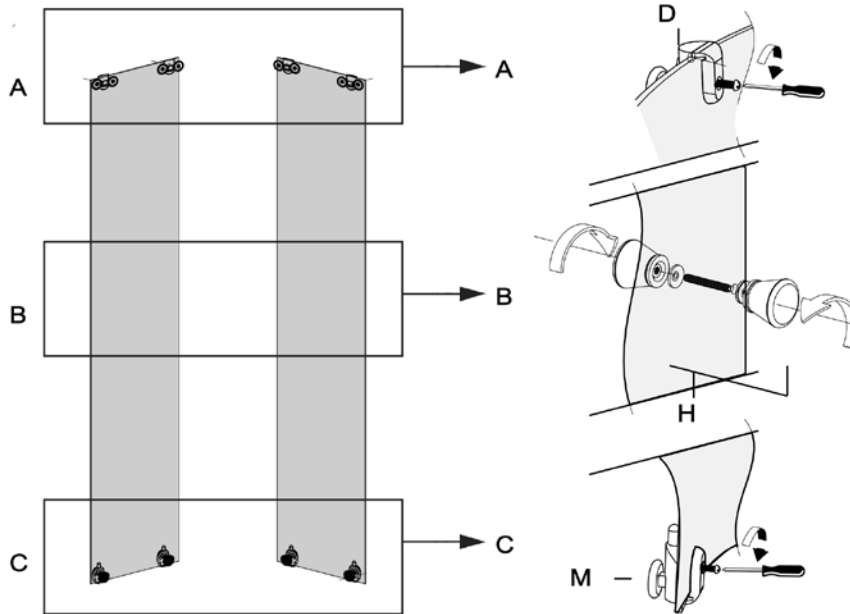

Fase 7

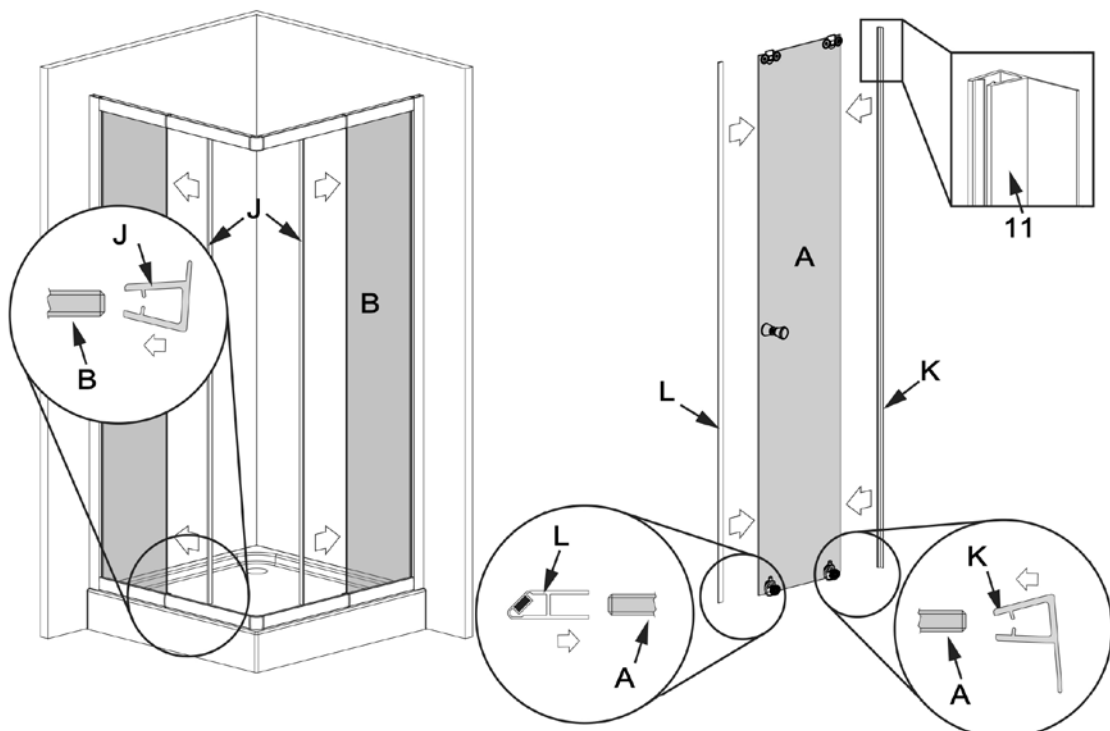

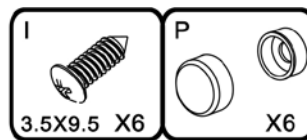
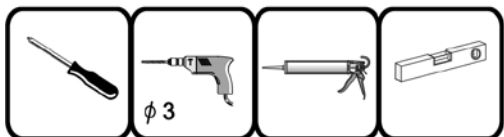

Fase 8

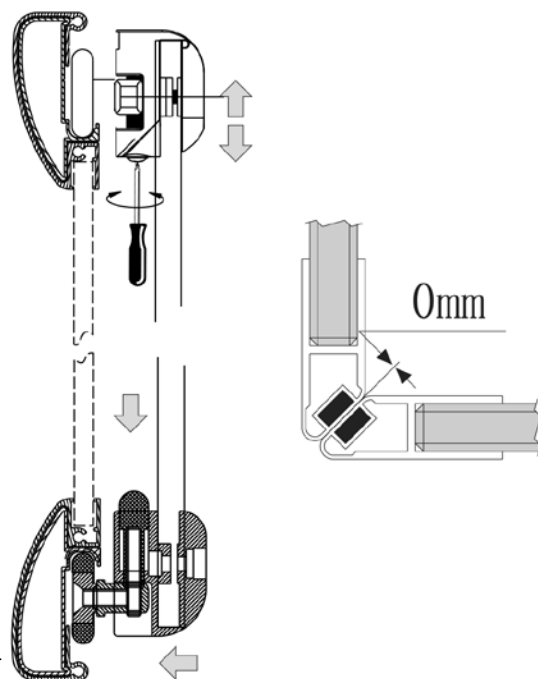
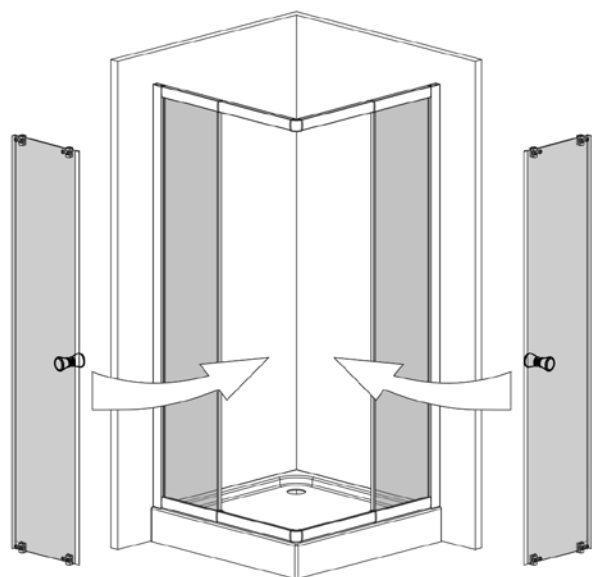

! Accertarsi che i profil a muro siano a bolla. Allineare la cabina con l'aiuto di una bolla per garantire che sia dritta e con gli angoli retti. Le rotelle dovrebbero essere montate in modo da assicurare che la porta chiuda perfettamente e si apra e chiuda senza fatica.

Fase 9

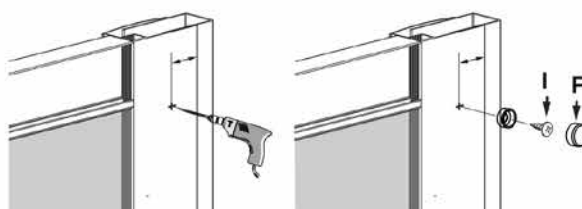
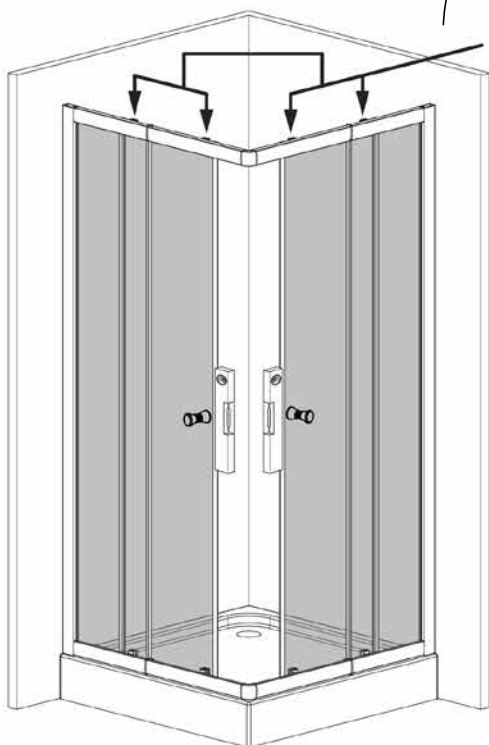

Fase 10

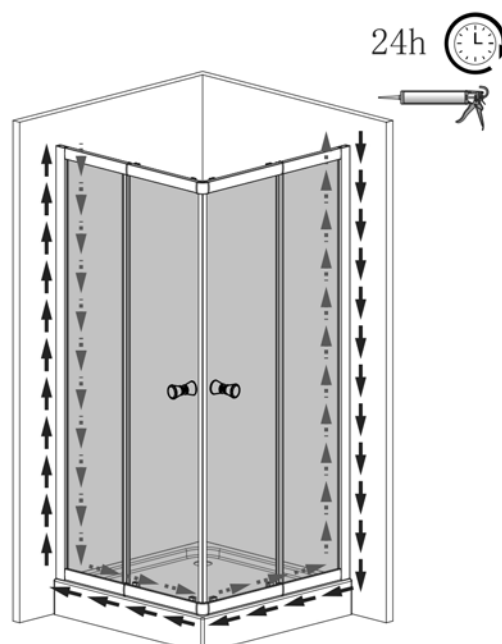

Smaltimento

Qualora l'articolo non dovesse più servire, ogni consumatore è obbligato per legge allo smaltimento separato delle vecchie apparecchiature consegnandole ad esempio all'ecocentro del proprio comune / quartiere.

Il nostro servizio

Il nostro team di servizio vi offre una rapida consulenza specialistica:

- **Germania:** telefono 01806-63 06 30, rete fiss 20ct/chiamata, telefonia mobile max. 60 ct/chiamata
- **Austria, Universal:** telefono +43 / 662-4485 59, rete fiss a secondo del gestore, consulenza specialistica per il fai da te – Otto: +43 / 316-606 159 rete fiss a secondo del gestore, consulenza specialistica per il fai da te – Quelle: +43 / 662-9005 59 rete fiss a secondo del gestore, consulenza specialistica per il fai da te
- **Svizzera, Quelle:** **DE:** +41 / 848 85 85 00, **FR:** +41 / 848 85 85 01, **I:** +41 / 848 858 530
Ackermann: **DE:** +41 / 848 85 85 11, **FR:** +41 / 848 85 85 21, **I:** +41 / 848 858 530
- **Paesi bassi,** call center 0900-1901 (15ct/min.)

Per poter garantire un celere aiuto, si prega di indicare:
Il nome dell'articolo: Entrata ad angolo variabile Trento

B8090 – 51194155 / 33331037
B8090WS – 70567511 / 39956613
B8090C – 68165331 / 28384669
B8090CS – 13717463 / 21371865
B8090B – 46713949 / 42547161
B8090BS – 86067306 / 75104752

e il **codice articolo** con il quale avete ordinato l'articolo (ved. scontrino).

Informazioni sulla dichiarazione di prestazione (DoP) ai sensi dell'Ordinanza sui prodotti edilizi UE sono riportate in www.aproductZ.com

La dichiarazione di prestazione può essere richiesta sulla base del codice articolo. Inoltre è possibile richiedere e ricevere per posta la forma cartacea della dichiarazione di prestazione (DoP).

Imported by AproductZ GmbH Werner-Otto-Str. 1 – 7 22179 Hamburg Germany

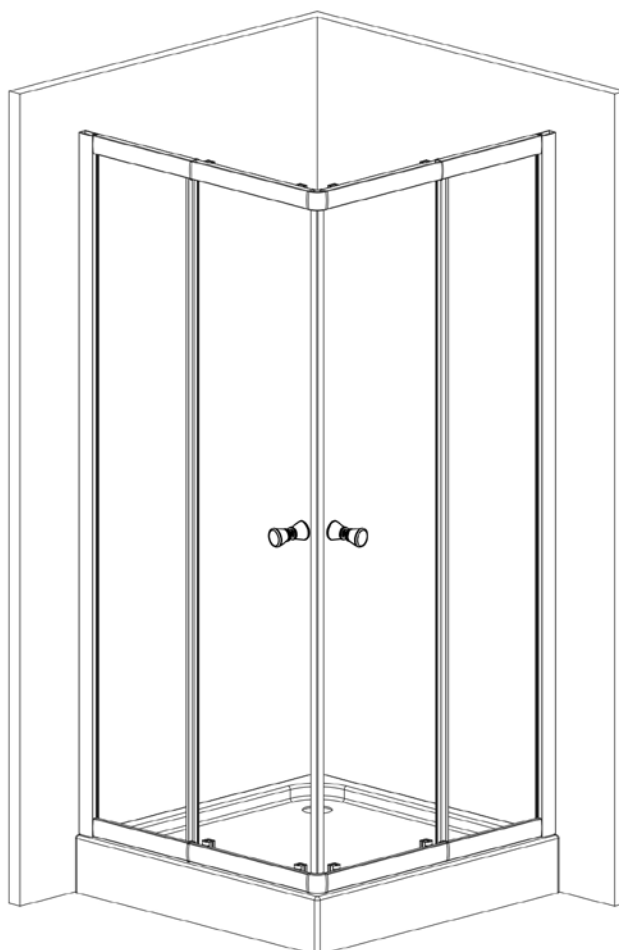

Variabele hoekinstap Trento

Afmetingen: 900 x 900 x 1800 mm

B8090 – 51194155 / 33331037
 B8090WS – 70567511 / 39956613
 B8090C – 68165331 / 28384669
 B8090CS – 13717463 / 21371865
 B8090B – 46713949 / 42547161
 B8090BS – 86067306 / 75104752

D

**Aufbauanleitung
 Duschekeinstieg**

I

**Istruzioni d'installazione
 Entrata ad angolo per doccia**

GB

**Installation Instruction
 Square Shower**

NL

**Montagehandleiding
 Hoekinstap douche**

F

**Instructions d'installation
 Cabine de douche accès d'angle**

D: Nachdruck, auch auszugsweise, nicht gestattet! GB: Reproduction, even in extracts, is not permitted! F: Toute reproduction de ce mode d'emploi même par extraits est interdite ! IT: È vietata la riproduzione, anche parziale. NL: Nadruk, ook slechts gedeeltelijk, niet toegestaan!

Instructie nr. 20160356

**BELANGRIJK, BEWAAR DIT DOCUMENT VOOR EVENTUELE TOEKOMSTIGE RAADPLEGING!
ZORVULDIG LEZEN!**

Beoogd gebruik

- Dit artikel is een geprefabriceerde cabine om te douchen.
- Dit artikel is uitsluitend bedoeld voor privégebruik.



Veiligheidsadvies

- Verstikkingsgevaar en risico op letsel! Laat uw kinderen nooit met de verpakking spelen. Ze zouden in het plastic kunnen stikken en zich aan de verpakking kunnen verwonden.
- Let er op dat kinderen geen kleine onderdelen zoals moeren, doppen of iets dergelijks in hun mond nemen. Bij inslikken bestaat er een risico op verstikking.
- Risico op schade! Lees de handleiding voor het monteren nauwkeurig door en controleer het product op eventuele transportschade. Wees zorgvuldig bij het monteren van het artikel.
- Het artikel mag uitsluitend door vakmensen worden gemonteerd. Het verdient aanbeveling om de montage door twee personen te laten uitvoeren.
- Risico op letsel! Let er bij de montage op dat sommige onderdelen scherpe randen hebben.
- Monteer het artikel uitsluitend aan een daarvoor geschikte, massieve muur.
- **Let op:** De wandmontage van dit meubelstuk moet door een deskundige persoon worden uitgevoerd, daar voor de wandmontage speciale pluggen nodig zijn.
- Ga na of er op de plekken waar geboord wordt geen kabels of leidingen lopen.
- Controleer die plekken voor het boren met een metaaldetector.
- Wees voorzichtig met de glasplaten! Houd de glasplaten bij het monteren goed vast, zodat ze niet vallen.
- Dicht de douchewanden van buiten af met siliconenkit. Wacht na het afdichten minimaal 24 uur om de douche te gebruiken.
- Om de douchebak op de eigen afvoer aan te sluiten, dient u een normaal verkrijgbare sifon met een flexibel afvoerslang te gebruiken.
- Neem voor het bestellen van onderdelen (zie onderdelenlijst) contact op met de klantenservice.

Onderhoudsadvies

Reinig de glasplaten met een vochtige doek en een beetje glasreiniger en droog na met een droge doek. Milieuvriendelijke en milde huishoudelijke schoonmaakmiddelen zijn al voldoende. Gebruik in geen geval agressieve of oplosmiddelhoudende schoonmaakmiddelen. Gebruik in geen geval scherpe voorwerpen, staalwol, chemicaliën of zandhoudende schuurmiddelen voor de reiniging. Dit kan leiden tot schade aan het oppervlak en het vervallen van de garantie. Lichte kalkaanslag kunt u zonder problemen met een kleine hoeveelheid huishoudazijn verwijderen.

Benodigd gereedschap

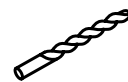
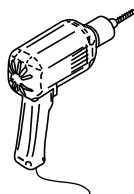
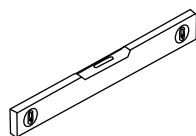
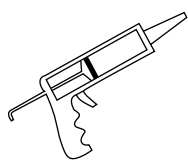

Ø 6mm

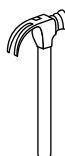
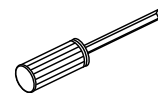

Ø 3.2mm

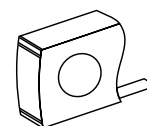
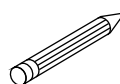
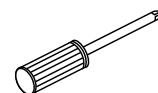

Vanwege het gewicht van dit product zijn er mogelijk twee personen nodig voor de montage.

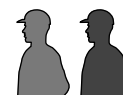

Inhoud

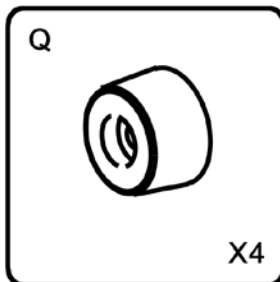
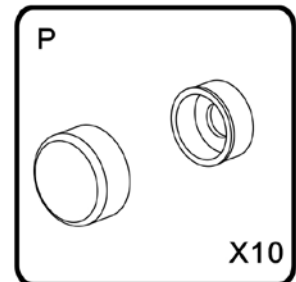
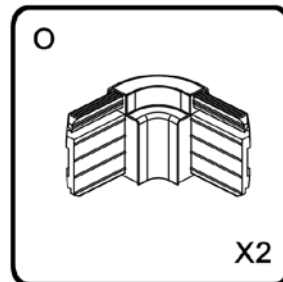
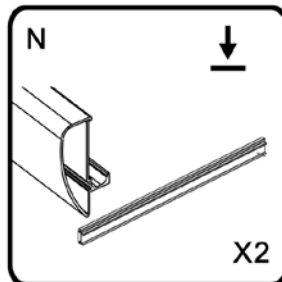
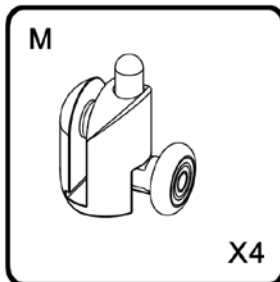
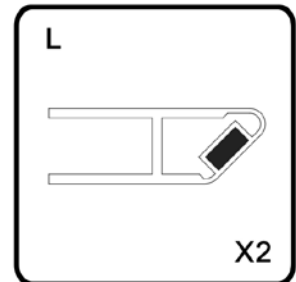
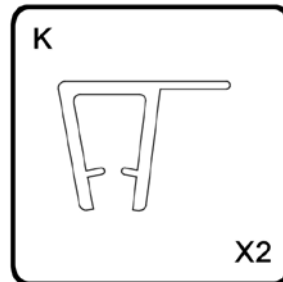
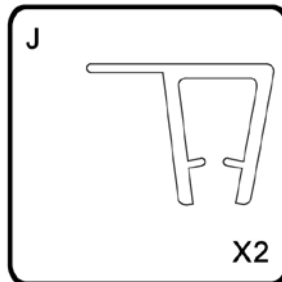
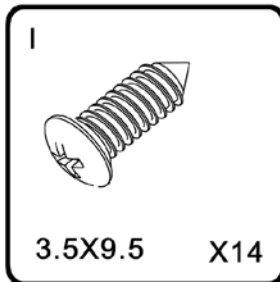
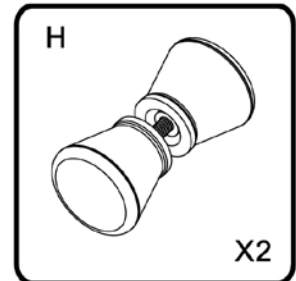
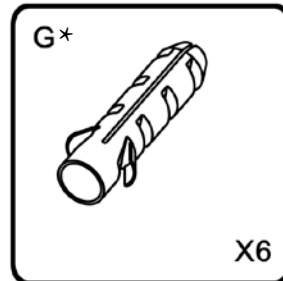
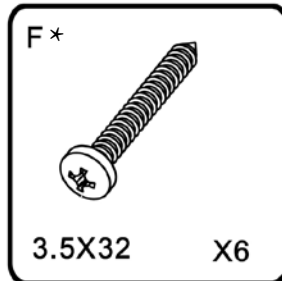
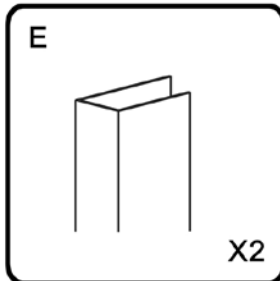
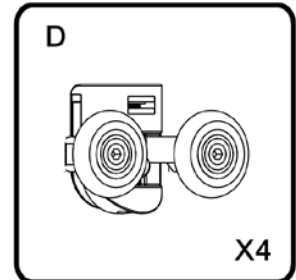
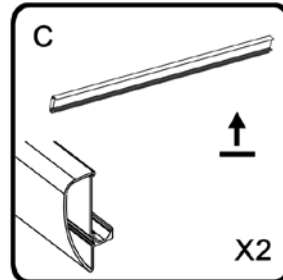
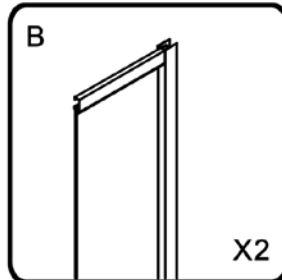
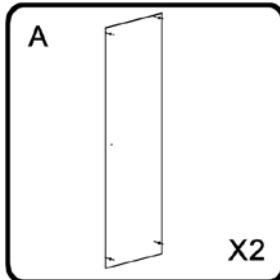
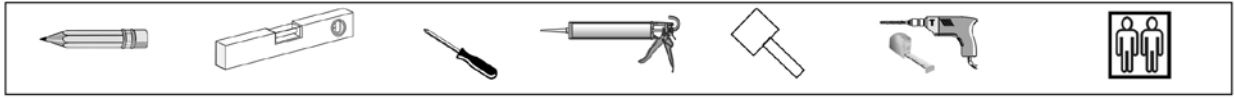

* niet inbegrepen

Montagetekening

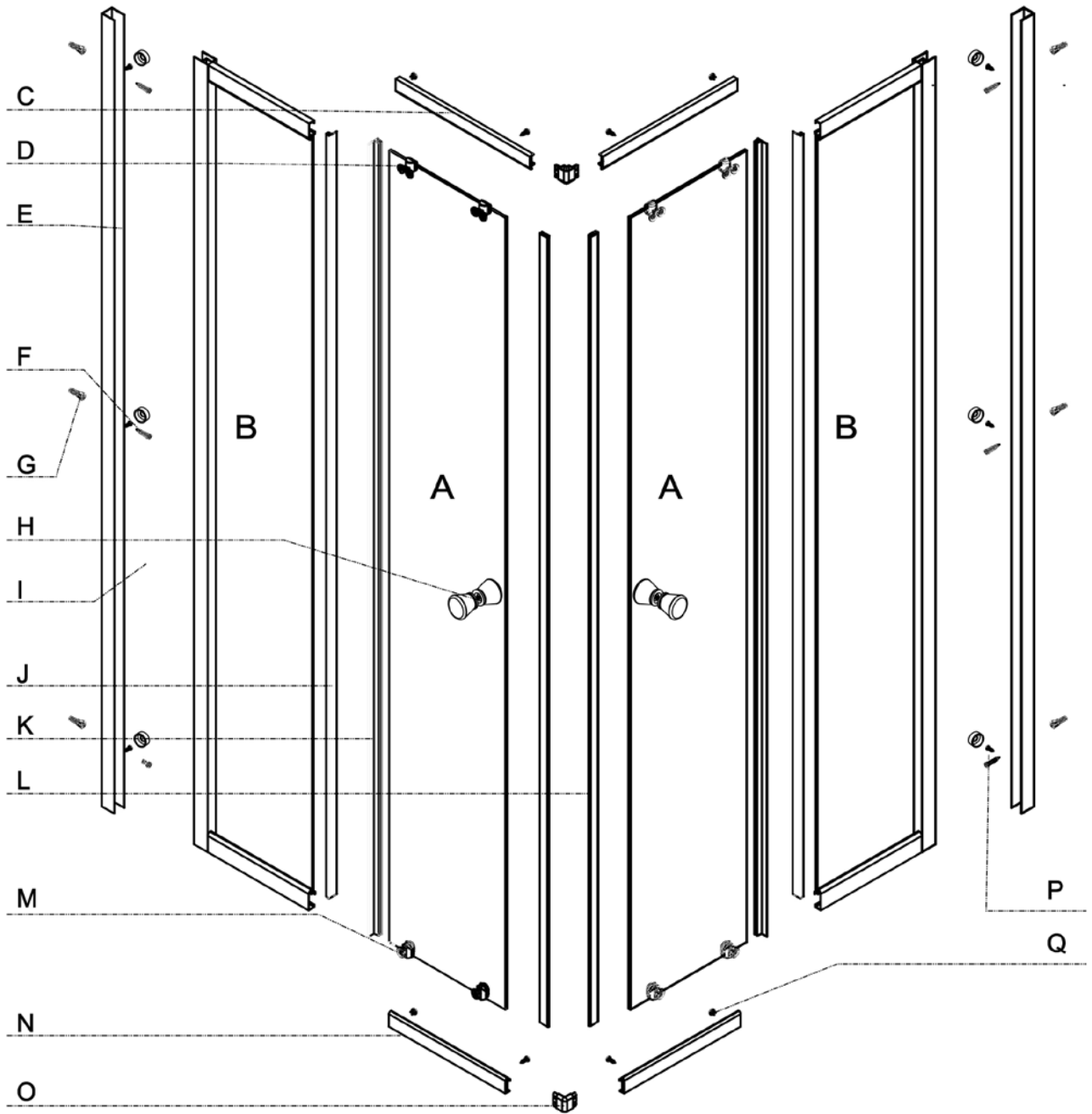

Montagestappen



* niet inbegrepen

Stap 1

- De douchebak dient op loodrechte muren in een hoek van 90 graden met behulp van een waterpas te worden uitgelijnd.
- De voegen dienen met siliconenkit te worden gedicht. Gebruik een siliconenkit die geschikt is voor de gebruikte bouwmaterialen en let op de uithardtijd.

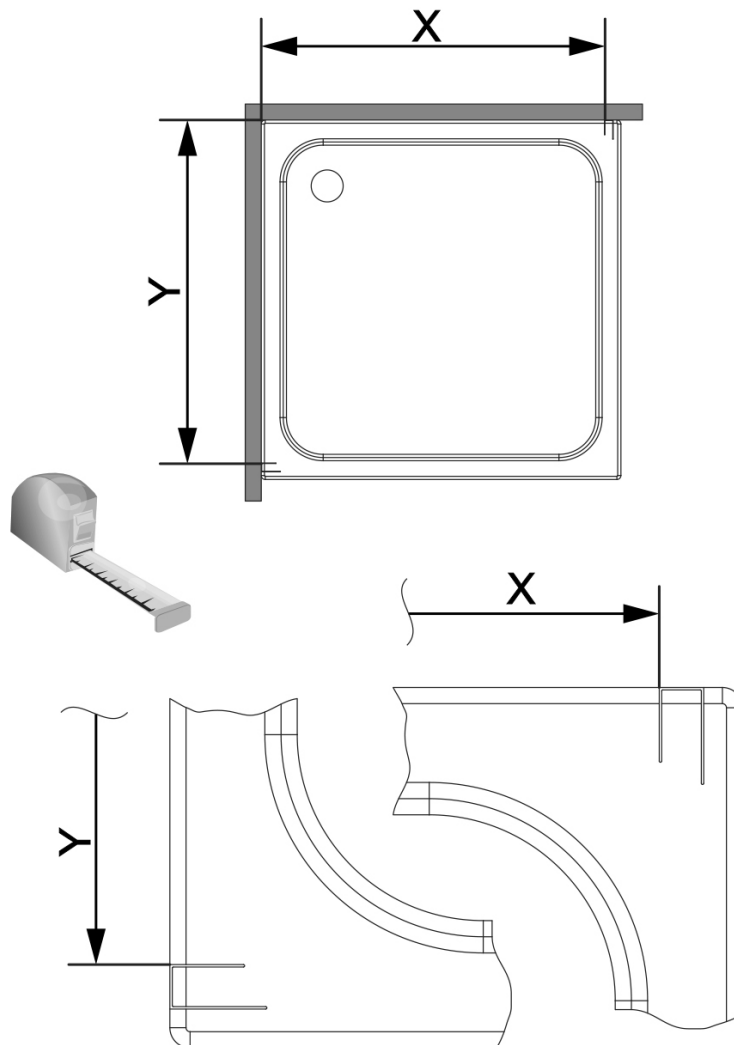

Stap 2

Lijn het frame uit met de waterpas. Markeer de bevestigingsgaten op de muur. Bevestig het frame, zoals op pictogrammen aangegeven, aan de muur.

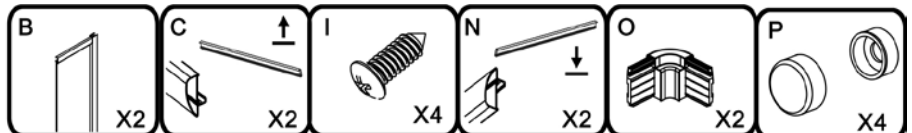
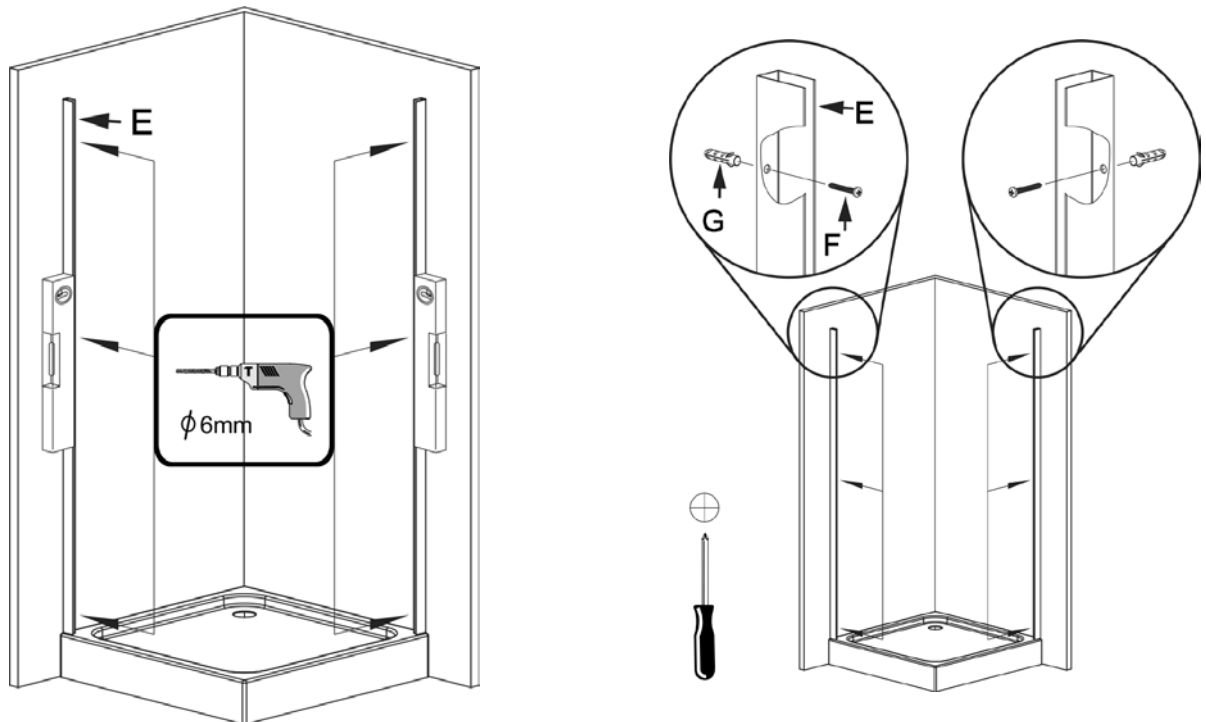

Stap 3

Steek de hoekverbindingen overeenkomstig samen en schroef deze onderaan en bovenaan vast.

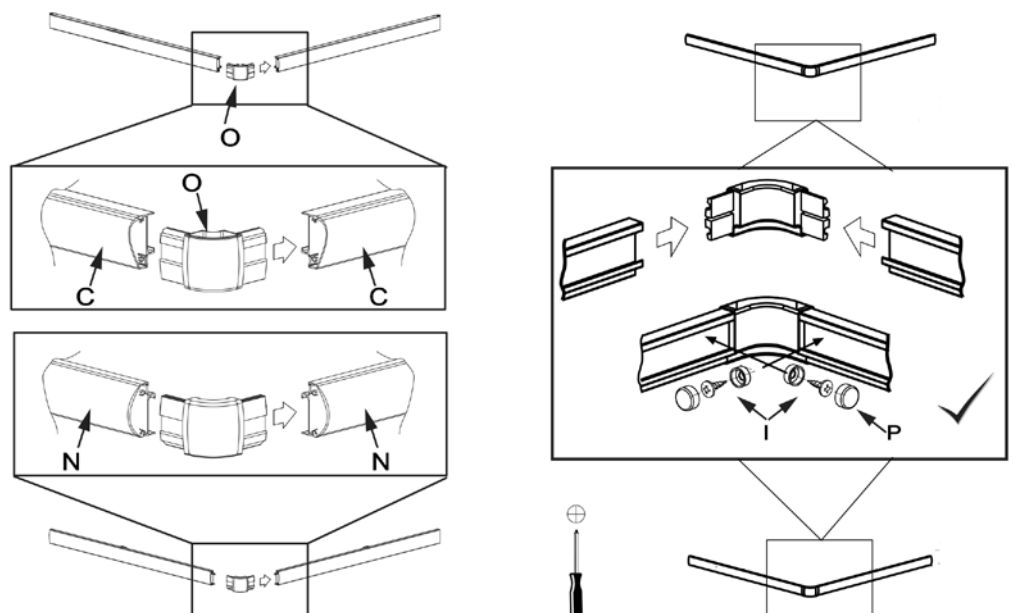

Stap 4

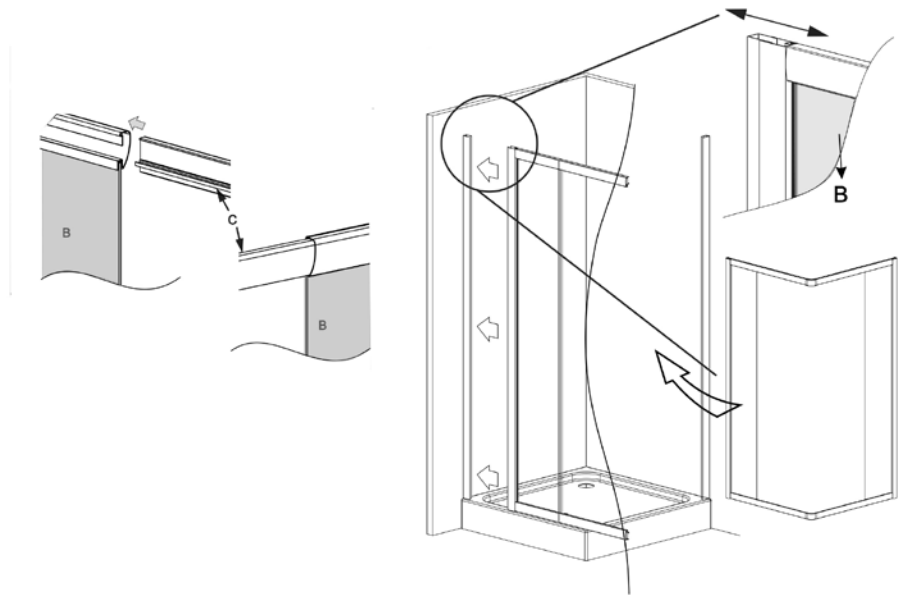
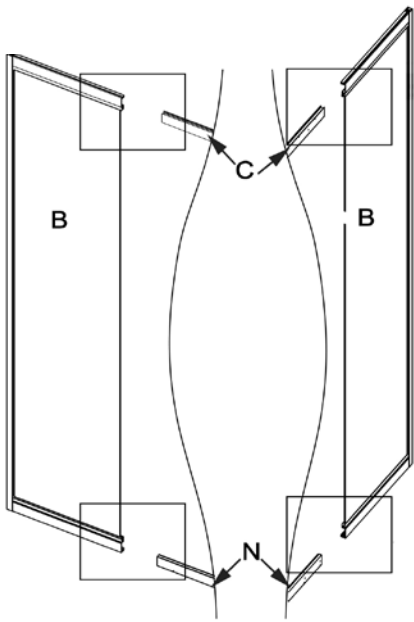

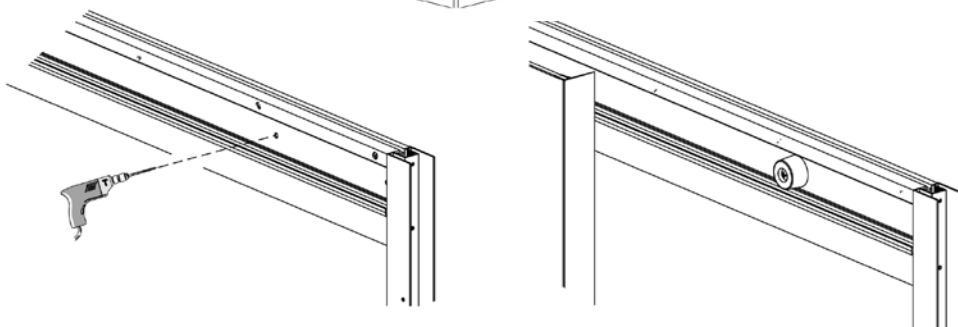
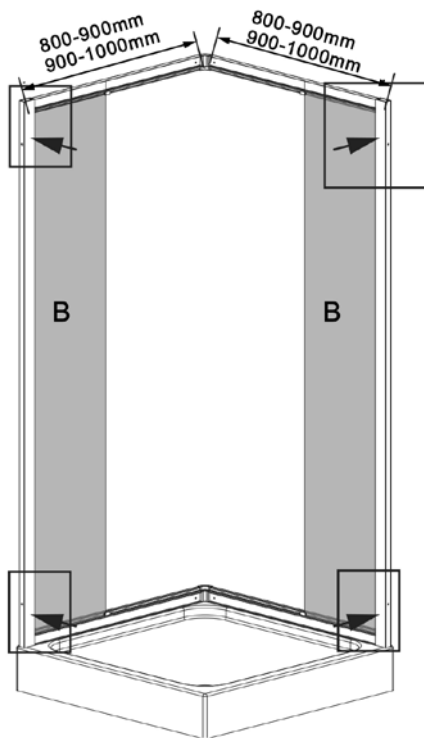

Stap 5

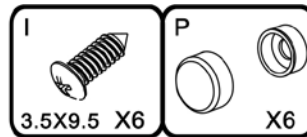
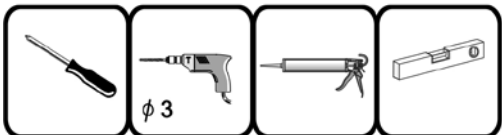

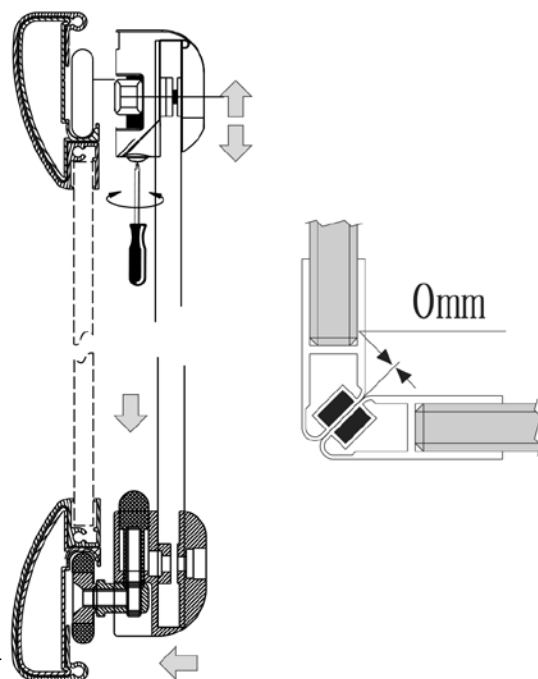
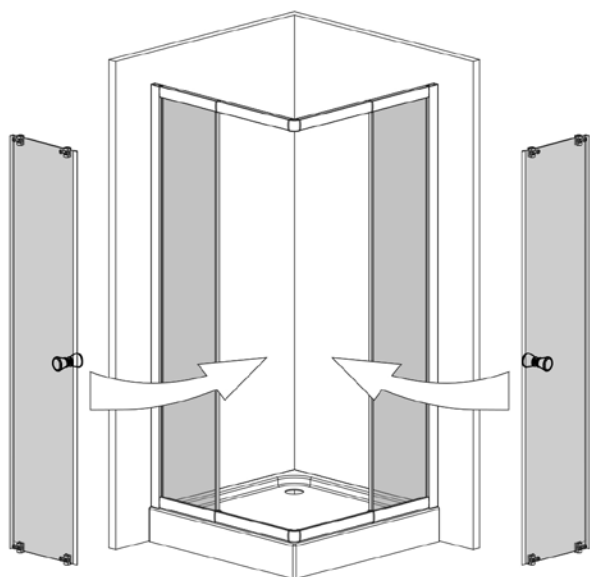

Stap 8



 Zorg ervoor dat de wandprofielen loodrecht staan. Lijn de cabine zodanig uit met een waterpas dat deze rechte hoeken heeft en recht is. De wieltjes moeten zodanig zijn aangebracht dat de deuren volledig naadloos aansluiten en moeiteloos open en dicht gaan.

Stap 9

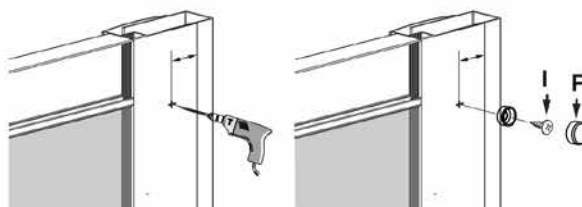
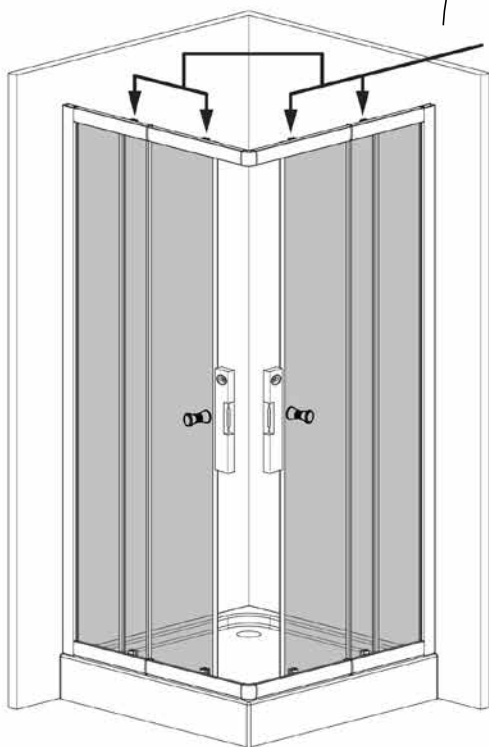

Stap 10

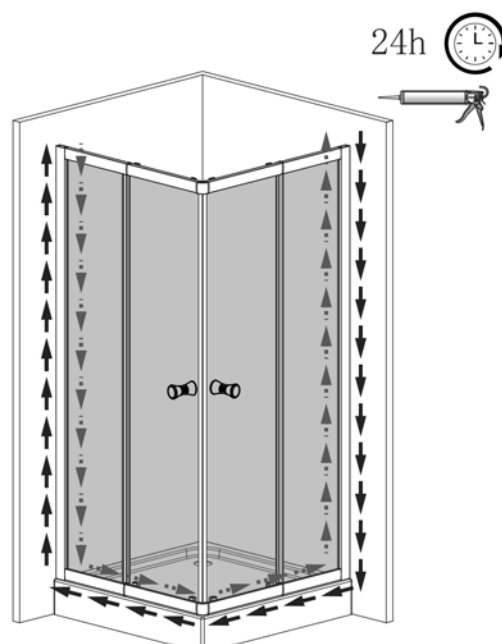

Afvalverwijdering

Indien dit product niet meer gebruikt wordt, is elke consument wettelijk verplicht om dergelijke huisraad apart van het huisvuil te verwijderen en bijv. bij de gemeente/milieustraat in te leveren.

Onze service

Ons serviceteam staat u onmiddellijk vakkundig te woord:

- **Duitsland:** Telefoon 01806-63 06 30, Vaste lijn 20ct/gesprek, Mobiel max. 60 ct/gesprek
- **Oostenrijk,** Universal: Telefoon +43 / 662-4485 59, Vaste lijn afhankelijk van aanbieder, Service afd. Doe-het-zelf - Otto: +43 / 316-606 159 - , Vaste lijn afhankelijk van aanbieder, Service afd. Doe-het-zelf - Quelle: +43 / 662-9005 59, Vaste lijn afhankelijk van aanbieder, Service afd. Doe-het-zelf
- **Zwitserland,** Quelle: **DE:** +41 / 848 85 85 00, **FR:** +41 / 848 85 85 01, **I:** +41 / 848 858 530
Ackermann: **DE:** +41 / 848 85 85 11, **FR:** +41 / 848 85 85 21, **I:** +41 / 848 858 530
- **Nederland,** Callcenter 0900-1901 (15ct/min.)

Voor een snelle service verzoeken wij u om het volgende te vermelden:

Productomschrijving: Variabele hoekinstap Trento

B8090 – 51194155 / 33331037
B8090WS – 70567511 / 39956613
B8090C – 68165331 / 28384669
B8090CS – 13717463 / 21371865
B8090B – 46713949 / 42547161
B8090BS – 86067306 / 75104752

alsmede het

Artikelnummer waaronder u het artikel heeft besteld (zie factuur).

Informatie over de prestatieverklaring (DoP) conform de EU-bouwproductenverordening vindt u via www.aproductZ.com.

U kunt de prestatieverklaring (DoP) opvragen via het artikelnummer of desgevraagd schriftelijk ontvangen.

Imported by AproductZ GmbH Werner-Otto-Str. 1 – 7 22179 Hamburg Germany

