

Für Ersatzteilbestellungen und bei Reklamationen bitte nachfolgende Hinweise beachten.



Sehr geehrte(r) Kundin/Kunde.

Sollte ein Teil Ihres bestellten Produktes beschädigt sein oder fehlen, werden wir Ihnen entsprechenden Ersatz liefern. Bitte senden Sie das Produkt nicht zurück.

Bitte füllen Sie die Angaben zum Ersatzteil bzw. Ihrer Reklamation in den unten angegebenen Feldern aus und senden Sie dieses Formblatt ausgefüllt zurück.

Zur Rücksendung können Sie folgende Möglichkeiten wählen:

- per Fax an: +49-511-54742-51
- per e-mail(scan) an: info@relita.com
- per Post an unsere Rücksendadresse: Relita Dr.Woite GmbH & Co. KG, Eschenweg 3, 30855 Langenhagen.

Folgendes bitte ausfüllen:

Name: _____

Adresse: _____

Telefonnummer: _____

e-mail (falls vorhanden): _____

Kundennummer (bei Reklamationen immer ausfüllen): _____

Artikelnummer: _____

Modellbezeichnung: _____

Farbe/Beschaffenheit (entsprechendes bitte umkreisen oder unterstreichen):

natur weiss geölt lackiert

Benötigte Teile

bitte ergänzen Sie die Bezeichnung die Teilenummer entsprechend der Ihnen vorliegenden Aufbauanleitung

Produkt/Name	Teilenr./Schraubennr.	Bezeichnung/Maße	Anzahl
Schrank Luna (Beispiel)	14	2197x160x20	1

MONTAGEANLEITUNG ASSEMBLY INSTRUCTION





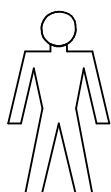
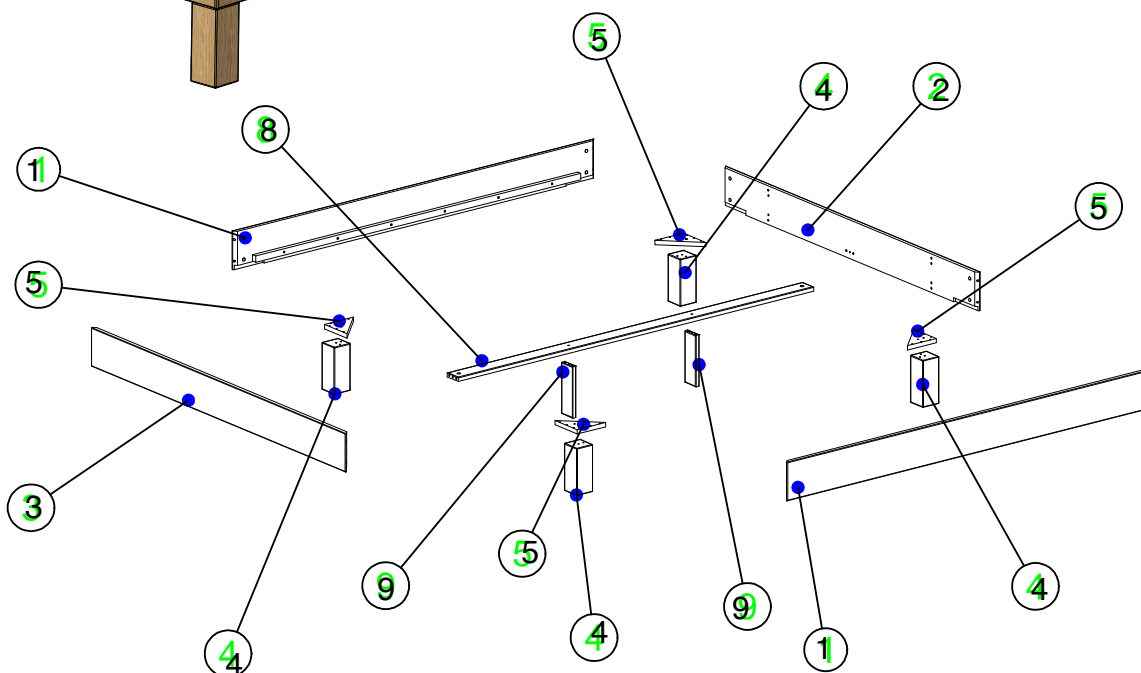
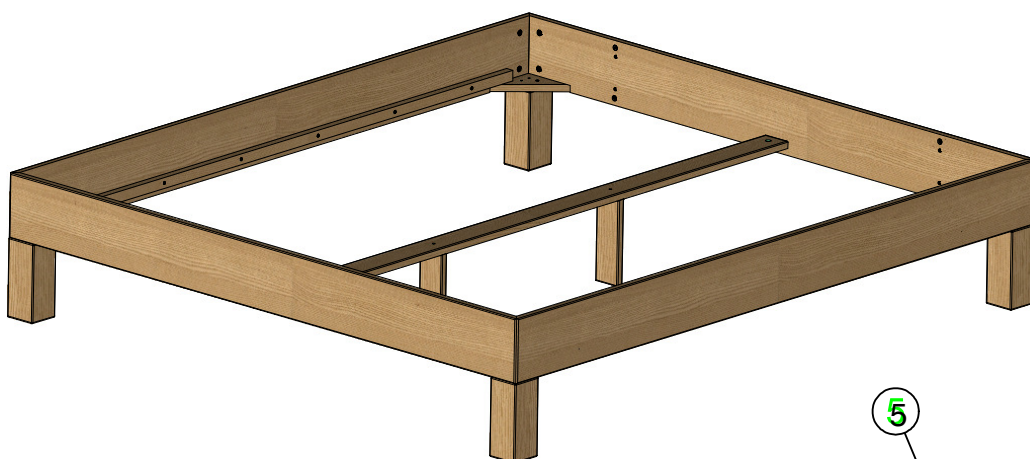
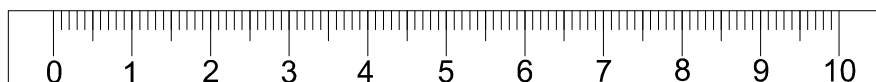

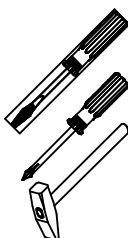

MANUELA 140/180 RELITA

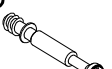

x2 90 min



A  \varnothing 8x30 8	B  16	C  2	D  2	D1  8	F  \varnothing 4x20 8	G  \varnothing 4x30 28	L  \varnothing 7x50 2
--	---	--	--	---	---	---	--

