

MEMPHIS 1KG6_42

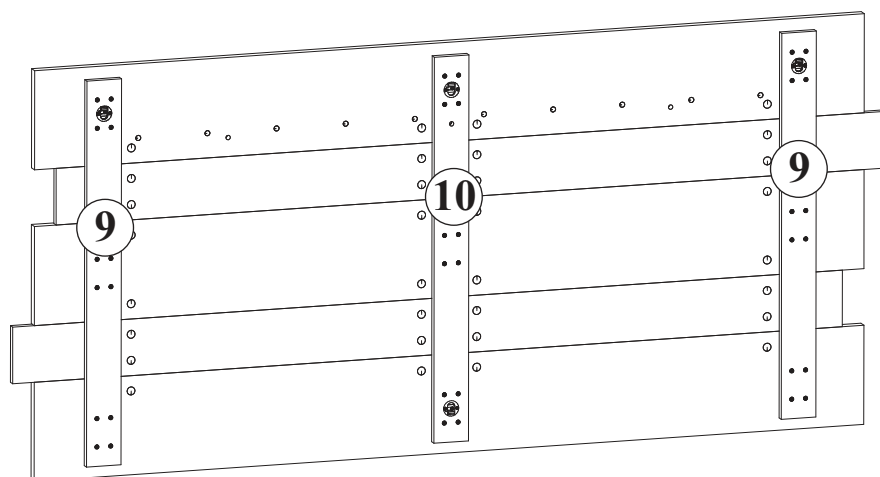

45 min

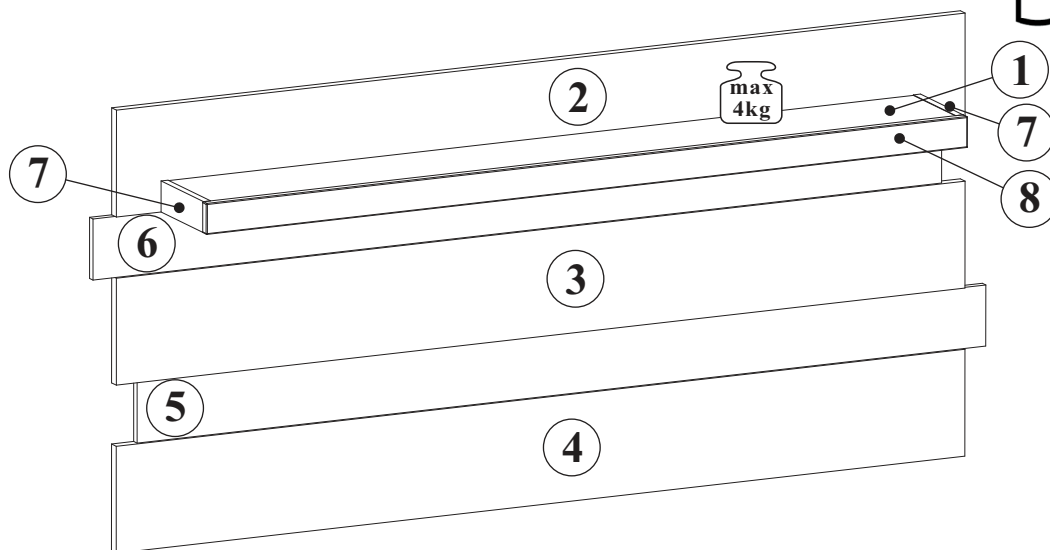

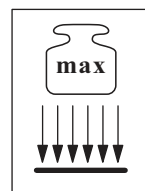
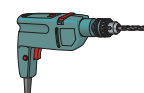
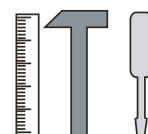

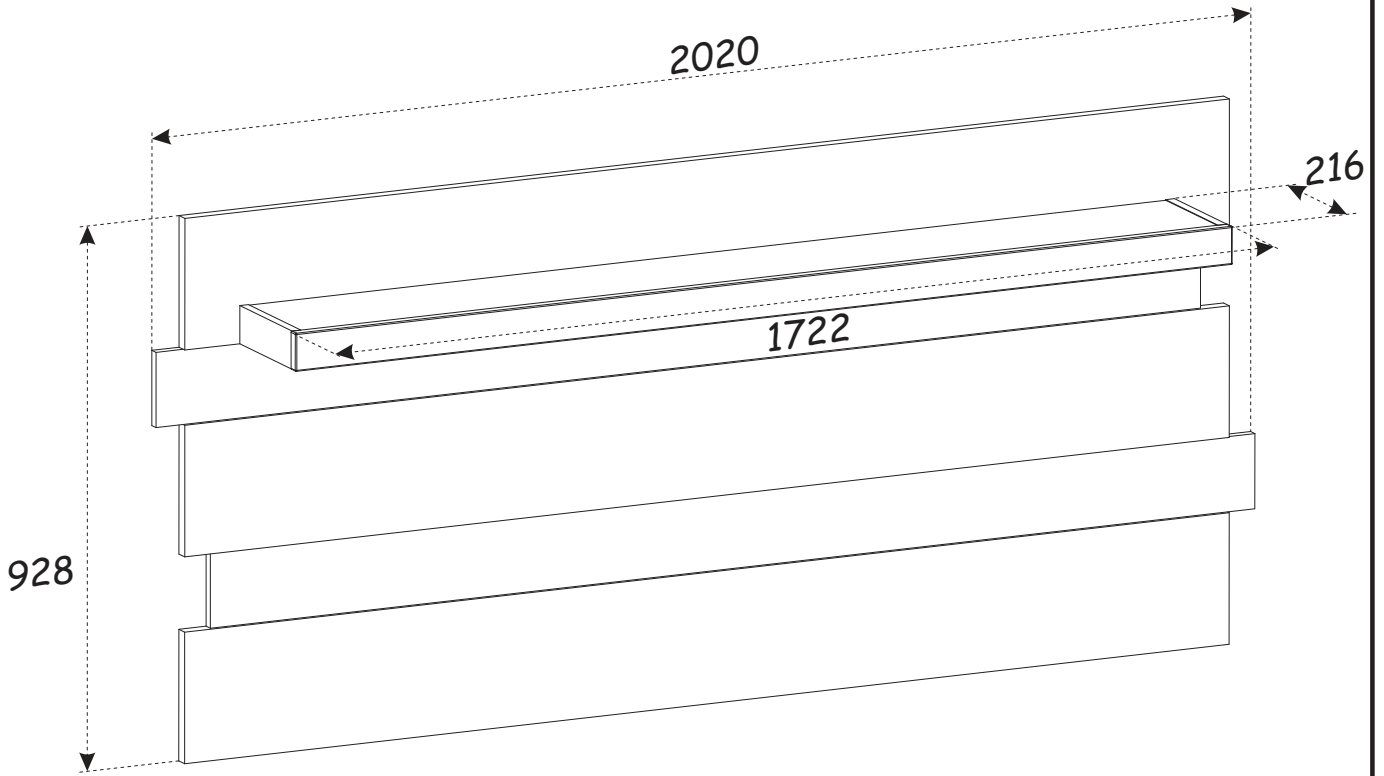

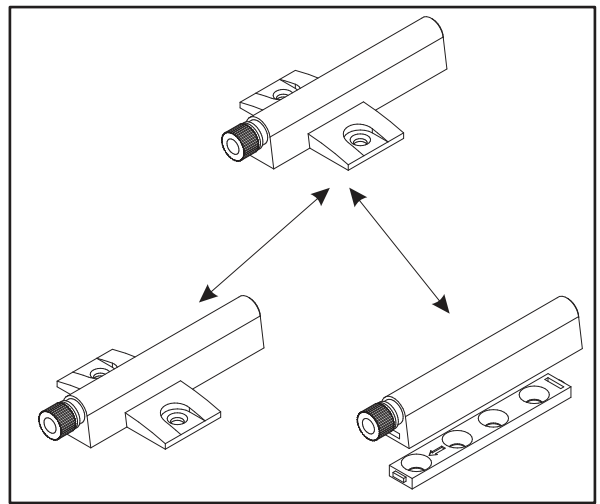
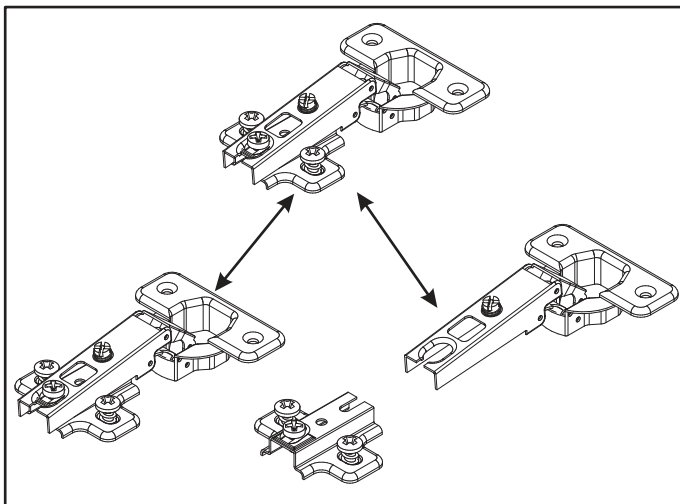
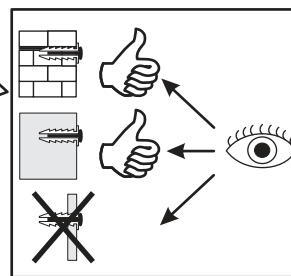
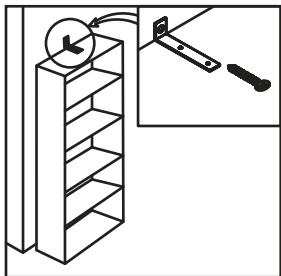
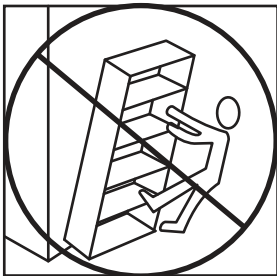
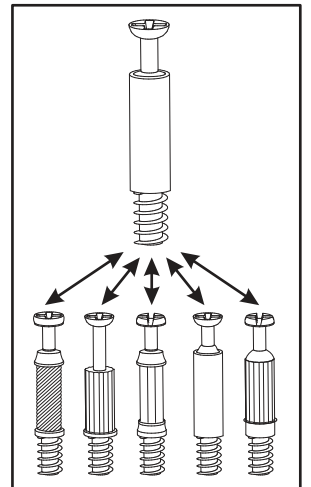
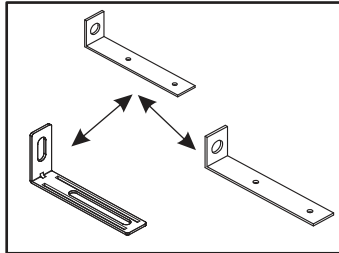
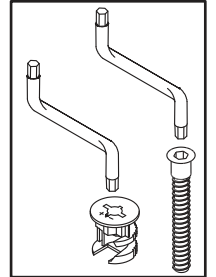
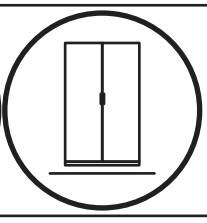
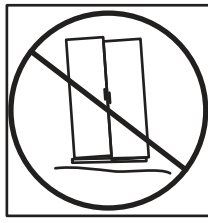
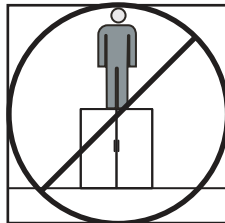
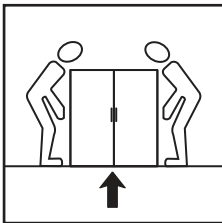
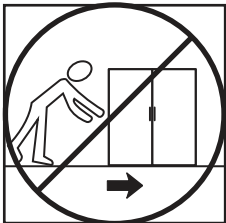
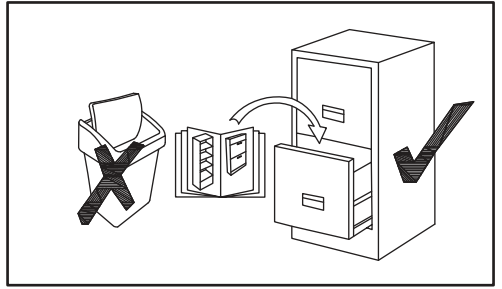
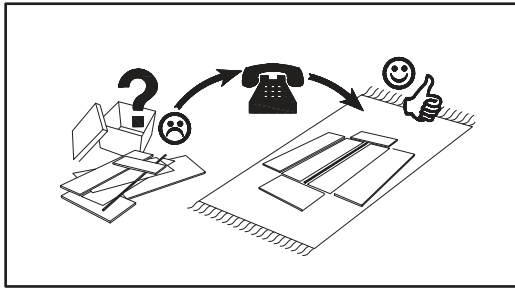
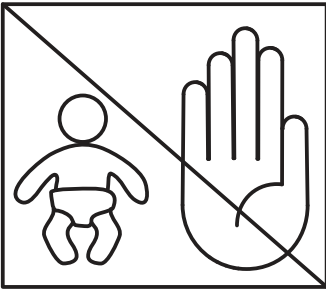
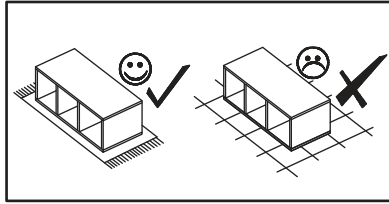
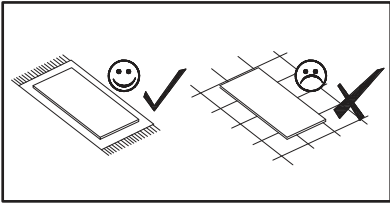



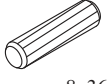
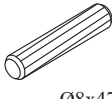
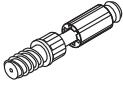

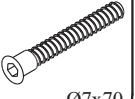
NO	Dim. [mm]			Col.-No	Qty
1	1686	198	16	2	1
2	1920	224	22	1	1
3	1920	224	22	1	1
4	1920	224	22	1	1
5	1920	128	16	2	1
6	1920	128	16	2	1
7	198	65	16	1	2
8	1722	65	18	1	1
9	872	80	16	1	2
10	872	80	16	1	1



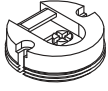

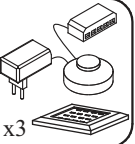
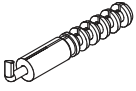
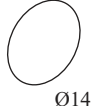
MEMPHIS 1KG6__42

A1 x14  ø8x36	A3 x12  Ø8x47	B4 x6 	B5 x38  ø15x12	G5 x38 	B13 x10  Ø7x70
G4 x10 	B2 x16  Ø7x62	UP6 x36  UPØ4x30	ZM1 x4 	D20 x8  ESØ6,3x9,5	SQ x1  x3
KR3 x4  Ø10	G12 x1  Ø14	G2 x1 			

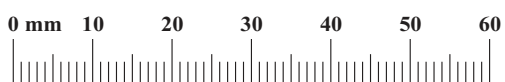

1

ZM1		D20	
x4		x8	ESØ6,3x9,5

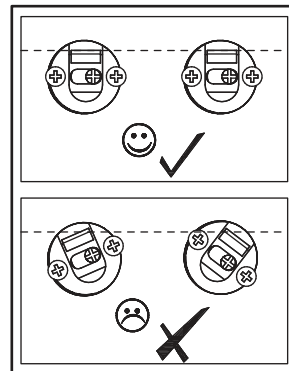
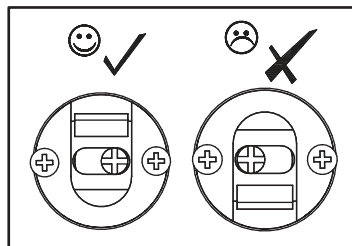
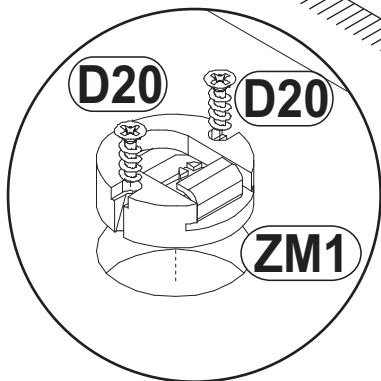
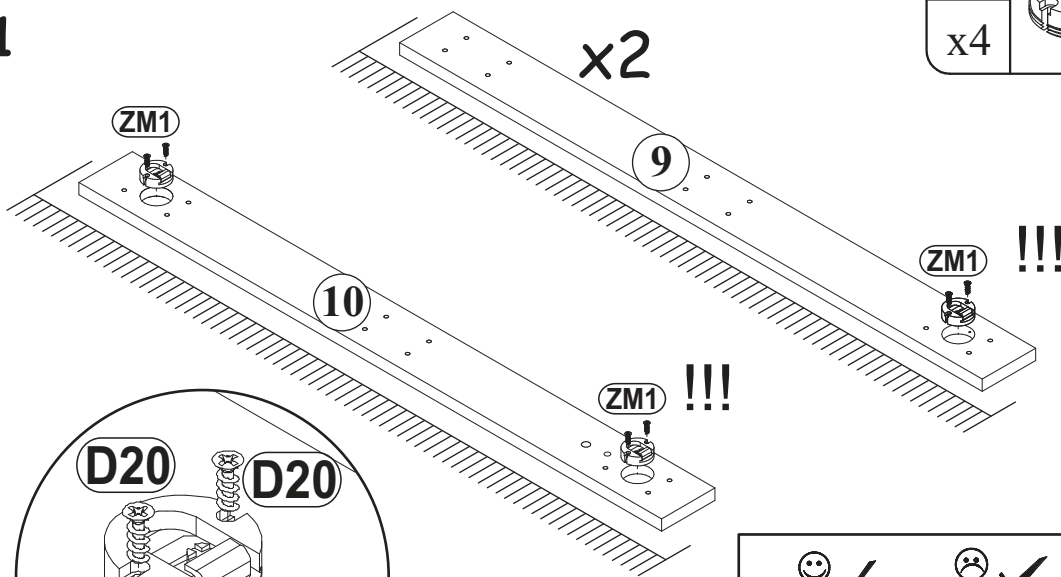

2

A3		B5	
x12	Ø8x47	x16	Ø15x12

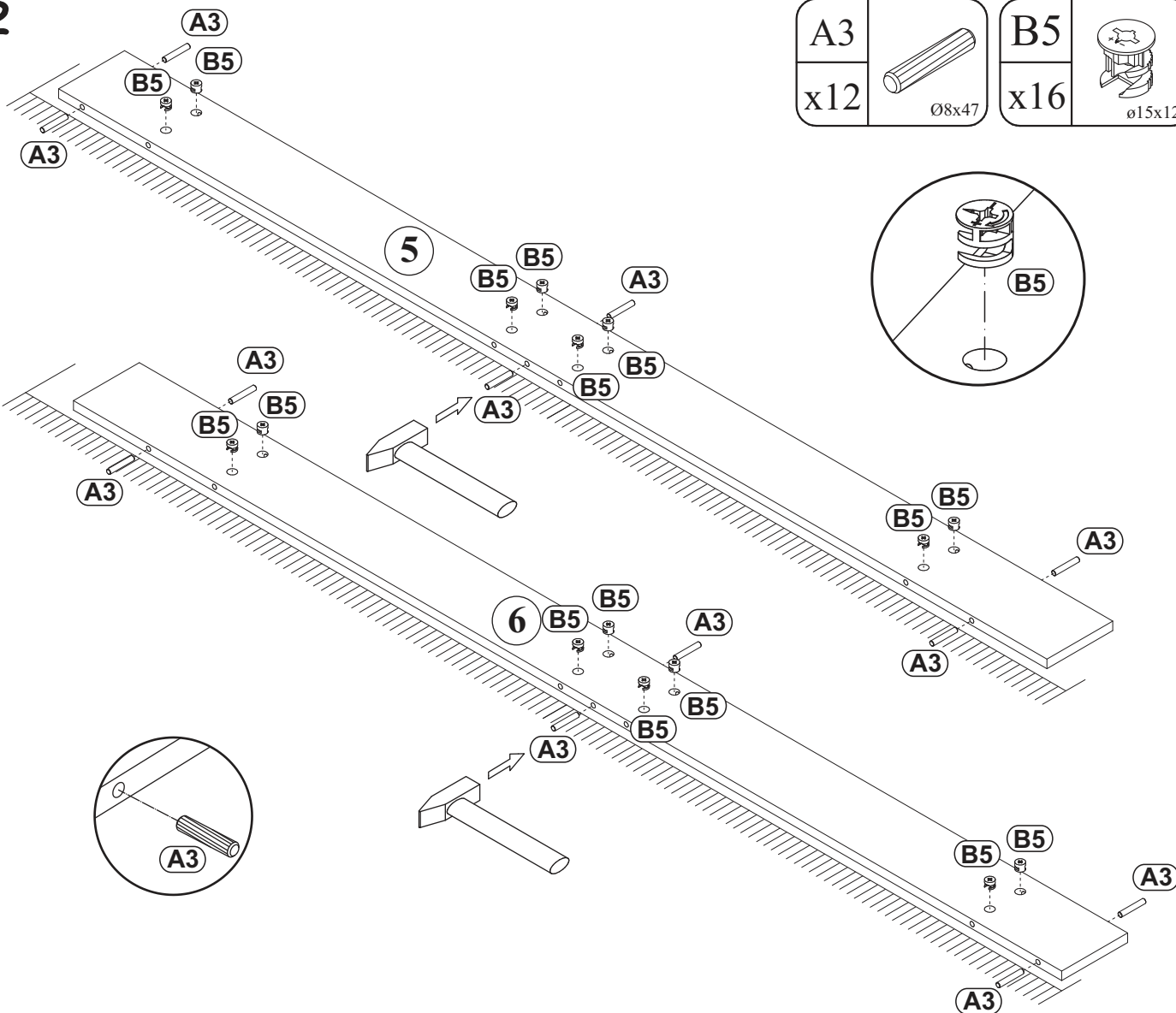

B5

x4



3

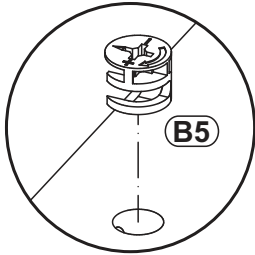
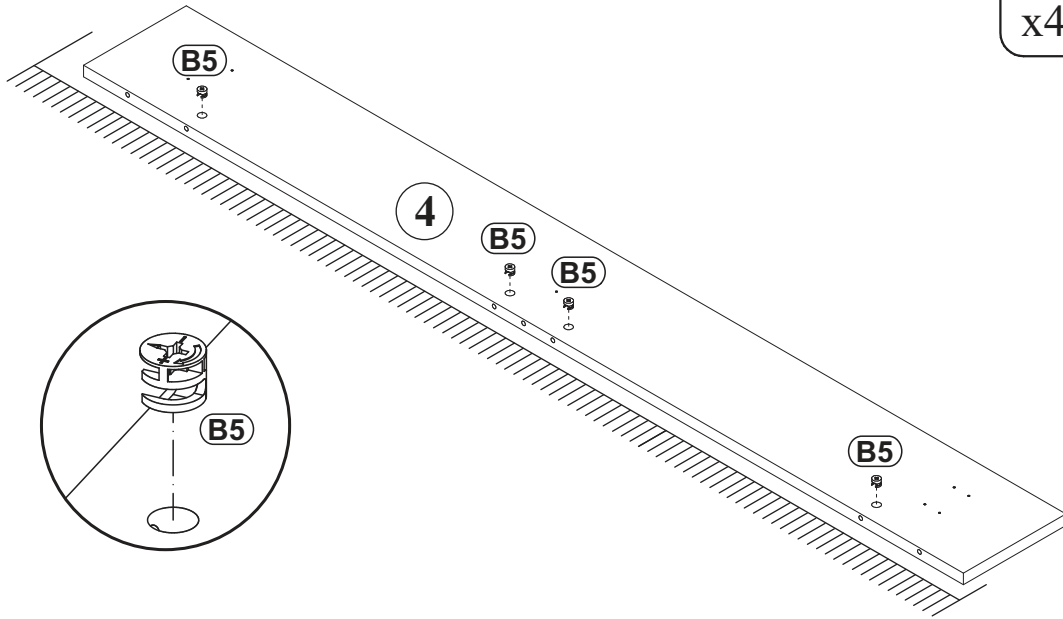

B5

x8



4

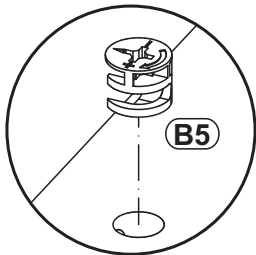
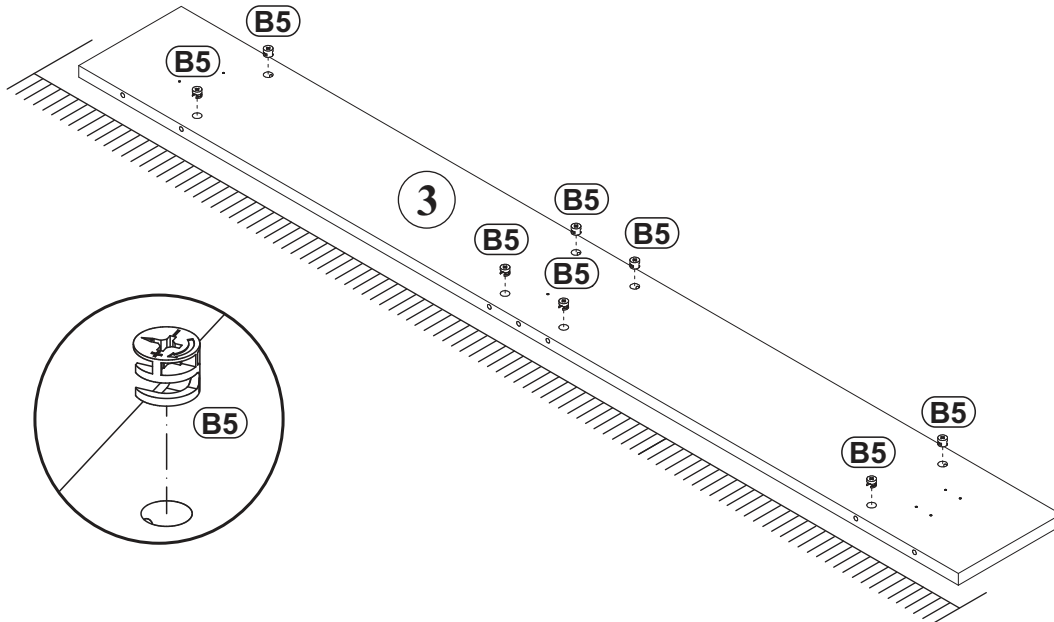



B5

x4

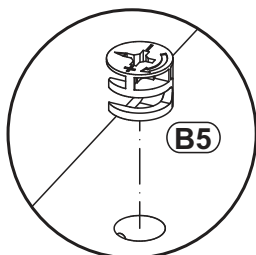
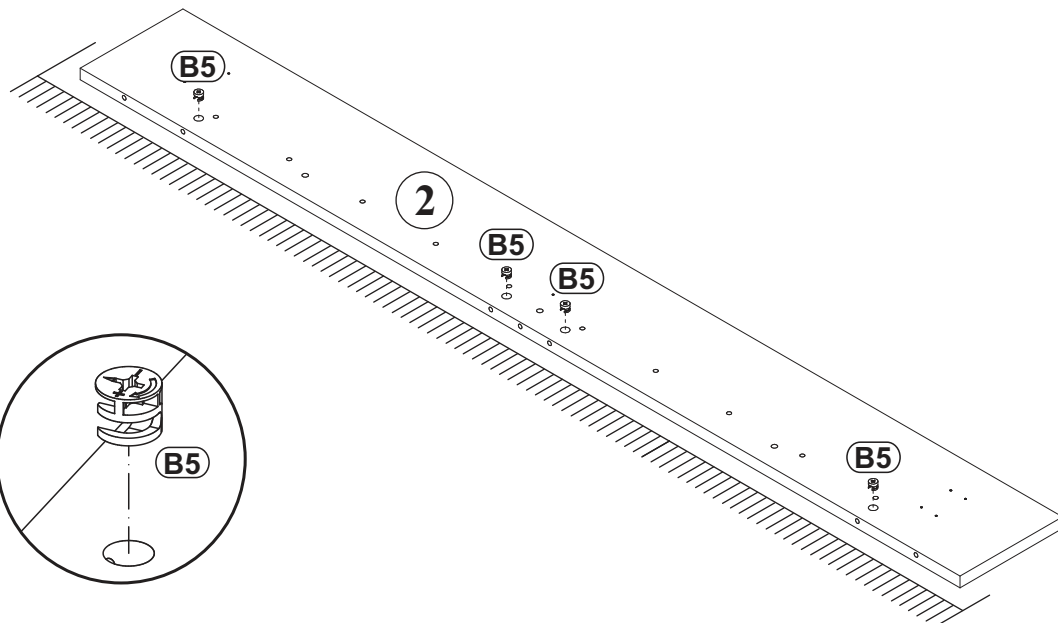

5





A1	
x14	ø8x36

B5	
x6	ø15x12

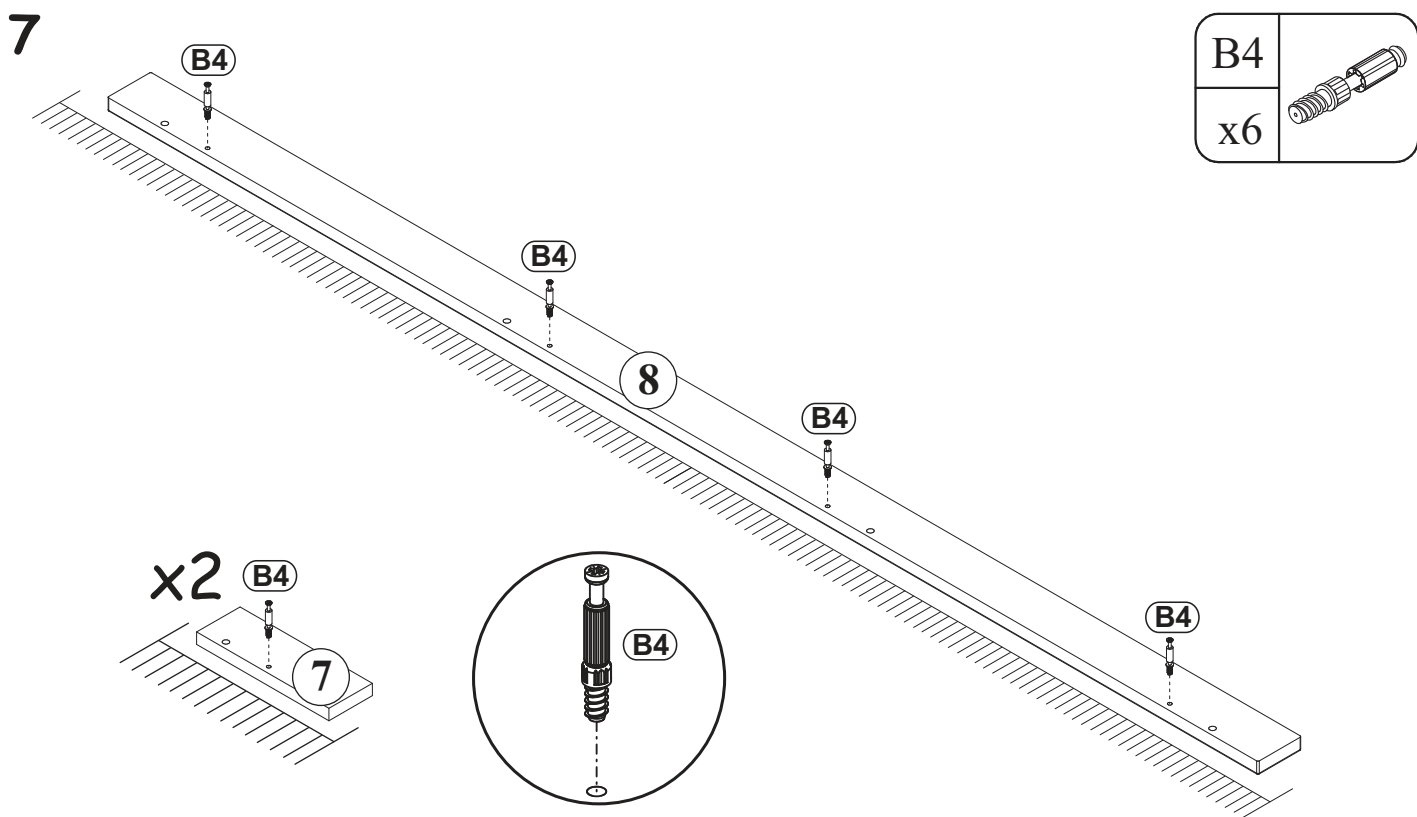
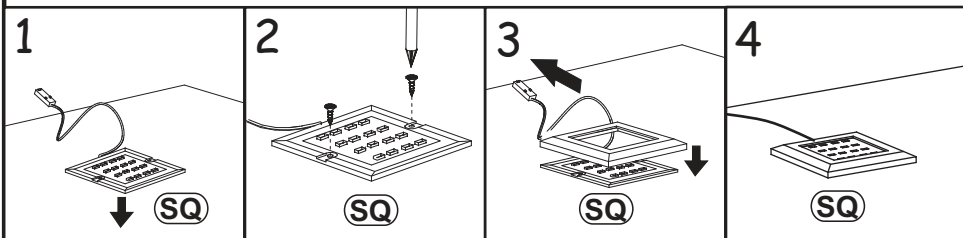
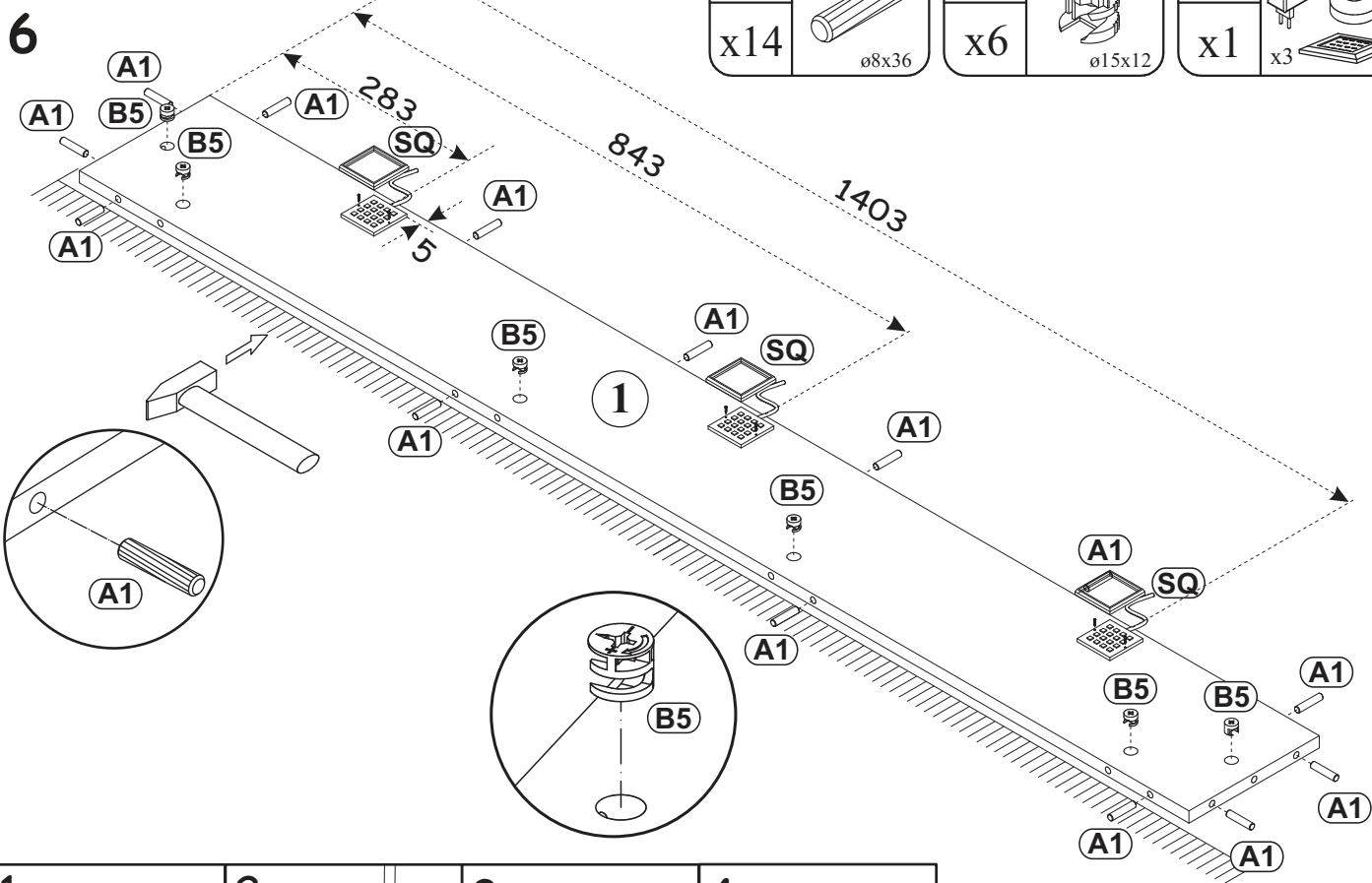
SQ	
x1	x3

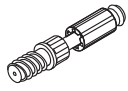

B4	
x6	

G5		B2	
x32		x16	Ø7x62

8

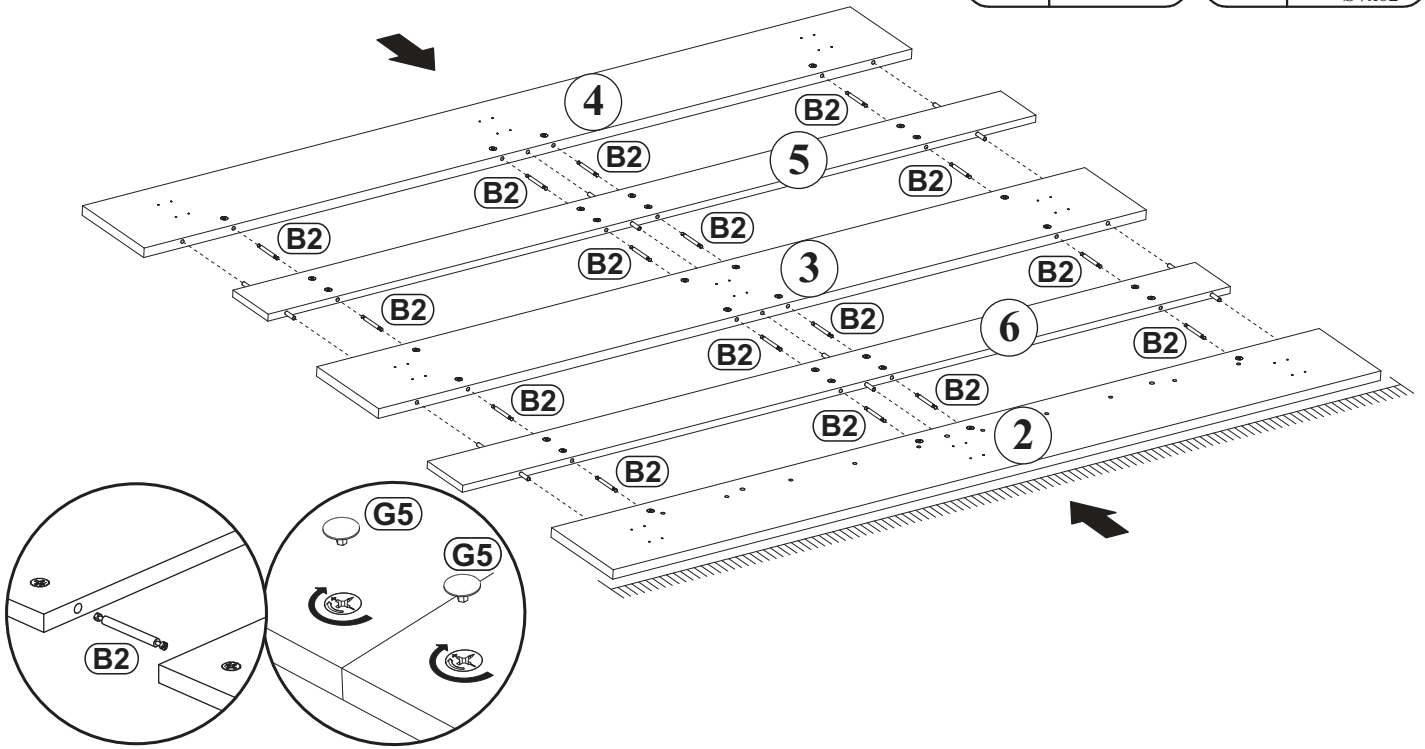

9

UP6	
x36	UPØ4x30

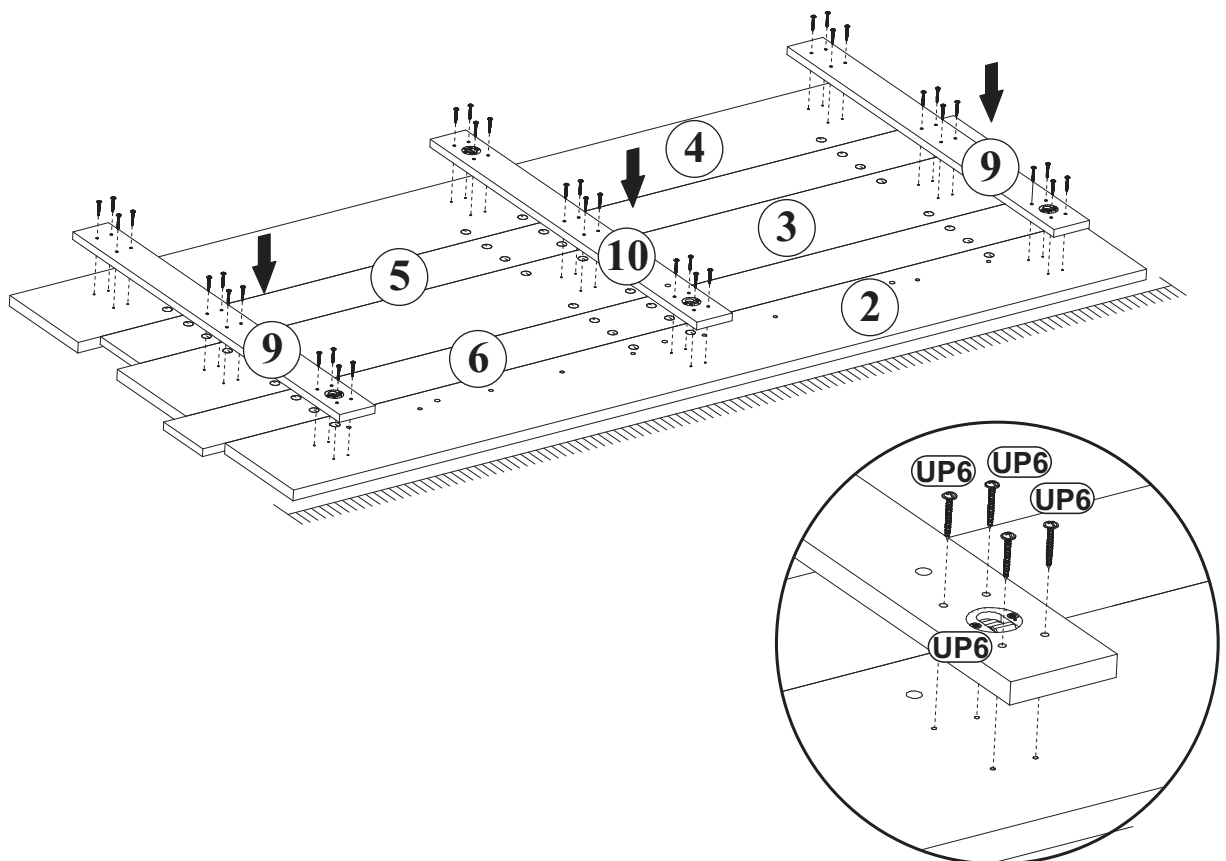

10

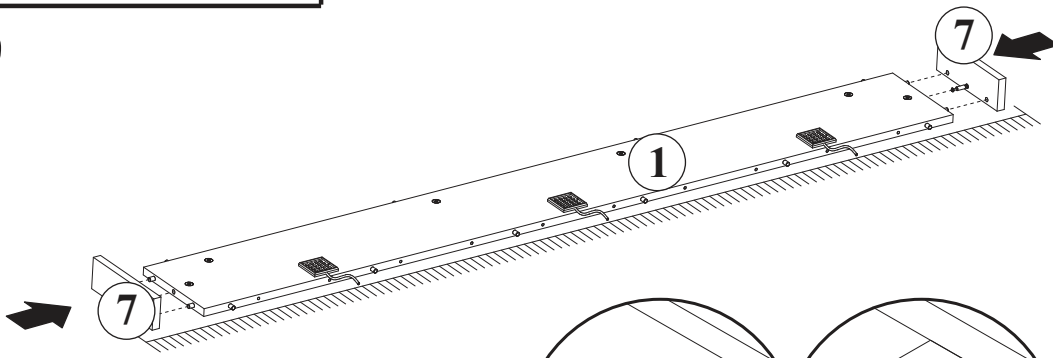

G5	
x2	

11

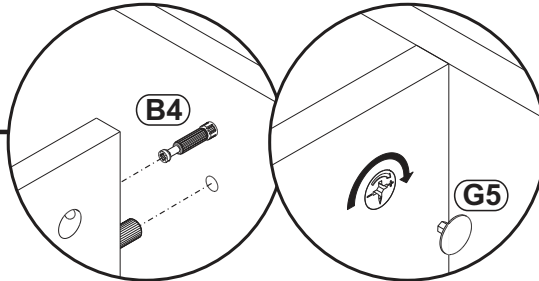

G5	
x4	

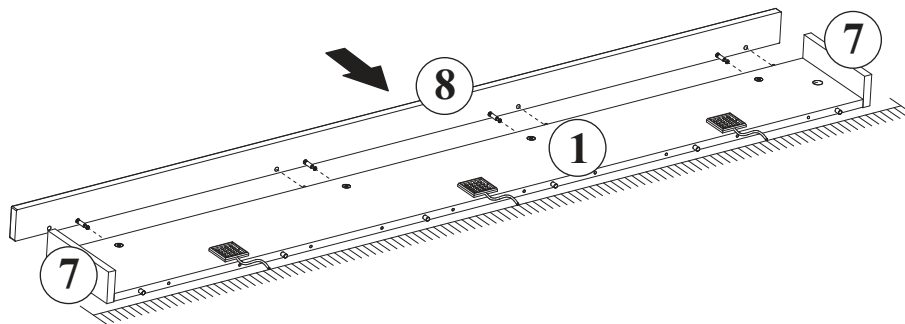

12

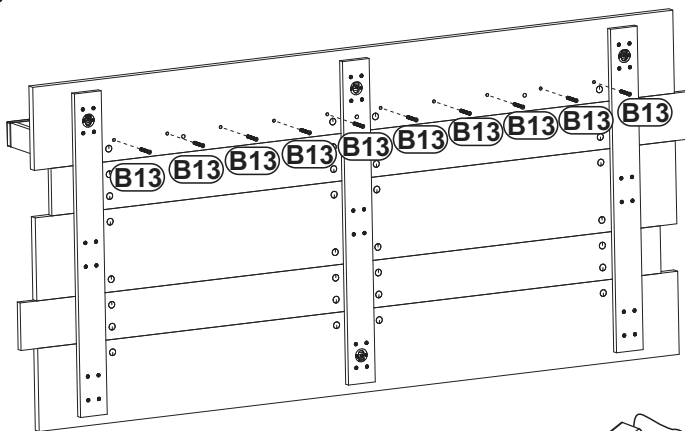

G4	
x10	

B13	
x10	Ø7x70

SQ	
x1	x3

180°

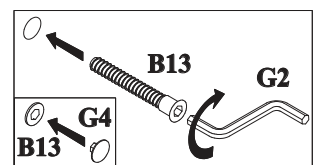
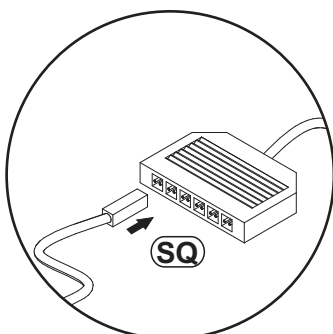
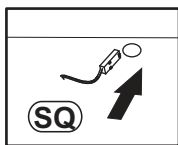
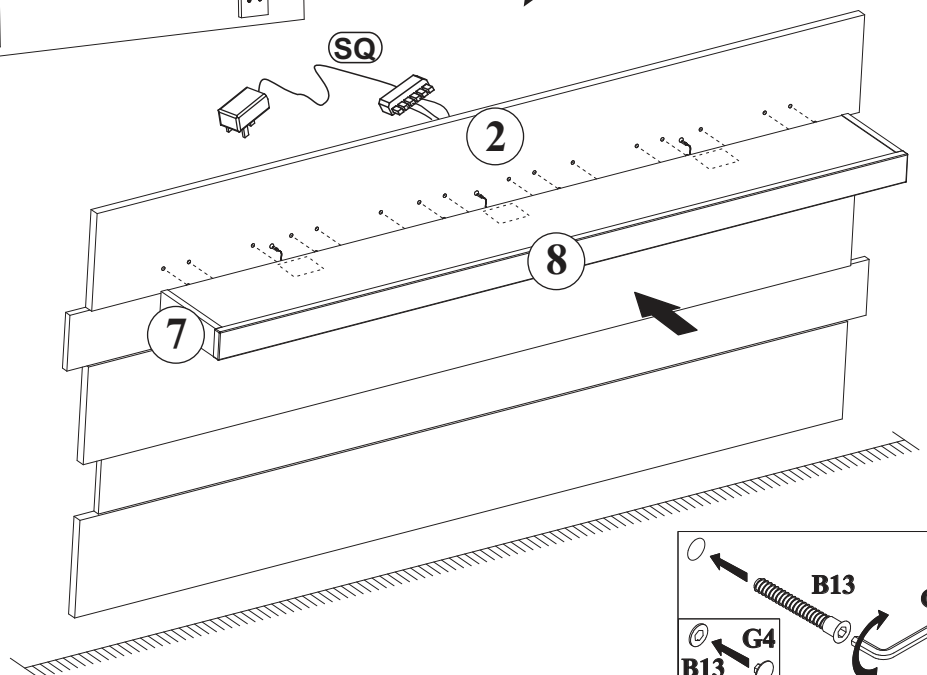

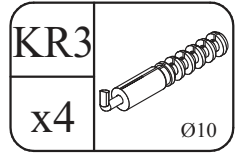

13

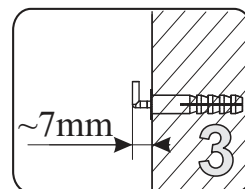
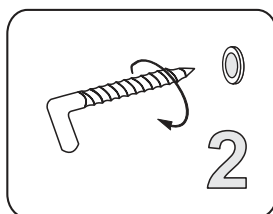
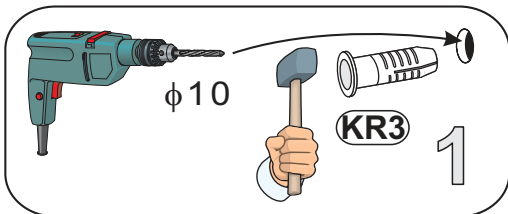
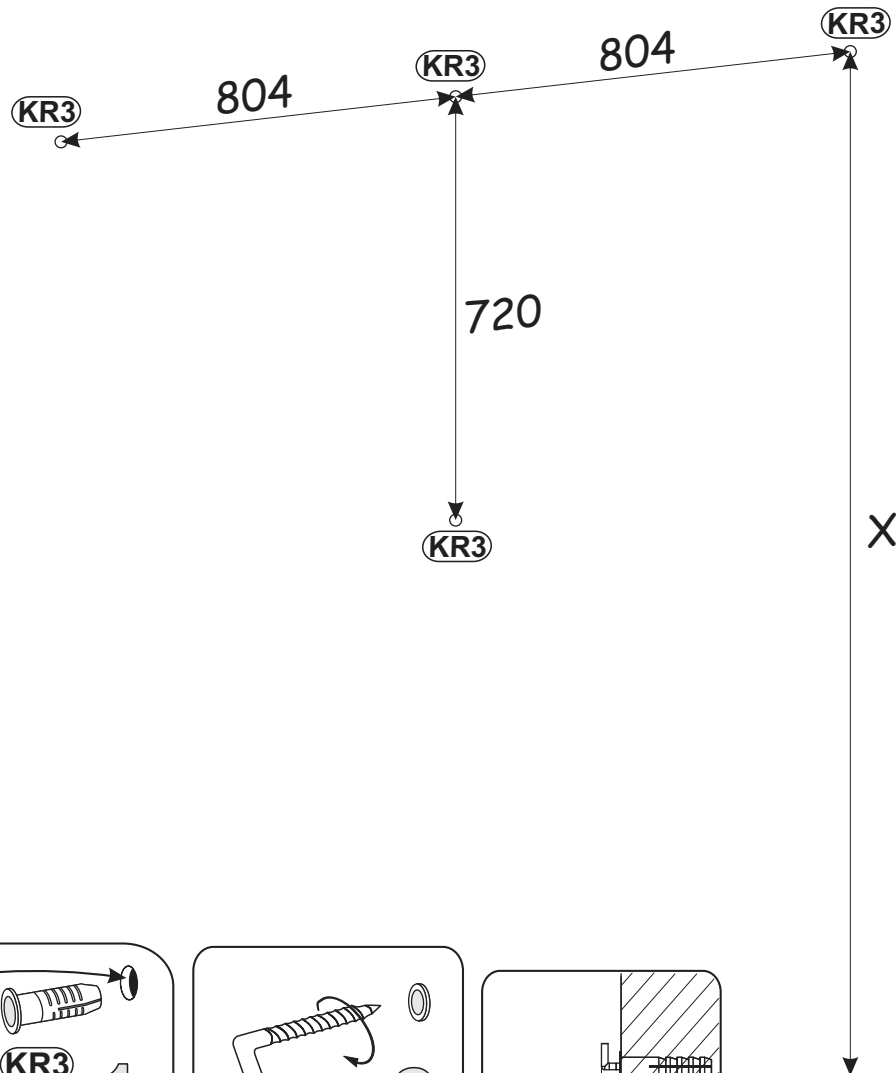
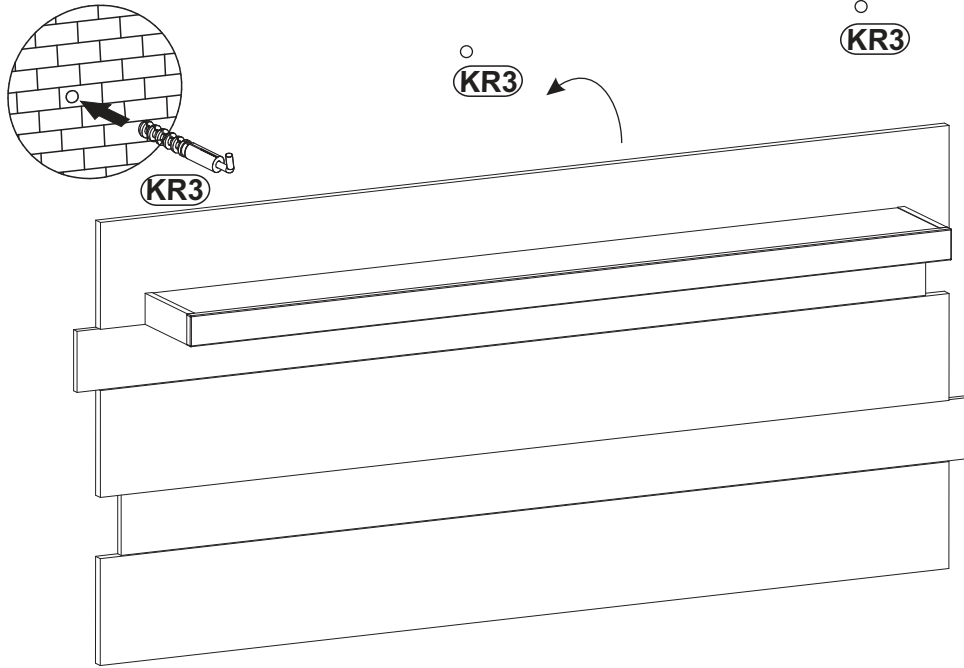

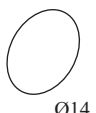
G12
x1 

14

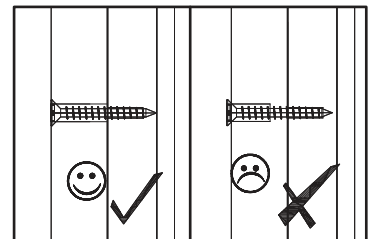
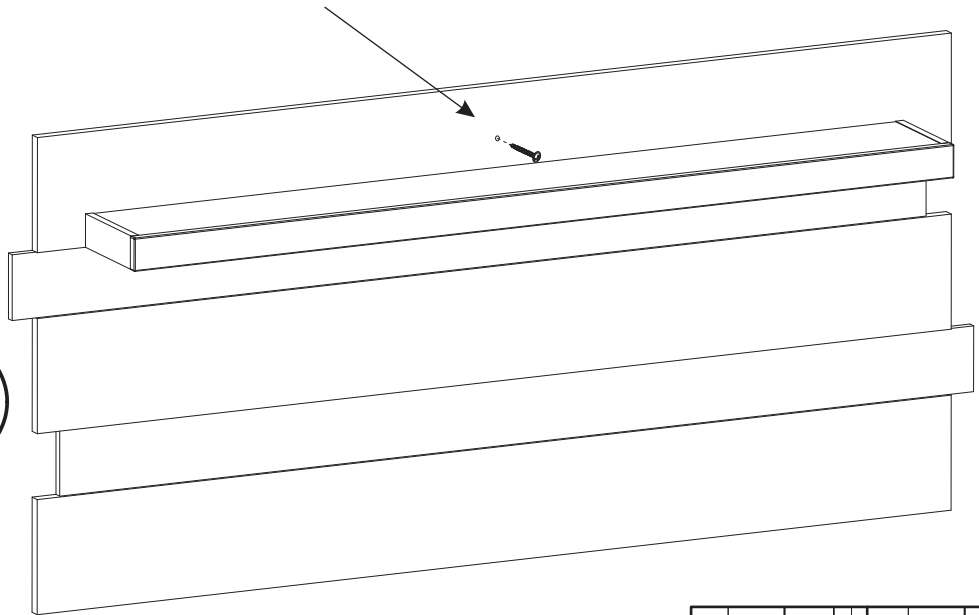
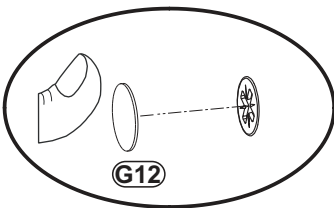
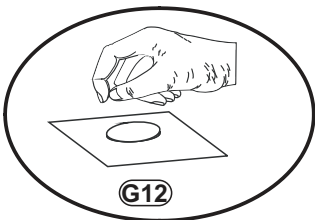
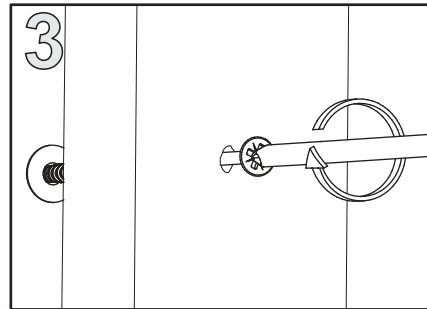
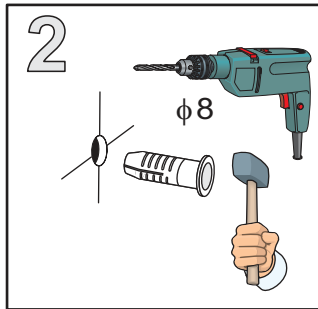
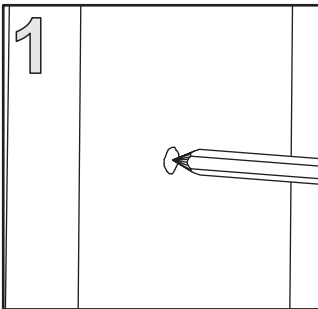
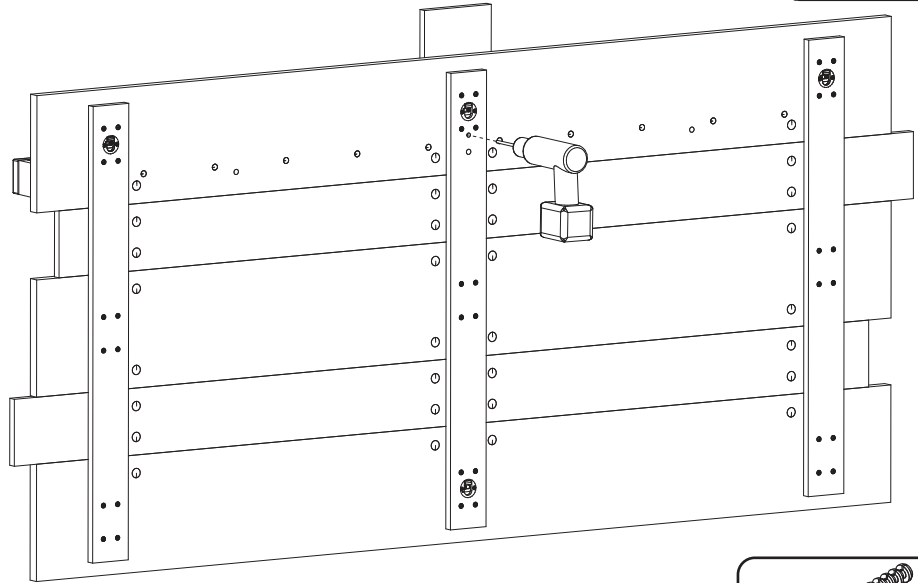
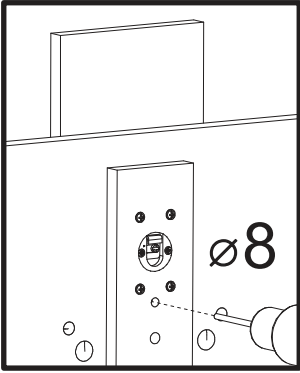

LED Spot Squere 2

787846 SQUERE2S-PCB-NW

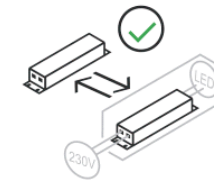
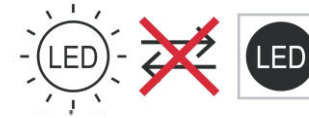
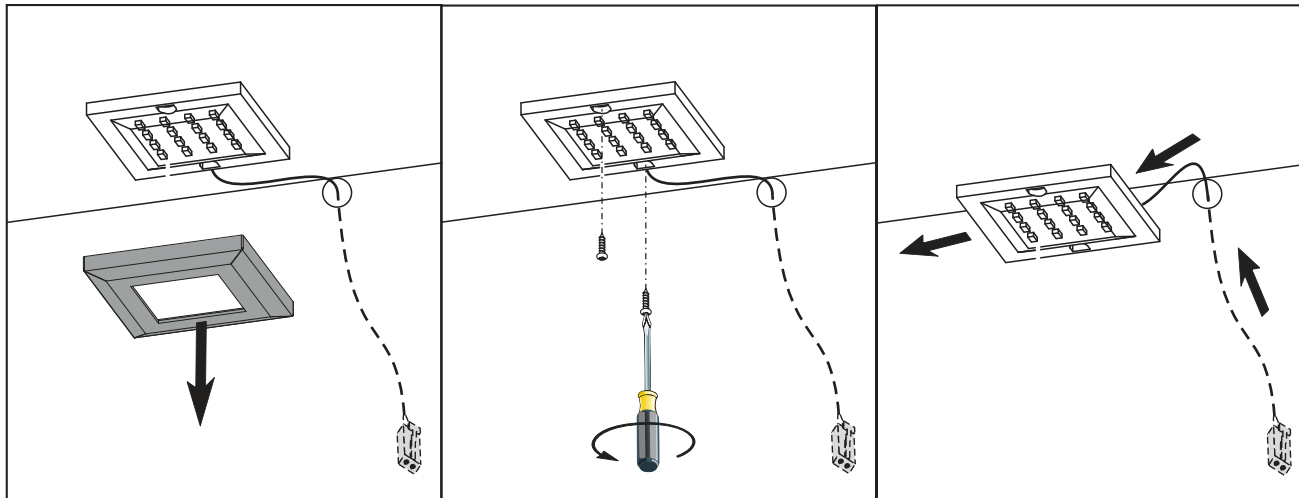

PL- Ten produkt zawiera źródła światła o klasie efektywności energetycznej „F”

DE- Diese Produkte enthalten Lichtquellen der Energieeffizienzklasse „F”

CS- Tento výrobek obsahuje světelný zdroj třídy energetické účinnosti „F”

DA- Dette produkt indeholder en lyskilde til energieffektivitetsklasse „F”

EL- Αυτό το προϊόν περιέχει μια πηγή φωτεινής πηγής ενεργειακής απόδοσης „F”

EN- This product contains a light sources of energy efficiency class „F”

ES- Este producto contiene una fuente de luz de clase de eficiencia energética „F”

ET- See toode sisaldab efektiivsusklassi valgusallikat energia "F”

FI- Tämä tuote sisältää energiatehokkuusluokan valonlähteen „F”

FR- Ce produit contient des sources lumineuses de classe d'efficacité „F”

HU- Ez a termék energiahatékonysági osztályú fényforrást tartalmaz „F”

IT- Questo prodotto contiene una sorgente luminosa di classe di efficienza energetica „F”

LT- Šiame gaminyje yra energijos vartojimo efektyvumo klasės šviesos šaltinis „F”

LV- Šis produkts satur gaismas avotu ar energoefektivitātes klasi „F”

RU- Этот продукт содержит источник света класса энергоэффективности „F”

PT- Este produto contém uma fonte de luz da classe de eficiência energética „F”

RO- Acest produs conține o sursă de lumină de clasă de eficiență energetică „F”

NL- Dit product bevat een lichtbron met energie-efficiëntieklasse „F”

SK- Tento výrobek obsahuje svetelný zdroj triedy energetickej účinnosti „F”

SLO- Ta izdelek vsebuje svetlobni vir razreda energijske učinkovitosti „F”

SV- Denna produkt innehåller en ljuskälla för energieffektivitetsklass „F”

TR- Bu ürün bir ışık kaynağı enerji verimliliği sınıfı içerir „F”

HR- Ovaj proizvod sadrži izvor svjetlosti razreda energetske učinkovitosti „F”

BG- Този продукт съдържа източник на светлина от клас на енергийна ефективност „F”